



ENTRELEC TERMINAL BLOCKS

Master catalog



ENTRELEC Terminal Blocks

Master catalog



SNK SERIES TERMINAL BLOCKS



DEDICATED APPLICATIONS TERMINAL BLOCKS



RGW RING LUG TERMINAL BLOCKS



DBL POWER DISTRIBUTION BLOCKS



ESSAILEC® TEST BLOCKS



RAILWAY APPLICATIONS TERMINAL BLOCKS

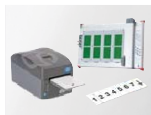

MARKING SOLUTIONS



EASY RAIL DESIGNER 3D



SNK SERIES TERMINAL BLOCKS

PI-Spring, screw clamp and
pluggable technologies

ENTRELEC Terminal Blocks

Here is the first SNK Series Terminal Blocks interactive catalog which contains numerous new functionalities:

- ✓ Additional information, about the product pages: in the table, click on the product order code to obtain the data sheet, the agreement and all technical information regarding that reference.
- ✓ A dedicated page to the SNK challenge videos and the SNK video

- ✓ A tab system on the side of the Flipbook helps you navigate easily inside the catalog
- ✓ Interactive summaries. One click on an entry leads you to the desired page.

Receive one link only in your email to open the Flipbook; once opened, you can download the PDF, only if you need to. No overload in your email box nor on your hard drive.

ZK2.5 PI-Spring terminal blocks

Feed-through - 5.2 mm 0.205 in spacing



2.5 mm²
12 AWG

Description
Combine high performance with compact dimensions:
- 1000 V AC / DC IEC 600 V UL
- Opt for the best marking visibility thanks to the up-front, flat marker zone, which lets you mark up to eight digits or increase the font size.

Ordering details

Description	Color	Type	Part Number	Pkg qty	Weight (1 post) g
Feed-through 2 connections	Grey	ZK2.5	1SNK705010R0000	50	5,50
	Blue	ZK2.5-BL	1SNK705030R0000	50	5,50
	Orange	ZK2.5-OR	1SNK705030R0000	50	5,50
	Yellow	ZK2.5-YL	1SNK705060R0000	50	5,50
	Green	ZK2.5-GN	1SNK705061R0000	50	5,50
	Red	ZK2.5-RE	1SNK705062R0000	50	5,50
	White	ZK2.5-WH	1SNK705065R0000	50	5,50
	Black	ZK2.5-BK	1SNK705066R0000	50	5,50

Main technical data

Connecting capacity	IEC	UL - CSA	Rail	TH SS-7,5, TH SS-15
1 conductor per clamp	Rigid: Solid/Stranded Flexible without ferrule Flexible with non insulated ferrule Flexible with insulated ferrule	0.2 ... 4 mm ² 0.22 ... 2.5 mm ² 0.22 ... 2.5 mm ² 0.22 ... 2.5 mm ²	26 ... 12 AWG 26 ... 14 AWG 26 ... 14 AWG	Wire stripping length 11 mm 0.433 in
2 conductors per clamp	Flexible with twin ferrule	0.22 ... 0.5 mm ²	26 ... 20 AWG	Tool for flexible conductor without ferrule Flat screwdriver Ø 3.5 mm Ø 0.138 in
Rated current / Rated cross section		24 A / 2.5 mm ²	20 A / 12 AWG	
Rated short-time withstand current (I _s)		300 A	336 A	
Short Circuit Current Rating (with specific conditions)			100 kA	
Rated voltage		1000 V	600 V	
Impulse withstand voltage		6000 V		
Protection		IP20	NEMA 1	

Mounting instructions

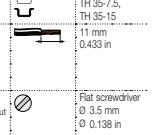

Increased safety Ex e IEC EN 60079-7 - IM2 II 2 GD Ex eb IIC/C

The connecting capacity data for one Rigid, Solid/Stranded, or one Flexible conductor (when applicable) is mandatory information required by IEC, UL and CSA standards (Copper conductors). All other data are provided as supplementary information only. For more details, please consult our CE, UL or CSA certificates and technical datasheet available on <http://www.te.com>

Accessories

Description	Color	Type	Part Number	Pkg qty	Weight (1 post) g
1 End stops	Dark grey	BAZ1	1SNK900002R0000	50	5,30
2 End sections	Dark grey	EPK2.5	1SNK705010R0000	50	1,80
3 Jumper bars	Orange	JBS-3	1SNK905302R0000	50	1,30
	Orange	JBS-3	1SNK905303R0000	50	2,00
	Orange	JBS-4	1SNK905304R0000	50	2,70
	Orange	JBS-5	1SNK905305R0000	50	3,50
	Orange	JBS-10	1SNK905310R0000	30	7,10
4 Cross spacing jumpers	Orange	JBS-50	1SNK905350R0000	10	36,00
5 Circuit separators	Dark grey	CS-R2	1SNK900106R0000	20	3,80
6 Test adapters	Dark grey	TP2	1SNK900203R0000	20	1,70
	Dark grey	TP4	1SNK900205R0000	20	2,40
7 Test connectors	Dark grey	TCS	1SNK900200R0000	10	5,20
	Dark grey	TCS-R1	1SNK900201R0000	10	5,20
8 Shield connectors	White	SNBP	1SNK900601R0000	20	4,10
	White	MS-CRM 13 41760	1SNB041760R0512	1960	0,23
9 Terminal block markers	White	MCS12	1SNK140000R0000	22	9,00
	White	MCS12PA	1SNK149999R0000	20	10,00
	Grey	UMH	1SNK900611R0000	10	0,20

Complete list of accessories is indicated in the terminal block datasheet including end stops. Some accessories such as jumper bars may modify the terminal block's ratings. Complete information available in the accessories section of the catalog.

Ground PI-Spring terminal blocks

Description	Color	Type	Part Number	Pkg qty	Weight (1 post) g
Ground	Green-yellow	ZK2.5-PE	1SNK705150R0000	20	10,00

Technical data valid for copper conductors only.

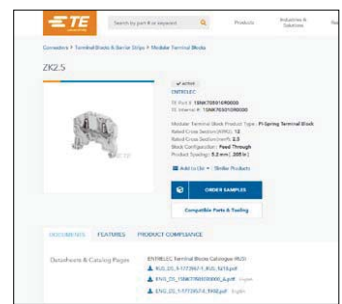

Click on the product part number to obtain detailed information and agreements.

Videos

SNK challenges

Discover how our SNK terminal blocks are able to overcome any kind of challenge!

What is the link between a terminal block, a washing machine, an egg and a child's play?
Find it out quickly by watching our 6 episodes bellow.
Get tips and experience moments of suspense and fun!

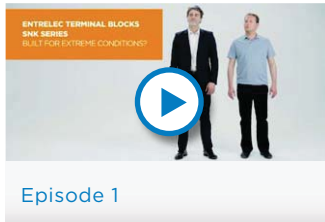

Episode 1

Built for extreme conditions?



Episode 2

So fast to connect?



Episode 3

Available everywhere on time for everyone?



Episode 4

So efficient marking?



Episode 5

Common accessories for all technologies?



Episode 6

Mounting is a child's play?

SNK video



SNK Series - The innovative range.

The innovative SNK series is available in PI-Spring (Push-In and Spring), screw clamp and pluggable technologies with common accessories. Qualified for worldwide applications and severe environments such as hazardous locations, railways, marine and solar.



SNK series, terminal blocks

PI-Spring, screw clamp and pluggable technologies

<u>Ranges and technologies presentation</u>	2	1
<u>PI-Spring terminal blocks</u>	13	2
<u>Screw clamp terminal blocks</u>	71	3
<u>Pluggable terminal blocks</u>	161	4
<u>Accessories</u>	195	5
<u>Marking solutions</u>	237	6
<u>Index</u>	270	7

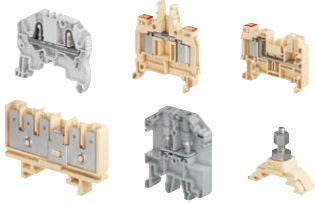

ENTRELEC terminal blocks offering

TE Connectivity proposes one of the largest connection offering on the market with various technologies: screw, PI-Spring, spring, IDC, pluggable, stud, etc. Technologies found in over 8000 products & solutions.

	SNK & SNA standard terminal blocks		Specific technologies		Terminal blocks for railway applications
					
Scope	Qualified for worldwide applications and severe environments (such as hazardous locations, railways, marine and solar applications..). From 0.2 to 300 mm ² .		Specific terminal blocks and technologies for dedicated applications and markets.		The largest offering on the market for rolling stock and infrastructures.
Product families & functions	SNK PI-Spring technology 2.5 to 16 mm ² 12 to 4 AWG	Feed-through Multi-deck Ground Disconnect for fuses Component holder	ADO System® (IDC) 0.22 to 4 mm ² 24 to 12 AWG	ADO-ADO or ADO-screw clamp Feed-through / Multi-deck / Ground / Disconnect / for fuses / Component holder	SNK PI-Spring technology 2.5 to 16 mm ² 12 to 4 AWG
			Safety (spring loaded) 0.22 to 10 mm ² 24 to 6 AWG	Feed-through Disconnect Test & measurement	SNK pluggable screw & PI-Spring technologies 2.5 to 4 mm ² 12 to 10 AWG
	SNK screw clamp technology 4 to 240 mm ² 12 to 500 Kcmil	Feed-through Multi-deck Ground Disconnect for fuses Test & measurement Marshalling Component holder	Stud 25 to 120 mm ² 2 AWG to 500 Kcmil	One stud 2 studs One stud - One wire-clamp	ADO System® (IDC) 1.5 to 4 mm ² 16 to 12 AWG
			Ring lug 2.5 to 25 mm ² 14 to 4 AWG	Feed-through Test & measurement	Stud 4 to 185 mm ²
	SNK pluggable screw & PI-Spring technologies 2.5 to 4 mm ² 12 to 10 AWG	Feed-through Multi-deck Ground	Miniblocks 1.5 to 6 mm ² 18 to 8 AWG	Screw clamp Spring ADO System® (IDC)	Quick-connect 2.5 to 6 mm ²
SNA Stud 35 to 300 mm ² 1 AWG to 1000 Kcmil	Feed-through Stud-stud Hybrid Stud-screw	Other types Test & measurement: with sliding link, blade, plug Pluggable: feed-through, double deck, disconnect Sensors/actuators: screw, spring, ADO system (IDC) Installation: screw, spring Protection: ground + neutral Component holders: screw, spring, ADO system (IDC)			

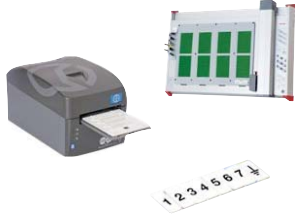

www.te.com

DBL power distribution blocks	ESSAILEC® test blocks	Interfast PLC pre-wiring system	Marking solutions
			
<p>The preferred choice for primary power distribution and solar applications.</p>	<p>Test blocks for safe and easy testing on secondary circuits of current and voltage transformers and sensors.</p>	<p>PLC pre-wiring system for fast, flexible, reliable connection of PLC's in process automation applications.</p>	<p>Markers & marking systems for all identification requirements in electrical panels.</p>
<p>From 80 A up to 550 A (IEC)</p> <p>Modular blocks: single pole, three & four poles, up to 12 outputs</p> <p>Terminal blocks types: 2 to 10 poles, up to 20 outputs</p>	<p>Current and voltage sockets & plugs</p> <p>Simultaneous testing of 1 to 4 independent circuits on the same socket</p> <p>Several testing principle such as "make before break" for safe current transformer testing</p> <p>Panel and switchboard mounting : base, flush, rack, TH35 rail</p> <p>Multicircuits sockets & plugs</p>	<p>Interfast PCB: Compact & standard modules</p> <p>Interfast MS: Modular system based on terminal block technology</p> <p>Functions:</p> <ul style="list-style-type: none"> - 1 to 4 wire connections (sensors) - Disconnect - Fuse - Signal indication - Relays - Optocouplers - Solenoid valve control - Galvanic isolation (2.5 kV). 	<p>Terminal block identification and group markers</p> <p>Wire and cable identification</p> <p>Component and equipment identification</p> <p>Panel identification</p> <p>Pre-printed markers for terminal blocks</p>

SNK series, terminal blocks

PI-Spring, screw clamp and pluggable technologies

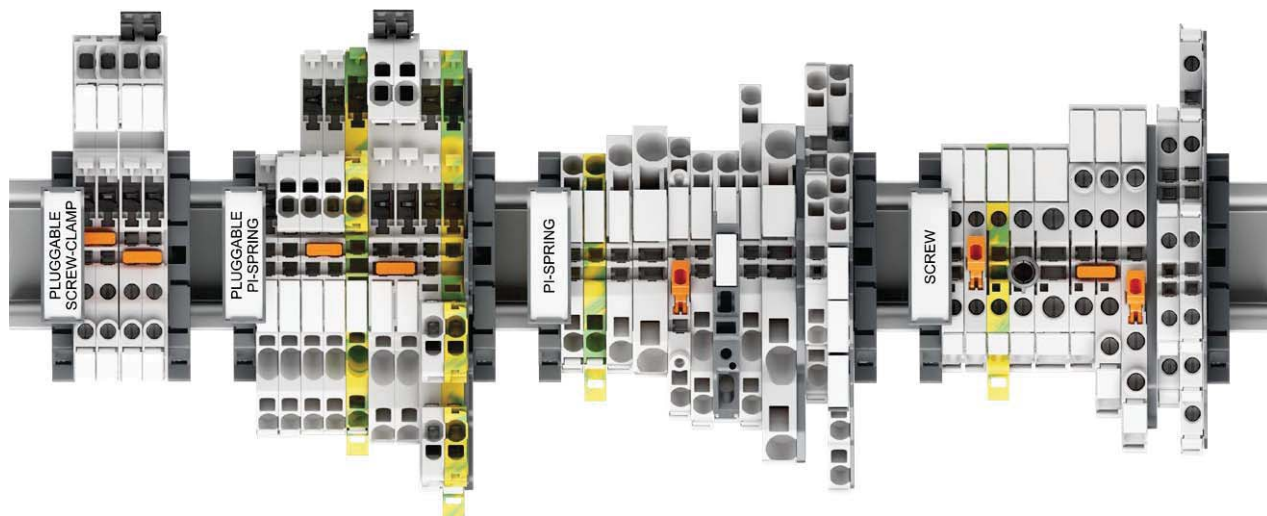

The innovative range available in PI-Spring (Push-In and Spring), screw clamp and pluggable technologies with common accessories.

Qualified for worldwide applications and severe environments such as hazardous locations, railways, marine and solar applications...



Speed up your projects

Smart connections, higher productivity

Up to 90% mounting time reduction with our PI-Spring, screw clamp and pluggable technologies.

Simplified selection and design

Intuitive codification, simplified catalogs, large technical data base.

Better project identification

20% larger marking area.

Pre-mark by hand or label before final marker installation.



Easy to install

Secured installation

Asymmetrical design avoid mounting and wiring errors. Zero-retightening with our technologies.

Faster accessories mounting

Benefit from screwless ground connection, jumpers, end stops.

Smart design facilitating assembly process

Mounting, wiring, testing... made easy.



Optimized logistics

50% less accessories needed

End sections, circuit separators fit several blocks.

Common accessories

PI-Spring, screw and pluggable ranges share the same accessories.

Simplified inventory management

Significant reduction of part numbers to manage.

PI-Spring technology

Two technologies in one connection

The patented design of TE Connectivity's PI-Spring can be used as a Push-in or traditional spring connection: Push-in and spring. The Push-in mode allows a direct one-step insertion of solid and flexible stranded wires with a ferrule, 50% faster than standard screw clamp technology.

Using the spring mode, very little effort is required to open the spring clamp with a screwdriver and insert the wire, which does not need a ferrule. The screwdriver locks in the terminal block after insertion, freeing up hands to manipulate wires or circuit drawings.

Features

All certification testing performed with non prepared wires, ensuring perfect connections with or without ferrules

Flat surface of the PI-Spring makes wire and screwdriver insertion smoother and easier

Dimensions, coating and shape of the linking bar designed to get the lowest and most stable electrical contact value

Very good electrical contact even in applications where vibration and shock are an issue, such as railway

Connection elasticity and design strictly controlled to ensure an easy and safe insertion of both conductor and screwdriver

The PI-Spring technology has successfully passed aging tests (30 days temperature rise test and 14 days heat cycling test) guaranteeing the perfect long-term contact quality of our screwless technology

Excellent pulling strength exceeding IEC standard requirements

Stainless steel PI-Spring for high corrosion resistance up to 1,000 hours salt mist resistance



From 0.2 mm² up to 16 mm²

From 26 AWG up to 4 AWG

Screw clamp technology

The heavy duty connection

Unique design, flies over time thanks to its reliability and safety

The TE Connectivity screw clamp technology is designed to avoid accidental releases due to vibrations, shocks or even abusive cable draw.

High density capacity

The screw clamp technology can fit up to two conductors per clamp which offers extended possibilities in electrical cabinets.

Features

The clamp is punched, which increases the number of screw threads by 30% meaning a high torque resistance

The TE Connectivity exclusive anti-release system creates a controlled locking-screw effect thanks to the 2 overlapping tabs that maintain the clamp parts. The screw is locked in total safety. The retightening campaigns are not needed anymore!

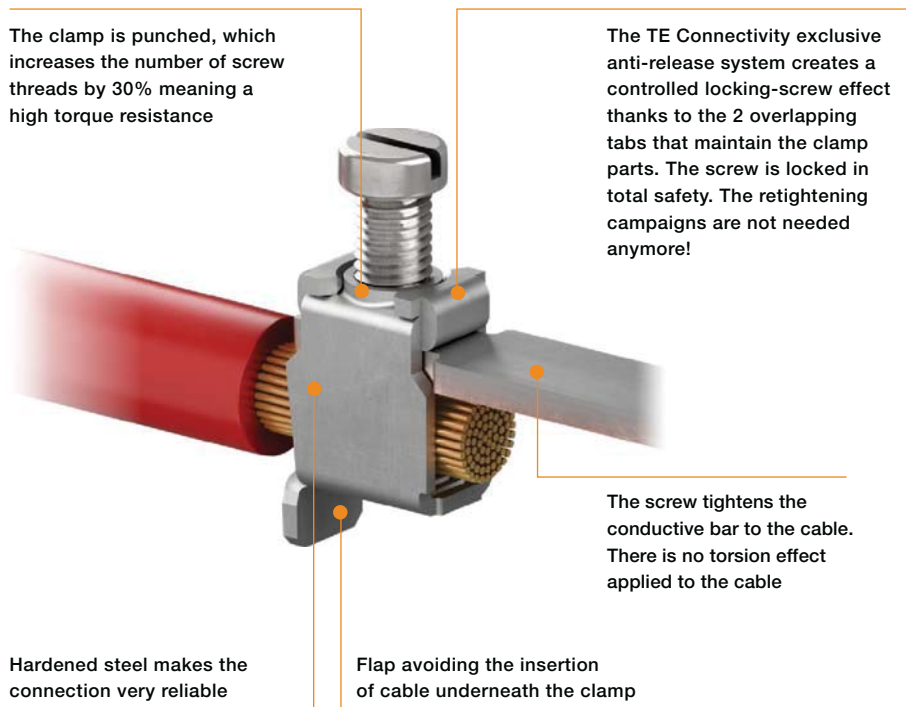

Hardened steel makes the connection very reliable

Flap avoiding the insertion of cable underneath the clamp

The screw tightens the conductive bar to the cable. There is no torsion effect applied to the cable

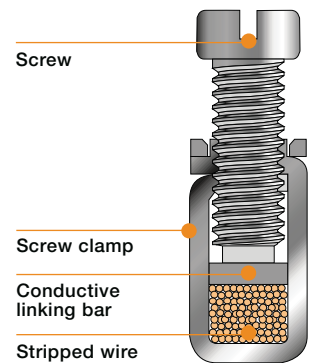

From 0.2 mm² up to 240 mm²

From 24 AWG up to 500 Kcmil

Pluggable technology

The pluggable technology allows "plug and play" connection. It enables productivity savings, wiring optimization thanks to serialized pre-wired plugs harnesses, as well as secured final commissioning.

Features

The TE Connectivity plug is the most compact on the market thanks to the punched U-shaped linking bar allowing direct conductor contact. TE Connectivity Patented design!

The lyres are made of copper alloy in order to offer maximized mechanical elasticity resistance (superior to 50 matings/unmatings)

The TE Connectivity pluggable terminal blocks have successfully performed the marine environmental tests and meet the most severe rolling stock requirements in 3 axis vibrations and shock resistance (for PI-Spring pluggable terminal blocks versions)

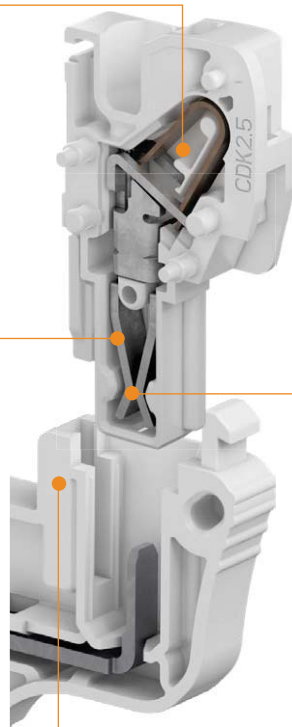

The chamfer shape guarantees auto-centering and mechanical integrity of the plug when inserted into the pluggable terminal block

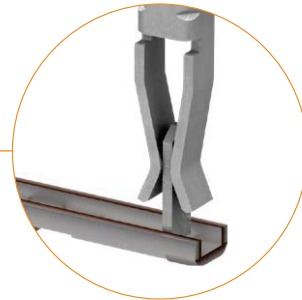

From 0.2 mm² up to 4 mm²

From 26 AWG up to 10 AWG

SNK series, terminal blocks

Applications

Qualified for worldwide markets, applications and for severe environments: vibration, shock, corrosion...

Industry and Commercial



SNK series, terminal blocks can be used worldwide in all types of industrial and commercial applications. All our products have CB, UL and CSA third party certificates delivered by independent laboratories. SNK series products are developed and qualified in accordance with the following international standards:
IEC 60947-1, IEC 60947-7-1, IEC 60947-7-2, IEC 60947-7-3, UL 1059, CSA C22.2 n°158-10.



Solar



Thanks to their high voltage rating (up to 1500 VDC per IEC 60947-7-1 and 1000 VDC per UL 1059), SNK terminal blocks are ideally suited for use in solar equipment.

Waste and Water



SNK terminal blocks are well adapted to harsh environment conditions such as waste and water applications. They have successfully passed the salt mist test in accordance with IEC 60068-2-11 (PI-Spring withstand up to >1000 h). SNK terminal blocks are also compliant with flowing mixed gas corrosion test per IEC 60068-2-60 (test duration: 21 days).

Railways



All SNK series products are suited to track-side fixed equipment.

For the more demanding environment of rolling stock applications, PI-Spring has been successfully tested in accordance with IEC 61373 requirements to resist high vibration and shock conditions (multi-axial waves, acceleration...).

The plastic material used is compliant with the flammability, smoke toxicity and opacity severe requirements of the traction segment and can be classified I2F2 per NF F 16-101 and NF F 16-102 standards; HL3 R22 per EN 45 545 standard and V0 per UL94 standard.

It complies with NFPA 130 per ASTM E 162 and ASTM E 662 standards tests and with FR238.103 and BSS 7239 standards.

The IRIS certificate guarantees the respect of international railway industry requirements.



Hazardous locations



SNK series is certified IEC Ex in accordance with IEC 60079-0 and IEC 60079-7 (increased safety "Exe") world international standards for products used in explosive atmospheres.

In order to serve specific local market requirements, some SNK products have additional local certifications such as: ATEX, UL hazardous Locations...

SNK products have successfully passed toughest tests like the thermal endurance test: 2 weeks in hot environment at 95 °C (+90% RH) followed by 2 weeks at 125 °C and one day cold environment test (-65 °C). This proves the high mechanical performances of the SNK products.



Marine



SNK products have proven their performance by successfully passing tests required for the most extreme conditions. (eg: salt mist, damp or dry heat and cold environments) per IEC 60068 standards.

In order to serve the worldwide marine markets requirements, SNK products have the following Marine certifications: BV Marine, DNV, RINA, RMRS.



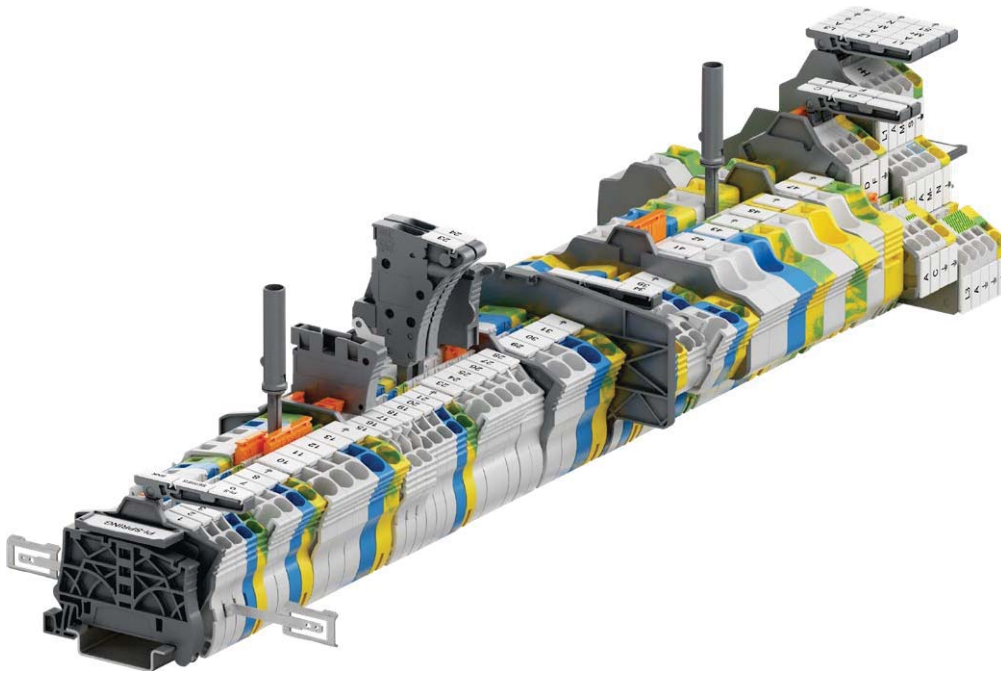

SNK series, terminal blocks

PI-Spring technology

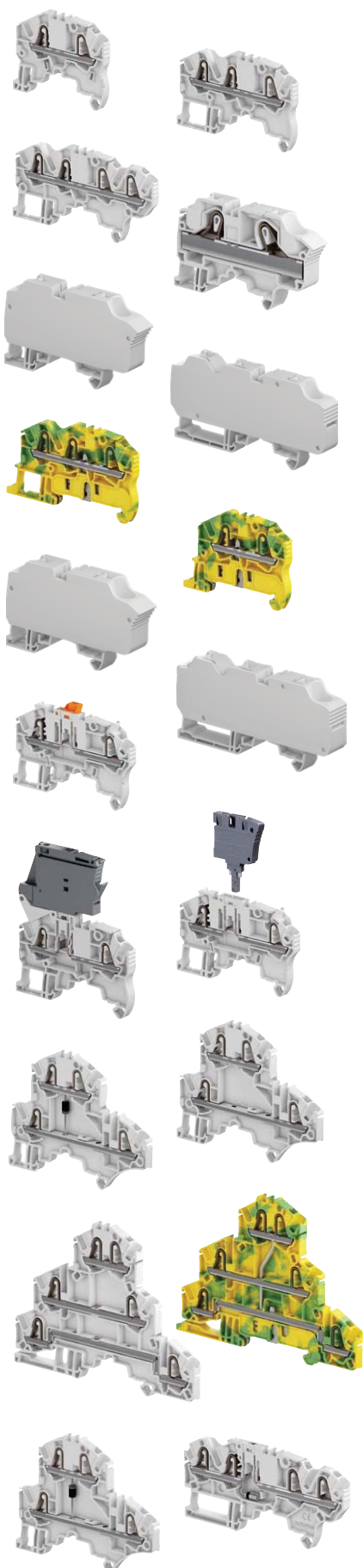

Technologies presentation		14
Overview		20
Feed-through		
2.5 mm ² / 12 AWG	ZK2.5	21
	ZK2.5-3P	with 3 connections 22
	ZK2.5-4P	with 4 connections 23
4 mm ² / 10 AWG	ZK4	24
	ZK4-3P	with 3 connections 25
	ZK4-4P	with 4 connections 26
6 mm ² / 8 AWG	ZK6	27
	ZK6-3P	with 3 connections 28
10 mm ² / 6 AWG	ZK10	29
	ZK10-PV	30
	ZK10-3P	with 3 connections 31
	ZK10-3P-PV	with 3 connections 32
16 mm ² / 4 AWG	ZK16	33
	ZK16-PV	34
	ZK16-3P	with 3 connections 35
	ZK16-3P-PV	with 3 connections 36
Ground		
2.5 mm ² / 12 AWG	ZK2.5-PE	37
	ZK2.5-PE-3P	with 3 connections 38
	ZP2.5-PE-4P	with 4 connections 39
4 mm ² / 10 AWG	ZK4-PE	40
	ZK4-PE-3P	with 3 connections 41
	ZK4-PE-4P	with 4 connections 42
6 mm ² / 8 AWG	ZK6-PE	43
	ZK6-PE-3P	with 3 connections 44
10 mm ² / 6 AWG	ZK10-PE	45
	ZK10-PE-3P	with 3 connections 46
16 mm ² / 4 AWG	ZK16-PE	47
	ZK16-PE-3P	with 3 connections 48
Disconnect with blade		
2.5 mm ² / 12 AWG	ZK2.5-S	with test sockets 49
	ZK2.5-S-4P	with test sockets 50
	ZK2.5-S-R1	51
Disconnect with plug		
2.5 mm ² / 12 AWG	ZK2.5-SP	with test sockets 52
	ZK2.5-SP-4P	with test sockets 53
For 5x20 fuses		
2.5 mm ² / 12 AWG	ZK2.5-SF	54
	ZK2.5-SF-R	with blown fuse indicator 55
Double deck		
2.5 mm ² / 12 AWG	ZK2.5-D2	2 feed-through circuits 56
	ZK2.5-D1	1 feed-through circuit 57
	ZK2.5-D2-PE	1 feed-through circuit and 1 ground circuit 58
	ZK2.5-D1-PE	1 ground circuit 59
Triple deck		
2.5 mm ² / 12 AWG	ZK2.5-T3	3 feed-through circuits 60
	ZK2.5-T1	1 feed-through circuit 61
	ZK2.5-L-L-PE	62
	ZK2.5-L-N-PE	2 feed-through circuits and 1 ground circuit 63
	ZK2.5-T1-PE	1 ground circuit 64
Component holder		
2.5 mm ² / 12 AWG	ZK2.5-CH-4P-LR	65
	ZK2.5-CH-4P-RL	66
	ZK2.5-D-CH-UD	67
	ZK2.5-D-CH-DU	68
	ZK2.5-D-CH2-DU-RL	69

PI-Spring technology - SNK series, terminal blocks

Features and benefits

The patented PI-Spring technology provides the benefits of both Push-In and Spring technologies in one connection

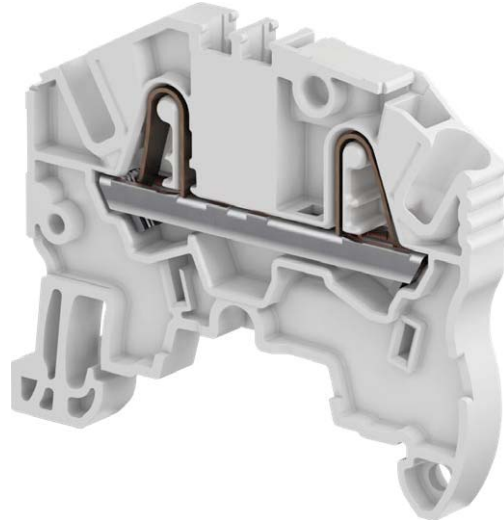

Speed up your projects

50% faster connection time with Push-in mode

Our Push-in connection technology allows:
A direct one step insertion with rigid and prepared flexible conductors.
Easy and quick insertion of the prepared flexible conductor or rigid conductor.

Reduced effort and conductor preparation time with spring mode

- Our connection requires minimal effort to insert wires with the screwdriver
- Flexible conductors preparation is not necessary.
- The screwdriver locks onto terminal freeing up hands.

Better project identification

- Circuit identification is improved thanks to the 20% larger marking area
- Pre-mark by hand or with label on our flat marking surface and start immediately the wiring, before the final markers mounting
- Spare markers re-printing in case of modifications.

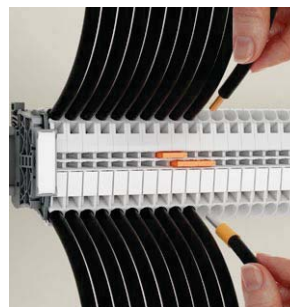

Push-in mode



Spring mode

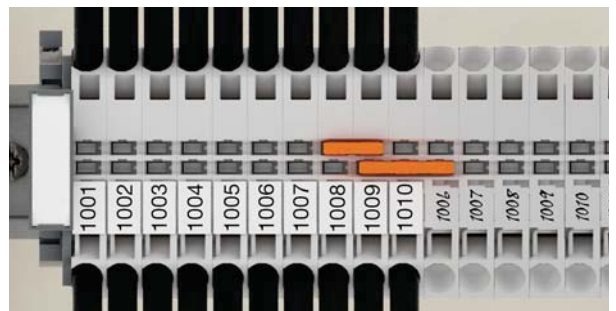

Clear circuit identification

1SNK162074S0201

PI-Spring technology - SNK series, terminal blocks

Features and benefits

Easy to install

Smart design facilitating assembly process

Mounting, wiring, testing... made easy

Avoid mounting and wiring errors: asymmetrical design allows immediate visual check in case of reversed terminal blocks.



Asymmetrical design avoids mounting error

Faster accessories mounting

Save up to 70% mounting time thanks to :

- screwless jumpers, component plugs, test devices, end stops and snap-in ground terminal blocks.

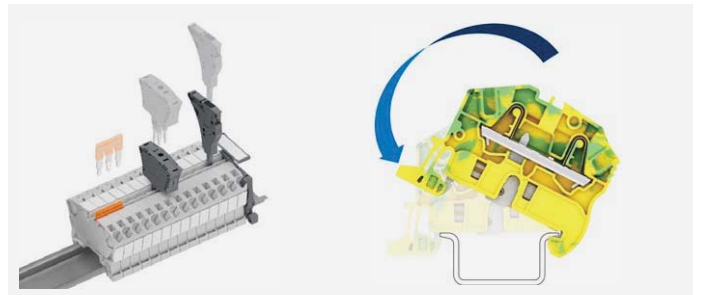

Screwless accessories

Snap-in ground terminal blocks

Closed jumper location allows great stiffness of the terminal block, avoid deflection while tightening and optimal jumper guiding.

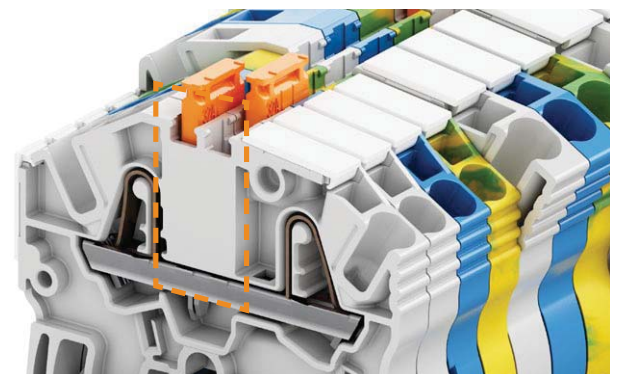

Closed jumper location for stiffness.

PI-Spring technology - SNK series, terminal blocks

Features and benefits

Easy to install

Smart accessories

Flexible test solutions from individual insulated test adapter to test connectors for complete assemblies testing.

- Direct plug-in into jumpers channels
- 5, 6, 8 mm spacing, mixing various spacing is possible
- 1000 V rating.



Plug-in individual test adapter.

Plug-in test connector.

Component holder plugs for series or parallel component mounting (resistors, filters, diodes..).

Can be installed after wiring.

Series plug offers screwless component connection (no soldering).

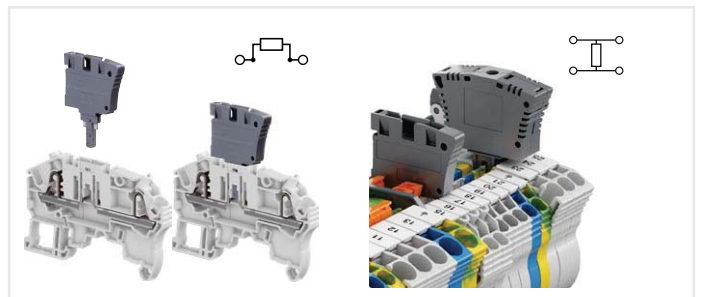

Series plug associated with disconnect blocks.

Parallel plug to be installed between 2 blocks.

Smart plug-in jumpers:

Pre-cut poles removable by hand: clean cut.

Insulated up to 1000 V (avoid use of separators).

Predefined shapes in molding to easily identify connected poles with a pen.

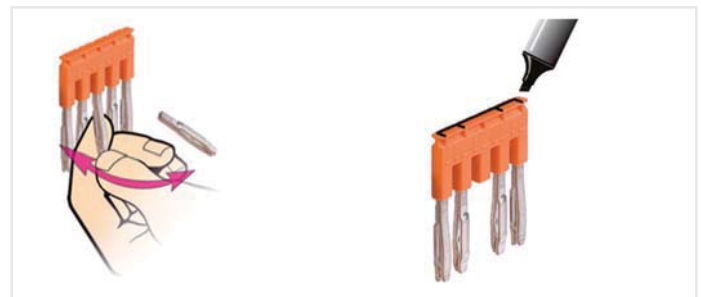

Pre-cut poles easy removable by hand.

Predefined shape to identify connected poles.

PI-Spring technology - SNK series, terminal blocks

Features and benefits

Optimized logistics

Reduce your accessories inventory by up to 50%

SNK PI-Spring, screw and pluggable ranges share the same accessories.

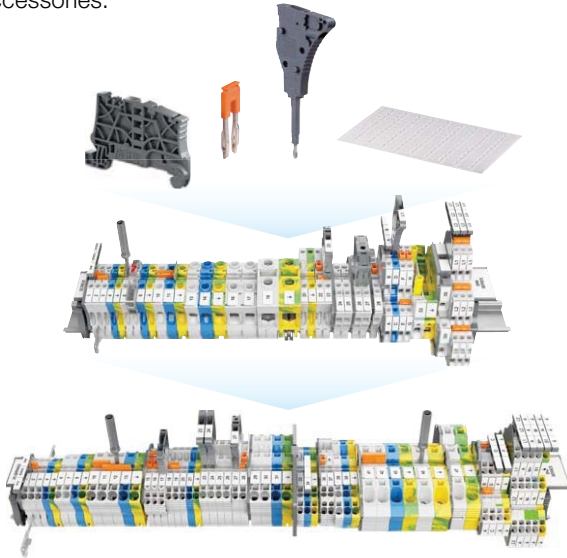

Shared accessories for SNK PI-Spring, screw and pluggable ranges

- All end sections and circuit separators fit several types and sizes of blocks
- One end section fits up to 21 models
- One circuit separator fits with 62 terminal blocks.



End sections and circuit separators fit several types and sizes of blocks

50% less inventory makes PI-Spring attractive to all worldwide markets

- The user selects one range but benefit from 2 connection modes (push-in and spring) which have global certifications and access to markets and applications worldwide
- Reduced packaging adapted to the usage (20 items packaging on some items).



Push-in range + Spring range

PI-Spring

Facilitate maintenance operations

Terminal blocks can be individually removed from a terminal assembly equipped with markers: TE Connectivity markers become independent after strip mounting. The markers remain on terminal in any situation.

Markers are interchangeable: the smaller marker can fit any bigger block.

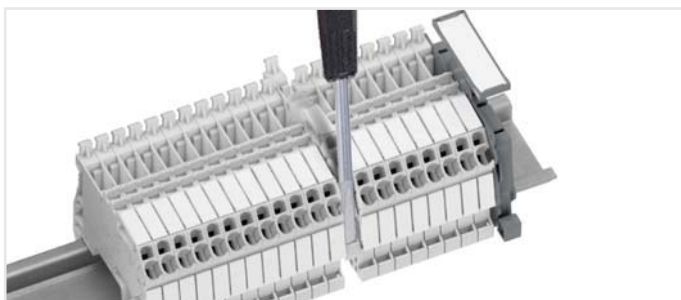

Maintenance operations facilitated

Reliable in harsh conditions

Qualified for worldwide markets, applications and for severe environments: vibration, shock, corrosion...

High corrosion resistance

PI-Spring clamp is made of high quality stainless steel. Salt mist withstand up to 1,000 hours (as per IEC 60068).

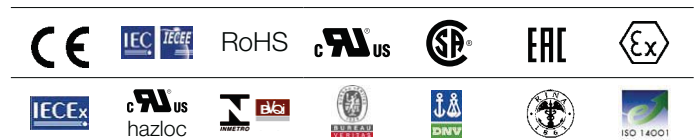

SNK series, terminal blocks

PI-Spring technology - Range overview from 2.5 to 16 mm² - 12 to 4 AWG

2 Connections

Single deck

Feed-through
Ground
Disconnect
Fuse
Solar : 1500 VDC

NEW

3 Connections

Single deck

Feed-through
Ground
Solar: 1500 VDC

NEW

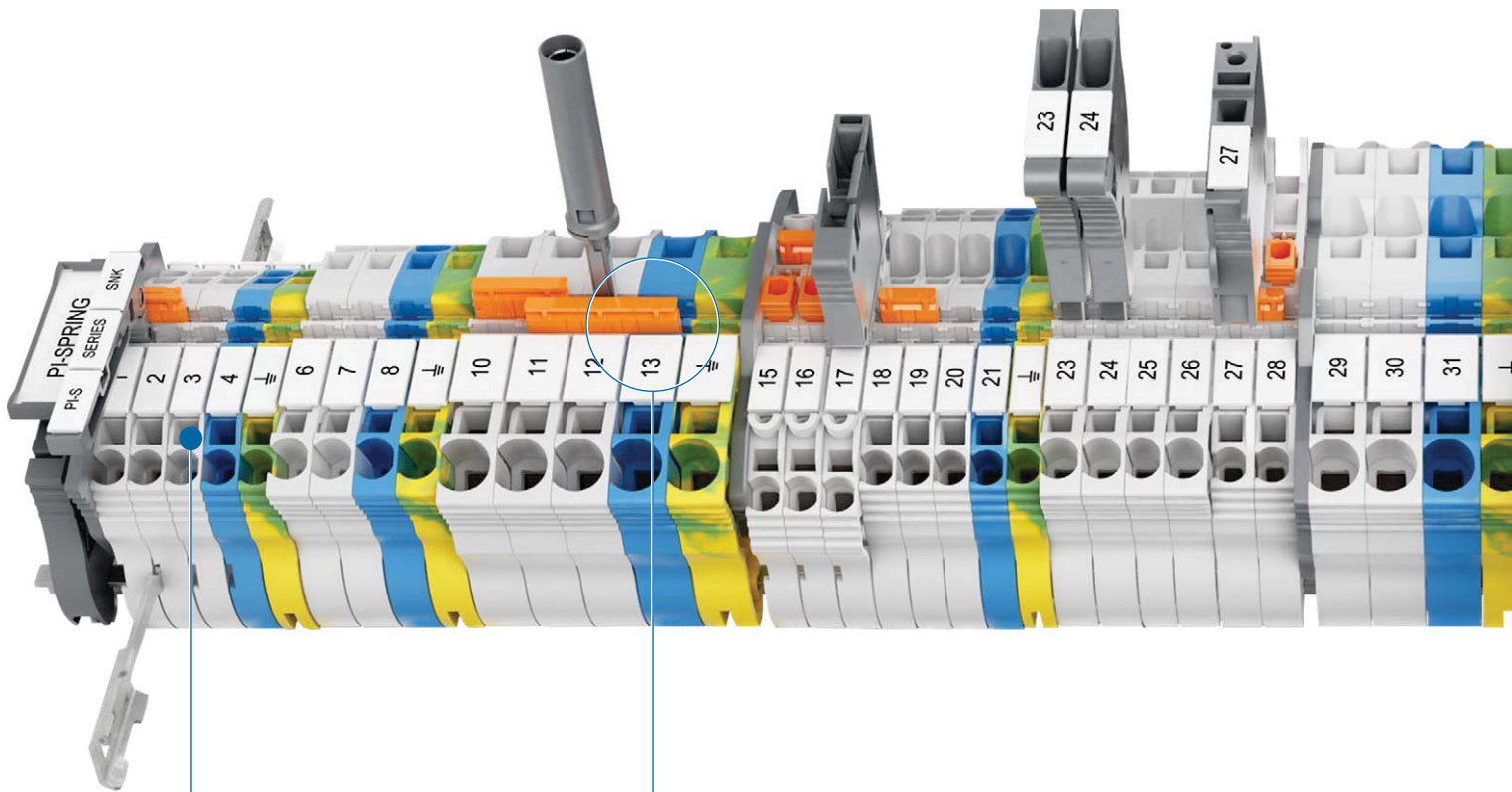

Voltage test

screwdriver entry
point accepts
Category II probes

Double central channels

allows multiconfigurations
(jumping, testing and measuring)

4

Connections



Single deck

Feed-through
Ground
Disconnect
Component holder

2x2

Connections



Double deck

Feed-through
Ground
Component holder

3x2

Connections



Triple deck

Feed-through
Ground

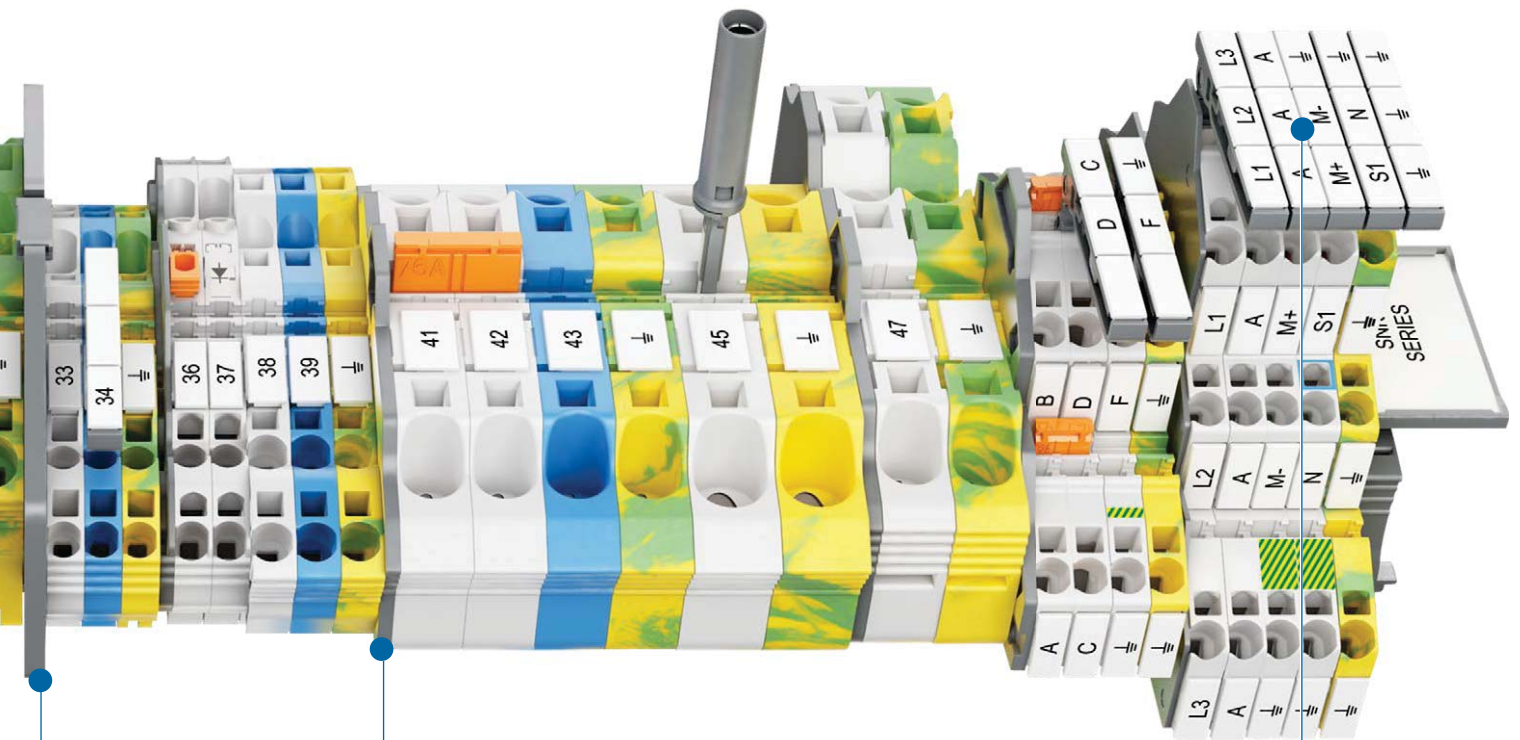

Two circuit separators
for the entire range

End section
can be used
as circuit separator

Rotating label holder
easy plug-in in
jumper channel

SNK series, terminal blocks

PI-Spring technology

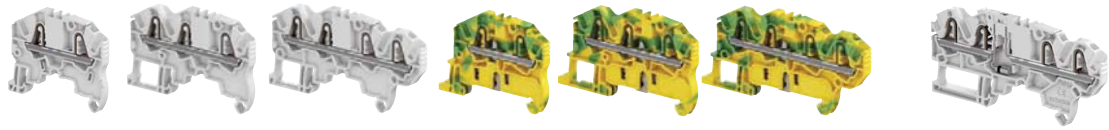

		Feed-through			Ground			Component holder	
Section									
2.5 mm ²	12 AWG	ZK2.5	ZK2.5-3P	ZK2.5-4P	ZK2.5-PE	ZK2.5-PE-3P	ZK2.5-PE 4P	ZK2.5-CH-4P-LR	ZK2.5-CH-4P-RL
4 mm ²	10 AWG	ZK4	ZK4-3P	ZK4-4P	ZK4-PE	ZK4-PE-3P	ZK4-PE- 4P		
6 mm ²	8 AWG	ZK6	ZK6-3P		ZK6-PE	ZK6-PE-3P			
10 mm ²	6 AWG	ZK10	ZK10-3P		ZK10-PE	ZK10-PE-3P			
16 mm ²	4 AWG	ZK10-PV New	ZK10-3P-PV						
		ZK16	ZK16-3P	ZK16-PE	ZK16-PE-3P				
		ZK16-PV New	ZK16-3P-PV						

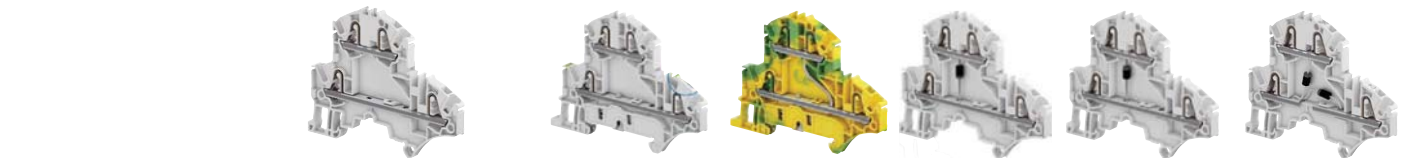

Double deck		Feed-through		Ground		Component holder			
Section									
2.5 mm ²	12 AWG	ZK2.5-D2	ZK2.5-D1	ZK2.5-D2-PE	ZK2.5-D1-PE	ZK2.5-D-CH-UD	ZK2.5-D-CH-DU	ZK2.5-D-CH2-DU-RL	



Triple deck		Feed-through		Ground	
Section					
2.5 mm ²	12 AWG	ZK2.5-T3	ZK2.5-T1	ZK2.5-L-L-PE	ZK2.5-T1-PE
				ZK2.5-L-N-PE	



Disconnect		With blade		With plug		For 5x20 mm fuses		Aligned with ZK2.5-SF
Section								
2.5 mm ²	12 AWG	ZK2.5-S	ZK2.5-S-4P	ZK2.5-SP	ZK2.5-SP-4P	ZK2.5-SF	ZK2.5-SF-R1	ZK2.5-S-R1
						ZK2.5-SF-R3		

Clamp -
 Channels for jumpering or testing -
 Test socket -
 Blown-fuse indicator

1SNK162020S0201 - Rev. B

ZK2.5 PI-Spring terminal blocks

Feed-through - 5.2 mm 0.205 in spacing



ZK2.5

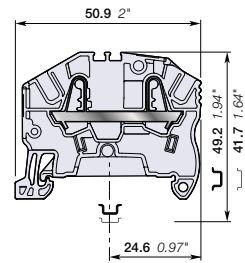

5.2 mm 0.205 in spacing

Description

Combine high performance with compact dimensions:

- 1000 V AC / DC IEC 600 V UL,
- Opt for the best marking visibility thanks to the up-front, flat marker zone, which lets you mark up to eight digits or increase the font size.

Ordering details

Description	Color	Type	Part Number	Pkg qty	Weight (1 pce) g
Feed-through 2 connections	Grey	ZK2.5	1SNK705010R0000	50	5.50
	Blue	ZK2.5-BL	1SNK705020R0000	50	5.50
	Orange	ZK2.5-OR	1SNK705030R0000	50	5.50
	Yellow	ZK2.5-YL	1SNK705060R0000	50	5.50
	Green	ZK2.5-GN	1SNK705061R0000	50	5.50
	Red	ZK2.5-RD	1SNK705062R0000	50	5.50
	White	ZK2.5-WH	1SNK705065R0000	50	5.50
	Black	ZK2.5-BK	1SNK705066R0000	50	5.50

Main technical data

Connecting capacity	IEC	UL - CSA	Rail	Wire stripping length	TH 35-7.5, TH 35-15
1 conductor per clamp	Rigid: Solid/Stranded	0.2 ... 4 mm²	26 ... 12 AWG	11 mm	0.433 in
	Flexible without ferrule	0.22 ... 2.5 mm²	26 ... 14 AWG		
	Flexible with non insulated ferrule	0.22 ... 2.5 mm²	26 ... 14 AWG		
	Flexible with insulated ferrule	0.22 ... 2.5 mm²	26 ... 14 AWG		
2 conductors per clamp	Flexible with twin ferrule	0.22 ... 0.5 mm²	26 ... 20 AWG	Tool (for flexible conductor without ferrule)	Flat screwdriver Ø 3.5 mm Ø 0.138 in
Rated current / Rated cross section		24 A / 2.5 mm²	20 A / 12 AWG		
Rated short-time withstand current (1s)		300 A	396 A		
Short Circuit Current Rating (with specific conditions)			100 kA		
Rated voltage		1000 V	600 V		
Impulse withstand voltage		8000 V			
Protection		IP20	NEMA 1		

Increased safety Ex e 693 V 21 A IEC/EN 60079-7 - IM2 II 2 GD Ex eb I/II/III/C
 The connecting capacity data for one Rigid: Solid/Stranded, or one Flexible conductor (when applicable) is a mandatory information required by IEC, UL and CSA standards (Copper conductors). All other data are provided as supplementary information only. For more details, please consult our CB, UL or CSA certificates and technical datasheet available on <http://www.TE.com>



Accessories

Description	Color	Type	Part Number	Pkg qty	Weight (1 pce) g	
1 End stops	Dark grey	BAZ1	1SNK900002R0000	50	5.30	
2 End sections	Dark grey	EK2.5	1SNK705910R0000	20	1.80	
3 Jumper bars	Orange	2 poles	JB5-2	1SNK905302R0000	50	1.30
		3 poles	JB5-3	1SNK905303R0000	50	2.00
		4 poles	JB5-4	1SNK905304R0000	50	2.70
		5 poles	JB5-5	1SNK905305R0000	50	3.50
		10 poles	JB5-10	1SNK905310R0000	30	7.10
		50 poles	JB5-50	1SNK905350R0000	10	36.00
4 Cross spacing jumpers	Orange	JB85-3	1SNK900603R0000	10	2.80	
5 Circuit separators	Dark grey	CS-R2	1SNK900106R0000	20	3.80	
6 Test adapters	Dark grey	For test plugs DIA 2 mm 0.079 in	TP2	1SNK900203R0000	20	1.70
		For test plugs DIA 4 mm 0.157 in	TP4	1SNK900205R0000	20	2.40
7 Test connectors	Dark grey	5.2 mm 0.205 in spacing	TC5	1SNK900200R0000	10	5.20
		End module, 5.2 mm 0.205 in	TC5-R1	1SNK900201R0000	10	5.20
8 Shield connectors		SHBP	1SNK900601R0000	20	4.10	
9 Terminal block markers	White	Blank marker	MG-CPM 13 41790	1SNB041790R0512	1960	0.23
		Blank card	MC512	1SNK140000R0000	22	9.00
			MC512PA	1SNK149999R0000	20	10.00
		Universal wire markers holder	Grey	UMH	1SNK900611R0000	10

Complete list of accessories is indicated in the terminal block datasheet including end stops. Some accessories such as jumper bars may modify the terminal block's ratings: Complete information available in the accessories section of the catalog.

Ground PI-Spring terminal blocks

Description	Color	Type	Part Number	Pkg qty	Weight (1 pce) g
Ground	Green-yellow	ZK2.5-PE	1SNK705150R0000	20	10.00



Technical data valid for copper conductors only.

ZK2.5-3P PI-Spring terminal blocks

Feed-through with 3 connections - 5.2 mm 0.205 in spacing



ZK2.5-3P

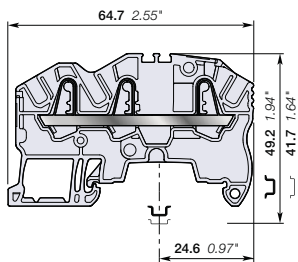

5.2 mm 0.205 in spacing

Description

Find all the features of the ZK2.5 terminal block with the added option of distributing or branching 3 conductors.

Ordering details

Description	Color	Type	Part Number	Pkg qty	Weight (1 pce) g
Feed-through 3 connections	Grey	ZK2.5-3P	1SNK705011R0000	50	7.40
	Blue	ZK2.5-3P-BL	1SNK705021R0000	50	7.40
	Orange	ZK2.5-3P-OR	1SNK705031R0000	50	7.40
	Yellow	ZK2.5-3P-YL	1SNK705067R0000	50	7.40
	Green	ZK2.5-3P-GN	1SNK705068R0000	50	7.40
	Red	ZK2.5-3P-RD	1SNK705069R0000	50	7.40
	White	ZK2.5-3P-WH	1SNK705072R0000	50	7.40
	Black	ZK2.5-3P-BK	1SNK705073R0000	50	7.40

Main technical data

Connecting capacity	IEC	UL - CSA	Rail	Wire stripping length	TH 35-7.5, TH 35-15
1 conductor per clamp	Rigid: Solid/Stranded	0.2 ... 4 mm ²	26 ... 12 AWG	11 mm	0.433 in
	Flexible without ferrule	0.22 ... 2.5 mm ²			
	Flexible with non insulated ferrule	0.22 ... 2.5 mm ²	26 ... 14 AWG		
	Flexible with insulated ferrule	0.22 ... 2.5 mm ²	26 ... 14 AWG		
2 conductors per clamp	Flexible with twin ferrule	0.22 ... 0.5 mm ²	26 ... 20 AWG	Tool (for flexible conductor without ferrule)	Flat screwdriver Ø 3.5 mm Ø 0.138 in
Rated current / Rated cross section		24 A / 2.5 mm ²	20 A / 12 AWG		
Rated short-time withstand current (1s)		300 A	396 A		
Short Circuit Current Rating (with specific conditions)			100 kA		
Rated voltage		1000 V	600 V		
Impulse withstand voltage		8000 V			
Protection		IP20	NEMA 1		
Increased safety Ex e		693 V 21 A IEC/EN 60079-7 - IM2 II 2 GD Ex eb IIC/IIC			

The connecting capacity data for one Rigid: Solid/Stranded, or one Flexible conductor (when applicable) is a mandatory information required by IEC, UL and CSA standards (Copper conductors). All other data are provided as supplementary information only. For more details, please consult our CB, UL or CSA certificates and technical datasheet available on <http://www.TE.com>



Accessories

Description	Color	Type	Part Number	Pkg qty	Weight (1 pce) g	
1 End stops	Dark grey	BAZ1	1SNK900002R0000	50	5.30	
2 End sections	Dark grey	EK2.5-3P	1SNK705911R0000	20	2.40	
3 Jumper bars	Orange	2 poles	JB5-2	1SNK905302R0000	50	1.30
		3 poles	JB5-3	1SNK905303R0000	50	2.00
		4 poles	JB5-4	1SNK905304R0000	50	2.70
		5 poles	JB5-5	1SNK905305R0000	50	3.50
		10 poles	JB5-10	1SNK905310R0000	30	7.10
4 Cross spacing jumpers	Orange	JB85-3	1SNK900603R0000	10	2.80	
5 Circuit separators	Dark grey	CS-R3	1SNK900107R0000	20	6.40	
6 Test adapters	Dark grey	For test plugs DIA 2 mm 0.079 in	TP2	1SNK900203R0000	20	1.70
		For test plugs DIA 4 mm 0.157 in	TP4	1SNK900205R0000	20	2.40
7 Test connectors	Dark grey	5.2 mm 0.205 in spacing	TC5	1SNK900200R0000	10	5.20
		End module, 5.2 mm 0.205 in	TC5-R1	1SNK900201R0000	10	5.20
		Blank marker	White	MG-CPM 13 41790	1SNB041790R0512	1960
8 Terminal block markers	White	Blank card	MC512	1SNK140000R0000	22	9.00
			MC512PA	1SNK149999R0000	20	10.00
		Universal wire markers holder	Grey	UMH	1SNK900611R0000	10

Complete list of accessories is indicated in the terminal block datasheet including end stops. Some accessories such as jumper bars may modify the terminal block's ratings: Complete information available in the accessories section of the catalog.

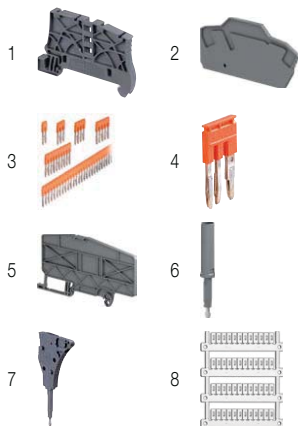

Ground PI-Spring terminal blocks

Description	Color	Type	Part Number	Pkg qty	Weight (1 pce) g
Ground	Green-yellow	ZK2.5-PE-3P	1SNK705151R0000	20	11.90

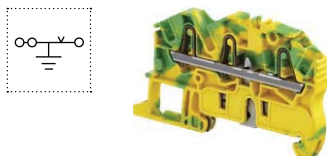

Technical data valid for copper conductors only.

ZK2.5-4P PI-Spring terminal blocks

Feed-through with 4 connections - 5.2 mm 0.205 in spacing



ZK2.5-4P

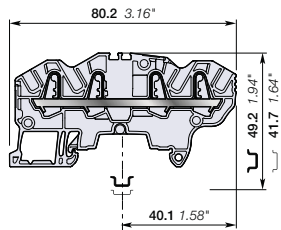

5.2 mm 0.205 in spacing

Description

Find all the features of the ZK2.5 terminal block with the added option of distributing or branching 4 conductors.

Ordering details

Description	Color	Type	Part Number	Pkg qty	Weight (1 pce) g
Feed-through 4 connections	Grey	ZK2.5-4P	1SNK705012R0000	50	9.00
	Blue	ZK2.5-4P-BL	1SNK705022R0000	50	9.00
	Orange	ZK2.5-4P-OR	1SNK705032R0000	50	9.00
	Yellow	ZK2.5-4P-YL	1SNK705074R0000	50	9.00
	Green	ZK2.5-4P-GN	1SNK705075R0000	50	9.00
	Red	ZK2.5-4P-RD	1SNK705076R0000	50	9.00
	White	ZK2.5-4P-WH	1SNK705079R0000	50	9.00
	Black	ZK2.5-4P-BK	1SNK705080R0000	50	9.00

Main technical data

Connecting capacity	IEC	UL - CSA	Mounting instructions
1 conductor per clamp	Rigid: Solid/Stranded	0.2 ... 4 mm ²	26 ... 12 AWG
	Flexible without ferrule	0.22 ... 2.5 mm ²	26 ... 14 AWG
	Flexible with non insulated ferrule	0.22 ... 2.5 mm ²	26 ... 14 AWG
	Flexible with insulated ferrule	0.22 ... 2.5 mm ²	26 ... 14 AWG
2 conductors per clamp	Flexible with twin ferrule	0.22 ... 0.5 mm ²	26 ... 20 AWG
Rated current / Rated cross section		24 A / 2.5 mm ²	20 A / 12 AWG
Rated short-time withstand current (1s)		300 A	396 A
Short Circuit Current Rating (with specific conditions)			100 kA
Rated voltage		1000 V	600 V
Impulse withstand voltage		8000 V	
Protection		IP20	NEMA 1
Increased safety Ex e		693 V 21 A IEC/EN 60079-7 - IM2 II 2 GD Ex eb I/IC/IIIC	

The connecting capacity data for one Rigid: Solid/Stranded, or one Flexible conductor (when applicable) is a mandatory information required by IEC, UL and CSA standards (Copper conductors). All other data are provided as supplementary information only. For more details, please consult our CB, UL or CSA certificates and technical datasheet available on <http://www.TE.com>

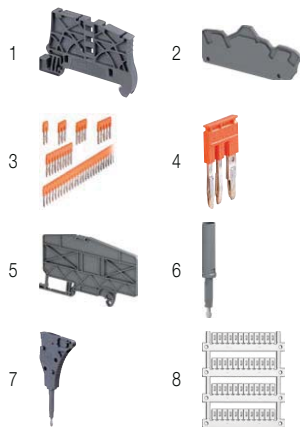

Accessories

Description	Color	Type	Part Number	Pkg qty	Weight (1 pce) g	
1 End stops	Dark grey	BAZ1	1SNK900002R0000	50	5.30	
2 End sections	Dark grey	EK2.5-4P	1SNK705912R0000	20	2.70	
3 Jumper bars	Orange	2 poles	JB5-2	1SNK905302R0000	50	1.30
		3 poles	JB5-3	1SNK905303R0000	50	2.00
		4 poles	JB5-4	1SNK905304R0000	50	2.70
		5 poles	JB5-5	1SNK905305R0000	50	3.50
		10 poles	JB5-10	1SNK905310R0000	30	7.10
		50 poles	JB5-50	1SNK905350R0000	10	36.00
4 Cross spacing jumpers	Orange	JB85-3	1SNK900603R0000	10	2.80	
5 Circuit separators	Dark grey	CS-R3	1SNK900107R0000	20	6.40	
6 Test adapters	Dark grey	For test plugs DIA 2 mm 0.079 in	TP2	1SNK900203R0000	20	1.70
		For test plugs DIA 4 mm 0.157 in	TP4	1SNK900205R0000	20	2.40
7 Test connectors	Dark grey	5.2 mm 0.205 in spacing	TC5	1SNK900200R0000	10	5.20
		End module, 5.2 mm 0.205 in	TC5-R1	1SNK900201R0000	10	5.20
8 Terminal block markers	White	Blank marker	MG-CPM 13 41790	1SNB041790R0512	1960	0.23
		Blank card	MC512	1SNK140000R0000	22	9.00
			MC512PA	1SNK149999R0000	20	10.00
	Universal wire markers holder	Grey	UMH	1SNK900611R0000	10	0.20

Complete list of accessories is indicated in the terminal block datasheet including end stops. Some accessories such as jumper bars may modify the terminal block's ratings: Complete information available in the accessories section of the catalog.



Ground PI-Spring terminal blocks

Description	Color	Type	Part Number	Pkg qty	Weight (1 pce) g
Ground	Green-yellow	ZK2.5-PE-4P	1SNK705152R0000	20	13.60

Technical data valid for copper conductors only.

ZK4 PI-Spring terminal blocks

Feed-through - 6 mm 0.236 in spacing



ZK4

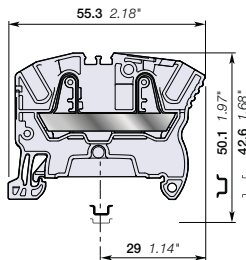

6 mm 0.236 in spacing

Description

Combine high performance with compact dimensions:

- 1000 V AC / DC IEC 600 V UL,
- Opt for the best marking visibility thanks to the up-front, flat marker zone, which lets you mark up to eight digits or increase the font size.

Ordering details

Description	Color	Type	Part Number	Pkg qty	Weight (1 pce) g
Feed-through 2 connections	Grey	ZK4	1SNK706010R0000	50	7.90
	Blue	ZK4-BL	1SNK706020R0000	50	7.90
	Orange	ZK4-OR	1SNK706030R0000	50	7.90
	Yellow	ZK4-YL	1SNK706060R0000	50	7.90
	Red	ZK4-RD	1SNK706062R0000	50	7.90
	Black	ZK4-BK	1SNK706066R0000	50	7.90

Main technical data

Connecting capacity		IEC	UL - CSA	Mounting instructions	
1 conductor per clamp	Rigid: Solid/Stranded	0.5 ... 6 mm ²	26 ... 10 AWG	Rail	TH 35-7.5, TH 35-15
	Flexible without ferrule	0.5 ... 4 mm ²		Wire stripping length	12.5 mm 0.492 in
	Flexible with non insulated ferrule	0.5 ... 4 mm ²	26 ... 12 AWG	Tool (for flexible conductor without ferrule)	Flat screwdriver Ø 3.5 mm Ø 0.138 in
	Flexible with insulated ferrule	0.5 ... 4 mm ²	26 ... 12 AWG		
2 conductors per clamp	Flexible with twin ferrule	0.5 ... 1 mm ²	26 ... 18 AWG		
Rated current / Rated cross section		32 A / 4 mm ²	30 A / 10 AWG		
Rated short-time withstand current (1s)		480 A	636 A		
Short Circuit Current Rating (with specific conditions)			100 kA		
Rated voltage		1000 V	600 V		
Impulse withstand voltage		8000 V			
Protection		IP20	NEMA 1		
Increased safety Ex e		693 V 29 A IEC/EN 60079-7 - IM2 II 2 GD Ex eb IIC/IIC			

The connecting capacity data for one Rigid: Solid/Stranded, or one Flexible conductor (when applicable) is a mandatory information required by IEC, UL and CSA standards (Copper conductors). All other data are provided as supplementary information only. For more details, please consult our CB, UL or CSA certificates and technical datasheet available on <http://www.TE.com>



Accessories

Description	Color	Type	Part Number	Pkg qty	Weight (1 pce) g	
1 End stops	Dark grey	BAZ1	1SNK900002R0000	50	5.30	
2 End sections	Dark grey	EK2.5	1SNK705910R0000	20	1.80	
3 Jumper bars	Orange	2 poles	JB6-2	1SNK906302R0000	50	1.30
		3 poles	JB6-3	1SNK906303R0000	50	2.10
		4 poles	JB6-4	1SNK906304R0000	50	2.90
		5 poles	JB6-5	1SNK906305R0000	50	3.60
		10 poles	JB6-10	1SNK906310R0000	20	7.40
		50 poles	JB6-50	1SNK906350R0000	10	38.10
4 Cross spacing jumpers	Orange	JB85-3	1SNK900603R0000	10	2.80	
5 Circuit separators	Dark grey	CS-R2	1SNK900106R0000	20	3.80	
6 Test adapters	Dark grey	For test plugs DIA 2 mm 0.079 in	TP2	1SNK900203R0000	20	1.70
		For test plugs DIA 4 mm 0.157 in	TP4	1SNK900205R0000	20	2.40
7 Test connectors	Dark grey	TC5-R1	1SNK900201R0000	10	5.20	
8 Spacers	Dark grey	ES-TC6	1SNK900105R0000	10	0.80	
9 Terminal block markers	White	Blank marker	MG-CPM 13 41791	1SNB041791R0612	1680	0.27
		Blank card	MC612	1SNK150000R0000	22	10.00
			MC612PA	1SNK159999R0000	20	11.00
		Universal wire markers holder	Grey	UMH	1SNK900611R0000	10

Complete list of accessories is indicated in the terminal block datasheet including end stops. Some accessories such as jumper bars may modify the terminal block's ratings: Complete information available in the accessories section of the catalog.

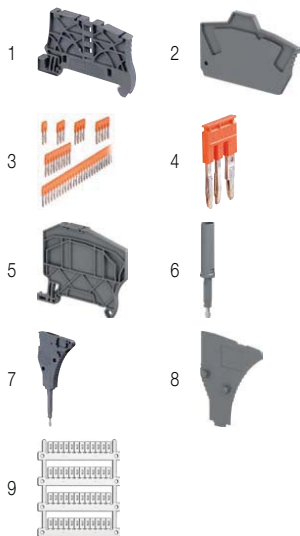

Ground PI-Spring terminal blocks

Description	Color	Type	Part Number	Pkg qty	Weight (1 pce) g
Ground Profile aligned with ZK4	Green-yellow	ZK4-PE	1SNK706150R0000	20	12.60

Technical data valid for copper conductors only.

ZK4-3P PI-Spring terminal blocks

Feed-through with 3 connections - 6 mm 0.236 in spacing



ZK4-3P

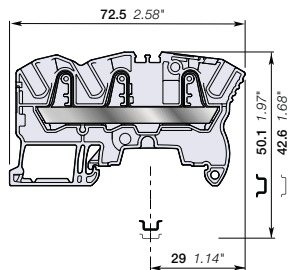

6 mm 0.236 in spacing

Description

Find all the features of the ZK4 terminal block with the added option of distributing or branching 3 conductors.

Ordering details

Description	Color	Type	Part Number	Pkg qty	Weight (1 pce) g
Feed-through 3 connections	Grey	ZK4-3P	1SNK706011R0000	50	11.00
	Blue	ZK4-3P-BL	1SNK706021R0000	50	11.00
	Orange	ZK4-3P-OR	1SNK706031R0000	50	11.00

Main technical data

Connecting capacity	IEC	UL - CSA	Rail	Wire stripping length	TH 35-7.5, TH 35-15
1 conductor per clamp	Rigid: Solid/Stranded	0.5 ... 6 mm²	26 ... 10 AWG	Tool (for flexible conductor without ferrule)	Flat screwdriver Ø 3.5 mm Ø 0.138 in
	Flexible without ferrule	0.5 ... 4 mm²			
	Flexible with non insulated ferrule	0.5 ... 4 mm²	26 ... 12 AWG		
	Flexible with insulated ferrule	0.5 ... 4 mm²	26 ... 12 AWG		
2 conductors per clamp	Flexible with twin ferrule	0.5 ... 1 mm²	26 ... 18 AWG		
Rated current / Rated cross section		32 A / 4 mm²	30 A / 10 AWG		
Rated short-time withstand current (1s)		480 A	636 A		
Short Circuit Current Rating (with specific conditions)			100 kA		
Rated voltage		1000 V	600 V		
Impulse withstand voltage		8000 V			
Protection		IP20	NEMA 1		
Increased safety Ex e		693 V 29 A IEC/EN 60079-7 - IM2 II 2 GD Ex eb I/IIc/IIIC			

The connecting capacity data for one Rigid: Solid/Stranded, or one Flexible conductor (when applicable) is a mandatory information required by IEC, UL and CSA standards (Copper conductors). All other data are provided as supplementary information only. For more details, please consult our CB, UL or CSA certificates and technical datasheet available on <http://www.TE.com>



Accessories

Description	Color	Type	Part Number	Pkg qty	Weight (1 pce) g	
1 End stops	Dark grey	BAZ1	1SNK900002R0000	50	5.30	
2 End sections	Dark grey	EK2.5-3P	1SNK705911R0000	20	2.40	
3 Jumper bars	Orange	2 poles	JB6-2	1SNK906302R0000	50	1.30
		3 poles	JB6-3	1SNK906303R0000	50	2.10
		4 poles	JB6-4	1SNK906304R0000	50	2.90
		5 poles	JB6-5	1SNK906305R0000	50	3.60
		10 poles	JB6-10	1SNK906310R0000	20	7.40
		50 poles	JB6-50	1SNK906350R0000	10	38.10
4 Cross spacing jumpers	Orange	JB85-3	1SNK900603R0000	10	2.80	
5 Circuit separators	Dark grey	3 mm	CS-R3	1SNK900107R0000	20	6.40
		0.118 in				
6 Test adapters	Dark grey	For test plugs DIA 2 mm 0.079 in	TP2	1SNK900203R0000	20	1.70
		For test plugs DIA 4 mm 0.157 in	TP4	1SNK900205R0000	20	2.40
7 Test connectors	Dark grey	TC5-R1	1SNK900201R0000	10	5.20	
8 Spacers	Dark grey	0.8 mm	ES-TC6	1SNK900105R0000	10	0.80
		0.031 in				
9 Terminal block markers	White	Blank marker	MG-CPM 13 41791	1SNB041791R0612	1680	0.27
		Blank card	MC612	1SNK150000R0000	22	10.00
			MC612PA	1SNK159999R0000	20	11.00
	Universal wire markers holder	Grey	UMH	1SNK900611R0000	10	0.20

Complete list of accessories is indicated in the terminal block datasheet including end stops. Some accessories such as jumper bars may modify the terminal block's ratings: Complete information available in the accessories section of the catalog.



Ground PI-Spring terminal blocks

Description	Color	Type	Part Number	Pkg qty	Weight (1 pce) g
Ground	Green-yellow	ZK4-PE-3P	1SNK706151R0000	20	15.70

Technical data valid for copper conductors only.



ZK4-4P PI-Spring terminal blocks

Feed-through with 4 connections - 6 mm 0.236 in spacing



ZK4-4P

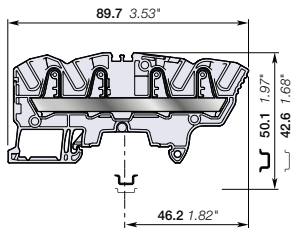

6 mm 0.236 in spacing

Description

Find all the features of the ZK4 terminal block with the added option of distributing or branching 4 conductors.

Ordering details

Description	Color	Type	Part Number	Pkg qty	Weight (1 pce) g
Feed-through 4 connections	Grey	ZK4-4P	1SNK706012R0000	50	13.80
	Blue	ZK4-4P-BL	1SNK706022R0000	50	13.80
	Orange	ZK4-4P-OR	1SNK706032R0000	50	13.80

Main technical data

Connecting capacity		IEC	UL - CSA	Mounting instructions	
1 conductor per clamp	Rigid: Solid/Stranded	0.5 ... 6 mm ²	26 ... 10 AWG	Rail	TH 35-7.5, TH 35-15
	Flexible without ferrule	0.5 ... 4 mm ²		Wire stripping length	12.5 mm 0.492 in
	Flexible with non insulated ferrule	0.5 ... 4 mm ²	26 ... 12 AWG		
	Flexible with insulated ferrule	0.5 ... 4 mm ²	26 ... 12 AWG		
2 conductors per clamp	Flexible with twin ferrule	0.5 ... 1 mm ²	26 ... 18 AWG	Tool (for flexible conductor without ferrule)	Flat screwdriver Ø 3.5 mm Ø 0.138 in
Rated current / Rated cross section		32 A / 4 mm ²	30 A / 10 AWG		
Rated short-time withstand current (1s)		480 A	636 A		
Short Circuit Current Rating (with specific conditions)			100 kA		
Rated voltage		1000 V	600 V		
Impulse withstand voltage		8000 V			
Protection		IP20	NEMA 1		
Increased safety Ex e		693 V 29 A IEC/EN 60079-7 - IM2 II 2 GD Ex eb I/IC/IIIC			

The connecting capacity data for one Rigid: Solid/Stranded, or one Flexible conductor (when applicable) is a mandatory information required by IEC, UL and CSA standards (Copper conductors). All other data are provided as supplementary information only. For more details, please consult our CB, UL or CSA certificates and technical datasheet available on <http://www.TE.com>



Accessories

Description	Color	Type	Part Number	Pkg qty	Weight (1 pce) g	
1 End stops	Dark grey	BAZ1	1SNK900002R0000	50	5.30	
2 End sections	Dark grey	EK2.5-4P	1SNK705912R0000	20	2.70	
3 Jumper bars	Orange	2 poles	JB6-2	1SNK906302R0000	50	1.30
		3 poles	JB6-3	1SNK906303R0000	50	2.10
		4 poles	JB6-4	1SNK906304R0000	50	2.90
		5 poles	JB6-5	1SNK906305R0000	50	3.60
		10 poles	JB6-10	1SNK906310R0000	20	7.40
		50 poles	JB6-50	1SNK906350R0000	10	38.10
4 Cross spacing jumpers	Orange	JB85-3	1SNK900603R0000	10	2.80	
5 Circuit separators	Dark grey	CS-R3	1SNK900107R0000	20	6.40	
6 Test adapters	Dark grey	For test plugs DIA 2 mm 0.079 in	TP2	1SNK900203R0000	20	1.70
		For test plugs DIA 4 mm 0.157 in	TP4	1SNK900205R0000	20	2.40
7 Test connectors	Dark grey	TC5-R1	1SNK900201R0000	10	5.20	
8 Spacers	Dark grey	ES-TC6	1SNK900105R0000	10	0.80	
9 Terminal block markers	White	MG-CPM 13 41791	1SNB041791R0612	1680	0.27	
		MC612	1SNK150000R0000	22	10.00	
		MC612PA	1SNK159999R0000	20	11.00	
	Grey	UMH	1SNK900611R0000	10	0.20	

Complete list of accessories is indicated in the terminal block datasheet including end stops. Some accessories such as jumper bars may modify the terminal block's ratings: Complete information available in the accessories section of the catalog.

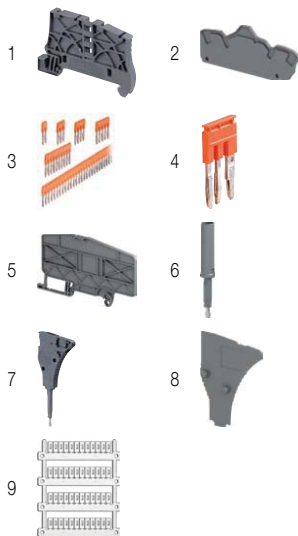

Ground PI-Spring terminal blocks

Description	Color	Type	Part Number	Pkg qty	Weight (1 pce) g
Ground Profile aligned with ZK4-4P	Green-yellow	ZK4-PE-4P	1SNK706152R0000	20	18.40

Technical data valid for copper conductors only.

ZK6 PI-Spring terminal blocks

Feed-through - 8 mm 0.315 in spacing

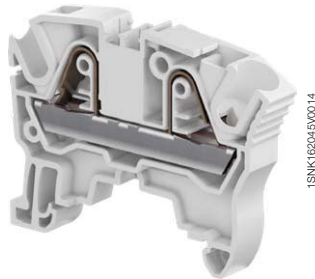

ZK6

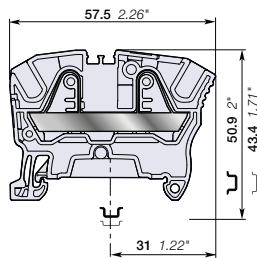

8 mm 0.315 in spacing

Description

Combine high performance with compact dimensions:

- 1000 V AC / DC IEC 600 V UL,
- Opt for the best marking visibility thanks to the up-front, flat marker zone, which lets you mark up to eight digits or increase the font size.

Ordering details

Description	Color	Type	Part Number	Pkg qty	Weight (1 pce) g
Feed-through 2 connections	Grey	ZK6	1SNK708010R0000	50	11.80
	Blue	ZK6-BL	1SNK708020R0000	50	11.80
	Orange	ZK6-OR	1SNK708030R0000	50	11.80
	Yellow	ZK6-YL	1SNK708060R0000	50	11.80
	Red	ZK6-RD	1SNK708062R0000	50	11.80
	Black	ZK6-BK	1SNK708066R0000	50	11.80

Main technical data

Connecting capacity	IEC	UL - CSA	Rail	Wire stripping length	TH 35-7.5, TH 35-15
1 conductor per clamp	Rigid: Solid/Stranded	0.5 ... 10 mm²	24 ... 8 AWG	12.5 mm	0.492 in
	Flexible without ferrule	0.5 ... 6 mm²			
	Flexible with non insulated ferrule	0.5 ... 6 mm²	24 ... 10 AWG		
	Flexible with insulated ferrule	0.5 ... 6 mm²	24 ... 10 AWG		
2 conductors per clamp	Flexible with twin ferrule	0.5 ... 1.5 mm²	24 ... 16 AWG	Tool (for flexible conductor without ferrule)	Flat screwdriver Ø 3.5 mm Ø 0.138 in
Rated current / Rated cross section		41 A / 6 mm²	50 A / 8 AWG		
Rated short-time withstand current (1s)		720 A	1008 A		
Short Circuit Current Rating (with specific conditions)			100 kA		
Rated voltage		1000 V	600 V		
Impulse withstand voltage		8000 V			
Protection		IP20	NEMA 1		
Increased safety Ex e		693 V 37 A IEC/EN 60079-7 - IM2 II 2 GD Ex eb I/II/III/C			

The connecting capacity data for one Rigid: Solid/Stranded, or one Flexible conductor (when applicable) is a mandatory information required by IEC, UL and CSA standards (Copper conductors). All other data are provided as supplementary information only. For more details, please consult our CB, UL or CSA certificates and technical datasheet available on <http://www.TE.com>



Accessories

Description	Color	Type	Part Number	Pkg qty	Weight (1 pce) g	
1 End stops	Dark grey	BAZ1	1SNK900002R0000	50	5.30	
2 End sections	Dark grey	EK2.5	1SNK705910R0000	20	1.80	
3 Jumper bars	Orange	2 poles	JB8-2	1SNK908302R0000	50	2.70
		3 poles	JB8-3	1SNK908303R0000	50	4.10
		4 poles	JB8-4	1SNK908304R0000	50	5.60
		5 poles	JB8-5	1SNK908305R0000	40	7.00
		10 poles	JB8-10	1SNK908310R0000	20	14.20
4 Cross spacing jumpers	Orange	JB85-3	1SNK900603R0000	10	2.80	
5 Circuit separators	Dark grey	CS-R2	1SNK900106R0000	20	3.80	
6 Test adapters	Dark grey	For test plugs DIA 2 mm 0.079 in	TP2	1SNK900203R0000	20	1.70
		For test plugs DIA 4 mm 0.157 in	TP4	1SNK900205R0000	20	2.40
7 Test connectors	Dark grey	TC5-R1	1SNK900201R0000	10	5.20	
8 Spacers	Dark grey	2.8 mm	ES-TC8	1SNK900104R0000	10	1.40
		Blank marker	MG-CPM 13 41791	1SNB041791R0612	1680	0.27
		Blank card	MC812	1SNK160000R0000	22	10.00
9 Terminal block markers	White	Blank card	MC812PA	1SNK169999R0000	20	14.00
		Universal wire markers holder	UMH	1SNK900611R0000	10	0.20

Complete list of accessories is indicated in the terminal block datasheet including end stops. Some accessories such as jumper bars may modify the terminal block's ratings. Complete information available in the accessories section of the catalog.

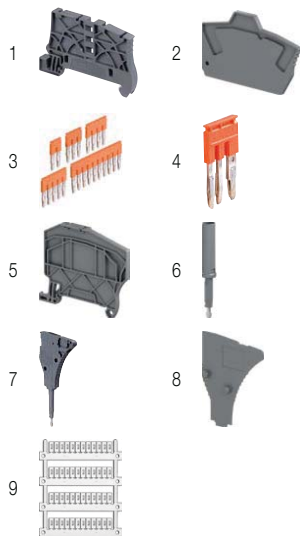

Ground PI-Spring terminal blocks

Description	Color	Type	Part Number	Pkg qty	Weight (1 pce) g
Ground	Green-yellow	ZK6-PE	1SNK708150R0000	20	20.30

Technical data valid for copper conductors only.



ZK6-3P PI-Spring terminal blocks

Feed-through with 3 connections - 8 mm 0.315 in spacing

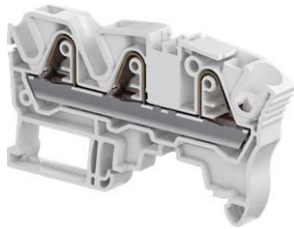

1SNK162019R0014

ZK6-3P

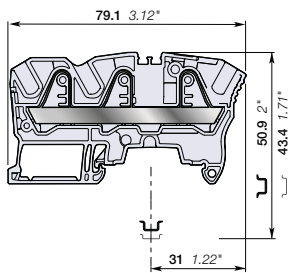

8 mm 0.315 in spacing

Description

Find all the features of the ZK6 terminal block with the added option of distributing or branching 3 conductors.

Ordering details

Description	Color	Type	Part Number	Pkg qty	Weight (1 pce) g
Feed-through 3 connections	Grey	ZK6-3P	1SNK708011R0000	50	16.70
	Blue	ZK6-3P-BL	1SNK708021R0000	50	16.70
	Orange	ZK6-3P-OR	1SNK708031R0000	50	16.70

Main technical data

Connecting capacity		IEC	UL - CSA	Mounting instructions	
1 conductor per clamp	Rigid: Solid/Stranded	0.5 ... 10 mm²	24 ... 8 AWG	Rail	TH 35-7.5, TH 35-15
	Flexible without ferrule	0.5 ... 6 mm²		Wire stripping length	12.5 mm 0.492 in
	Flexible with non insulated ferrule	0.5 ... 6 mm²	24 ... 10 AWG		
	Flexible with insulated ferrule	0.5 ... 6 mm²	24 ... 10 AWG		
2 conductors per clamp	Flexible with twin ferrule	0.5 ... 1.5 mm²	24 ... 16 AWG	Tool (for flexible conductor without ferrule)	Flat screwdriver Ø 3.5 mm Ø 0.138 in
Rated current / Rated cross section		41 A / 6 mm²	50 A / 8 AWG		
Rated short-time withstand current (1s)		720 A	1008 A		
Short Circuit Current Rating (with specific conditions)			100 kA		
Rated voltage		1000 V	600 V		
Impulse withstand voltage		8000 V			
Protection		IP20	NEMA 1		
Increased safety Ex e		693 V 37 A IEC/EN 60079-7 - IM2 II 2 GD Ex eb I/IC/IIIC			

The connecting capacity data for one Rigid: Solid/Stranded, or one Flexible conductor (when applicable) is a mandatory information required by IEC, UL and CSA standards (Copper conductors). All other data are provided as supplementary information only. For more details, please consult our CB, UL or CSA certificates and technical datasheet available on <http://www.TE.com>



Accessories

Description	Color	Type	Part Number	Pkg qty	Weight (1 pce) g	
1 End stops	Dark grey	BAZ1	1SNK900002R0000	50	5.30	
2 End sections	Dark grey	EK6-3P	1SNK708911R0000	20	2.80	
3 Jumper bars	Orange	2 poles	JB8-2	1SNK908302R0000	50	2.70
		3 poles	JB8-3	1SNK908303R0000	50	4.10
		4 poles	JB8-4	1SNK908304R0000	50	5.60
		5 poles	JB8-5	1SNK908305R0000	40	7.00
		10 poles	JB8-10	1SNK908310R0000	20	14.20
4 Cross spacing jumpers	Orange	JB85-3	1SNK900603R0000	10	2.80	
5 Circuit separators	Dark grey	CS-R3	1SNK900107R0000	20	6.40	
6 Test adapters	Dark grey	For test plugs DIA 2 mm 0.079 in	TP2	1SNK900203R0000	20	1.70
		For test plugs DIA 4 mm 0.157 in	TP4	1SNK900205R0000	20	2.40
7 Test connectors	Dark grey	TC5-R1	1SNK900201R0000	10	5.20	
8 Spacers	Dark grey	ES-TC8	1SNK900104R0000	10	1.40	
		MG-CPM 13 41791	1SNB041791R0612	1680	0.27	
		MC812	1SNK160000R0000	22	10.00	
9 Terminal block markers	White	Blank card	1SNK169999R0000	20	14.00	
		Universal wire markers holder	UMH	1SNK900611R0000	10	0.20

Complete list of accessories is indicated in the terminal block datasheet including end stops. Some accessories such as jumper bars may modify the terminal block's ratings. Complete information available in the accessories section of the catalog.

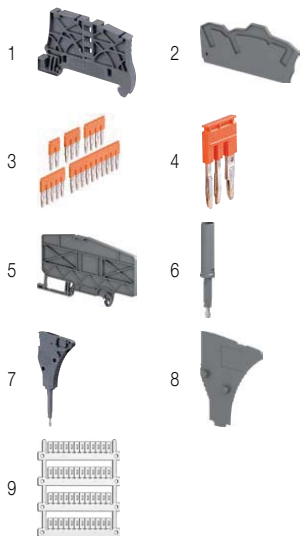

Ground PI-Spring terminal blocks

Description	Color	Type	Part Number	Pkg qty	Weight (1 pce) g
Ground	Green-yellow	ZK6-PE-3P	1SNK708151R0000	20	21.50

Technical data valid for copper conductors only.

ZK10 PI-Spring terminal blocks

Feed-through - 10 mm 0.394 in spacing

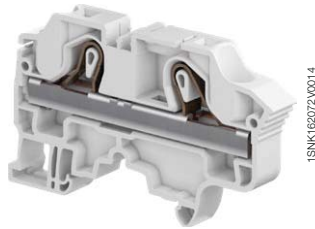

ZK10

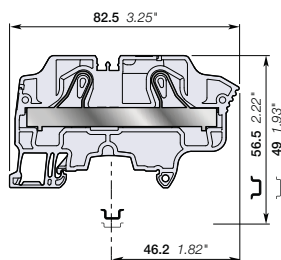

10 mm 0.394 in spacing

Description

Combine high performance with compact dimensions:

- 1000 V AC / DC IEC 600 V UL,
- Opt for the best marking visibility thanks to the up-front, flat marker zone, which lets you mark up to eight digits or increase the font size.

Ordering details

Description	Color	Type	Part Number	Pkg qty	Weight (1 pce) g
Feed-through 2 connections	Grey <input type="checkbox"/>	ZK10	1SNK710010R0000	20	27.20
	Blue <input type="checkbox"/>	ZK10-BL	1SNK710020R0000	20	27.20
	Orange <input type="checkbox"/>	ZK10-OR	1SNK710030R0000	20	27.20

Main technical data

Connecting capacity	IEC	UL - CSA	Mounting instructions
1 conductor per clamp	Rigid: Solid/Stranded	0.5 ... 16 mm ²	20 ... 6 AWG
	Flexible without ferrule	0.5 ... 10 mm ²	20 ... 8 AWG
	Flexible with non insulated ferrule	0.5 ... 10 mm ²	20 ... 8 AWG
	Flexible with insulated ferrule	0.5 ... 10 mm ²	20 ... 8 AWG
2 conductors per clamp	Flexible with twin ferrule	0.5 ... 4 mm ²	20 ... 12 AWG
Rated current / Rated cross section		57 A / 10 mm ²	55 A / 6 AWG
Rated short-time withstand current (1s)		1200 A	1596 A
Short Circuit Current Rating (with specific conditions)			100 kA
Rated voltage		1000 V	600 V
Impulse withstand voltage		8000 V	
Protection		IP20	NEMA 1
Increased safety Ex e		693 V 51 A IEC/EN 60079-7 - IM2 II 2 GD Ex eb I/II/C/IIIC	

The connecting capacity data for one Rigid: Solid/Stranded, or one Flexible conductor (when applicable) is a mandatory information required by IEC, UL and CSA standards (Copper conductors). All other data are provided as supplementary information only. For more details, please consult our CB, UL or CSA certificates and technical datasheet available on <http://www.TE.com>

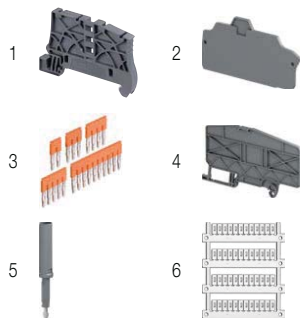

Accessories

Description	Color	Type	Part Number	Pkg qty	Weight (1 pce) g	
1 End stops	Dark grey <input type="checkbox"/>	BAZ1	1SNK900002R0000	50	5.30	
2 End sections	Dark grey <input type="checkbox"/>	EK10	1SNK710910R0000	20	3.30	
3 Jumper bars	Orange <input type="checkbox"/>	2 poles	JB10-2	1SNK910302R0000	50	4.60
		3 poles	JB10-3	1SNK910303R0000	50	7.10
		4 poles	JB10-4	1SNK910304R0000	40	9.40
		5 poles	JB10-5	1SNK910305R0000	30	12.00
		10 poles	JB10-10	1SNK910310R0000	20	24.00
4 Circuit separators	Dark grey <input type="checkbox"/>	CS-R3	1SNK900107R0000	20	6.40	
5 Test adapters	Dark grey <input type="checkbox"/>	For test plugs DIA 2 mm 0.079 in	TP2	1SNK900203R0000	20	1.70
		For test plugs DIA 4 mm 0.157 in	TP4	1SNK900205R0000	20	2.40
6 Terminal block markers	White <input type="checkbox"/>	Blank marker	MG-CPM 13 41791	1SNB041791R0612	1680	0.27
		Blank card	MC812	1SNK160000R0000	22	10.00
			MC812PA	1SNK169999R0000	20	14.00
	Universal wire markers holder	Grey <input type="checkbox"/>	UMH	1SNK900611R0000	10	0.20

Complete list of accessories is indicated in the terminal block datasheet including end stops.

Some accessories such as jumper bars may modify the terminal block's ratings: Complete information available in the accessories section of the catalog.



Ground PI-Spring terminal blocks

Description	Color	Type	Part Number	Pkg qty	Weight (1 pce) g
Ground	Green-yellow <input type="checkbox"/>	ZK10-PE	1SNK710150R0000	20	36.20

Technical data valid for copper conductors only.

ZK10-PV PI-Spring terminal blocks

Feed-through - 12 mm 0.472 in spacing

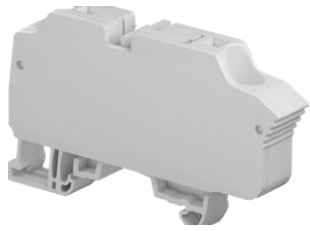
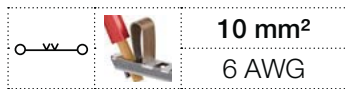

1SNK10212AV0014

Description

Specially designed for high voltage utility scale solar power plants:

- Rated voltage of 1500 V DC IEC and 1000 V DC UL,
- Pre-mounted end section with light grey color specific to this application,
- Improved design with ribs to increase creepage distance,
- Compact solution only 2 mm thicker than normal product,
- Compatible with JB12 jumpers to interconnect multiple terminal blocks.

Ordering details

Description	Color	Type	Part Number	Pkg qty	Weight (1 pce) g
Feed-through 2 connections	Grey	ZK10-PV	1SNK710063R0000	20	29.86
	Blue	ZK10-PV-BL	1SNK710065R0000	20	29.86

Main technical data

Connecting capacity	IEC	UL - CSA	Mounting instructions
1 conductor per clamp	Rigid: Solid/Stranded	20 ... 6 AWG	Rail
	Flexible without ferrule	20 ... 6 AWG	Wire stripping length
	Flexible with non insulated ferrule	20 ... 8 AWG	TH 35-7.5, TH 35-15
	Flexible with insulated ferrule	20 ... 8 AWG	15 mm 0.591 in
2 conductors per clamp	Flexible with twin ferrule	20 ... 12 AWG	Tool (for flexible conductor without ferrule)
			Flat screwdriver Ø 4 mm Ø 0.157 in
Rated current / Rated cross section		57 A / 10 mm²	
Rated short-time withstand current (1s)		1200 A	
Short Circuit Current Rating (with specific conditions)		55 A / 6 AWG	
Rated voltage		1000 V AC / 1500 V DC	
Impulse withstand voltage		1596 A	
Protection		100 kA	
		1000 V	
		8000 V	
		IP20	
		NEMA 1	

ZK10-PV

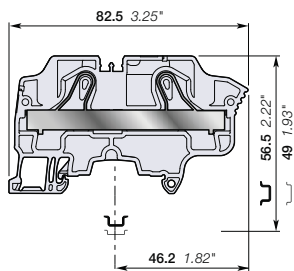

12 mm 0.472 in spacing

The connecting capacity data for one Rigid: Solid/Stranded, or one Flexible conductor (when applicable) is a mandatory information required by IEC, UL and CSA standards (Copper conductors). All other data are provided as supplementary information only. For more details, please consult our CB, UL or CSA certificates and technical datasheet available on <http://www.TE.com>



Accessories

Description	Color	Type	Part Number	Pkg qty	Weight (1 pce) g	
1 End stops	Dark grey	BAZ1	1SNK900002R0000	50	5.30	
2 Jumper bars	Orange	2 poles	JB12-2	1SNK912302R0000	50	4.90
		3 poles	JB12-3	1SNK912303R0000	50	7.60
		5 poles	JB12-5	1SNK912305R0000	20	12.90
3 Circuit separators	Dark grey	3 mm	CS-R3	1SNK900107R0000	20	6.40
4 Test adapters	Dark grey	For test plugs DIA 2 mm 0.079 in	TP2	1SNK900203R0000	20	1.70
		For test plugs DIA 4 mm 0.157 in	TP4	1SNK900205R0000	20	2.40
5 Terminal block markers	White	Blank card	MC812	1SNK160000R0000	22	10.00
			MC812PA	1SNK169999R0000	20	14.00
	Blank marker	MG-CPM 13 41791	1SNK041791R0612	1680	0.273	
	Universal wire markers holder	Grey	UMH	1SNK900611R0000	10	0.273

Complete list of accessories is indicated in the terminal block datasheet including end stops. Some accessories such as jumper bars may modify the terminal block's ratings: Complete information available in the accessories section of the catalog.



Ground PI-Spring terminal blocks

Description	Color	Type	Part Number	Pkg qty	Weight (1 pce) g
Ground	Green-yellow	ZK10-PE	1SNK710150R0000	20	36.20

Technical data valid for copper conductors only.

ZK10-3P PI-Spring terminal blocks

Feed-through with 3 connections - 10 mm 0.394 in spacing



ZK10-3P

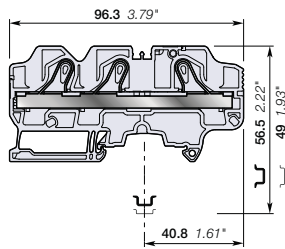

10 mm 0.394 in spacing

Description

- Find all the features of the ZK10 terminal block with the added option of distributing or branching 3 conductors,
- ZK10-3P is perfectly adapted to solar applications: 1250 V DC (1000 V AC) IEC, 1000 V UL.

Ordering details

Description	Color	Type	Part Number	Pkg qty	Weight (1 pce) g
Feed-through 3 connections	Grey <input type="checkbox"/>	ZK10-3P	1SNK710011R0000	20	34.9
	Blue <input type="checkbox"/>	ZK10-3P-BL	1SNK710021R0000	20	34.9

Main technical data

Connecting capacity	IEC	UL - CSA	Rail	Mounting instructions
1 conductor per clamp	Rigid: Solid/Stranded	0.5 ... 16 mm ²	20 ... 6 AWG	 Wire stripping length 15 mm 0.591 in
	Flexible without ferrule	0.5 ... 10 mm ²		
	Flexible with non insulated ferrule	0.5 ... 10 mm ²	20 ... 8 AWG	
	Flexible with insulated ferrule	0.5 ... 10 mm ²	20 ... 8 AWG	
2 conductors per clamp	Flexible with twin ferrule	0.5 ... 4 mm ²	20 ... 12 AWG	 Tool (for flexible conductor without ferrule) Flat screwdriver Ø 4 mm Ø 0.157 in
Rated current / Rated cross section		57 A / 10 mm ²	56 A / 6 AWG	
Rated short-time withstand current (1s)		1200 A		
Short Circuit Current Rating (with specific conditions)			100 kA	
Rated voltage		1000 V	1000 V	
Impulse withstand voltage		8000 V		
Protection		IP20	NEMA 1	
Increased safety Ex e		693 V 57 A - IM2 II 2 GD Ex eb I/IIIC		

The connecting capacity data for one Rigid: Solid/Stranded, or one Flexible conductor (when applicable) is a mandatory information required by IEC, UL and CSA standards (Copper conductors). All other data are provided as supplementary information only. For more details, please consult our CB, UL or CSA certificates and technical datasheet available on <http://www.TE.com>

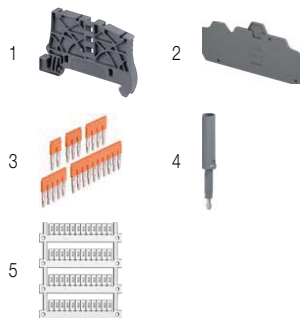

Accessories

Description	Color	Type	Part Number	Pkg qty	Weight (1 pce) g	
1 End stops	Dark grey <input type="checkbox"/>	BAZ1	1SNK900002R0000	50	5.30	
2 End sections	Dark grey <input type="checkbox"/>	EK10-3P	1SNK710911R0000	20	4.5	
3 Jumper bars	Orange <input type="checkbox"/>	2 poles	JB10-2	1SNK910302R0000	50	4.60
		3 poles	JB10-3	1SNK910303R0000	50	7.10
		4 poles	JB10-4	1SNK910304R0000	40	9.40
		5 poles	JB10-5	1SNK910305R0000	30	12.00
		10 poles	JB10-10	1SNK910310R0000	20	24.00
4 Test adapters	Dark grey <input type="checkbox"/>	For test plugs DIA 2 mm 0.079 in	TP2	1SNK900203R0000	20	1.70
		For test plugs DIA 4 mm 0.157 in	TP4	1SNK900205R0000	20	2.40
5 Terminal block markers	White <input type="checkbox"/>	Blank marker	MG-CPM 13 41791	1SNB041791R0612	1680	0.27
		Blank card	MC812	1SNK160000R0000	22	10.00
			MC812PA	1SNK169999R0000	20	14.00
		Universal wire markers holder	Grey <input type="checkbox"/>	UMH	1SNK900611R0000	10

Complete list of accessories is indicated in the terminal block datasheet including end stops. Some accessories such as jumper bars may modify the terminal block's ratings: Complete information available in the accessories section of the catalog.



Ground PI-Spring terminal blocks

Description	Color	Type	Part Number	Pkg qty	Weight (1 pce) g
Ground	Green-yellow <input type="checkbox"/>	ZK10-PE-3P	1SNK710151R0000	20	43.3

Technical data valid for copper conductors only.

ZK10-3P-PV PI-Spring terminal blocks

Feed-through with 3 connections - 12 mm 0.472 in spacing

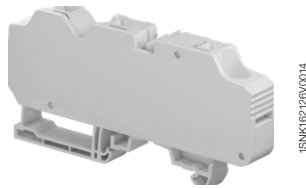

ZK10-3P-PV

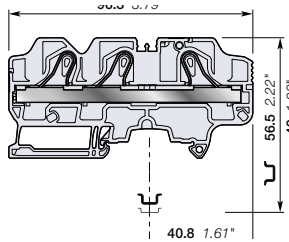

12 mm 0.472 in spacing

Description

Specially designed for high voltage utility scale solar power plants:

- Rated voltage of 1500 V DC IEC and 1000 V DC UL,
- Pre-mounted end section with light grey color specific to this application,
- Improved design with ribs to increase creepage distance,
- Compact solution only 2 mm thicker than normal product,
- 3 connections configuration for easy grouping: 2 inputs / 1 output or 1 input / 2 outputs,
- Compatible with JB12 jumpers to interconnect multiple terminal blocks.

Description	Color	Type	Part Number	Pkg qty	Weight (1 pce) g
Feed-through 3 connections	Grey	ZK10-3P-PV	1SNK710064R0000	20	38.61
	Blue, grey	ZK10-3P-PV-BL	1SNK710067R0000	20	38.61

Main technical data

Connecting capacity		IEC	UL - CSA	Rail	Wire stripping length	TH 35-7.5, TH 35-15
1 conductor per clamp	Rigid: Solid/Stranded	0.5 ... 16 mm ²	20 ... 6 AWG	Tool (for flexible conductor without ferrule)	15 mm 0.591 in	Flat screwdriver Ø 4 mm Ø 0.157 in
	Flexible without ferrule	0.5 ... 10 mm ²	20 ... 8 AWG			
	Flexible with non insulated ferrule	0.5 ... 10 mm ²	20 ... 8 AWG			
	Flexible with insulated ferrule	0.5 ... 10 mm ²	20 ... 8 AWG			
2 conductors per clamp	Flexible with twin ferrule	0.5 ... 4 AWG	20 ... 12 AWG			
Rated current / Rated cross section		57 A / 10 mm ²	56 A / 6 AWG			
Rated short-time withstand current (1s)		1200 A	1596 A			
Short Circuit Current Rating (with specific conditions)			100 kA			
Rated voltage		1000 V AC / 1500 V DC	1000 V			
Impulse withstand voltage		8000 V				
Protection		IP20	NEMA 1			

The connecting capacity data for one Rigid: Solid/Stranded, or one Flexible conductor (when applicable) is a mandatory information required by IEC, UL and CSA standards (Copper conductors). All other data are provided as supplementary information only. For more details, please consult our CB, UL or CSA certificates and technical datasheet available on <http://www.TE.com>

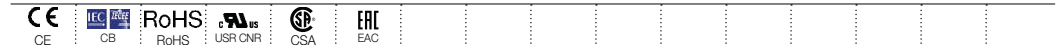

Accessories

Description	Color	Type	Part Number	Pkg qty	Weight (1 pce) g	
1 End stops	Dark grey	BAZ1	1SNK900002R0000	50	5.30	
2 Jumper bars	Orange	2 poles	JB12-2	1SNK912302R0000	50	4.90
		3 poles	JB12-3	1SNK912303R0000	50	7.60
		5 poles	JB12-5	1SNK912305R0000	20	12.90
3 Circuit separators	Dark grey	CS-R3	1SNK900107R0000	20	6.40	
4 Test adapters	Dark grey	For test plugs DIA 2 mm 0.079 in	TP2	1SNK900203R0000	20	1.70
		For test plugs DIA 4 mm 0.157 in	TP4	1SNK900205R0000	20	2.40
5 Terminal block markers	White	Blank card	MC812	1SNK160000R0000	22	10.00
			MC812PA	1SNK169999R0000	20	14.00
		Blank marker	MG-CPM 13 41791	1SNB041791R0612	1680	0.273
	Universal wire markers holder	Grey	UMH	1SNK900611R0000	10	0.20

Complete list of accessories is indicated in the terminal block datasheet including end stops. Some accessories such as jumper bars may modify the terminal block's ratings: Complete information available in the accessories section of the catalog.



Ground PI-Spring terminal blocks

Description	Color	Type	Part Number	Pkg qty	Weight (1 pce) g
Ground Profile aligned with ZK10-3P	Green-yellow	ZK10-PE-3P	1SNK710151R0000	20	43.3



Technical data valid for copper conductors only.

ZK16 PI-Spring terminal blocks

Feed-through - 12 mm 0.472 in spacing



16 mm²
4 AWG

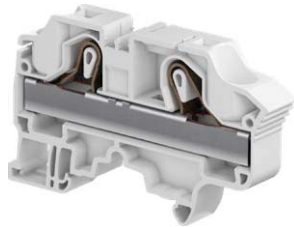

1SNK162075V0014

ZK16

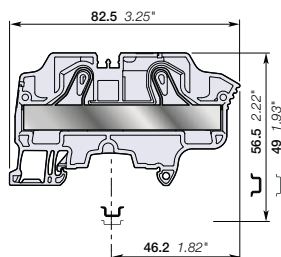

12 mm 0.472 in spacing

Description

Combine high performance with compact dimensions:

- 1000 V AC / DC IEC 600 V UL,
- Opt for the best marking visibility thanks to the up-front, flat marker zone, which lets you mark up to eight digits or increase the font size.

Ordering details

Description	Color	Type	Part Number	Pkg qty	Weight (1 pce) g
Feed-through 2 connections	Grey <input type="checkbox"/>	ZK16	1SNK712010R0000	20	33.80
	Blue <input type="checkbox"/>	ZK16-BL	1SNK712020R0000	20	33.80

Main technical data

Connecting capacity		IEC	UL - CSA	Mounting instructions	
1 conductor per clamp	Rigid: Solid/Stranded	0.5 ... 25 mm ²	20 ... 4 AWG	Rail	TH 35-7.5, TH 35-15
	Flexible without ferrule	0.5 ... 16 mm ²	20 ... 6 AWG	Wire stripping length	15 mm 0.591 in
	Flexible with non insulated ferrule	0.5 ... 16 mm ²	20 ... 6 AWG	Tool (for flexible conductor without ferrule)	Flat screwdriver Ø 4 mm Ø 0.157 in
	Flexible with insulated ferrule	0.5 ... 16 mm ²	20 ... 6 AWG		
2 conductors per clamp	Flexible with twin ferrule	0.5 ... 6 mm ²	20 ... 10 AWG		
Rated current / Rated cross section		76 A / 16 mm ²	75 A / 4 AWG		
Rated short-time withstand current (1s)		1920 A	2544 A		
Short Circuit Current Rating (with specific conditions)			100 kA		
Rated voltage		1000 V	600 V		
Impulse withstand voltage		8000 V			
Protection		IP20	NEMA 1		
Increased safety Ex e		693 V 69 A IEC/EN 60079-7 - IM2 II 2 GD Ex eb I/II/III/C			

The connecting capacity data for one Rigid: Solid/Stranded, or one Flexible conductor (when applicable) is a mandatory information required by IEC, UL and CSA standards (Copper conductors). All other data are provided as supplementary information only. For more details, please consult our CB, UL or CSA certificates and technical datasheet available on <http://www.TE.com>

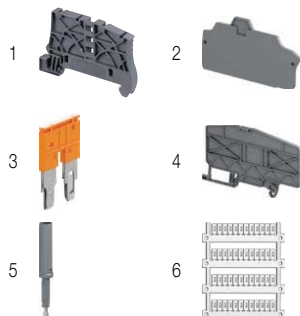

Accessories

Description	Color	Type	Part Number	Pkg qty	Weight (1 pce) g	
1 End stops	Dark grey <input type="checkbox"/>	BAZ1	1SNK900002R0000	50	5.30	
2 End sections	Dark grey <input type="checkbox"/>	EK10	1SNK710910R0000	20	3.30	
3 Jumper bars	Orange <input type="checkbox"/>	2 poles	JB12-2	1SNK912302R0000	50	4.90
		3 poles	JB12-3	1SNK912303R0000	50	7.60
		5 poles	JB12-5	1SNK912305R0000	20	12.90
4 Circuit separators	Dark grey <input type="checkbox"/>	3 mm	CS-R3	1SNK900107R0000	20	6.40
5 Test adapters	Dark grey <input type="checkbox"/>	For test plugs DIA 2 mm 0.079 in	TP2	1SNK900203R0000	20	1.70
		For test plugs DIA 4 mm 0.157 in	TP4	1SNK900205R0000	20	2.40
6 Terminal block markers	White <input type="checkbox"/>	Blank marker	MG-CPM 13 41791	1SNB041791R0612	1680	0.27
		Blank card	MC812	1SNK160000R0000	22	10.00
			MC812PA	1SNK169999R0000	20	14.00
	Universal wire markers holder	Grey <input type="checkbox"/>	UMH	1SNK900611R0000	10	0.20

Complete list of accessories is indicated in the terminal block datasheet including end stops.

Some accessories such as jumper bars may modify the terminal block's ratings: Complete information available in the accessories section of the catalog.



Ground PI-Spring terminal blocks

Description	Color	Type	Part Number	Pkg qty	Weight (1 pce) g
Ground	Green-yellow <input type="checkbox"/>	ZK16-PE	1SNK712150R0000	20	47.00

Technical data valid for copper conductors only.

ZK16-PV PI-Spring terminal blocks

Feed-through - 14 mm 0.551 in spacing

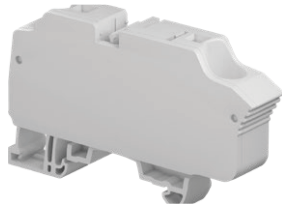

1SNK162128V0014

Description

- Specially designed for high voltage utility scale solar power plants:
- Rated voltage of 1500 V DC IEC and 1000 V DC UL,
 - Pre-mounted end section with light grey color specific to this application,
 - Improved design with ribs to increase creepage distance,
 - Compact solution only 2 mm thicker than normal product,
 - No available jumpers for ZK16-PV and ZK16-3P-PV (14 mm spacing).

Ordering details

Description	Color	Type	Part Number	Pkg qty	Weight (1 pce) g
Feed-through 2 connections	Grey <input type="checkbox"/>	ZK16-PV	1SNK712063R0000	15	36.56
	Blue <input type="checkbox"/>	ZK16-PV-BL	1SNK712065R0000	15	36.56

Main technical data

Connecting capacity	IEC	UL - CSA	Mounting instructions	
1 conductor per clamp	Rigid: Solid/Stranded	0.5 ... 25 mm ²	20 ... 4 AWG	Rail TH 35-7.5, TH 35-15
	Flexible without ferrule	0.5 ... 16 mm ²	20 ... 4 AWG	Wire stripping length 15 mm 0.591 in
	Flexible with non insulated ferrule	0.5 ... 16 mm ²	20 ... 6 AWG	Tool (for flexible conductor without ferrule) Flat screwdriver Ø 4 mm Ø 0.157 in
	Flexible with insulated ferrule	0.5 ... 16 mm ²	20 ... 6 AWG	
2 conductors per clamp	Flexible with twin ferrule	0.5 ... 6 AWG	20 ... 10 AWG	
Rated current / Rated cross section		76 A / 16 mm ²	75 A / 4 AWG	
Rated short-time withstand current (1s)		1920 A	2544 A	
Short Circuit Current Rating (with specific conditions)			100 kA	
Rated voltage		1000 V AC / 1500 V DC	1000 V	
Impulse withstand voltage		8000 V		
Protection		IP20	NEMA 1	

ZK16-PV

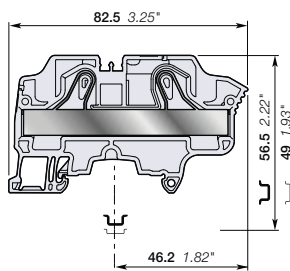

14 mm 0.551 in spacing

The connecting capacity data for one Rigid: Solid/Stranded, or one Flexible conductor (when applicable) is a mandatory information required by IEC, UL and CSA standards (Copper conductors). All other data are provided as supplementary information only. For more details, please consult our CB, UL or CSA certificates and technical datasheet available on <http://www.TE.com>

CE	CB	RoHS	UL	CSA	EAC				

Accessories

Description	Color	Type	Part Number	Pkg qty	Weight (1 pce) g
1 End stops	Dark grey <input checked="" type="checkbox"/>	BAZ1	1SNK900002R0000	50	5.30
2 Circuit separators	Dark grey <input checked="" type="checkbox"/>	CS-R3	1SNK900107R0000	20	6.40
3 Test adapters	Dark grey <input checked="" type="checkbox"/>	TP2	1SNK900203R0000	20	1.70
		TP4	1SNK900205R0000	20	2.40
4 Terminal block markers	White <input type="checkbox"/>	MC812	1SNK160000R0000	22	10.00
		MC812PA	1SNK169999R0000	20	14.00
		MG-CPM 13 41791	1SNB041791R0612	1680	0.273
	Grey <input type="checkbox"/>	UMH	1SNK900611R0000	10	0.20

Complete list of accessories is indicated in the terminal block datasheet including end stops. Some accessories such as jumper bars may modify the terminal block's ratings. Complete information available in the accessories section of the catalog.

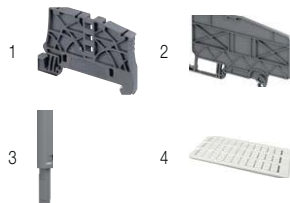

Ground PI-Spring terminal blocks

Description	Color	Type	Part Number	Pkg qty	Weight (1 pce) g
Ground	Green-yellow <input checked="" type="checkbox"/>	ZK16-PE	1SNK712150R0000	20	47.00

Technical data valid for copper conductors only.

ZK16-3P PI-Spring terminal blocks

Feed-through with 3 connections - 12 mm 0.472 in spacing



ZK16-3P

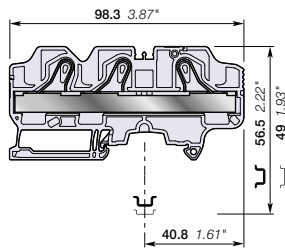

12 mm 0.472 in spacing

Description

- Find all the features of the ZK16 terminal block with the added option of distributing or branching 3 conductors,
- ZK16-3P is perfectly adapted to solar applications: 1250 V DC (1000 V AC) IEC, 1000 V UL.

Ordering details

Description	Color	Type	Part Number	Pkg qty	Weight (1 pce) g
Feed-through 3 connections	Grey <input type="checkbox"/>	ZK16-3P	1SNK712011R0000	20	44.3
	Blue <input type="checkbox"/>	ZK16-3P-BL	1SNK712021R0000	20	44.3

Main technical data

Connecting capacity	IEC	UL - CSA	Rail	Wire stripping length	TH 35-7.5, TH 35-15
1 conductor per clamp	Rigid: Solid/Stranded	0.5 ... 25 mm ²	20 ... 4 AWG	15 mm	0.591 in
	Flexible without ferrule	0.5 ... 16 mm ²			
	Flexible with non insulated ferrule	0.5 ... 16 mm ²	20 ... 6 AWG		
	Flexible with insulated ferrule	0.5 ... 16 mm ²	20 ... 6 AWG		
2 conductors per clamp	Flexible with twin ferrule	0.5 ... 6 mm ²	20 ... 10 AWG	Tool (for flexible conductor without ferrule)	Flat screwdriver Ø 4 mm Ø 0.157 in
Rated current / Rated cross section		76 A / 16 mm ²	75 A / 4 AWG		
Rated short-time withstand current (1s)		1920 A			
Short Circuit Current Rating (with specific conditions)			100 kA		
Rated voltage		1000 V	1000 V		
Impulse withstand voltage		8000 V			
Protection		IP20	NEMA 1		
Increased safety Ex e		693 V 76 A - IM2 II 2 GD Ex eb I/II/III C			

The connecting capacity data for one Rigid: Solid/Stranded, or one Flexible conductor (when applicable) is a mandatory information required by IEC, UL and CSA standards (Copper conductors). All other data are provided as supplementary information only. For more details, please consult our CB, UL or CSA certificates and technical datasheet available on <http://www.TE.com>

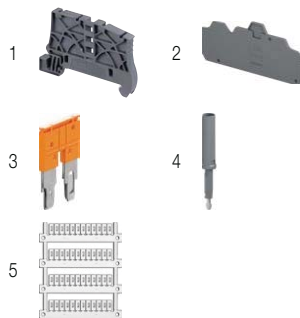

Accessories

Description	Color	Type	Part Number	Pkg qty	Weight (1 pce) g	
1 End stops	Dark grey <input type="checkbox"/>	BAZ1	1SNK900002R0000	50	5.30	
2 End sections	Dark grey <input type="checkbox"/>	EK10-3P	1SNK710911R0000	20	4.5	
3 Jumper bars	Orange <input type="checkbox"/>	2 poles	JB12-2	1SNK912302R0000	50	4.90
		3 poles	JB12-3	1SNK912303R0000	50	7.60
		5 poles	JB12-5	1SNK912305R0000	20	12.90
4 Test adapters	Dark grey <input type="checkbox"/>	For test plugs DIA 2 mm 0.079 in	TP2	1SNK900203R0000	20	1.70
		For test plugs DIA 4 mm 0.157 in	TP4	1SNK900205R0000	20	2.40
5 Terminal block markers	White <input type="checkbox"/>	Blank marker	MG-CPM 13 41791	1SNB041791R0612	1680	0.27
		Blank card	MC812	1SNK160000R0000	22	10.00
			MC812PA	1SNK169999R0000	20	14.00
	Universal wire markers holder	Grey <input type="checkbox"/>	UMH	1SNK900611R0000	10	0.20

Complete list of accessories is indicated in the terminal block datasheet including end stops.

Some accessories such as jumper bars may modify the terminal block's ratings: Complete information available in the accessories section of the catalog.



Ground PI-Spring terminal blocks

Description	Color	Type	Part Number	Pkg qty	Weight (1 pce) g
Ground	Green-yellow <input type="checkbox"/>	ZK16-PE-3P	1SNK712151R0000	20	56.65

Technical data valid for copper conductors only.

ZK16-3P-PV PI-Spring terminal blocks

Feed-through with 3 connections - 14 mm 0.551 in spacing



16 mm²
4 AWG

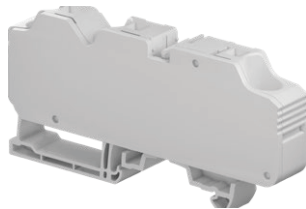

1SNK1621SDV0014

ZK16-3P-PV

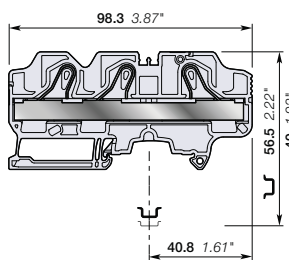

14 mm 0.551 in spacing

Description

Specially designed for high voltage utility scale solar power plants:

- Rated voltage of 1500 V DC IEC and 1000 V DC UL,
- Pre-mounted end section with light grey color specific to this application,
- Improved design with ribs to increase creepage distance,
- Compact solution only 2 mm thicker than normal product,
- 3 connections configuration for easy grouping: 2 inputs / 1 output or 1 input / 2 outputs,
- No available jumpers for ZK16-PV and ZK16-3P-PV (14 mm spacing).

Ordering details

Description	Color	Type	Part Number	Pkg qty	Weight (1 pce) g
Feed-through 3 connections	Grey <input type="checkbox"/>	ZK16-3P-PV	1SNK712064R0000	15	48.01
	Blue <input type="checkbox"/>	ZK16-3P-PV-BL	1SNK712067R0000	15	48.01

Main technical data

Connecting capacity		IEC	UL - CSA	Mounting instructions	
1 conductor per clamp	Rigid: Solid/Stranded	0.5 ... 25 mm ²	20 ... 4 AWG	Rail	TH 35-7.5, TH 35-15
	Flexible without ferrule	0.5 ... 16 mm ²		Wire stripping length	15 mm 0.591 in
	Flexible with non insulated ferrule	0.5 ... 16 mm ²	20 ... 6 AWG		
	Flexible with insulated ferrule	0.5 ... 16 mm ²	20 ... 6 AWG		
2 conductors per clamp	Flexible with twin ferrule	0.5 ... 6 AWG	20 ... 10 AWG	Tool (for flexible conductor without ferrule)	Flat screwdriver Ø 4 mm Ø 0.157 in
Rated current / Rated cross section		76 A / 16 mm ²	75 A / 4 AWG		
Rated short-time withstand current (1s)		1920 A	2544 A		
Short Circuit Current Rating (with specific conditions)			100 kA		
Rated voltage		1000 V AC / 1500 V DC	1000 V		
Impulse withstand voltage		8000 V			
Protection		IP20	NEMA 1		

The connecting capacity data for one Rigid: Solid/Stranded, or one Flexible conductor (when applicable) is a mandatory information required by IEC, UL and CSA standards (Copper conductors). All other data are provided as supplementary information only. For more details, please consult our CB, UL or CSA certificates and technical datasheet available on <http://www.TE.com>

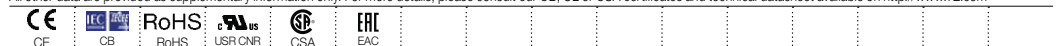

Accessories

Description	Color	Type	Part Number	Pkg qty	Weight (1 pce) g
1 End stops 5.2 mm 0.205 in	Dark grey <input type="checkbox"/>	BAZ1	1SNK900002R0000	50	5.30
2 Circuit separators 3 mm 0.118 in	Dark grey <input type="checkbox"/>	CS-R3	1SNK900107R0000	20	6.40
3 Test adapters For test plugs DIA 2 mm 0.079 in	Dark grey <input type="checkbox"/>	TP2	1SNK900203R0000	20	1.70
		TP4	1SNK900205R0000	20	2.40
4 Terminal block markers	White <input type="checkbox"/>	MC812	1SNK160000R0000	22	10.00
		MC812PA	1SNK169999R0000	20	14.00
	Grey <input type="checkbox"/>	MG-CPM 13 41791	1SNB041791R0612	1680	0.273
		UMH	1SNK900611R0000	10	0.20

Complete list of accessories is indicated in the terminal block datasheet including end stops.

Some accessories such as jumper bars may modify the terminal block's ratings: Complete information available in the accessories section of the catalog.

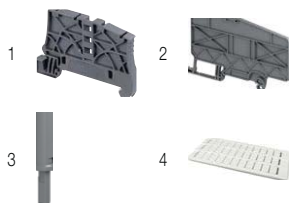

Ground PI-Spring terminal blocks

Description	Color	Type	Part Number	Pkg qty	Weight (1 pce) g
Ground Profile aligned with ZK16-3P	Green-yellow <input type="checkbox"/>	ZK16-PE-3P	1SNK712151R0000	20	56.65

Technical data valid for copper conductors only.

ZK2.5-PE PI-Spring terminal blocks

Ground - 5.2 mm 0.205 in spacing



ZK2.5-PE

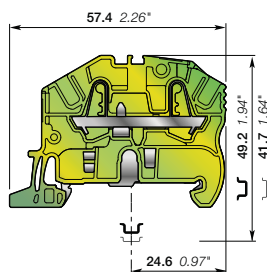

5.2 mm 0.205 in spacing

Description

Improve the safety of your installation in the event of a short-circuit thanks to our screwless rail contact:

- Rail contact non operator dependent,
- Performances above the requirements of the IEC 60947-7-2 terminal block standard,
- Secured snap on or off the rail,
- Profile aligned with ZK2.5.

Ordering details

Description	Color	Type	Part Number	Pkg qty	Weight (1 pce) g
Ground 2 connections	Green-yellow	ZK2.5-PE	1SNK705150R0000	20	10.00

Main technical data

Connecting capacity		IEC	UL - CSA	Mounting instructions
1 conductor per clamp	Rigid: Solid/Stranded	0.2 ... 4 mm²	26 ... 12 AWG	Rail
	Flexible without ferrule	0.22 ... 2.5 mm²		Wire stripping length
	Flexible with non insulated ferrule	0.22 ... 2.5 mm²	26 ... 14 AWG	
	Flexible with insulated ferrule	0.22 ... 2.5 mm²	26 ... 14 AWG	
Rated cross section		2.5 mm²	12 AWG	Tool (for flexible conductor without ferrule)
Rated short-time withstand current (1s)		300 A	396 A	Flat screwdriver Ø 3.5 mm Ø 0.138 in
Protection		IP20	NEMA 1	
Explosive atmosphere classification		IM2 II 2 GD Ex eb I/IC/IIIC - Class I, Zone 1, AEx e II, Ex e II U		

The connecting capacity data for one Rigid: Solid/Stranded, or one Flexible conductor (when applicable) is a mandatory information required by IEC, UL and CSA standards (Copper conductors). All other data are provided as supplementary information only. For more details, please consult our CB, UL or CSA certificates and technical datasheet available on <http://www.TE.com>

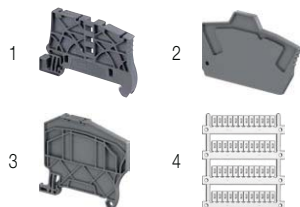

Accessories

Description	Color	Type	Part Number	Pkg qty	Weight (1 pce) g
1 End stops	Dark grey	BAZ1	1SNK900002R0000	50	5.30
2 End sections	Dark grey	EK2.5	1SNK705910R0000	20	1.80
3 Circuit separators	Dark grey	CS-R2	1SNK900106R0000	20	3.80
4 Terminal block markers	White	MG-CPM 13 41790	1SNB041790R0512	1960	0.23
		MC512	1SNK140000R0000	22	9.00
		MC512PA	1SNK149999R0000	20	10.00
Universal wire markers holder	Grey	UMH	1SNK900611R0000	10	0.20

Complete list of accessories is indicated in the terminal block datasheet including end stops. Some accessories such as jumper bars may modify the terminal block's ratings: Complete information available in the accessories section of the catalog.

Technical data valid for copper conductors only.

ZK2.5-PE-3P PI-Spring terminal blocks

Ground with 3 connections - 5.2 mm 0.205 in spacing



ZK2.5-PE-3P

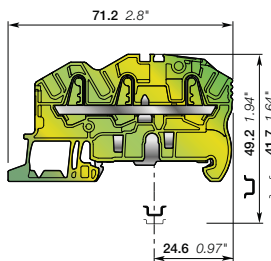

5.2 mm 0.205 in spacing

Description

Improve the safety of your installation in the event of a short-circuit thanks to our screwless rail contact:

- Rail contact non operator dependent,
- Performances above the requirements of the IEC 60947-7-2 terminal block standard,
- Secured snap on or off the rail,
- Profile aligned with ZK2.5-3P.

Ordering details

Description	Color	Type	Part Number	Pkg qty	Weight (1 pce) g
Ground 3 connections	Green-yellow	ZK2.5-PE-3P	1SNK705151R0000	20	11.90

Main technical data

Connecting capacity	IEC	UL - CSA	Rail	Wire stripping length	Tool (for flexible conductor without ferrule)
1 conductor per clamp	Rigid: Solid/Stranded	0.2 ... 4 mm ²	26 ... 12 AWG	11 mm 0.433 in	Flat screwdriver Ø 3.5 mm Ø 0.138 in
	Flexible without ferrule	0.22 ... 2.5 mm ²	26 ... 14 AWG		
	Flexible with non insulated ferrule	0.22 ... 2.5 mm ²	26 ... 14 AWG		
	Flexible with insulated ferrule	0.22 ... 2.5 mm ²	26 ... 14 AWG		
Rated cross section	2.5 mm ²	12 AWG			
Rated short-time withstand current (1s)	300 A	396 A			
Protection	IP20	NEMA 1			
Explosive atmosphere classification	IM2 II 2 GD Ex eb IIC/IIIC - Class I, Zone 1, AEx e II, Ex e II U				

The connecting capacity data for one Rigid: Solid/Stranded, or one Flexible conductor (when applicable) is a mandatory information required by IEC, UL and CSA standards (Copper conductors). All other data are provided as supplementary information only. For more details, please consult our CB, UL or CSA certificates and technical datasheet available on <http://www.TE.com>



Accessories

Description	Color	Type	Part Number	Pkg qty	Weight (1 pce) g
1 End stops	Dark grey	BAZ1	1SNK900002R0000	50	5.30
2 End sections	Dark grey	EK2.5-3P	1SNK705911R0000	20	2.40
3 Circuit separators	Dark grey	CS-R3	1SNK900107R0000	20	6.40
4 Terminal block markers	White	MG-CPM 13 41790	1SNB041790R0512	1960	0.23
		MC512	1SNK140000R0000	22	9.00
		MC512PA	1SNK149999R0000	20	10.00
Universal wire markers holder	Grey	UMH	1SNK900611R0000	10	0.20

Complete list of accessories is indicated in the terminal block datasheet including end stops. Some accessories such as jumper bars may modify the terminal block's ratings. Complete information available in the accessories section of the catalog.

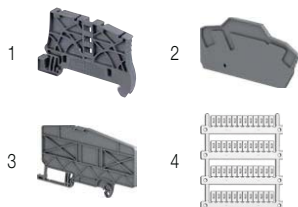

Technical data valid for copper conductors only.

ZK2.5-PE-4P PI-Spring terminal blocks

Ground with 4 connections - 5.2 mm 0.205 in spacing



ZK2.5-PE-4P

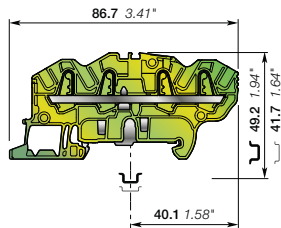

5.2 mm 0.205 in spacing

Description

Improve the safety of your installation in the event of a short-circuit thanks to our screwless rail contact:

- Rail contact non operator dependent,
- Performances above the requirements of the IEC 60947-7-2 terminal block standard,
- Secured snap on or off the rail,
- Profile aligned with ZK2.5-4P.

Ordering details

Description	Color	Type	Part Number	Pkg qty	Weight (1 pce) g
Ground 4 connections	Green-yellow	ZK2.5-PE-4P	1SNK705152R0000	20	13.60

Main technical data

Connecting capacity		IEC	UL - CSA	Mounting instructions	
1 conductor per clamp	Rigid: Solid/Stranded	0.2 ... 4 mm ²	26 ... 12 AWG	Rail	TH 35-7.5, TH 35-15
	Flexible without ferrule	0.22 ... 2.5 mm ²	26 ... 14 AWG	Wire stripping length	11 mm 0.433 in
	Flexible with non insulated ferrule	0.22 ... 2.5 mm ²	26 ... 14 AWG		
	Flexible with insulated ferrule	0.22 ... 2.5 mm ²	26 ... 14 AWG	Tool (for flexible conductor without ferrule)	Flat screwdriver Ø 3.5 mm Ø 0.138 in
Rated cross section		2.5 mm ²	12 AWG		
Rated short-time withstand current (1s)		300 A	396 A		
Protection		IP20	NEMA 1		
Explosive atmosphere classification		IM2 II 2 GD Ex eb I/IC/IIIC - Class I, Zone 1, AEx e II, Ex e II U			

The connecting capacity data for one Rigid: Solid/Stranded, or one Flexible conductor (when applicable) is a mandatory information required by IEC, UL and CSA standards (Copper conductors). All other data are provided as supplementary information only. For more details, please consult our CB, UL or CSA certificates and technical datasheet available on <http://www.TE.com>

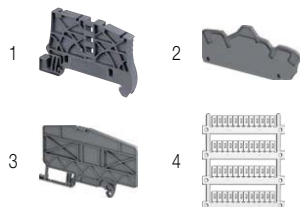

Accessories

Description	Color	Type	Part Number	Pkg qty	Weight (1 pce) g
1 End stops	Dark grey	BAZ1	1SNK900002R0000	50	5.30
2 End sections	Dark grey	EK2.5-4P	1SNK705912R0000	20	2.70
3 Circuit separators	Dark grey	CS-R3	1SNK900107R0000	20	6.40
4 Terminal block markers	White	MG-CPM 13 41790	1SNB041790R0512	1960	0.23
		MC512	1SNK140000R0000	22	9.00
		MC512PA	1SNK149999R0000	20	10.00
Universal wire markers holder	Grey	UMH	1SNK900611R0000	10	0.20

Complete list of accessories is indicated in the terminal block datasheet including end stops.

Some accessories such as jumper bars may modify the terminal block's ratings: Complete information available in the accessories section of the catalog.

Technical data valid for copper conductors only.

ZK4-PE PI-Spring terminal blocks

Ground - 6 mm 0.236 in spacing



1SNK16206800014

ZK4-PE

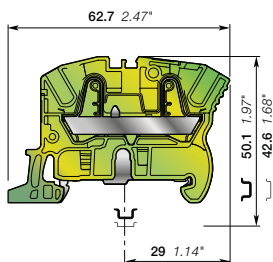

6 mm 0.236 in spacing

Description

Improve the safety of your installation in the event of a short-circuit thanks to our screwless rail contact:

- Rail contact non operator dependent,
- Performances above the requirements of the IEC 60947-7-2 terminal block standard,
- Secured snap on or off the rail,
- Profile aligned with ZK4.

Ordering details

Description	Color	Type	Part Number	Pkg qty	Weight (1 pce) g
Ground 2 connections	Green-yellow	ZK4-PE	1SNK706150R0000	20	12.60

Main technical data

Connecting capacity	IEC	UL - CSA	Mounting instructions		
1 conductor per clamp	Rigid: Solid/Stranded	0.5 ... 6 mm ²	26 ... 10 AWG	Rail	TH 35-7.5, TH 35-15
	Flexible without ferrule	0.5 ... 4 mm ²	26 ... 12 AWG	Wire stripping length	12.5 mm 0.492 in
	Flexible with non insulated ferrule	0.5 ... 4 mm ²	26 ... 12 AWG	Tool (for flexible conductor without ferrule)	Flat screwdriver Ø 3.5 mm Ø 0.138 in
	Flexible with insulated ferrule	0.5 ... 4 mm ²	26 ... 12 AWG		
Rated cross section		4 mm ²	10 AWG		
Rated short-time withstand current (1s)		480 A	636 A		
Protection		IP20	NEMA 1		
Explosive atmosphere classification		IM2 II 2 GD Ex eb I/IC/IIIC - Class I, Zone 1, AEx e II, Ex e II U			

The connecting capacity data for one Rigid: Solid/Stranded, or one Flexible conductor (when applicable) is a mandatory information required by IEC, UL and CSA standards (Copper conductors). All other data are provided as supplementary information only. For more details, please consult our CB, UL or CSA certificates and technical datasheet available on <http://www.TE.com>



Accessories

Description	Color	Type	Part Number	Pkg qty	Weight (1 pce) g
1 End stops	Dark grey	BAZ1	1SNK900002R0000	50	5.30
2 End sections	Dark grey	EK2.5	1SNK705910R0000	20	1.80
3 Circuit separators	Dark grey	CS-R2	1SNK900106R0000	20	3.80
4 Terminal block markers	White	MG-CPM 13 41791	1SNB041791R0612	1680	0.27
		MC612	1SNK150000R0000	22	10.00
		MC612PA	1SNK159999R0000	20	11.00
Universal wire markers holder	Grey	UMH	1SNK900611R0000	10	0.20

Complete list of accessories is indicated in the terminal block datasheet including end stops. Some accessories such as jumper bars may modify the terminal block's ratings. Complete information available in the accessories section of the catalog.

Technical data valid for copper conductors only.

ZK4-PE-3P PI-Spring terminal blocks

Ground with 3 connections - 6 mm 0.236 in spacing



ZK4-PE-3P

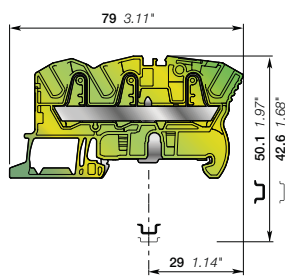

6 mm 0.236 in spacing

Description

Improve the safety of your installation in the event of a short-circuit thanks to our screwless rail contact:

- Rail contact non operator dependent,
- Performances above the requirements of the IEC 60947-7-2 terminal block standard,
- Secured snap on or off the rail,
- Profile aligned with ZK4-3P.

Ordering details

Description	Color	Type	Part Number	Pkg qty	Weight (1 pce) g
Ground 3 connections	Green-yellow	ZK4-PE-3P	1SNK706151R0000	20	15.70

Main technical data

Connecting capacity		IEC	UL - CSA	Rail	TH 35-7.5, TH 35-15
1 conductor per clamp	Rigid: Solid/Stranded	0.5 ... 6 mm ²	26 ... 10 AWG	Wire stripping length	12.5 mm 0.492 in
	Flexible without ferrule	0.5 ... 4 mm ²	26 ... 12 AWG		
	Flexible with non insulated ferrule	0.5 ... 4 mm ²	26 ... 12 AWG		
	Flexible with insulated ferrule	0.5 ... 4 mm ²	26 ... 12 AWG		
Rated cross section		4 mm ²	10 AWG	Tool (for flexible conductor without ferrule)	Flat screwdriver Ø 3.5 mm Ø 0.138 in
Rated short-time withstand current (1s)		480 A	636 A		
Protection		IP20	NEMA 1		
Explosive atmosphere classification		IM2 II 2 GD Ex eb I/IC/IIIC - Class I, Zone 1, AEx e II, Ex e II U			

The connecting capacity data for one Rigid: Solid/Stranded, or one Flexible conductor (when applicable) is a mandatory information required by IEC, UL and CSA standards (Copper conductors). All other data are provided as supplementary information only. For more details, please consult our CB, UL or CSA certificates and technical datasheet available on <http://www.TE.com>

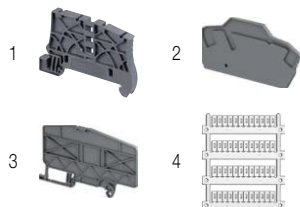

Accessories

Description	Color	Type	Part Number	Pkg qty	Weight (1 pce) g
1 End stops	Dark grey	BAZ1	1SNK900002R0000	50	5.30
2 End sections	Dark grey	EK2.5-3P	1SNK705911R0000	20	2.40
3 Circuit separators	Dark grey	CS-R3	1SNK900107R0000	20	6.40
4 Terminal block markers	White	MG-CPM 13 41791	1SNB041791R0612	1680	0.27
		MC612	1SNK150000R0000	22	10.00
		MC612PA	1SNK159999R0000	20	11.00
Universal wire markers holder	Grey	UMH	1SNK900611R0000	10	0.20

Complete list of accessories is indicated in the terminal block datasheet including end stops.

Some accessories such as jumper bars may modify the terminal block's ratings: Complete information available in the accessories section of the catalog.

Technical data valid for copper conductors only.

ZK4-PE-4P PI-Spring terminal blocks

Ground with 4 connections - 6 mm 0.236 in spacing



ZK4-PE-4P

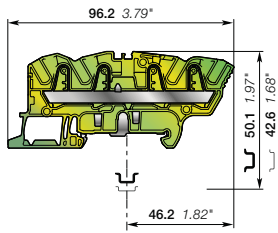

6 mm 0.236 in spacing

Description

Improve the safety of your installation in the event of a short-circuit thanks to our screwless rail contact:

- Rail contact non operator dependent,
- Performances above the requirements of the IEC 60947-7-2 terminal block standard,
- Secured snap on or off the rail,
- Profile aligned with ZK4-4P.

Ordering details

Description	Color	Type	Part Number	Pkg qty	Weight (1 pce) g
Ground 4 connections	Green-yellow	ZK4-PE-4P	1SNK706152R0000	20	18.40

Main technical data

Connecting capacity	IEC	UL - CSA	Mounting instructions		
1 conductor per clamp	Rigid: Solid/Stranded	0.5 ... 6 mm ²	26 ... 10 AWG	Rail	TH 35-7.5, TH 35-15
	Flexible without ferrule	0.5 ... 4 mm ²	26 ... 12 AWG	Wire stripping length	12.5 mm 0.492 in
	Flexible with non insulated ferrule	0.5 ... 4 mm ²	26 ... 12 AWG	Tool (for flexible conductor without ferrule)	Flat screwdriver Ø 3.5 mm Ø 0.138 in
	Flexible with insulated ferrule	0.5 ... 4 mm ²	26 ... 12 AWG		
Rated cross section		4 mm ²	10 AWG		
Rated short-time withstand current (1s)		480 A	636 A		
Protection		IP20	NEMA 1		
Explosive atmosphere classification		IM2 II 2 GD Ex eb I/II/C - Class I, Zone 1, AEx e II, Ex e II U			

The connecting capacity data for one Rigid: Solid/Stranded, or one Flexible conductor (when applicable) is a mandatory information required by IEC, UL and CSA standards (Copper conductors). All other data are provided as supplementary information only. For more details, please consult our CB, UL or CSA certificates and technical datasheet available on <http://www.TE.com>

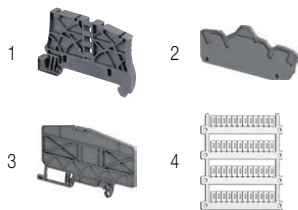

Accessories

Description	Color	Type	Part Number	Pkg qty	Weight (1 pce) g
1 End stops	Dark grey	BAZ1	1SNK900002R0000	50	5.30
2 End sections	Dark grey	EK2.5-4P	1SNK705912R0000	20	2.70
3 Circuit separators	Dark grey	CS-R3	1SNK900107R0000	20	6.40
4 Terminal block markers	White	MG-CPM 13 41791	1SNB041791R0612	1680	0.27
		MC612	1SNK150000R0000	22	10.00
		MC612PA	1SNK159999R0000	20	11.00
Universal wire markers holder	Grey	UMH	1SNK900611R0000	10	0.20

Complete list of accessories is indicated in the terminal block datasheet including end stops. Some accessories such as jumper bars may modify the terminal block's ratings. Complete information available in the accessories section of the catalog.

Technical data valid for copper conductors only.

ZK6-PE PI-Spring terminal blocks

Ground - 8 mm 0.315 in spacing



ZK6-PE

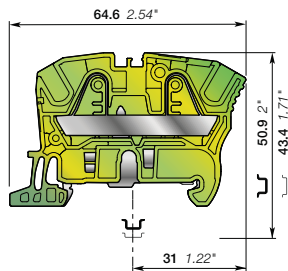

8 mm 0.315 in spacing

Description

Improve the safety of your installation in the event of a short-circuit thanks to our screwless rail contact:

- Rail contact non operator dependent,
- Performances above the requirements of the IEC 60947-7-2 terminal block standard,
- Secured snap on or off the rail,
- Profile aligned with ZK6.

Ordering details

Description	Color	Type	Part Number	Pkg qty	Weight (1 pce) g
Ground 2 connections	Green-yellow	ZK6-PE	1SNK708150R0000	20	20.30

Main technical data

Connecting capacity	IEC	UL - CSA	Rail	Wire stripping length	Tool (for flexible conductor without ferrule)
1 conductor per clamp	Rigid: Solid/Stranded	0.5 ... 10 mm²	24 ... 8 AWG	12.5 mm 0.492 in	Flat screwdriver Ø 3.5 mm Ø 0.138 in
	Flexible without ferrule	0.5 ... 6 mm²	24 ... 10 AWG		
	Flexible with non insulated ferrule	0.5 ... 6 mm²	24 ... 10 AWG		
	Flexible with insulated ferrule	0.5 ... 6 mm²	24 ... 10 AWG		
Rated cross section	6 mm²	8 AWG			
Rated short-time withstand current (1s)	720 A	1008 A			
Protection	IP20	NEMA 1			
Explosive atmosphere classification	IM2 II 2 GD Ex eb I/IC/IIIC - Class I, Zone 1, AEx e II, Ex e II U				

The connecting capacity data for one Rigid: Solid/Stranded, or one Flexible conductor (when applicable) is a mandatory information required by IEC, UL and CSA standards (Copper conductors). All other data are provided as supplementary information only. For more details, please consult our CB, UL or CSA certificates and technical datasheet available on <http://www.TE.com>

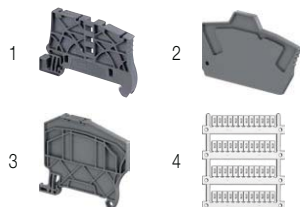

Accessories

Description	Color	Type	Part Number	Pkg qty	Weight (1 pce) g
1 End stops	Dark grey	BAZ1	1SNK900002R0000	50	5.30
2 End sections	Dark grey	EK2.5	1SNK705910R0000	20	1.80
3 Circuit separators	Dark grey	CS-R2	1SNK900106R0000	20	3.80
4 Terminal block markers	White	MG-CPM 13 41791	1SNB041791R0612	1680	0.27
		MC812	1SNK160000R0000	22	10.00
		MC812PA	1SNK169999R0000	20	14.00
Universal wire markers holder	Grey	UMH	1SNK900611R0000	10	0.20

Complete list of accessories is indicated in the terminal block datasheet including end stops.

Some accessories such as jumper bars may modify the terminal block's ratings: Complete information available in the accessories section of the catalog.

Technical data valid for copper conductors only.

ZK6-PE-3P PI-Spring terminal blocks

Ground with 3 connections - 8 mm 0.315 in spacing



1SNK162026V0014

ZK6-PE-3P

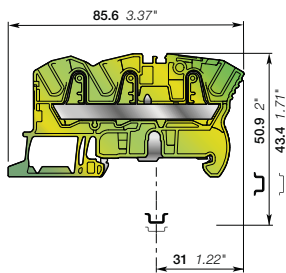

8 mm 0.315 in spacing

Description

Improve the safety of your installation in the event of a short-circuit thanks to our screwless rail contact:

- Rail contact non operator dependent,
- Performances above the requirements of the IEC 60947-7-2 terminal block standard,
- Secured snap on or off the rail,
- Profile aligned with ZK6-3P.

Ordering details

Description	Color	Type	Part Number	Pkg qty	Weight (1 pce) g
Ground 3 connections	Green-yellow	ZK6-PE-3P	1SNK708151R0000	20	21.50

Main technical data

Connecting capacity	IEC	UL - CSA	Mounting instructions		
1 conductor per clamp	Rigid: Solid/Stranded	0.5 ... 10 mm ²	24 ... 8 AWG	Rail	TH 35-7.5, TH 35-15
	Flexible without ferrule	0.5 ... 6 mm ²	24 ... 8 AWG	Wire stripping length	12.5 mm 0.492 in
	Flexible with non insulated ferrule	0.5 ... 6 mm ²	24 ... 10 AWG	Tool (for flexible conductor without ferrule)	Flat screwdriver Ø 3.5 mm Ø 0.138 in
	Flexible with insulated ferrule	0.5 ... 6 mm ²	24 ... 10 AWG		
Rated cross section		6 mm ²	8 AWG		
Rated short-time withstand current (1s)		720 A	1008 A		
Protection		IP20	NEMA 1		
Explosive atmosphere classification		IM2 II 2 GD Ex eb I/II C - Class I, Zone 1, AEx e II, Ex e II U			

The connecting capacity data for one Rigid: Solid/Stranded, or one Flexible conductor (when applicable) is a mandatory information required by IEC, UL and CSA standards (Copper conductors). All other data are provided as supplementary information only. For more details, please consult our CB, UL or CSA certificates and technical datasheet available on <http://www.TE.com>

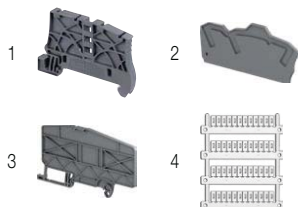
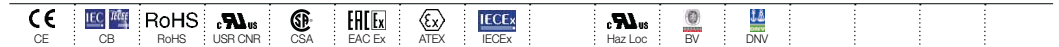

Accessories

Description	Color	Type	Part Number	Pkg qty	Weight (1 pce) g
1 End stops	Dark grey	BAZ1	1SNK900002R0000	50	5.30
2 End sections	Dark grey	EK6-3P	1SNK708911R0000	20	2.80
3 Circuit separators	Dark grey	CS-R3	1SNK900107R0000	20	6.40
4 Terminal block markers	White	MG-CPM 13 41791	1SNB041791R0612	1680	0.27
		MC812	1SNK160000R0000	22	10.00
		MC812PA	1SNK169999R0000	20	14.00
Universal wire markers holder	Grey	UMH	1SNK900611R0000	10	0.20

Complete list of accessories is indicated in the terminal block datasheet including end stops. Some accessories such as jumper bars may modify the terminal block's ratings. Complete information available in the accessories section of the catalog.

Technical data valid for copper conductors only.

ZK10-PE PI-Spring terminal blocks

Ground - 10 mm 0.394 in spacing



ZK10-PE

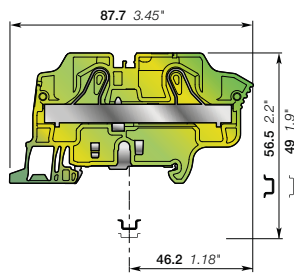

10 mm 0.394 in spacing

Description

Improve the safety of your installation in the event of a short-circuit thanks to our screwless rail contact:

- Rail contact non operator dependent,
- Performances above the requirements of the IEC 60947-7-2 terminal block standard,
- Secured snap on or off the rail,
- Profile aligned with ZK10.

Ordering details

Description	Color	Type	Part Number	Pkg qty	Weight (1 pce) g
Ground 2 connections	Green-yellow	ZK10-PE	1SNK710150R0000	20	36.20

Main technical data

Connecting capacity		IEC	UL - CSA	Mounting instructions	
1 conductor per clamp	Rigid: Solid/Stranded	0.5 ... 16 mm ²	20 ... 6 AWG	Rail	TH 35-7.5, TH 35-15
	Flexible without ferrule	0.5 ... 10 mm ²	20 ... 8 AWG	Wire stripping length	15 mm 0.591 in
	Flexible with non insulated ferrule	0.5 ... 10 mm ²	20 ... 8 AWG		
	Flexible with insulated ferrule	0.5 ... 10 mm ²	20 ... 8 AWG	Tool (for flexible conductor without ferrule)	Flat screwdriver Ø 4 mm Ø 0.157 in
Rated cross section		10 mm ²	6 AWG		
Rated short-time withstand current (1s)		1200 A	1596 A		
Protection		IP20	NEMA 1		
Explosive atmosphere classification		IM2 II 2 GD Ex eb I/IC/IIIC - Class I, Zone 1, AEx e II, Ex e II U			

The connecting capacity data for one Rigid: Solid/Stranded, or one Flexible conductor (when applicable) is a mandatory information required by IEC, UL and CSA standards (Copper conductors). All other data are provided as supplementary information only. For more details, please consult our CB, UL or CSA certificates and technical datasheet available on <http://www.TE.com>



Accessories

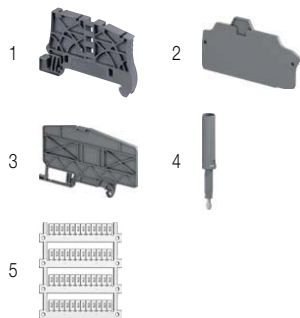

Description	Color	Type	Part Number	Pkg qty	Weight (1 pce) g
1 End stops	Dark grey	BAZ1	1SNK900002R0000	50	5.30
2 End sections	Dark grey	EK10	1SNK710910R0000	20	3.30
3 Circuit separators	Dark grey	CS-R3	1SNK900107R0000	20	6.40
4 Test adapters	Dark grey	TP2	1SNK900203R0000	20	1.70
		TP4	1SNK900205R0000	20	2.40
5 Terminal block markers	White	MG-CPM 13 41791	1SNB041791R0612	1680	0.27
		MC812	1SNK160000R0000	22	10.00
		MC812PA	1SNK169999R0000	20	14.00
	Universal wire markers holder	Grey	UMH	1SNK900611R0000	10

Complete list of accessories is indicated in the terminal block datasheet including end stops. Some accessories such as jumper bars may modify the terminal block's ratings: Complete information available in the accessories section of the catalog.

Technical data valid for copper conductors only.

ZK10-PE-3P PI-Spring terminal blocks

Ground with 3 connections - 10 mm 0.394 in spacing



ZK10-PE-3P

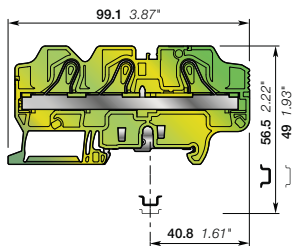

10 mm 0.394 in spacing

Description

Improve the safety of your installation in the event of a short-circuit thanks to our screwless rail contact:

- Rail contact non operator dependent,
- Performances above the requirements of the IEC 60947-7-2 standard,
- Secured snap on or off the rail,
- Profile aligned with ZK10-3P.

Ordering details

Description	Color	Type	Part Number	Pkg qty	Weight (1 pce) g
Ground 3 connections	Green-yellow	ZK10-PE-3P	1SNK710151R0000	20	43.3

Main technical data

Connecting capacity	IEC	UL - CSA	Rail	Wire stripping length	Tool (for flexible conductor without ferrule)
1 conductor per clamp	Rigid: Solid/Stranded	0.5 ... 16 mm ²	20 ... 6 AWG	 TH 35-7.5, TH 35-15 15 mm 0.591 in	 Flat screwdriver Ø 4 mm Ø 0.157 in
	Flexible without ferrule	0.5 ... 10 mm ²	20 ... 6 AWG		
	Flexible with non insulated ferrule	0.5 ... 10 mm ²	20 ... 8 AWG		
	Flexible with insulated ferrule	0.5 ... 10 mm ²	20 ... 8 AWG		
Rated cross section	10 mm ²	6 AWG			
Rated short-time withstand current (1s)	1200 A	1596 A			
Protection	IP20	NEMA 1			
Explosive atmosphere classification	IM2 II 2 GD Ex eb I/II/III C				

The connecting capacity data for one Rigid: Solid/Stranded, or one Flexible conductor (when applicable) is a mandatory information required by IEC, UL and CSA standards (Copper conductors). All other data are provided as supplementary information only. For more details, please consult our CB, UL or CSA certificates and technical datasheet available on <http://www.TE.com>

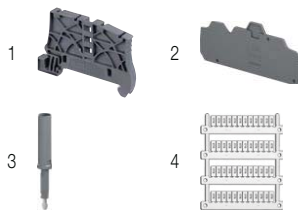

Accessories

Description	Color	Type	Part Number	Pkg qty	Weight (1 pce) g
1 End stops	Dark grey	BAZ1	1SNK900002R0000	50	5.30
2 End sections	Dark grey	EK10-3P	1SNK710911R0000	20	4.5
3 Test adapters	Dark grey	TP2	1SNK900203R0000	20	1.70
		TP4	1SNK900205R0000	20	2.40
4 Terminal block markers	White	MG-CPM 13 41791	1SNB041791R0612	1680	0.27
		MC812	1SNK160000R0000	22	10.00
		MC812PA	1SNK169999R0000	20	14.00
	Universal wire markers holder	Grey	UMH	1SNK900611R0000	10

Complete list of accessories is indicated in the terminal block datasheet including end stops.

Some accessories such as jumper bars may modify the terminal block's ratings: Complete information available in the accessories section of the catalog.

Technical data valid for copper conductors only.

ZK16-PE PI-Spring terminal blocks

Ground - 12 mm 0.472 in spacing



16 mm²
4 AWG



1SNK16208AV0014

ZK16-PE

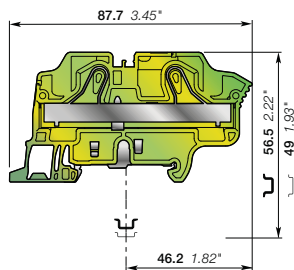

12 mm 0.472 in spacing

Description

Improve the safety of your installation in the event of a short-circuit thanks to our screwless rail contact:

- Rail contact non operator dependent,
- Performances above the requirements of the IEC 60947-7-2 terminal block standard,
- Secured snap on or off the rail,
- Profile aligned with ZK16.

Ordering details

Description	Color	Type	Part Number	Pkg qty	Weight (1 pce) g
Ground 2 connections	Green-yellow	ZK16-PE	1SNK712150R0000	20	47.00

Main technical data

Connecting capacity		IEC	UL - CSA	Mounting instructions	
1 conductor per clamp	Rigid: Solid/Stranded	0.5 ... 25 mm ²	20 ... 4 AWG	Rail	TH 35-7.5, TH 35-15
	Flexible without ferrule	0.5 ... 16 mm ²	20 ... 6 AWG	Wire stripping length	15 mm 0.591 in
	Flexible with non insulated ferrule	0.5 ... 16 mm ²	20 ... 6 AWG		
	Flexible with insulated ferrule	0.5 ... 16 mm ²	20 ... 6 AWG	Tool (for flexible conductor without ferrule)	Flat screwdriver Ø 4 mm Ø 0.157 in
Rated cross section		16 mm ²	4 AWG		
Rated short-time withstand current (1s)		1920 A	2544 A		
Protection		IP20	NEMA 1		
Explosive atmosphere classification		IM2 II 2 GD Ex eb I/IC/IIIC - Class I, Zone 1, AEx e II, Ex e II U			

The connecting capacity data for one Rigid: Solid/Stranded, or one Flexible conductor (when applicable) is a mandatory information required by IEC, UL and CSA standards (Copper conductors). All other data are provided as supplementary information only. For more details, please consult our CB, UL or CSA certificates and technical datasheet available on <http://www.TE.com>



Accessories

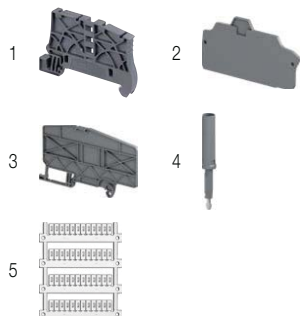

Description	Color	Type	Part Number	Pkg qty	Weight (1 pce) g
1 End stops	Dark grey	BAZ1	1SNK900002R0000	50	5.30
2 End sections	Dark grey	EK10	1SNK710910R0000	20	3.30
3 Circuit separators	Dark grey	CS-R3	1SNK900107R0000	20	6.40
4 Test adapters	Dark grey	TP2	1SNK900203R0000	20	1.70
		TP4	1SNK900205R0000	20	2.40
5 Terminal block markers	White	MG-CPM 13 41791	1SNB041791R0612	1680	0.27
		MC812	1SNK160000R0000	22	10.00
		MC812PA	1SNK169999R0000	20	14.00
		Universal wire markers holder	Grey	UMH	1SNK900611R0000

Complete list of accessories is indicated in the terminal block datasheet including end stops. Some accessories such as jumper bars may modify the terminal block's ratings: Complete information available in the accessories section of the catalog.

Technical data valid for copper conductors only.

ZK16-PE-3P PI-Spring terminal blocks

Ground with 3 connections - 12 mm 0.472 in spacing



ZK16-PE-3P

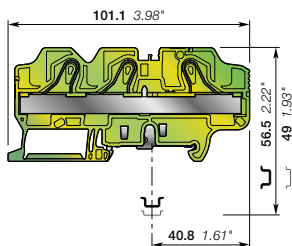

12 mm 0.472 in spacing

Description

Improve the safety of your installation in the event of a short-circuit thanks to our screwless rail contact:

- Rail contact non operator dependent,
- Performances above the requirements of the IEC 60947-7-2 standard,
- Secured snap on or off the rail,
- Profile aligned with ZK16-3P.

Ordering details

Description	Color	Type	Part Number	Pkg qty	Weight (1 pce) g
Ground 3 connections	Green-yellow	ZK16-PE-3P	1SNK712151R0000	20	56.65

Main technical data

Connecting capacity	IEC	UL - CSA	Rail	Wire stripping length	Tool (for flexible conductor without ferrule)
1 conductor per clamp	Rigid: Solid/Stranded	0.5 ... 25 mm ²	20 ... 4 AWG		
	Flexible without ferrule	0.5 ... 16 mm ²	20 ... 6 AWG		
	Flexible with non insulated ferrule	0.5 ... 16 mm ²	20 ... 6 AWG		
	Flexible with insulated ferrule	0.5 ... 16 mm ²	20 ... 6 AWG		
Rated cross section	16 mm ²	4 AWG			
Rated short-time withstand current (1s)	1920 A	2544 A			
Protection	IP20	NEMA 1			
Explosive atmosphere classification	IM2 II 2 GD Ex eb I/II/III C				

The connecting capacity data for one Rigid: Solid/Stranded, or one Flexible conductor (when applicable) is a mandatory information required by IEC, UL and CSA standards (Copper conductors). All other data are provided as supplementary information only. For more details, please consult our CB, UL or CSA certificates and technical datasheet available on <http://www.TE.com>



Accessories

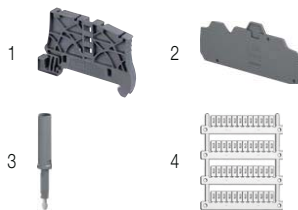

Description	Color	Type	Part Number	Pkg qty	Weight (1 pce) g
1 End stops	Dark grey	BAZ1	1SNK900002R0000	50	5.30
2 End sections	Dark grey	EK10-3P	1SNK710911R0000	20	4.5
3 Test adapters	Dark grey	TP2	1SNK900203R0000	20	1.70
		TP4	1SNK900205R0000	20	2.40
4 Terminal block markers	White	MG-CPM 13 41791	1SNB041791R0612	1680	0.27
		MC812	1SNK160000R0000	22	10.00
		MC812PA	1SNK169999R0000	20	14.00
	Universal wire markers holder	Grey	UMH	1SNK900611R0000	10

Complete list of accessories is indicated in the terminal block datasheet including end stops.

Some accessories such as jumper bars may modify the terminal block's ratings: Complete information available in the accessories section of the catalog.

Technical data valid for copper conductors only.

ZK2.5-S PI-Spring terminal blocks

Disconnect with blade - with test sockets - 5.2 mm 0.205 in spacing

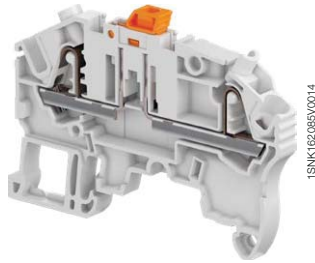

ZK2.5-S

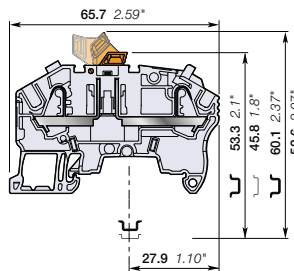

5.2 mm 0.205 in spacing

Description

Combine high performance with compact dimensions: 630 V IEC 300 V UL.

Secure the current measurement:

- for currents below 50 mA, thanks to 2 built in test points DIA 2 mm 0.079 in,
- for currents up to 16 A, by using the TP4 test adapter inserted into the jumper channels.

Ordering details

Description	Color	Type	Part Number	Pkg qty	Weight (1 pce) g
Disconnect with 2 test sockets DIA 2 mm 0.079 in	Grey	ZK2.5-S	1SNK705310R0000	50	8.10
	Blue	ZK2.5-S-BL	1SNK705320R0000	50	8.10
	Orange	ZK2.5-S-OR	1SNK705330R0000	50	8.10

Main technical data

Connecting capacity		IEC	UL - CSA	Mounting instructions	
1 conductor per clamp	Rigid: Solid/Stranded	0.2 ... 4 mm²	26 ... 12 AWG	Rail	TH 35-7.5, TH 35-15
	Flexible without ferrule	0.22 ... 2.5 mm²		Wire stripping length	11 mm 0.433 in
	Flexible with non insulated ferrule	0.22 ... 2.5 mm²	26 ... 14 AWG		
	Flexible with insulated ferrule	0.22 ... 2.5 mm²	26 ... 14 AWG		
2 conductors per clamp	Flexible with twin ferrule	0.22 ... 0.5 mm²	26 ... 20 AWG	Tool (for flexible conductor without ferrule)	Flat screwdriver Ø 3.5 mm Ø 0.138 in
	Rated current / Rated cross section		20 A / 2.5 mm²	20 A / 12 AWG	
Rated short-time withstand current (1s)		300 A	396 A		
Rated voltage		630 V	300 V		
Impulse withstand voltage		6000 V			
Protection		IP20	NEMA 1		

Recommendation for best usage: in horizontal assemblies, disconnect terminal blocks should be mounted with fixed foot on top (power side) so that the disconnect knife does not partially close through gravity. Furthermore, as specified per IEC 60947-7-1, disconnect terminal blocks are intended to be used for temporary disconnection at zero potential and at no load.

The connecting capacity data for one Rigid: Solid/Stranded, or one Flexible conductor (when applicable) is a mandatory information required by IEC, UL and CSA standards (Copper conductors). All other data are provided as supplementary information only. For more details, please consult our CB, UL or CSA certificates and technical datasheet available on <http://www.TE.com>

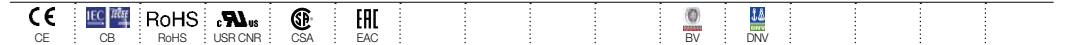

Accessories

Description	Color	Type	Part Number	Pkg qty	Weight (1 pce) g	
1 End stops	Dark grey	BAZ1	1SNK900002R0000	50	5.30	
2 End sections	Dark grey	EK2.5-3P	1SNK705911R0000	20	2.40	
3 Jumper bars	Orange	2 poles 32 A (IEC)	JB5-2	1SNK905302R0000	50	1.30
		3 poles 32 A (IEC)	JB5-3	1SNK905303R0000	50	2.00
		4 poles 32 A (IEC)	JB5-4	1SNK905304R0000	50	2.70
		5 poles 32 A (IEC)	JB5-5	1SNK905305R0000	50	3.50
		10 poles 32 A (IEC)	JB5-10	1SNK905310R0000	30	7.10
		50 poles 32 A (IEC)	JB5-50	1SNK905350R0000	10	36.00
4 Circuit separators	Dark grey	CS-R3	1SNK900107R0000	20	6.40	
5 Test adapters	Dark grey	For test plugs DIA 2 mm 0.079 in	TP2	1SNK900203R0000	20	1.70
		For test plugs DIA 4 mm 0.157 in	TP4	1SNK900205R0000	20	2.40
6 Test connectors	Dark grey	5.2 mm 0.205 in spacing	TC5	1SNK900200R0000	10	5.20
		End module, 5.2 mm 0.205 in	TC5-R1	1SNK900201R0000	10	5.20
			SHBP	1SNK900601R0000	20	4.10
8 Terminal block markers	White	Blank marker	MG-CPM 13 41790	1960	0.23	
		Blank card	MC512	1SNK140000R0000	22	9.00
			MC512PA	1SNK149999R0000	20	10.00
		Universal wire markers holder	Grey	UMH	1SNK900611R0000	10

Complete list of accessories is indicated in the terminal block datasheet including end stops.

Some accessories such as jumper bars may modify the terminal block's ratings: Complete information available in the accessories section of the catalog.

Technical data valid for copper conductors only.

ZK2.5-S-4P PI-Spring terminal blocks

Disconnect with blade - with test socket - 5.2 mm 0.205 in spacing



ZK2.5-S-4P

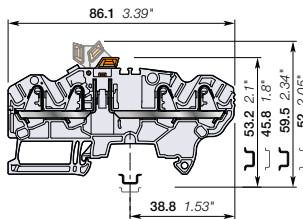

5.2 mm 0.205 in spacing

Description

- Combine high performances with compact dimensions: 630 V IEC 300 V UL,
- Simplify the measurement with 1 built in test point DIA 2 mm 0.079 in (for current below 50mA) and TP... test adapter inserted into one jumper channel,
- Clear marking visibility with SNK top marking location 20% enlarged.

Ordering details

Description	Color	Type	Part Number	Pkg qty	Weight (1 pce) g
Disconnect with 1 test socket DIA 2 mm 0.079 in	Grey	ZK2.5-S-4P	1SNK705312R0000	50	11.14
	Blue	ZK2.5-S-4P-BL	1SNK705321R0000	50	11.14
	Orange	ZK2.5-S-4P-OR	1SNK705331R0000	50	11.14

Main technical data

Connecting capacity	IEC	UL - CSA	Mounting instructions
1 conductor per clamp	Rigid: Solid/Stranded	0.2 ... 4 mm²	26 ... 12 AWG
	Flexible without ferrule	0.22 ... 2.5 mm²	26 ... 12 AWG
	Flexible with non insulated ferrule	0.22 ... 2.5 mm²	26 ... 14 AWG
	Flexible with insulated ferrule	0.22 ... 2.5 mm²	26 ... 14 AWG
2 conductors per clamp	Flexible with twin ferrule	0.22 ... 0.5 mm²	26 ... 20 AWG
Rated current / Rated cross section		20 A / 2.5 mm²	20 A / 12 AWG
Rated short-time withstand current (1s)		300 A	
Short Circuit Current Rating (with specific conditions)			
Rated voltage		630 V	300 V
Impulse withstand voltage		6000 V	
Protection		IP20	NEMA 1

Recommendation for best usage: in horizontal assemblies, disconnect terminal blocks should be mounted with fixed foot on top (power side) so that the disconnect knife does not partially close through gravity. Furthermore, as specified per IEC 60947-7-1, disconnect terminal blocks are intended to be used for temporary disconnection at zero potential and at no load.

The connecting capacity data for one Rigid: Solid/Stranded, or one Flexible conductor (when applicable) is a mandatory information required by IEC, UL and CSA standards (Copper conductors). All other data are provided as supplementary information only. For more details, please consult our CB, UL or CSA certificates and technical datasheet available on <http://www.TE.com>

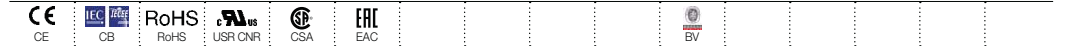

Accessories

Description	Color	Type	Part Number	Pkg qty	Weight (1 pce) g	
1 End stops	Dark grey	BAZ1	1SNK900002R0000	50	5.30	
2 End sections	Dark grey	EK2.5-S-4P	1SNK705913R0000	20	2.94	
3 Jumper bars	Orange	2 poles	JB5-2	1SNK905302R0000	50	1.30
		3 poles	JB5-3	1SNK905303R0000	50	2.00
		4 poles	JB5-4	1SNK905304R0000	50	2.70
		5 poles	JB5-5	1SNK905305R0000	50	3.50
		10 poles	JB5-10	1SNK905310R0000	30	7.10
50 poles	JB5-50	1SNK905350R0000	10	36.00		
4 Circuit separators	Dark grey	CS-R3	1SNK900107R0000	20	6.40	
5 Test adapters	Dark grey	For test plugs DIA 2 mm 0.079 in	TP2	1SNK900203R0000	20	1.70
		For test plugs DIA 4 mm 0.157 in	TP4	1SNK900205R0000	20	2.40
6 Test connectors	Dark grey	5.2 mm 0.205 in spacing	TC5	1SNK900200R0000	10	5.20
		End module, 5.2 mm 0.205 in	TC5-R1	1SNK900201R0000	10	5.20
7 Terminal block markers	White	Blank marker	MG-CPM 13 41790	1SNB041790R0512	1960	0.23
		Blank card	MC512	1SNK140000R0000	22	9.00
			MC512PA	1SNK149999R0000	20	10.00
		Universal wire markers holder	Grey	UMH	1SNK900611R0000	10

Complete list of accessories is indicated in the terminal block datasheet including end stops.

Some accessories such as jumper bars may modify the terminal block's ratings: Complete information available in the accessories section of the catalog.

Technical data valid for copper conductors only.

ZK2.5-S-R1 PI-Spring terminal blocks

Disconnect with blade - 6 mm 0.236 in spacing

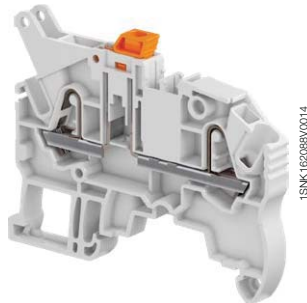

ZK2.5-S-R1

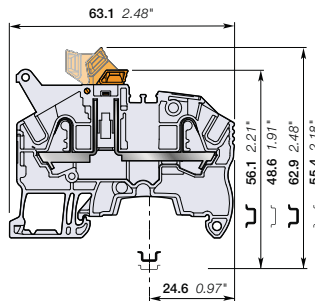

6 mm 0.236 in spacing

Description

Simplify the distribution of circuits in marshalling cabinets thanks to our disconnect terminal blocks with the same profile as ZK2.5-SF fuse.

Ordering details

Description	Color	Type	Part Number	Pkg qty	Weight (1 pce)
Disconnect Profile aligned with ZK2.5-SF	Grey <input type="checkbox"/>	ZK2.5-S-R1	1SNK706310R0000	50	8.90

Main technical data

Connecting capacity	IEC	UL - CSA	Rail	Mounting instructions	
1 conductor per clamp	Rigid: Solid/Stranded Flexible without ferrule Flexible with non insulated ferrule Flexible with insulated ferrule	0.2 ... 4 mm² 0.22 ... 2.5 mm² 0.22 ... 2.5 mm² 0.22 ... 2.5 mm²	26 ... 12 AWG 26 ... 14 AWG 26 ... 14 AWG	Wire stripping length 	TH 35-7.5, TH 35-15 11 mm 0.433 in
2 conductors per clamp	Flexible with twin ferrule	0.22 ... 0.5 mm²	26 ... 20 AWG	Tool (for flexible conductor without ferrule) 	Flat screwdriver Ø 3.5 mm Ø 0.138 in
Rated current / Rated cross section	20 A / 2.5 mm²	20 A / 12 AWG			
Rated short-time withstand current (1s)	300 A	396 A			
Rated voltage	630 V	300 V			
Impulse withstand voltage	6000 V				
Protection	IP20	NEMA 1			

Recommendation for best usage: in horizontal assemblies, disconnect terminal blocks should be mounted with fixed foot on top (power side) so that the disconnect knife does not partially close through gravity. Furthermore, as specified per IEC 60947-7-1, disconnect terminal blocks are intended to be used for temporary disconnection at zero potential and at no load.

The connecting capacity data for one Rigid: Solid/Stranded, or one Flexible conductor (when applicable) is a mandatory information required by IEC, UL and CSA standards (Copper conductors). All other data are provided as supplementary information only. For more details, please consult our CB, UL or CSA certificates and technical datasheet available on <http://www.TE.com>



Accessories

Description	Color	Type	Part Number	Pkg qty	Weight (1 pce)
1 End stops	Dark grey <input type="checkbox"/>	BAZ1	1SNK900002R0000	50	5.30
2 End sections	Dark grey <input type="checkbox"/>	EK2.5-3P	1SNK705911R0000	20	2.40
3 Jumper bars	Orange <input type="checkbox"/>	JB6-2 JB6-3 JB6-4 JB6-5 JB6-10 JB6-50	1SNK906302R0000 1SNK906303R0000 1SNK906304R0000 1SNK906305R0000 1SNK906310R0000 1SNK906350R0000	50 50 50 50 20 10	1.30 2.10 2.90 3.60 7.40 38.10
4 Circuit separators	Dark grey <input type="checkbox"/>	CS-R3	1SNK900107R0000	20	6.40
5 Test adapters	Dark grey <input type="checkbox"/>	TP2 TP4	1SNK900203R0000 1SNK900205R0000	20 20	1.70 2.40
6 Test connectors	Dark grey <input type="checkbox"/>	TC5-R1	1SNK900201R0000	10	5.20
7 Spacers	Dark grey <input type="checkbox"/>	ES-TC6	1SNK900105R0000	10	0.80
8 Terminal block markers	White <input type="checkbox"/>	MG-CPM 13 41791 MC612 MC612PA Universal wire markers holder	1SNB041791R0612 1SNK150000R0000 1SNK159999R0000 1SNK900611R0000	1680 22 20 10	0.27 10.00 11.00 0.20

Complete list of accessories is indicated in the terminal block datasheet including end stops. Some accessories such as jumper bars may modify the terminal block's ratings. Complete information available in the accessories section of the catalog.

PI-Spring terminal blocks

Description	Color	Type	Part Number	Pkg qty	Weight (1 pce)
Feed-through	Grey <input type="checkbox"/>	ZK4-3P	1SNK706011R0000	50	11.00
Fuse	Grey, dark grey <input type="checkbox"/>	ZK2.5-SF	1SNK706410R0000	50	16.20

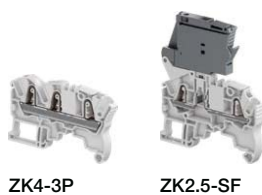
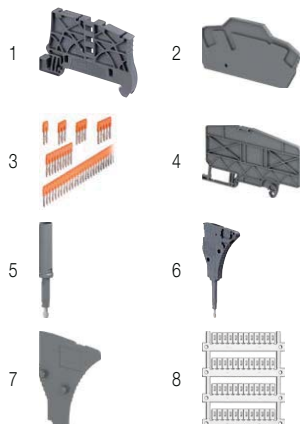

Technical data valid for copper conductors only.

ZK2.5-SP PI-Spring terminal blocks

Disconnect with plug - with test sockets - 5.2 mm 0.205 in spacing

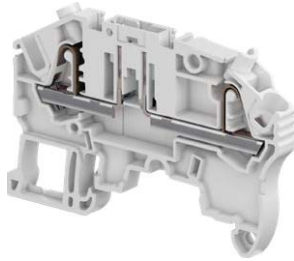

1SNK162039/0014

ZK2.5-SP

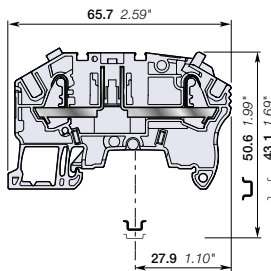

5.2 mm 0.205 in spacing

Description

The flexible solution for fitting the component of your choice in series with our quick-fitting PG5 component holder plug:
 – compatible with components of 8.8 x 3.2 mm 0.346 x 0.125 in, such as resistors, diodes or mini axial fuses.

Ordering details

Description	Color	Type	Part Number	Pkg qty	Weight (1 pce) g
Disconnect with 2 test sockets DIA 2 mm 0.079 in	Grey	ZK2.5-SP	1SNK705311R0000	50	11.50

Main technical data

Connecting capacity	IEC	UL - CSA
1 conductor per clamp	Rigid: Solid/Stranded	26 ... 12 AWG
	Flexible without ferrule	26 ... 14 AWG
	Flexible with non insulated ferrule	26 ... 14 AWG
	Flexible with insulated ferrule	26 ... 14 AWG
2 conductors per clamp	Flexible with twin ferrule	26 ... 20 AWG
Rated current / Rated cross section		17 A / 2.5 mm²
Rated short-time withstand current (1s)		300 A
Rated voltage		630 V
Impulse withstand voltage		6000 V
Protection		IP20

Mounting instructions

Rail	TH 35-7.5, TH 35-15
Wire stripping length	11 mm 0.433 in
Tool (for flexible conductor without ferrule)	Flat screwdriver Ø 3.5 mm Ø 0.138 in

The connecting capacity data for one Rigid: Solid/Stranded, or one Flexible conductor (when applicable) is a mandatory information required by IEC, UL and CSA standards (Copper conductors). All other data are provided as supplementary information only. For more details, please consult our CB, UL or CSA certificates and technical datasheet available on <http://www.TE.com>

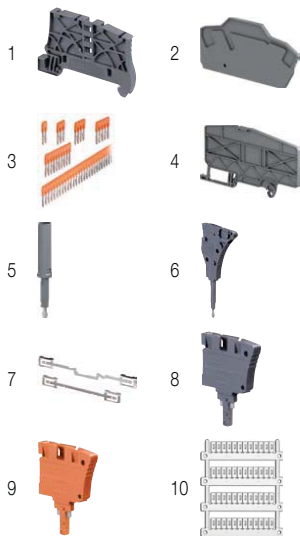
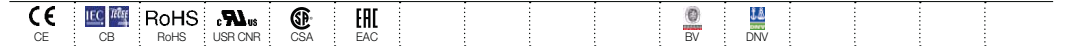

Accessories

Description	Color	Type	Part Number	Pkg qty	Weight (1 pce) g	
1 End stops	Dark grey	BAZ1	1SNK900002R0000	50	5.30	
2 End sections	Dark grey	EK2.5-3P	1SNK705911R0000	20	2.40	
3 Jumper bars	Orange	2 poles	JB5-2	1SNK905302R0000	50	1.30
		3 poles	JB5-3	1SNK905303R0000	50	2.00
		4 poles	JB5-4	1SNK905304R0000	50	2.70
		5 poles	JB5-5	1SNK905305R0000	50	3.50
		10 poles	JB5-10	1SNK905310R0000	30	7.10
		50 poles	JB5-50	1SNK905350R0000	10	36.00
4 Circuit separators	Dark grey	CS-R3	1SNK900107R0000	20	6.40	
5 Test adapters	Dark grey	For test plugs DIA 2 mm 0.079 in	TP2	1SNK900203R0000	20	1.70
		For test plugs DIA 4 mm 0.157 in	TP4	1SNK900205R0000	20	2.40
6 Test connectors	Dark grey	5.2 mm 0.205 in spacing	TC5	1SNK900200R0000	10	5.20
		End module, 5.2 mm 0.205 in	TC5-R1	1SNK900201R0000	10	5.20
7 Shield connectors		SHBP	1SNK900601R0000	20	4.10	
8 Component plugs	Dark grey	PG5	1SNK900401R0000	20	3.50	
9 Disconnect plugs	Orange	PG5-R1	1SNK900402R0000	20	3.50	
10 Terminal block markers	White	Blank marker	MG-CPM 13 41790	1SNB041790R0512	1960	0.23
		Blank card	MC512	1SNK140000R0000	22	9.00
		Universal wire markers holder	UMH	1SNK149999R0000	20	10.00
	Grey		1SNK900611R0000	10	0.20	

Complete list of accessories is indicated in the terminal block datasheet including end stops. Some accessories such as jumper bars may modify the terminal block's ratings: Complete information available in the accessories section of the catalog.

Technical data valid for copper conductors only.

ZK2.5-SP-4P PI-Spring terminal blocks

Disconnect with plug - with test socket - 5.2 mm 0.205 in spacing

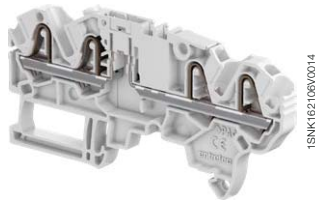

ZK2.5-SP-4P

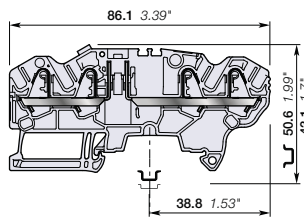

5.2 mm 0.205 in spacing

Description

The flexible solution for fitting the component of your choice in series with our quick-fitting PG5 component holder plug:

- compatible with components of 8.8 x 3.2 mm 0.346 x 0.125 in, such as resistors, diodes or mini axial fuses.

Ordering details

Description	Color	Type	Part Number	Pkg qty	Weight (1 pce) g
Disconnect with 1 test socket DIA 2 mm 0.079 in	Grey <input type="checkbox"/>	ZK2.5-SP-4P	1SNK705313R0000	50	10.67

Main technical data

Connecting capacity		IEC	UL - CSA	Mounting instructions	
1 conductor per clamp	Rigid: Solid/Stranded	0.2 ... 4 mm ²	26 ... 12 AWG	Rail	TH 35-7.5, TH 35-15
	Flexible without ferrule	0.22 ... 2.5 mm ²	26 ... 14 AWG	Wire stripping length	11 mm 0.433 in
	Flexible with non insulated ferrule	0.22 ... 2.5 mm ²	26 ... 14 AWG		
	Flexible with insulated ferrule	0.22 ... 2.5 mm ²	26 ... 14 AWG		
2 conductors per clamp	Flexible with twin ferrule	0.22 ... 0.5 mm ²	26 ... 20 AWG	Tool (for flexible conductor without ferrule)	Flat screwdriver Ø 3.5 mm Ø 0.138 in
	Rated current / Rated cross section		17 A / 2.5 mm ²	18 A / 12 AWG	
Rated short-time withstand current (1s)		300 A			
Short Circuit Current Rating (with specific conditions)					
Rated voltage		630 V	300 V		
Impulse withstand voltage		6000 V			
Protection		IP20	NEMA 1		

The connecting capacity data for one Rigid: Solid/Stranded, or one Flexible conductor (when applicable) is a mandatory information required by IEC, UL and CSA standards (Copper conductors). All other data are provided as supplementary information only. For more details, please consult our CB, UL or CSA certificates and technical datasheet available on <http://www.TE.com>

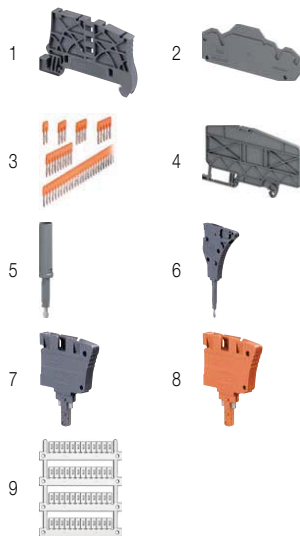
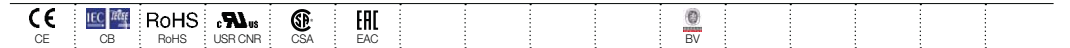

Accessories

Description	Color	Type	Part Number	Pkg qty	Weight (1 pce) g	
1 End stops	Dark grey <input type="checkbox"/>	BAZ1	1SNK900002R0000	50	5.30	
2 End sections	Dark grey <input type="checkbox"/>	EK2.5-S-4P	1SNK705913R0000	20	2.94	
3 Jumper bars	Orange <input type="checkbox"/>	2 poles	JB5-2	1SNK905302R0000	50	1.30
		3 poles	JB5-3	1SNK905303R0000	50	2.00
		4 poles	JB5-4	1SNK905304R0000	50	2.70
		5 poles	JB5-5	1SNK905305R0000	50	3.50
		10 poles	JB5-10	1SNK905310R0000	30	7.10
		50 poles	JB5-50	1SNK905350R0000	10	36.00
4 Circuit separators	Dark grey <input type="checkbox"/>	CS-R3	1SNK900107R0000	20	6.40	
5 Test adapters	Dark grey <input type="checkbox"/>	For test plugs DIA 2 mm 0.079 in	TP2	1SNK900203R0000	20	1.70
		For test plugs DIA 4 mm 0.157 in	TP4	1SNK900205R0000	20	2.40
6 Test connectors	Dark grey <input type="checkbox"/>	5.2 mm 0.205 in spacing	TC5	1SNK900200R0000	10	5.20
		End module, 5.2 mm 0.205 in	TC5-R1	1SNK900201R0000	10	5.20
7 Component plugs	Dark grey <input type="checkbox"/>	PG5	1SNK900401R0000	20	3.50	
8 Disconnect plugs	Orange <input type="checkbox"/>	PG5-R1	1SNK900402R0000	20	3.50	
9 Terminal block markers	White <input type="checkbox"/>	Blank marker	MG-CPM 13 41790	1SNB041790R0512	1960	0.23
		Blank card	MC512	1SNK140000R0000	22	9.00
	Grey <input type="checkbox"/>	MC512PA	1SNK149999R0000	20	10.00	
		Universal wire markers holder	UMH	1SNK900611R0000	10	0.20

Complete list of accessories is indicated in the terminal block datasheet including end stops.

Some accessories such as jumper bars may modify the terminal block's ratings: Complete information available in the accessories section of the catalog.

Technical data valid for copper conductors only.

ZK2.5-SF PI-Spring terminal blocks

For 5x20 fuses - 6 mm 0.236 in spacing



ZK2.5-SF

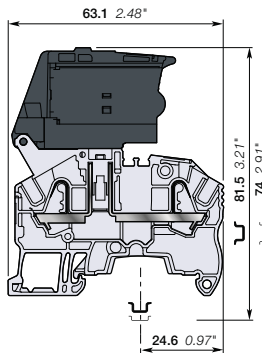

6 mm 0.236 in spacing

Description

Protect your circuits with 5x20 fuse terminal blocks compliant with IEC 60947-7-3 standard (fuse not supplied with the terminal blocks),

- Simplify the distribution thanks to the 2 jumper channels aligned with ZK4-3P feed-through and ZK2.5-S-R1 disconnect terminal blocks.

Ordering details

Description	Color	Type	Part Number	Pkg qty	Weight (1 pce)
Fuse	Grey, dark grey	ZK2.5-SF	1SNK706410R0000	50	16.20

Main technical data

Connecting capacity		IEC	UL - CSA	Mounting instructions	
1 conductor per clamp	Rigid: Solid/Stranded	0.2 ... 4 mm ²	26 ... 12 AWG	Rail	 TH 35-7.5, TH 35-15 11 mm 0.433 in
	Flexible without ferrule	0.22 ... 2.5 mm ²			
	Flexible with non insulated ferrule	0.22 ... 2.5 mm ²	26 ... 14 AWG		
	Flexible with insulated ferrule	0.22 ... 2.5 mm ²	26 ... 14 AWG		
2 conductors per clamp	Flexible with twin ferrule	0.22 ... 0.5 mm ²	26 ... 20 AWG	Tool (for flexible conductor without ferrule)	 Flat screwdriver Ø 3.5 mm Ø 0.138 in
Rated current / Rated cross section		6.3 A / 2.5 mm ²	16 A / 12 AWG		
Rated short-time withstand current (1s)			396 A		
Rated voltage		500 V	300 V		
Impulse withstand voltage		6000 V			
Protection		IP20	NEMA 1		

The fuse holder must be first disconnected prior any fuse replacement. Mount your fuse safely without touching any active part: put the fuse into the hooks of the fuse holder shutter; at the closing of the shutter, the fuse is perfectly in place in the fuse holder.

Separate arrangement		Assembly composed of 1 fuse terminal block in between non fuse terminal blocks	Overload and short-circuit protection	2.5 W
			Exclusive short-circuit protection	4 W
Compound arrangement		Assembly composed of 5 fuse terminal blocks	Overload and short-circuit protection	1.6 W
			Exclusive short-circuit protection	4 W

The connecting capacity data for one Rigid: Solid/Stranded, or one Flexible conductor (when applicable) is a mandatory information required by IEC, UL and CSA standards (Copper conductors). All other data are provided as supplementary information only. For more details, please consult our CB, UL or CSA certificates and technical datasheet available on <http://www.TE.com>



Accessories



Description	Color	Type	Part Number	Pkg qty	Weight (1 pce)	
1 End stops	Dark grey	BAZ1	1SNK900002R0000	50	5.30	
2 End sections	Dark grey	EK2 5-3P	1SNK705911R0000	20	2.40	
3 Jumper bars	Orange	2 poles	JB6-2	1SNK906302R0000	50	1.30
		3 poles	JB6-3	1SNK906303R0000	50	2.10
		4 poles	JB6-4	1SNK906304R0000	50	2.90
		5 poles	JB6-5	1SNK906305R0000	50	3.60
		10 poles	JB6-10	1SNK906310R0000	20	7.40
		50 poles	JB6-50	1SNK906350R0000	10	38.10
4 Circuit separators	Dark grey	CS-R3	1SNK900107R0000	20	6.40	
5 Test adapters	Dark grey	For test plugs DIA 2 mm 0.079 in	TP2	1SNK900203R0000	20	1.70
		For test plugs DIA 4 mm 0.157 in	TP4	1SNK900205R0000	20	2.40
6 Test connectors	Dark grey	TC5-R1	1SNK900201R0000	10	5.20	
7 Spacers	Dark grey		ES-TC6	1SNK900105R0000	10	0.80
8 Terminal block markers	White	Blank marker	MG-CPM 13 41791	1SNB041791R0612	1680	0.27
		Blank card	MC612	1SNK150000R0000	22	10.00
			MC612PA	1SNK159999R0000	20	11.00

Complete list of accessories is indicated in the terminal block datasheet including end stops. Some accessories such as jumper bars may modify the terminal block's ratings: Complete information available in the accessories section of the catalog.

Technical data valid for copper conductors only.

ZK2.5-SF-R PI-Spring terminal blocks

For 5x20 fuses - with blown fuse indicator - 6 mm 0.236 in spacing

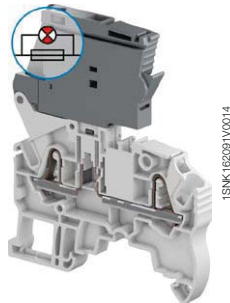

ZK2.5-SF-R

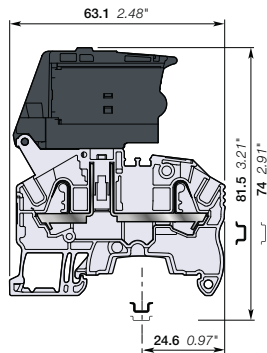

6 mm 0.236 in spacing

Description

- Protect your circuits with 5x20 fuse terminal blocks compliant with IEC 60947-7-3 standard (fuse not supplied with the terminal blocks),
- Simplify the distribution thanks to the 2 jumper channels aligned with ZK4-3P feed-through and ZK2.5-S-R1 disconnect terminal blocks,
- Quickly identify the defective circuit thanks to the blown fuse indicator (with leakage current < 0.5 mA).

Ordering details

Description	Color	Type	Part Number	Pkg qty	Weight (1 pce) g
Fuse with blown fuse indicator 24 ... 110 V AC / DC	Grey, dark grey	ZK2.5-SF-R1	1SNK706411R0000	50	16.30
with blown fuse indicator 115 ... 250 V AC / DC		ZK2.5-SF-R3	1SNK706412R0000	50	16.30

Main technical data

Connecting capacity		IEC	UL - CSA	Mounting instructions	
1 conductor per clamp	Rigid: Solid/Stranded	0.2 ... 4 mm²	26 ... 12 AWG	Rail	TH 35-7.5, TH 35-15
	Flexible without ferrule	0.22 ... 2.5 mm²		Wire stripping length	11 mm 0.433 in
	Flexible with non insulated ferrule	0.22 ... 2.5 mm²	26 ... 14 AWG	Tool (for flexible conductor without ferrule)	Flat screwdriver Ø 3.5 mm Ø 0.138 in
	Flexible with insulated ferrule	0.22 ... 2.5 mm²	26 ... 14 AWG		
2 conductors per clamp	Flexible with twin ferrule	0.22 ... 0.5 mm²	26 ... 20 AWG		
Rated current / Rated cross section		6.3 A / 2.5 mm²	16 A / 12 AWG		
Rated short-time withstand current (1s)			396 A		
Rated voltage		500 V	300 V		
Impulse withstand voltage		6000 V			
Protection		IP20	NEMA 1		

The fuse holder must be first disconnected prior any fuse replacement. Mount your fuse safely without touching any active part: put the fuse into the hooks of the fuse holder shutter; at the closing of the shutter, the fuse is perfectly in place in the fuse holder.

Separate arrangement	Compound arrangement	Protection	Power
Assembly composed of 1 fuse terminal block in between non fuse terminal blocks	Assembly composed of 5 fuse terminal blocks	Overload and short-circuit protection	2.5 W
		Exclusive short-circuit protection	4 W
		Overload and short-circuit protection	1.6 W
		Exclusive short-circuit protection	4 W

The connecting capacity data for one Rigid: Solid/Stranded, or one Flexible conductor (when applicable) is a mandatory information required by IEC, UL and CSA standards (Copper conductors). All other data are provided as supplementary information only. For more details, please consult our CB, UL or CSA certificates and technical datasheet available on <http://www.TE.com>

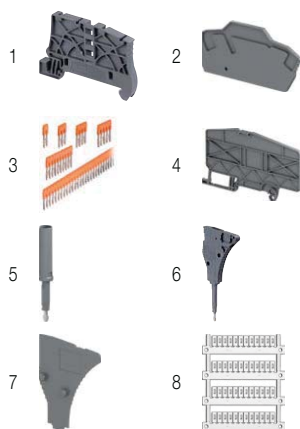
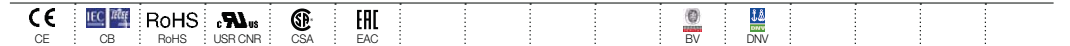

Accessories

Description	Color	Type	Part Number	Pkg qty	Weight (1 pce) g	
1 End stops	Dark grey	BAZ1	1SNK900002R0000	50	5.30	
2 End sections	Dark grey	EK2.5-3P	1SNK705911R0000	20	2.40	
3 Jumper bars	Orange	2 poles	JB6-2	1SNK906302R0000	50	1.30
		3 poles	JB6-3	1SNK906303R0000	50	2.10
		4 poles	JB6-4	1SNK906304R0000	50	2.90
		5 poles	JB6-5	1SNK906305R0000	50	3.60
		10 poles	JB6-10	1SNK906310R0000	20	7.40
		50 poles	JB6-50	1SNK906350R0000	10	38.10
4 Circuit separators	Dark grey	CS-R3	1SNK900107R0000	20	6.40	
5 Test adapters	Dark grey	For test plugs DIA 2 mm 0.079 in	TP2	1SNK900203R0000	20	1.70
		For test plugs DIA 4 mm 0.157 in	TP4	1SNK900205R0000	20	2.40
		End module, 5.2 mm 0.205 in	TC5-R1	1SNK900201R0000	10	5.20
7 Spacers	Dark grey	ES-TC6	1SNK900105R0000	10	0.80	
		MG-CPM 13 41791	1SNB041791R0612	1680	0.27	
8 Terminal block markers	White	MC612	1SNK150000R0000	22	10.00	
		MC612PA	1SNK159999R0000	20	11.00	

Complete list of accessories is indicated in the terminal block datasheet including end stops. Some accessories such as jumper bars may modify the terminal block's ratings. Complete information available in the accessories section of the catalog.

Technical data valid for copper conductors only.

ZK2.5-D2 PI-Spring terminal blocks

Double deck with 2 feed-through circuits - 5.2 mm 0.205 in spacing



ZK2.5-D2

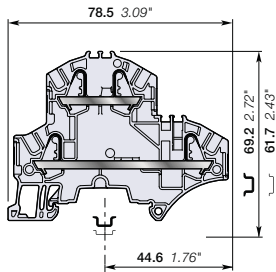

5.2 mm 0.205 in spacing

Description

Combine high performance with compact dimensions:

- 800 V IEC 600 V UL,
- 2 jumper channels and a large input and output marker zone on each deck.

Ordering details

Description	Color	Type	Part Number	Pkg qty	Weight (1 pce) g
Feed-through 2 feed-through circuits	Grey <input type="checkbox"/>	ZK2.5-D2	1SNK705210R0000	50	11.20
	Blue <input type="checkbox"/>	ZK2.5-D2-BL	1SNK705220R0000	50	11.20

Main technical data

Connecting capacity	IEC	UL - CSA	Mounting instructions
1 conductor per clamp	Rigid: Solid/Stranded	0.2 ... 4 mm ²	26 ... 12 AWG
	Flexible without ferrule	0.22 ... 2.5 mm ²	26 ... 14 AWG
	Flexible with non insulated ferrule	0.22 ... 2.5 mm ²	26 ... 14 AWG
	Flexible with insulated ferrule	0.22 ... 2.5 mm ²	26 ... 14 AWG
2 conductors per clamp	Flexible with twin ferrule	0.22 ... 0.5 mm ²	26 ... 20 AWG
Rated current / Rated cross section		24 A / 2.5 mm ²	20 A / 12 AWG
Rated short-time withstand current (1s)		300 A	396 A
Short Circuit Current Rating (with specific conditions)			100 kA
Rated voltage		800 V	600 V
Impulse withstand voltage		8000 V	
Protection		IP20	NEMA 1
Increased safety Ex e		693 V 21 A IEC/EN 60079-7 - IM2 II 2 GD Ex eb I/IC/IIIC	

The connecting capacity data for one Rigid: Solid/Stranded, or one Flexible conductor (when applicable) is a mandatory information required by IEC, UL and CSA standards (Copper conductors). All other data are provided as supplementary information only. For more details, please consult our CB, UL or CSA certificates and technical datasheet available on <http://www.TE.com>



Accessories

Description	Color	Type	Part Number	Pkg qty	Weight (1 pce) g	
1 End stops 10 mm 0.394 in	Dark grey <input type="checkbox"/>	BAZH1	1SNK900102R0000	20	24.00	
2 End sections 2 mm 0.079 in	Dark grey <input type="checkbox"/>	EK2.5-D2	1SNK705960R0000	20	3.40	
3 Jumper bars	Orange <input type="checkbox"/>	2 poles 32 A (IEC)	JB5-2	1SNK905302R0000	50	1.30
		3 poles 32 A (IEC)	JB5-3	1SNK905303R0000	50	2.00
		4 poles 32 A (IEC)	JB5-4	1SNK905304R0000	50	2.70
		5 poles 32 A (IEC)	JB5-5	1SNK905305R0000	50	3.50
		10 poles 32 A (IEC)	JB5-10	1SNK905310R0000	30	7.10
4 Test adapters	Dark grey <input type="checkbox"/>	For test plugs DIA 2 mm 0.079 in	TP2	1SNK900203R0000	20	1.70
		For test plugs DIA 4 mm 0.157 in	TP4	1SNK900205R0000	20	2.40
5 Test connectors 5.2 mm 0.205 in spacing	Dark grey <input type="checkbox"/>		TC5	1SNK900200R0000	10	5.20
		End module, 5.2 mm 0.205 in	TC5-R1	1SNK900201R0000	10	5.20
6 Shield connectors		SHB	1SNK900602R0000	20	4.90	
7 Label holders	Dark grey <input type="checkbox"/>	LH-J	1SNK900606R0000	100	0.73	
8 Terminal block markers	White <input type="checkbox"/>	Blank marker	MG-CPM 13 41790	1SNB041790R0512	1960	0.23
		Blank card	MC512	1SNK140000R0000	22	9.00
			MC512PA	1SNK149999R0000	20	10.00
	Universal wire markers holder	Grey <input type="checkbox"/>	UMH	1SNK900611R0000	10	0.20

Complete list of accessories is indicated in the terminal block datasheet including end stops. Some accessories such as jumper bars may modify the terminal block's ratings: Complete information available in the accessories section of the catalog.



Ground PI-Spring terminal blocks

Description	Color	Type	Part Number	Pkg qty	Weight (1 pce) g
Ground Profile aligned with ZK2.5-D2 and ZK2.5-D1	Green-yellow <input type="checkbox"/>	ZK2.5-D1-PE	1SNK705250R0000	20	15.70

Technical data valid for copper conductors only.

ZK2.5-D1 PI-Spring terminal blocks

Double deck with 1 feed-through circuit - 5.2 mm 0.205 in spacing



ZK2.5-D1

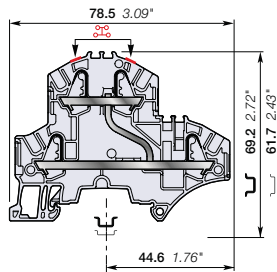

5.2 mm 0.205 in spacing

Description

– Find the same functionalities as ZK2.5-D2 and ease one potential distribution on 4 independent connections.

Ordering details

Description	Color	Type	Part Number	Pkg qty	Weight (1 pce) g
Feed-through 1 feed-through circuit	Grey	ZK2.5-D1	1SNK705211R0000	50	11.20

Main technical data

Connecting capacity		IEC	UL - CSA	Mounting instructions	
1 conductor per clamp	Rigid: Solid/Stranded	0.2 ... 4 mm ²	26 ... 12 AWG	Rail	TH 35-7.5, TH 35-15
	Flexible without ferrule	0.22 ... 2.5 mm ²		Wire stripping length	11 mm 0.433 in
	Flexible with non insulated ferrule	0.22 ... 2.5 mm ²	26 ... 14 AWG	Tool (for flexible conductor without ferrule)	Flat screwdriver Ø 3.5 mm Ø 0.138 in
	Flexible with insulated ferrule	0.22 ... 2.5 mm ²	26 ... 14 AWG		
2 conductors per clamp	Flexible with twin ferrule	0.22 ... 0.5 mm ²	26 ... 20 AWG		
Rated current / Rated cross section		24 A / 2.5 mm ²	20 A / 12 AWG		
Rated short-time withstand current (1s)		300 A	396 A		
Short Circuit Current Rating (with specific conditions)			100 kA		
Rated voltage		800 V	600 V		
Impulse withstand voltage		8000 V			
Protection		IP20	NEMA 1		
Increased safety Ex e		693 V 21 A IEC/EN 60079-7 - IM2 II 2 GD Ex eb I/II/C/III/C			

The connecting capacity data for one Rigid: Solid/Stranded, or one Flexible conductor (when applicable) is a mandatory information required by IEC, UL and CSA standards (Copper conductors). All other data are provided as supplementary information only. For more details, please consult our CB, UL or CSA certificates and technical datasheet available on <http://www.TE.com>



Accessories

Description	Color	Type	Part Number	Pkg qty	Weight (1 pce) g
1 End stops 10 mm 0.394 in	Dark grey	BAZH1	1SNK900102R0000	20	24.00
2 End sections 2 mm 0.079 in	Dark grey	EK2.5-D2	1SNK705960R0000	20	3.40
3 Jumper bars 2 poles 32 A (IEC) 3 poles 32 A (IEC) 4 poles 32 A (IEC) 5 poles 32 A (IEC) 10 poles 32 A (IEC) 50 poles 32 A (IEC)	Orange	JB5-2	1SNK905302R0000	50	1.30
		JB5-3	1SNK905303R0000	50	2.00
		JB5-4	1SNK905304R0000	50	2.70
		JB5-5	1SNK905305R0000	50	3.50
		JB5-10	1SNK905310R0000	30	7.10
		JB5-50	1SNK905350R0000	10	36.00
4 Test adapters For test plugs DIA 2 mm 0.079 in For test plugs DIA 4 mm 0.157 in	Dark grey	TP2	1SNK900203R0000	20	1.70
		TP4	1SNK900205R0000	20	2.40
5 Test connectors 5.2 mm 0.205 in spacing End module, 5.2 mm 0.205 in	Dark grey	TC5	1SNK900200R0000	10	5.20
		TC5-R1	1SNK900201R0000	10	5.20
6 Shield connectors		SHB	1SNK900602R0000	20	4.90
7 Label holders	Dark grey	LH-J	1SNK900606R0000	100	0.73
8 Terminal block markers Blank marker Blank card Universal wire markers holder	White	MG-CPM 13 41790	1SNB041790R0512	1960	0.23
		MC512	1SNK140000R0000	22	9.00
		MC512PA	1SNK149999R0000	20	10.00
	UMH	1SNK900611R0000	10	0.20	

Complete list of accessories is indicated in the terminal block datasheet including end stops. Some accessories such as jumper bars may modify the terminal block's ratings: Complete information available in the accessories section of the catalog.

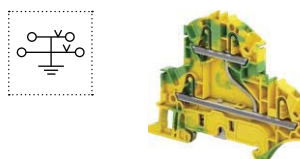

Ground PI-Spring terminal blocks

Description	Color	Type	Part Number	Pkg qty	Weight (1 pce) g
Ground Profile aligned with ZK2.5-D2 and ZK2.5-D1	Green-yellow	ZK2.5-D1-PE	1SNK705250R0000	20	15.70

Technical data valid for copper conductors only.

ZK2.5-D2-PE PI-Spring terminal blocks

Double deck with 1 feed-through circuit and 1 ground circuit - 5.2 mm 0.205 in spacing



1SNK162079N0014

ZK2.5-D2-PE

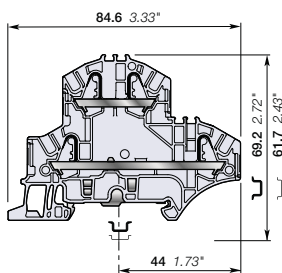

5.2 mm 0.205 in spacing

Description

Combine high performance with compact dimensions:

- 800 V IEC 600 V UL,
- 1 feed through circuit and 1 ground circuit in just 5.2 mm 0.205 in spacing,
- 2 jumper channels and a large input and output marker zone on each deck,
- designed for easy wiring.

Ordering details

Description	Color	Type	Part Number	Pkg qty	Weight (1 pce)
Feed-through + ground	Grey, Green-yellow	ZK2.5-D2-PE	1SNK705212R0000	20	15.70

Main technical data

Connecting capacity		IEC	UL - CSA	Mounting instructions	
1 conductor per clamp	Rigid: Solid/Stranded	0.2 ... 4 mm ²	26 ... 12 AWG	Rail	TH 35-7.5, TH 35-15
	Flexible without ferrule	0.22 ... 2.5 mm ²	26 ... 12 AWG	Wire stripping length	11 mm 0.433 in
	Flexible with non insulated ferrule	0.22 ... 2.5 mm ²	26 ... 14 AWG	Tool (for flexible conductor without ferrule)	Flat screwdriver Ø 3.5 mm Ø 0.138 in
	Flexible with insulated ferrule	0.22 ... 2.5 mm ²	26 ... 14 AWG		
2 conductors per clamp	Flexible with twin ferrule	0.22 ... 0.5 mm ²	26 ... 20 AWG		
Rated current / Rated cross section		24 A / 2.5 mm ²	20 A / 12 AWG		
Rated short-time withstand current (1s)		300 A	396 A		
Short Circuit Current Rating (with specific conditions)					
Rated voltage		800 V	600 V		
Impulse withstand voltage		8000 V			
Protection		IP20	NEMA 1		
Increased safety Ex e		693 V 21 A IEC/EN 60079-7 - IM2 II 2 GD Ex eb I/IC/IIIC			

The connecting capacity data for one Rigid: Solid/Stranded, or one Flexible conductor (when applicable) is a mandatory information required by IEC, UL and CSA standards (Copper conductors). All other data are provided as supplementary information only. For more details, please consult our CB, UL or CSA certificates and technical datasheet available on <http://www.TE.com>



Accessories

Description	Color	Type	Part Number	Pkg qty	Weight (1 pce)	
1 End stops	Dark grey	BAZH1	1SNK900102R0000	20	24.00	
2 End sections	Dark grey	EK2.5-D2	1SNK705960R0000	20	3.40	
3 Jumper bars	Orange	2 poles 32 A (IEC)	JB5-2	1SNK905302R0000	50	1.30
		3 poles 32 A (IEC)	JB5-3	1SNK905303R0000	50	2.00
		4 poles 32 A (IEC)	JB5-4	1SNK905304R0000	50	2.70
		5 poles 32 A (IEC)	JB5-5	1SNK905305R0000	50	3.50
		10 poles 32 A (IEC)	JB5-10	1SNK905310R0000	30	7.10
4 Test adapters	Dark grey	For test plugs DIA 2 mm 0.079 in	TP2	1SNK900203R0000	20	1.70
		For test plugs DIA 4 mm 0.157 in	TP4	1SNK900205R0000	20	2.40
5 Test connectors	Dark grey	5.2 mm 0.205 in spacing	TC5	1SNK900200R0000	10	5.20
		End module, 5.2 mm 0.205 in	TC5-R1	1SNK900201R0000	10	5.20
6 Shield connectors		SHB	1SNK900602R0000	20	4.90	
7 Label holders	Dark grey	LH-J	1SNK900606R0000	100	0.73	
8 Terminal block markers	White	Blank marker	MG-CPM 13 41790	1SNB041790R0512	1960	0.23
		Blank card	MC512	1SNK140000R0000	22	9.00
			MC512PA	1SNK149999R0000	20	10.00
	Universal wire markers holder	Grey	UMH	1SNK900611R0000	10	0.20

Complete list of accessories is indicated in the terminal block datasheet including end stops. Some accessories such as jumper bars may modify the terminal block's ratings: Complete information available in the accessories section of the catalog.

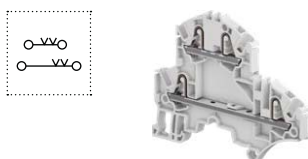

Feed-through PI-Spring terminal blocks

Description	Color	Type	Part Number	Pkg qty	Weight (1 pce)
Feed-through	Grey	ZK2.5-D2	1SNK705210R0000	50	11.20

Technical data valid for copper conductors only.

ZK2.5-D1-PE PI-Spring terminal blocks

Double deck with 1 ground circuit - 5.2 mm 0.205 in spacing



2.5 mm²
12 AWG

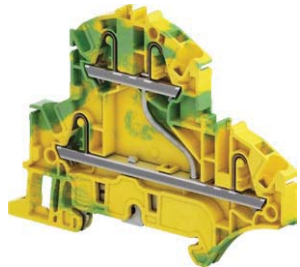

1SNK162049S0201

ZK2.5-D1-PE

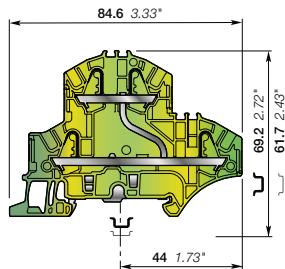

5.2 mm 0.205 in spacing

Description

Improve the safety of your installation in the event of a short-circuit thanks to our screwless rail contact:

- Rail contact non operator dependent,
- Performances above the requirements of the IEC 60947-7-2 terminal block standard,
- Secured snap on or off the rail,
- Profile aligned with ZK2.5-D2.

Ordering details

Description	Color	Type	Part Number	Pkg qty	Weight (1 pce) g
Ground 1 ground circuit	Green-yellow	ZK2.5-D1-PE	1SNK705250R0000	20	15.70

Main technical data

Connecting capacity		IEC	UL - CSA	Mounting instructions	
1 conductor per clamp	Rigid: Solid/Stranded	0.2 ... 4 mm ²	26 ... 12 AWG	Rail	TH 35-7.5, TH 35-15
	Flexible without ferrule	0.22 ... 2.5 mm ²		Wire stripping length	11 mm 0.433 in
	Flexible with non insulated ferrule	0.22 ... 2.5 mm ²	26 ... 14 AWG		
	Flexible with insulated ferrule	0.22 ... 2.5 mm ²	26 ... 14 AWG		
Rated cross section		2.5 mm ²	12 AWG	Tool (for flexible conductor without ferrule)	Flat screwdriver Ø 3.5 mm Ø 0.138 in
Rated short-time withstand current (1s)		300 A	396 A		
Protection		IP20	NEMA 1		
Explosive atmosphere classification		IM2 II 2 GD Ex eb I/IC/IIIC - Class I, Zone 1, AEx e II, Ex e II U			

The connecting capacity data for one Rigid: Solid/Stranded, or one Flexible conductor (when applicable) is a mandatory information required by IEC, UL and CSA standards (Copper conductors). All other data are provided as supplementary information only. For more details, please consult our CB, UL or CSA certificates and technical datasheet available on <http://www.TE.com>



Accessories

Description	Color	Type	Part Number	Pkg qty	Weight (1 pce) g
1 End stops 10 mm 0.394 in	Dark grey	BAZH1	1SNK900102R0000	20	24.00
2 End sections 2 mm 0.079 in	Dark grey	EK2.5-D2	1SNK705960R0000	20	3.40
3 Test adapters For test plugs DIA 2 mm 0.079 in For test plugs DIA 4 mm 0.157 in	Dark grey	TP2	1SNK900203R0000	20	1.70
		TP4	1SNK900205R0000	20	2.40
4 Test connectors 5.2 mm 0.205 in spacing End module, 5.2 mm 0.205 in	Dark grey	TC5	1SNK900200R0000	10	5.20
		TC5-R1	1SNK900201R0000	10	5.20
5 Shield connectors		SHB	1SNK900602R0000	20	4.90
6 Label holders	Dark grey	LH-J	1SNK900606R0000	100	0.73
7 Terminal block markers Blank marker Blank card Universal wire markers holder	White	MG-CPM 13 41790	1SNB041790R0512	1960	0.23
		MC512	1SNK140000R0000	22	9.00
		MC512PA	1SNK149999R0000	20	10.00
	Grey	UMH	1SNK900611R0000	10	0.20

Complete list of accessories is indicated in the terminal block datasheet including end stops. Some accessories such as jumper bars may modify the terminal block's ratings: Complete information available in the accessories section of the catalog.

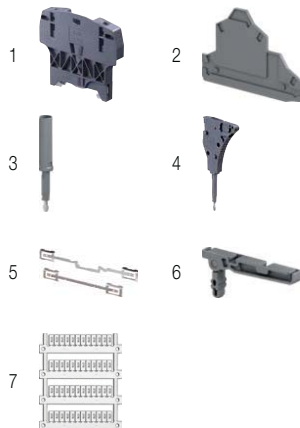

Technical data valid for copper conductors only.

ZK2.5-T3 PI-Spring terminal blocks

Triple deck with 3 feed-through circuits - 5.2 mm 0.205 in spacing



ZK2.5-T3

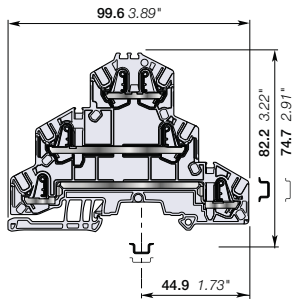

5.2 mm 0.205 in spacing

Description

Combine high performance with compact dimensions in just 5.2 mm 0.205 in spacing:
 - 500 V IEC 300 V UL,
 - 1 jumper channel and a large input and output marker zone on each deck.

Ordering details

Description	Color	Type	Part Number	Pkg qty	Weight (1 pce) g
Feed-through 3 feed-through circuits	Grey	ZK2.5-T3	1SNK705510R0000	25	17.33

Main technical data

Connecting capacity		IEC	UL - CSA	Mounting instructions	
1 conductor per clamp	Rigid: Solid/Stranded	0.2 ... 4 mm ²	26 ... 12 AWG	Rail	TH 35-7.5, TH 35-15
	Flexible without ferrule	0.22 ... 2.5 mm ²		Wire stripping length	11 mm 0.433 in
	Flexible with non insulated ferrule	0.22 ... 2.5 mm ²	26 ... 14 AWG		
	Flexible with insulated ferrule	0.22 ... 2.5 mm ²	26 ... 14 AWG		
2 conductors per clamp	Flexible with twin ferrule	0.22 ... 0.5 mm ²	26 ... 20 AWG	Tool (for flexible conductor without ferrule)	Flat screwdriver Ø 3.5 mm Ø 0.138 in
Rated current / Rated cross section		22 A / 2.5 mm ²	20 A / 12 AWG		
Rated short-time withstand current (1s)		300 A			
Short Circuit Current Rating (with specific conditions)					
Rated voltage		500 V	300 V		
Impulse withstand voltage		8000 V			
Protection		IP20	NEMA 1		
Increased safety Ex e		440 V 20 A IEC/EN 60079-7 - IM2 II 2 GD Ex eb IIC/IIC			

The connecting capacity data for one Rigid: Solid/Stranded, or one Flexible conductor (when applicable) is a mandatory information required by IEC, UL and CSA standards (Copper conductors). All other data are provided as supplementary information only. For more details, please consult our CB, UL or CSA certificates and technical datasheet available on <http://www.TE.com>



Accessories

Description	Color	Type	Part Number	Pkg qty	Weight (1 pce) g	
1 End stops 10 mm 0.394 in	Dark grey	BAZH1	1SNK900102R0000	20	24.00	
2 End sections 0.8 mm 0.031 in	Dark grey	EK2.5-T3	1SNK705961R0000	20	4.76	
3 Jumper bars	Orange	2 poles 32 A (IEC)	JB5-2	1SNK905302R0000	50	1.30
		3 poles 32 A (IEC)	JB5-3	1SNK905303R0000	50	2.00
		4 poles 32 A (IEC)	JB5-4	1SNK905304R0000	50	2.70
		5 poles 32 A (IEC)	JB5-5	1SNK905305R0000	50	3.50
		10 poles 32 A (IEC)	JB5-10	1SNK905310R0000	30	7.10
		50 poles 32 A (IEC)	JB5-50	1SNK905350R0000	10	36.00
4 Test adapters	Dark grey	For test plugs DIA 2 mm 0.079 in	TP2	1SNK900203R0000	20	1.70
		For test plugs DIA 4 mm 0.157 in	TP4	1SNK900205R0000	20	2.40
5 Test connectors 5.2 mm 0.205 in spacing	Dark grey	End module, 5.2 mm 0.205 in	TC5	1SNK900200R0000	10	5.20
			TC5-R1	1SNK900201R0000	10	5.20
6 Label holders	Dark grey		LH-J	1SNK900606R0000	100	0.73
		Blank marker	MG-CPM 13 41790	1SNB041790R0512	1960	0.23
		7 Terminal block markers	MC512	1SNK140000R0000	22	9.00
			MC512PA	1SNK149999R0000	20	10.00
	Universal wire markers holder	Grey	UMH	1SNK900611R0000	10	0.20

Complete list of accessories is indicated in the terminal block datasheet including end stops.
 Some accessories such as jumper bars may modify the terminal block's ratings: Complete information available in the accessories section of the catalog.



Ground PI-Spring terminal blocks

Description	Color	Type	Part Number	Pkg qty	Weight (1 pce) g
Ground	Green-yellow	ZK2.5-T1-PE	1SNK705550R0000	25	21.53

Technical data valid for copper conductors only.

ZK2.5-T1 PI-Spring terminal blocks

Triple deck with 1 feed-through circuit - 5.2 mm 0.205 in spacing



ZK2.5-T1

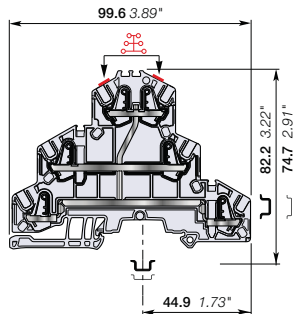

5.2 mm 0.205 in spacing

Description

Find the same functionalities as ZK2.5-T3 and ease one potential distribution on 6 independent connections.

Ordering details

Description	Color	Type	Part Number	Pkg qty	Weight (1 pce) g
Feed-through 1 feed-through circuit	Grey	ZK2.5-T1	1SNK705511R0000	25	17.33

Main technical data

Connecting capacity	IEC	UL - CSA	Mounting instructions		
1 conductor per clamp	Rigid: Solid/Stranded	0.2 ... 4 mm ²	26 ... 12 AWG	Rail	TH 35-7.5, TH 35-15
	Flexible without ferrule	0.22 ... 2.5 mm ²	26 ... 14 AWG	Wire stripping length	11 mm 0.433 in
	Flexible with non insulated ferrule	0.22 ... 2.5 mm ²	26 ... 14 AWG	Tool (for flexible conductor without ferrule)	Flat screwdriver Ø 3.5 mm Ø 0.138 in
	Flexible with insulated ferrule	0.22 ... 2.5 mm ²	26 ... 14 AWG		
2 conductors per clamp	Flexible with twin ferrule	0.22 ... 0.5 mm ²	26 ... 20 AWG		
Rated current / Rated cross section		22 A / 2.5 mm ²	20 A / 12 AWG		
Rated short-time withstand current (1s)		300 A			
Short Circuit Current Rating (with specific conditions)					
Rated voltage		500 V	300 V		
Impulse withstand voltage		8000 V			
Protection		IP20	NEMA 1		
Increased safety Ex e		440 V 20 A IEC/EN 60079-7 - IM2 II 2 GD Ex eb I/II/C/III/C			

The connecting capacity data for one Rigid: Solid/Stranded, or one Flexible conductor (when applicable) is a mandatory information required by IEC, UL and CSA standards (Copper conductors). All other data are provided as supplementary information only. For more details, please consult our CB, UL or CSA certificates and technical datasheet available on <http://www.TE.com>



Accessories

Description	Color	Type	Part Number	Pkg qty	Weight (1 pce) g	
1 End stops	Dark grey	BAZH1	1SNK900102R0000	20	24.00	
2 End sections	Dark grey	EK2.5-T3	1SNK705961R0000	20	4.76	
3 Jumper bars	Orange	2 poles	JB5-2	1SNK905302R0000	50	1.30
		3 poles	JB5-3	1SNK905303R0000	50	2.00
		4 poles	JB5-4	1SNK905304R0000	50	2.70
		5 poles	JB5-5	1SNK905305R0000	50	3.50
		10 poles	JB5-10	1SNK905310R0000	30	7.10
		50 poles	JB5-50	1SNK905350R0000	10	36.00
4 Test adapters	Dark grey	For test plugs DIA 2 mm 0.079 in	TP2	1SNK900203R0000	20	1.70
		For test plugs DIA 4 mm 0.157 in	TP4	1SNK900205R0000	20	2.40
5 Test connectors	Dark grey	5.2 mm 0.205 in spacing	TC5	1SNK900200R0000	10	5.20
		End module, 5.2 mm 0.205 in	TC5-R1	1SNK900201R0000	10	5.20
6 Label holders	Dark grey	LH-J	1SNK900606R0000	100	0.73	
7 Terminal block markers	White	Blank marker	MG-CPM 13 41790	1SNB041790R0512	1960	0.23
		Blank card	MC512	1SNK140000R0000	22	9.00
	Grey		MC512PA	1SNK149999R0000	20	10.00
		Universal wire markers holder	UMH	1SNK900611R0000	10	0.20

Complete list of accessories is indicated in the terminal block datasheet including end stops.

Some accessories such as jumper bars may modify the terminal block's ratings: Complete information available in the accessories section of the catalog.



Ground PI-Spring terminal blocks

Description	Color	Type	Part Number	Pkg qty	Weight (1 pce) g
Ground	Green-yellow	ZK2.5-T1-PE	1SNK705550R0000	25	21.53

Technical data valid for copper conductors only.

ZK2.5-L-L-PE PI-Spring terminal blocks

Triple deck with 2 feed-through circuits and 1 ground circuit - 5.2 mm 0.205 in spacing



1SNK102112R0014

ZK2.5-L-L-PE

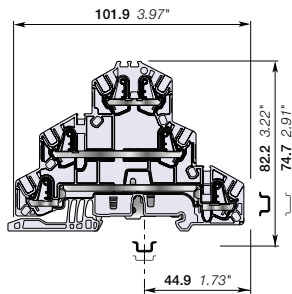

5.2 mm 0.205 in spacing

Description

Combine high performance with compact dimensions:

- 500V IEC 300 V UL,
- 2 feed through circuits and 1 ground circuit in just 5.2 mm 0.205 in spacing,
- 1 jumper channel and a large input and output marker zone on each deck,
- designed for easy wiring.

Ordering details

Description	Color	Type	Part Number	Pkg qty	Weight (1 pce) g
Feed-through + ground	Grey, Green-yellow	ZK2.5-L-L-PE	1SNK705512R0000	25	21.38

Main technical data

Connecting capacity		IEC	UL - CSA	Mounting instructions	
1 conductor per clamp	Rigid: Solid/Stranded	0.2 ... 4 mm ²	26 ... 12 AWG	Rail	TH 35-7.5, TH 35-15
	Flexible without ferrule	0.22 ... 2.5 mm ²	26 ... 12 AWG	Wire stripping length	11 mm 0.433 in
	Flexible with non insulated ferrule	0.22 ... 2.5 mm ²	26 ... 14 AWG		
	Flexible with insulated ferrule	0.22 ... 2.5 mm ²	26 ... 14 AWG		
2 conductors per clamp	Flexible with twin ferrule	0.22 ... 0.5 mm ²	26 ... 20 AWG	Tool (for flexible conductor without ferrule)	Flat screwdriver Ø 3.5 mm Ø 0.138 in
Rated current / Rated cross section		22 A / 2.5 mm ²	20 A / 12 AWG		
Rated short-time withstand current (1s)		300 A	396 A		
Short Circuit Current Rating (with specific conditions)					
Rated voltage		500 V	300 V		
Impulse withstand voltage		8000 V			
Protection		IP20	NEMA 1		
Increased safety Ex e		440 V 20 A IEC/EN 60079-7 - IM2 II 2 GD Ex eb IIC/IIIC			

The connecting capacity data for one Rigid: Solid/Stranded, or one Flexible conductor (when applicable) is a mandatory information required by IEC, UL and CSA standards (Copper conductors). All other data are provided as supplementary information only. For more details, please consult our CB, UL or CSA certificates and technical datasheet available on <http://www.TE.com>



Accessories

Description	Color	Type	Part Number	Pkg qty	Weight (1 pce) g	
1 End stops	Dark grey	BAZH1	1SNK900102R0000	20	24.00	
2 End sections	Dark grey	EK2.5-T3	1SNK705961R0000	20	4.76	
3 Jumper bars	Orange	2 poles	JB5-2	1SNK905302R0000	50	1.30
		3 poles	JB5-3	1SNK905303R0000	50	2.00
		4 poles	JB5-4	1SNK905304R0000	50	2.70
		5 poles	JB5-5	1SNK905305R0000	50	3.50
		10 poles	JB5-10	1SNK905310R0000	30	7.10
		50 poles	JB5-50	1SNK905350R0000	10	36.00
4 Test adapters	Dark grey	For test plugs DIA 2 mm 0.079 in	TP2	1SNK900203R0000	20	1.70
		For test plugs DIA 4 mm 0.157 in	TP4	1SNK900205R0000	20	2.40
5 Test connectors	Dark grey	5.2 mm 0.205 in spacing	TC5	1SNK900200R0000	10	5.20
		End module, 5.2 mm 0.205 in	TC5-R1	1SNK900201R0000	10	5.20
6 Label holders	Dark grey	LH-J	1SNK900606R0000	100	0.73	
		MG-CPM 13 41790	1SNB041790R0512	1960	0.23	
7 Terminal block markers	White	MC512	1SNK140000R0000	22	9.00	
		MC512PA	1SNK149999R0000	20	10.00	
		Universal wire markers holder	Grey	UMH	1SNK900611R0000	10

Complete list of accessories is indicated in the terminal block datasheet including end stops. Some accessories such as jumper bars may modify the terminal block's ratings: Complete information available in the accessories section of the catalog.



Feed-through PI-Spring terminal blocks

Description	Color	Type	Part Number	Pkg qty	Weight (1 pce) g
Feed-through	Grey	ZK2.5-T3	1SNK705510R0000	25	17.33

Technical data valid for copper conductors only.

ZK2.5-L-N-PE PI-Spring terminal blocks

Triple deck with 2 feed-through circuits and 1 ground circuit - 5.2 mm 0.205 in spacing



ZK2.5-L-N-PE

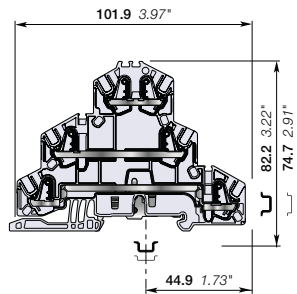

5.2 mm 0.205 in spacing

Description

Combine high performance with compact dimensions:

- 500 V IEC 300 V UL,
- 2 feed through circuits, phase and neutral, and 1 ground circuit in just 5.2 mm 0.205 in spacing,
- 1 jumper channel and a large input and output marker zone on each deck,
- designed for easy wiring.

Ordering details

Description	Color	Type	Part Number	Pkg qty	Weight (1 pce) g
Feed-through + ground	Blue, grey, Green-yellow	ZK2.5-L-N-PE	1SNK705513R0000	25	21.38

Main technical data

Connecting capacity		IEC	UL - CSA	Mounting instructions	
1 conductor per clamp	Rigid: Solid/Stranded	0.2 ... 4 mm²	26 ... 12 AWG	Rail	TH 35-7.5, TH 35-15
	Flexible without ferrule	0.22 ... 2.5 mm²	26 ... 14 AWG		
	Flexible with non insulated ferrule	0.22 ... 2.5 mm²	26 ... 14 AWG	Wire stripping length	11 mm 0.433 in
	Flexible with insulated ferrule	0.22 ... 2.5 mm²	26 ... 14 AWG		
2 conductors per clamp	Flexible with twin ferrule	0.22 ... 0.5 mm²	26 ... 20 AWG	Tool (for flexible conductor without ferrule)	Flat screwdriver Ø 3.5 mm Ø 0.138 in
Rated current / Rated cross section		22 A / 2.5 mm²	20 A / 12 AWG		
Rated short-time withstand current (1s)		300 A	396 A		
Short Circuit Current Rating (with specific conditions)					
Rated voltage		500 V	300 V		
Impulse withstand voltage		8000 V			
Protection		IP20	NEMA 1		
Increased safety Ex e		440 V 20 A IEC/EN 60079-7 - IM2 II 2 GD Ex eb I/IC/IIIC			

The connecting capacity data for one Rigid: Solid/Stranded, or one Flexible conductor (when applicable) is a mandatory information required by IEC, UL and CSA standards (Copper conductors). All other data are provided as supplementary information only. For more details, please consult our CB, UL or CSA certificates and technical datasheet available on <http://www.TE.com>



Accessories

Description	Color	Type	Part Number	Pkg qty	Weight (1 pce) g	
1 End stops	Dark grey	BAZH1	1SNK900102R0000	20	24.00	
2 End sections	Dark grey	EK2.5-T3	1SNK705961R0000	20	4.76	
3 Jumper bars	Orange	2 poles	JB5-2	1SNK905302R0000	50	1.30
		3 poles	JB5-3	1SNK905303R0000	50	2.00
		4 poles	JB5-4	1SNK905304R0000	50	2.70
		5 poles	JB5-5	1SNK905305R0000	50	3.50
		10 poles	JB5-10	1SNK905310R0000	30	7.10
		50 poles	JB5-50	1SNK905350R0000	10	36.00
4 Test adapters	Dark grey	For test plugs DIA 2 mm 0.079 in	TP2	1SNK900203R0000	20	1.70
		For test plugs DIA 4 mm 0.157 in	TP4	1SNK900205R0000	20	2.40
5 Test connectors	Dark grey	5.2 mm 0.205 in spacing	TC5	1SNK900200R0000	10	5.20
		End module, 5.2 mm 0.205 in	TC5-R1	1SNK900201R0000	10	5.20
6 Label holders	Dark grey	LH-J	1SNK900606R0000	100	0.73	
7 Terminal block markers	Blank marker	Blank marker	MG-CPM 13 41790	1SNB041790R0512	1960	0.23
		Blank card	MC512	1SNK140000R0000	22	9.00
	Universal wire markers holder	MC512PA	1SNK149999R0000	20	10.00	
		Grey	UMH	1SNK900611R0000	10	0.20

Complete list of accessories is indicated in the terminal block datasheet including end stops. Some accessories such as jumper bars may modify the terminal block's ratings: Complete information available in the accessories section of the catalog.



Feed-through PI-Spring terminal blocks

Description	Color	Type	Part Number	Pkg qty	Weight (1 pce) g
Feed-through	Grey	ZK2.5-T3	1SNK705510R0000	25	17.33

Technical data valid for copper conductors only.

ZK2.5-T1-PE PI-Spring terminal blocks

Triple deck with 1 ground circuit - 5.2 mm 0.205 in spacing



1SNK16211190014

ZK2.5-T1-PE

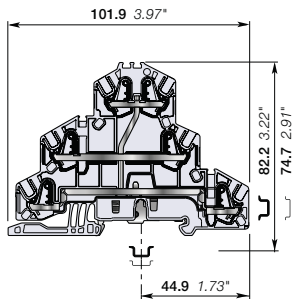

5.2 mm 0.205 in spacing

Description

Improve the safety of your installation in the event of a short-circuit thanks to our screwless rail contact:

- Rail contact non operator dependent,
- Performances above the requirements of the IEC 60947-7-2 terminal block standard,
- Secured snap on or off the rail,
- Profile aligned with ZK2.5-T3,
- 1 jumper channel on bottom and middle decks.

Ordering details

Description	Color	Type	Part Number	Pkg qty	Weight (1 pce) g
Ground 1 ground circuit	Green-yellow	ZK2.5-T1-PE	1SNK705550R0000	25	21.53

Main technical data

Connecting capacity		IEC	UL - CSA
1 conductor per clamp	Rigid: Solid/Stranded	0.2 ... 4 mm ²	26 ... 12 AWG
	Flexible without ferrule	0.22 ... 2.5 mm ²	
	Flexible with non insulated ferrule	0.22 ... 2.5 mm ²	26 ... 14 AWG
	Flexible with insulated ferrule	0.22 ... 2.5 mm ²	26 ... 14 AWG
Rated cross section		2.5 mm ²	12 AWG
Rated short-time withstand current (1s)		300 A	396 A
Protection		IP20	NEMA 1

Mounting instructions

Rail		TH 35-7.5, TH 35-15
Wire stripping length		11 mm 0.433 in
Tool (for flexible conductor without ferrule)		Flat screwdriver Ø 3.5 mm Ø 0.138 in

Explosive atmosphere classification

IM2 II 2 GD Ex eb I/IC/IIIC
The connecting capacity data for one Rigid: Solid/Stranded, or one Flexible conductor (when applicable) is a mandatory information required by IEC, UL and CSA standards (Copper conductors). All other data are provided as supplementary information only. For more details, please consult our CB, UL or CSA certificates and technical datasheet available on <http://www.TE.com>



Accessories

Description	Color	Type	Part Number	Pkg qty	Weight (1 pce) g
1 End stops 10 mm 0.394 in	Dark grey	BZH1	1SNK900102R0000	20	24.00
2 End sections 0.8 mm 0.031 in	Dark grey	EK2.5-T3	1SNK705961R0000	20	4.76
3 Test adapters For test plugs DIA 2 mm 0.079 in For test plugs DIA 4 mm 0.157 in	Dark grey	TP2	1SNK900203R0000	20	1.70
		TP4	1SNK900205R0000	20	2.40
4 Test connectors 5.2 mm 0.205 in spacing End module, 5.2 mm 0.205 in	Dark grey	TC5	1SNK900200R0000	10	5.20
		TC5-R1	1SNK900201R0000	10	5.20
5 Label holders	Dark grey	LH-J	1SNK900606R0000	100	0.73
6 Terminal block markers Blank marker Blank card Universal wire markers holder	White	MG-CPM 13 41790	1SNB041790R0512	1960	0.23
		MC512	1SNK140000R0000	22	9.00
		MC512PA	1SNK149999R0000	20	10.00
	Grey	UMH	1SNK900611R0000	10	0.20

Complete list of accessories is indicated in the terminal block datasheet including end stops.

Some accessories such as jumper bars may modify the terminal block's ratings: Complete information available in the accessories section of the catalog.

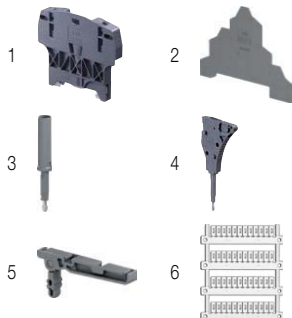

Technical data valid for copper conductors only.

ZK2.5-CH-4P-LR PI-Spring terminal blocks

Component holder - 5.2 mm 0.205 in spacing



2.5 mm²
12 AWG

Description

- Protect your circuit with one 1N4007 diode,
- Clear identification of the diode orientation with marking identification on the top of the terminal block

Ordering details

Description	Color	Type	Part Number	Pkg qty	Weight (1 pce) g
Component holder with 1 test socket DIA 2 mm 0.079 in	Grey <input type="checkbox"/>	ZK2.5-CH-4P-LR	1SNK705710R0000	50	10.91

Main technical data

Connecting capacity		IEC	UL - CSA	Mounting instructions	
1 conductor per clamp	Rigid: Solid/Stranded	0.2 ... 4 mm ²	26 ... 12 AWG	Rail	TH 35-7.5, TH 35-15
	Flexible without ferrule	0.22 ... 2.5 mm ²	26 ... 14 AWG	Wire stripping length	11 mm 0.433 in
	Flexible with non insulated ferrule	0.22 ... 2.5 mm ²	26 ... 14 AWG	Tool (for flexible conductor without ferrule)	Flat screwdriver Ø 3.5 mm Ø 0.138 in
	Flexible with insulated ferrule	0.22 ... 2.5 mm ²	26 ... 14 AWG		
2 conductors per clamp	Flexible with twin ferrule	0.22 ... 0.5 mm ²	26 ... 20 AWG		
Rated current / Rated cross section		1 A / 2.5 mm ²	1 A / 12 AWG		
Rated short-time withstand current (1s)					
Short Circuit Current Rating (with specific conditions)					
Rated voltage		630 V	300 V		
Impulse withstand voltage					
Protection		IP20	NEMA 1		



ZK2.5-CH-4P

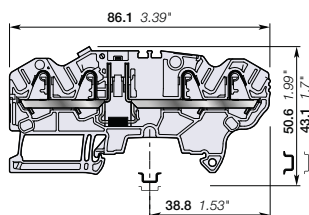

5.2 mm 0.205 in spacing

The connecting capacity data for one Rigid: Solid/Stranded, or one Flexible conductor (when applicable) is a mandatory information required by IEC, UL and CSA standards (Copper conductors). All other data are provided as supplementary information only. For more details, please consult our CB, UL or CSA certificates and technical datasheet available on <http://www.TE.com>

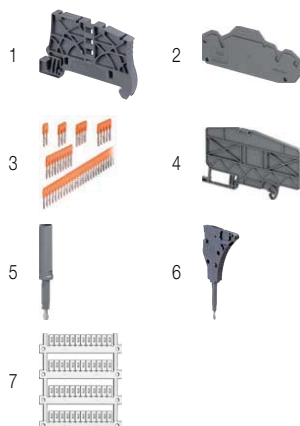

Accessories

Description	Color	Type	Part Number	Pkg qty	Weight (1 pce) g	
1 End stops	Dark grey <input type="checkbox"/>	BAZ1	1SNK900002R0000	50	5.30	
2 End sections	Dark grey <input type="checkbox"/>	EK2.5-S-4P	1SNK705913R0000	20	2.94	
3 Jumper bars	Orange <input type="checkbox"/>	2 poles	JB5-2	1SNK905302R0000	50	1.30
		3 poles	JB5-3	1SNK905303R0000	50	2.00
		4 poles	JB5-4	1SNK905304R0000	50	2.70
		5 poles	JB5-5	1SNK905305R0000	50	3.50
		10 poles	JB5-10	1SNK905310R0000	30	7.10
		50 poles	JB5-50	1SNK905350R0000	10	36.00
4 Circuit separators	Dark grey <input type="checkbox"/>	CS-R3	1SNK900107R0000	20	6.40	
5 Test adapters	Dark grey <input type="checkbox"/>	For test plugs DIA 2 mm 0.079 in	TP2	1SNK900203R0000	20	1.70
		For test plugs DIA 4 mm 0.157 in	TP4	1SNK900205R0000	20	2.40
		5.2 mm 0.205 in spacing	TC5	1SNK900200R0000	10	5.20
6 Test connectors	Dark grey <input type="checkbox"/>	End module, 5.2 mm 0.205 in	TC5-R1	1SNK900201R0000	10	5.20
		Blank marker	MG-CPM 13 41790	1SNK041790R0512	1960	0.23
7 Terminal block markers	White <input type="checkbox"/>	Blank marker	MC512	1SNK140000R0000	22	9.00
		Blank card	MC512PA	1SNK149999R0000	20	10.00
		Universal wire markers holder	UMH	1SNK900611R0000	10	0.20

Complete list of accessories is indicated in the terminal block datasheet including end stops. Some accessories such as jumper bars may modify the terminal block's ratings. Complete information available in the accessories section of the catalog.

Technical data valid for copper conductors only.

ZK2.5-CH-4P-RL PI-Spring terminal blocks

Component holder - 5.2 mm 0.205 in spacing



ZK2.5-CH-4P

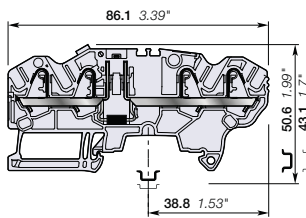

5.2 mm 0.205 in spacing

Description

- Protect your circuit with one 1N4007 diode,
- Clear identification of the diode orientation with marking identification on the top of the terminal block

Ordering details

Description	Color	Type	Part Number	Pkg qty	Weight (1 pce) g
Component holder with 1 test socket DIA 2 mm 0.079 in	Grey <input type="checkbox"/>	ZK2.5-CH-4P-RL	1SNK705711R0000	50	10.91

Main technical data

Connecting capacity	IEC	UL - CSA	Mounting instructions	
1 conductor per clamp	Rigid: Solid/Stranded Flexible without ferrule Flexible with non insulated ferrule Flexible with insulated ferrule	0.2 ... 4 mm ² 0.22 ... 2.5 mm ² 0.22 ... 2.5 mm ² 0.22 ... 2.5 mm ²	26 ... 12 AWG 26 ... 14 AWG 26 ... 14 AWG	Rail TH 35-7.5, TH 35-15 Wire stripping length 11 mm 0.433 in
2 conductors per clamp	Flexible with twin ferrule	0.22 ... 0.5 mm ²	26 ... 20 AWG	Tool (for flexible conductor without ferrule) Flat screwdriver Ø 3.5 mm Ø 0.138 in
Rated current / Rated cross section		1 A / 2.5 mm ²	1 A / 12 AWG	
Rated short-time withstand current (1s)				
Short Circuit Current Rating (with specific conditions)				
Rated voltage		630 V	300 V	
Impulse withstand voltage				
Protection		IP20	NEMA 1	

The connecting capacity data for one Rigid: Solid/Stranded, or one Flexible conductor (when applicable) is a mandatory information required by IEC, UL and CSA standards (Copper conductors). All other data are provided as supplementary information only. For more details, please consult our CB, UL or CSA certificates and technical datasheet available on <http://www.TE.com>



Accessories

Description	Color	Type	Part Number	Pkg qty	Weight (1 pce) g
1 End stops 5.2 mm 0.205 in	Dark grey <input checked="" type="checkbox"/>	BAZ1	1SNK900002R0000	50	5.30
2 End sections 2 mm 0.158 in	Dark grey <input checked="" type="checkbox"/>	EK2.5-S-4P	1SNK705913R0000	20	2.94
3 Jumper bars	Orange <input checked="" type="checkbox"/>	JB5-2	1SNK905302R0000	50	1.30
2 poles 32 A (IEC)		JB5-3	1SNK905303R0000	50	2.00
3 poles 32 A (IEC)		JB5-4	1SNK905304R0000	50	2.70
4 poles 32 A (IEC)		JB5-5	1SNK905305R0000	50	3.50
5 poles 32 A (IEC)		JB5-10	1SNK905310R0000	30	7.10
10 poles 32 A (IEC)		JB5-50	1SNK905350R0000	10	36.00
50 poles 32 A (IEC)					
4 Circuit separators 3 mm 0.118 in	Dark grey <input checked="" type="checkbox"/>	CS-R3	1SNK900107R0000	20	6.40
5 Test adapters	Dark grey <input checked="" type="checkbox"/>	TP2	1SNK900203R0000	20	1.70
For test plugs DIA 2 mm 0.079 in		TP4	1SNK900205R0000	20	2.40
For test plugs DIA 4 mm 0.157 in					
6 Test connectors	Dark grey <input checked="" type="checkbox"/>	TC5	1SNK900200R0000	10	5.20
5.2 mm 0.205 in spacing		TC5-R1	1SNK900201R0000	10	5.20
End module, 5.2 mm 0.205 in					
7 Terminal block markers	White <input type="checkbox"/>	MG-CPM 13 41790	1SNB041790R0512	1960	0.23
Blank marker		MC512	1SNK140000R0000	22	9.00
Blank card		MC512PA	1SNK149999R0000	20	10.00
Universal wire markers holder	Grey <input type="checkbox"/>	UMH	1SNK900611R0000	10	0.20

Complete list of accessories is indicated in the terminal block datasheet including end stops. Some accessories such as jumper bars may modify the terminal block's ratings: Complete information available in the accessories section of the catalog.

Technical data valid for copper conductors only.

ZK2.5-D-CH-UD PI-Spring terminal blocks

Component holder - 5.2 mm 0.205 in spacing



Description

Protect your circuit with one 1N4007 diode.

Ordering details

Description	Color	Type	Part Number	Pkg qty	Weight (1 pce) g
Component holder	Grey <input type="checkbox"/>	ZK2.5-D-CH-UD	1SNK705213R0000	50	11.20

Main technical data

Connecting capacity		IEC	UL - CSA	Mounting instructions	
1 conductor per clamp	Rigid: Solid/Stranded	0.2 ... 4 mm²	26 ... 12 AWG	Rail	TH 35-7.5, TH 35-15
	Flexible without ferrule	0.22 ... 2.5 mm²		Wire stripping length	11 mm 0.443 in
	Flexible with non insulated ferrule	0.22 ... 2.5 mm²	26 ... 14 AWG		
	Flexible with insulated ferrule	0.22 ... 2.5 mm²	26 ... 14 AWG		
2 conductors per clamp	Flexible with twin ferrule	0.22 ... 0.5 mm²	26 ... 20 AWG	Tool (for flexible conductor without ferrule)	Flat screwdriver Ø 3.5 mm Ø 0.138 in
Rated current / Rated cross section		24 A / 2.5 mm²	20 A / 12 AWG		
Rated short-time withstand current (1s)		300 A			
Short Circuit Current Rating (with specific conditions)					
Rated voltage		800 V	600 V		
Impulse withstand voltage					
Protection		IP20	NEMA 1		

The connecting capacity data for one Rigid: Solid/Stranded, or one Flexible conductor (when applicable) is a mandatory information required by IEC, UL and CSA standards (Copper conductors). All other data are provided as supplementary information only. For more details, please consult our CB, UL or CSA certificates and technical datasheet available on <http://www.TE.com>



ZK2.5-D-CH

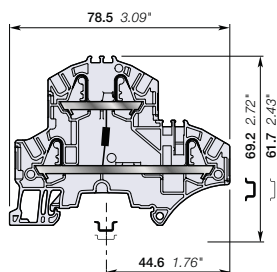

5.2 mm 0.205 in spacing

Accessories

Description	Color	Type	Part Number	Pkg qty	Weight (1 pce) g	
1 End stops	Dark grey <input type="checkbox"/>	BAZH1	1SNK900102R0000	20	24.00	
2 End sections	Dark grey <input type="checkbox"/>	EK2.5-D2	1SNK705960R0000	20	3.40	
3 Jumper bars	Orange <input type="checkbox"/>	2 poles	JB5-2	1SNK905302R0000	50	1.30
		3 poles	JB5-3	1SNK905303R0000	50	2.00
		4 poles	JB5-4	1SNK905304R0000	50	2.70
		5 poles	JB5-5	1SNK905305R0000	50	3.50
		10 poles	JB5-10	1SNK905310R0000	30	7.10
		50 poles	JB5-50	1SNK905350R0000	10	36.00
4 Test adapters	Dark grey <input type="checkbox"/>	For test plugs DIA 2 mm 0.079 in	TP2	1SNK900203R0000	20	1.70
		For test plugs DIA 4 mm 0.157 in	TP4	1SNK900205R0000	20	2.40
5 Test connectors	Dark grey <input type="checkbox"/>	5.2 mm 0.205 in spacing	TC5	1SNK900200R0000	10	5.20
		End module, 5.2 mm 0.205 in	TC5-R1	1SNK900201R0000	10	5.20
			SHB	1SNK900602R0000	20	4.90
6 Shield connectors						
7 Label holders	Dark grey <input type="checkbox"/>	LH-J	1SNK900606R0000	100	0.73	
8 Terminal block markers	White <input type="checkbox"/>	Blank marker	MG-CPM 13 41790	1SNB041790R0512	1960	0.23
		Blank card	MC512	1SNK140000R0000	22	9.00
			MC512PA	1SNK149999R0000	20	10.00
	Universal wire markers holder	Grey <input type="checkbox"/>	UMH	1SNK900611R0000	10	0.20

Complete list of accessories is indicated in the terminal block datasheet including end stops. Some accessories such as jumper bars may modify the terminal block's ratings: Complete information available in the accessories section of the catalog.

Technical data valid for copper conductors only.

ZK2.5-D-CH-DU PI-Spring terminal blocks

Component holder - 5.2 mm 0.205 in spacing



2.5 mm²
12 AWG

Description

Protect your circuit with one 1N4007 diode.

Ordering details

Description	Color	Type	Part Number	Pkg qty	Weight (1 pce) g
Component holder	Grey <input type="checkbox"/>	ZK2.5-D-CH-DU	1SNK705214R0000	50	11.20

Main technical data

Connecting capacity		IEC	UL - CSA	Mounting instructions	
1 conductor per clamp	Rigid: Solid/Stranded	0.2 ... 4 mm ²	26 ... 12 AWG	Rail	TH 35-7.5, TH 35-15
	Flexible without ferrule	0.22 ... 2.5 mm ²		Wire stripping length	11 mm 0.443 in
	Flexible with non insulated ferrule	0.22 ... 2.5 mm ²	26 ... 14 AWG	Tool (for flexible conductor without ferrule)	Flat screwdriver Ø 3.5 mm Ø 0.138 in
	Flexible with insulated ferrule	0.22 ... 2.5 mm ²	26 ... 14 AWG		
2 conductors per clamp	Flexible with twin ferrule	0.22 ... 0.5 mm ²	26 ... 20 AWG		
Rated current / Rated cross section		24 A / 2.5 mm ²	20 A / 12 AWG		
Rated short-time withstand current (1s)		300 A			
Short Circuit Current Rating (with specific conditions)					
Rated voltage		800 V	600 V		
Impulse withstand voltage					
Protection		IP20	NEMA 1		

The connecting capacity data for one Rigid: Solid/Stranded, or one Flexible conductor (when applicable) is a mandatory information required by IEC, UL and CSA standards (Copper conductors). All other data are provided as supplementary information only. For more details, please consult our CB, UL or CSA certificates and technical datasheet available on <http://www.TE.com>

CE	RoHS	UL	CSA	ERC	EAC
----	------	----	-----	-----	-----



1SNK162102X0014

ZK2.5-D-CH

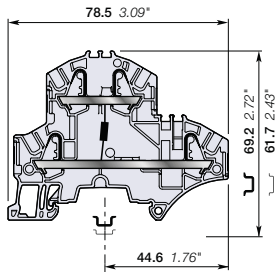

5.2 mm 0.205 in spacing

Accessories

Description	Color	Type	Part Number	Pkg qty	Weight (1 pce) g	
1 End stops 10 mm 0.394 in	Dark grey <input checked="" type="checkbox"/>	BAZH1	1SNK900102R0000	20	24.00	
2 End sections 2 mm 0.079 in	Dark grey <input checked="" type="checkbox"/>	EK2.5-D2	1SNK705960R0000	20	3.40	
3 Jumper bars	Orange <input checked="" type="checkbox"/>	2 poles 32 A (IEC)	JB5-2	1SNK905302R0000	50	1.30
		3 poles 32 A (IEC)	JB5-3	1SNK905303R0000	50	2.00
		4 poles 32 A (IEC)	JB5-4	1SNK905304R0000	50	2.70
		5 poles 32 A (IEC)	JB5-5	1SNK905305R0000	50	3.50
		10 poles 32 A (IEC)	JB5-10	1SNK905310R0000	30	7.10
4 Test adapters	Dark grey <input checked="" type="checkbox"/>	50 poles 32 A (IEC)	JB5-50	1SNK905350R0000	10	36.00
		For test plugs DIA 2 mm 0.079 in	TP2	1SNK900203R0000	20	1.70
		For test plugs DIA 4 mm 0.157 in	TP4	1SNK900205R0000	20	2.40
5 Test connectors	Dark grey <input checked="" type="checkbox"/>	5.2 mm 0.205 in spacing	TC5	1SNK900200R0000	10	5.20
		End module, 5.2 mm 0.205 in	TC5-R1	1SNK900201R0000	10	5.20
6 Shield connectors		SHB	1SNK900602R0000	20	4.90	
7 Label holders	Dark grey <input checked="" type="checkbox"/>	LH-J	1SNK900606R0000	100	0.73	
8 Terminal block markers	White <input type="checkbox"/>	Blank marker	MG-CPM 13 41790	1SNB041790R0512	1960	0.23
		Blank card	MC512	1SNK140000R0000	22	9.00
			MC512PA	1SNK149999R0000	20	10.00
	Universal wire markers holder	Grey <input type="checkbox"/>	UMH	1SNK900611R0000	10	0.20

Complete list of accessories is indicated in the terminal block datasheet including end stops. Some accessories such as jumper bars may modify the terminal block's ratings: Complete information available in the accessories section of the catalog.

Technical data valid for copper conductors only.

ZK2.5-D-CH2-DU-RL PI-Spring terminal blocks

Component holder - 5.2 mm 0.205 in spacing



Description

- Protect your circuit with 1N4007 diodes;
- Convenient identification of the diodes orientation on the terminal block front side.

Ordering details

Description	Color	Type	Part Number	Pkg qty	Weight (1 pce) g
Component holder	Grey <input type="checkbox"/>	ZK2.5-D-CH2-DU-RL	1SNK705219R0000	50	11.20

Main technical data

Connecting capacity		IEC	UL - CSA	Mounting instructions	
1 conductor per clamp	Rigid: Solid/Stranded	0.2 ... 4 mm ²	26 ... 12 AWG	Rail	TH 35-7.5, TH 35-15
	Flexible without ferrule	0.22 ... 2.5 mm ²		Wire stripping length	11 mm 0.443 in
	Flexible with non insulated ferrule	0.22 ... 2.5 mm ²	26 ... 14 AWG		
	Flexible with insulated ferrule	0.22 ... 2.5 mm ²	26 ... 14 AWG		
2 conductors per clamp	Flexible with twin ferrule	0.22 ... 0.5 mm ²	26 ... 20 AWG	Tool (for flexible conductor without ferrule)	Flat screwdriver Ø 3.5 mm Ø 0.138 in
Rated current / Rated cross section		1 A / 2.5 mm ² / 12 AWG			
Rated short-time withstand current (1s)					
Short Circuit Current Rating (with specific conditions)					
Rated voltage		800 V	600 V		
Impulse withstand voltage					
Protection		IP20	NEMA 1		



ZK2.5-D-CH2

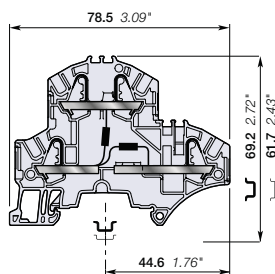

5.2 mm 0.205 in spacing

The connecting capacity data for one Rigid: Solid/Stranded, or one Flexible conductor (when applicable) is a mandatory information required by IEC, UL and CSA standards (Copper conductors). All other data are provided as supplementary information only. For more details, please consult our CB, UL or CSA certificates and technical datasheet available on <http://www.TE.com>

--	--	--	--	--	--	--	--	--	--



Accessories

Description	Color	Type	Part Number	Pkg qty	Weight (1 pce) g	
1 End stops	Dark grey <input checked="" type="checkbox"/>	BAZH1	1SNK900102R0000	20	24.00	
2 End sections	Dark grey <input checked="" type="checkbox"/>	EK2.5-D2	1SNK705960R0000	20	3.40	
3 Jumper bars	Orange <input checked="" type="checkbox"/>	2 poles	JB5-2	1SNK905302R0000	50	1.30
		3 poles	JB5-3	1SNK905303R0000	50	2.00
		4 poles	JB5-4	1SNK905304R0000	50	2.70
		5 poles	JB5-5	1SNK905305R0000	50	3.50
		10 poles	JB5-10	1SNK905310R0000	30	7.10
		50 poles	JB5-50	1SNK905350R0000	10	36.00
4 Test adapters	Dark grey <input checked="" type="checkbox"/>	For test plugs DIA 2 mm 0.079 in	TP2	1SNK900203R0000	20	1.70
		For test plugs DIA 4 mm 0.157 in	TP4	1SNK900205R0000	20	2.40
5 Test connectors	Dark grey <input checked="" type="checkbox"/>	5.2 mm 0.205 in spacing	TC5	1SNK900200R0000	10	5.20
		End module, 5.2 mm 0.205 in	TC5-R1	1SNK900201R0000	10	5.20
			SHB	1SNK900602R0000	20	4.90
6 Shield connectors	White <input type="checkbox"/>	Blank marker	MG-CPM 13 41790	1SNB041790R0512	1960	0.23
		Blank card	MC512	1SNK140000R0000	22	9.00
			MC512PA	1SNK149999R0000	20	10.00
		Universal wire markers holder	Grey <input type="checkbox"/>	UMH	1SNK900611R0000	10

Complete list of accessories is indicated in the terminal block datasheet including end stops. Some accessories such as jumper bars may modify the terminal block's ratings: Complete information available in the accessories section of the catalog.

Technical data valid for copper conductors only.



SNK series, terminal blocks

Screw clamp technology



Technologies presentation		72
Overview		76
Feed-through		
4 mm ² / 12 AWG	ZS4	80
6 mm ² / 10 AWG	ZS6	81
	ZS6-3S and ZS6-4S	with 3 and 4 connections 82-83
10 mm ² / 6 AWG	ZS10	84
16 mm ² / 4 AWG	ZS16	85
25 mm ² / 3 AWG	ZS25	86
35 mm ² / 0 AWG	ZS35	87
50 mm ² / 0 AWG	ZS50	88
70 mm ² / 00 AWG	ZS70	89
95 mm ² / 0000 AWG	ZS95	90
150 mm ² / 350 Kcmil	ZS150	91
240 mm ² / 240 Kcmil	ZS240	92
Ground		
4 mm ² / 12 AWG	ZS4-PE	93
6 mm ² / 10 AWG	ZS6-PE	94
	ZS6-3S-PE and ZS6-4S-PE	with 3 and 4 connections 95-96
10 mm ² / 6 AWG	ZS10-PE	97
16 mm ² / 4 AWG	ZS16-PE	98
25 mm ² / 3 AWG	ZS25-PE	99
35 mm ² / 2 AWG	ZS35-PE	100
35 mm ²	ZS35-PEN	+ neutral 101
50 mm ² / 0 AWG	ZS50-PE	102
70 mm ² / 00 AWG	ZS70-PE	103
95 mm ² / 0000 AWG	ZS95-PE	104
Disconnect with blade		
4 mm ² / 10 AWG	ZS4-S, ZS4-S-T, ZS4-S-R1 and ZS4-S-T-R1	with test 105-108
6 mm ² / 10 AWG	ZS6-S and ZS6-S-4S-T	with test 109-110
10 mm ² / 6 AWG	ZS10-S	111
Disconnect with plug		
4 mm ² / 10 AWG	ZS4-SP, ZS4-SP-T2, ZS4-SP-R1 and ZS4-SP-T2-R1	with test 112-115
10 mm ² / 6 AWG	ZS10-SP	116
Fuse and marshalling cabinets application overview		
		118
For 5x20 and 5x25 mm fuses		
4 mm ² / 10 AWG	ZS4-SF1 and ZS4-SF1-T	with test 120-121
	ZS4-SF1-R	with fuse indicator and test 122-123
	ZS4-R1	feed-through 124
	ZS4-S-R3	disconnect with lever 125
For 5x20 mm fuses and marshalling cabinets application		
4 mm ² / 10 AWG	ZS4-SF	126
	ZS4-SF-T	with test 127
	ZS4-SF-R	with fuse indicator and test 128-129
	ZS4-R2	feed-through 130
	ZS4-PE-R2	ground 131
	ZS4-S-R2	disconnect with lever 132
For 6.3x32 mm fuses (¼ x 1¼ in)		
10 mm ² / 6 AWG	ZS10-SF	133
	ZS10-SF-R	with fuse indicator 134
	ZS10-S-R2	disconnect with lever 135
Double deck		
4 mm ² / 12 AWG	ZS4-D2 and ZS4-D1	2 and 1 feed-through circuits 136-137
6 mm ² / 10 AWG	ZS6-D2 and ZS6-D1	2 and 1 feed-through circuits 138-139
	ZS6-D2-PE	1 feed-through circuit and 1 ground circuit 140
	ZS6-D1-PE	1 ground circuit 141
4 mm ² / 10 AWG	ZS4-D2-S	1 disconnect circuit and 1 feed-through circuit 142
	ZS4-D2-S-T	1 disconnect circuit + test and 1 feed-through circuit 143
	ZS4-D2-SF1	1 fuse circuit and 1 feed-through circuit 144
	ZS4-D2-SF1-R	1 fuse circuit + fuse indicator and 1 feed-through circuit 145
Triple deck		
4 mm ² / 12 AWG	ZS4-T3	3 feed-through circuits 146
4 mm ² / 10 AWG	ZS4-T3-R1	3 feed-through circuits 147
Component holder		
4 mm ² / 12 AWG	ZS4-D-CH-UD and ZS4-D-CH-DU	148-149
Test and measurement		
Overview		
10 mm ² / 6 AWG	ZS10-ST	150
	ZS10-ST-1	for Potential Transformer circuits 154
	ZS10-ST-T4	for Current Transformer circuits 155
	ZS10-R1	feed-through 156
	ZS10-PE-R1	ground 157

Screw clamp technology - SNK series, terminal blocks

Features and benefits

TE Connectivity screw clamp technology benefits from 60 years of experience.

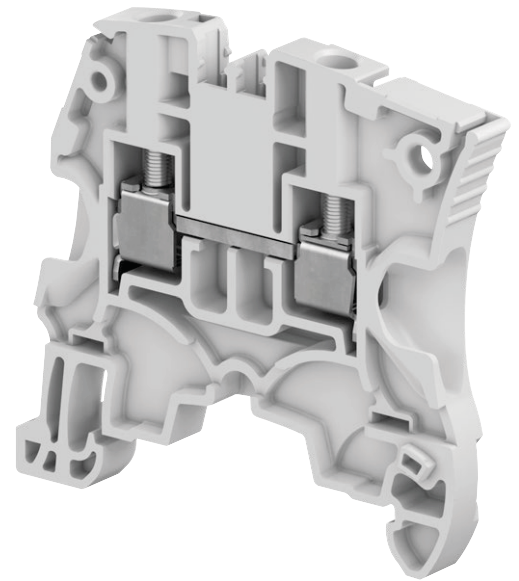

Speed up your projects

An optimized conductor guiding

Smooth connection process up to 2 conductors with or without ferrules thanks to funnel entry shape.

Also perfectly adapted to double ferrule shape **1**

Security: flap avoiding the insertion of cable underneath the clamp **2**.

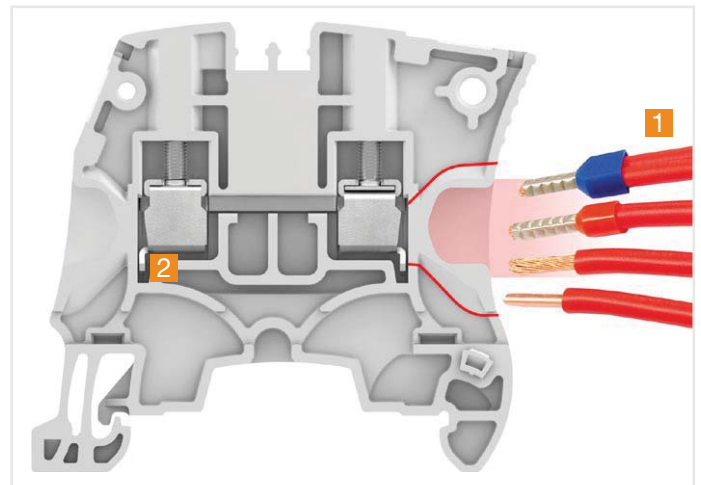

Engineered conductor entry

Better project identification

- Circuit identification is improved thanks to the 20% larger marking area
- Pre-mark by hand or with label on our flat marking surface and start immediately the wiring, before the final markers mounting
- Spare markers re-printing in case of modifications.

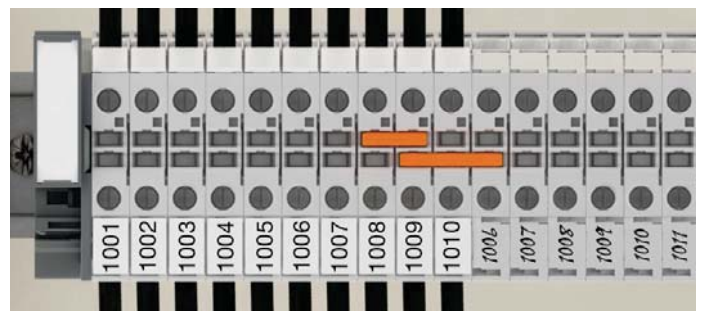

Clear circuit identification

1SNK161092S0201

Screw clamp technology - SNK series, terminal blocks

Features and benefits

Easy to install

Smart design facilitating assembly process.

Mounting, wiring, testing... made easy.

Avoid mounting and wiring errors: asymmetrical design allows immediate visual check in case of reversed terminal blocks.

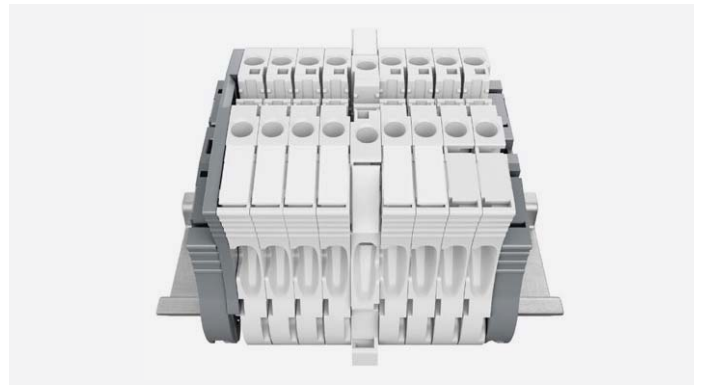

Asymmetrical design avoids mounting error

Minimize retightening campaigns

High torque resistance : the clamp is punched to increase the number of threads in contact by 30 % **1**.

The TE Connectivity exclusive anti-release system creates a controlled locking-screw effect reinforced by the 2 overlapping tabs that maintain the clamp parts **2**.

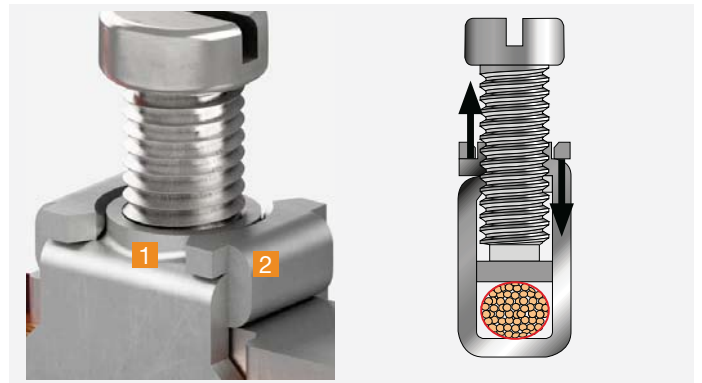

High torque resistance

Anti-release system

Faster accessories mounting

Save up to 70% mounting time thanks to screwless accessories: jumpers, component plugs, test devices, end stops and snap-in ground terminal blocks.

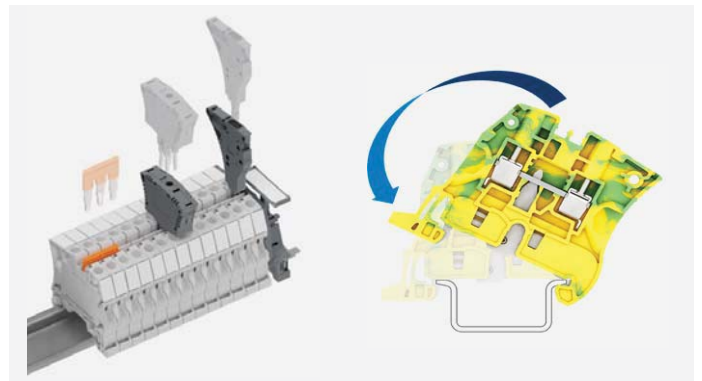

Screwless accessories

Snap-in ground terminal block for rapid installation

Screw clamp technology - SNK series, terminal blocks

Features and benefits

Easy to install

Smart design facilitating assembly process.

Mounting, wiring, testing... made easy.

Locking pin **1** allows quick and easy lock up to ten blocks in position at a time.

Closed jumper location allows great stiffness of the terminal block, optimal jumper guiding and avoids deflections while tightening.

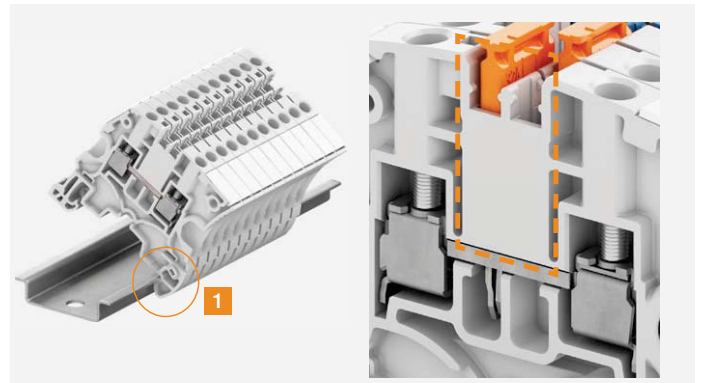

Lock up to ten blocks in position at a time

Closed jumper location for stiffness at a time

Smart accessories

Flexible test solutions from individual insulated test adapter to test connectors for complete assemblies testing.

- Direct plug-in into jumpers channels
- 5, 6, 8 mm spacing, mixing various spacing is possible
- 1000 V rating.

Component holder plugs for series or parallel component mounting (resistors, filters, diodes..).

Can be installed after wiring.

Series plug offers screwless component connection (no soldering).



Plug-in individual test adapter

Plug-in test connector



Series plug associated with disconnect blocks

Parallel plug to be installed between 2 blocks

Smart plug-in jumpers:

Pre-cut poles removable by hand: clean cut.

Insulated up to 1000 V (avoid use of separators).

Predefined shapes in molding to easily identify connected poles with a pen.

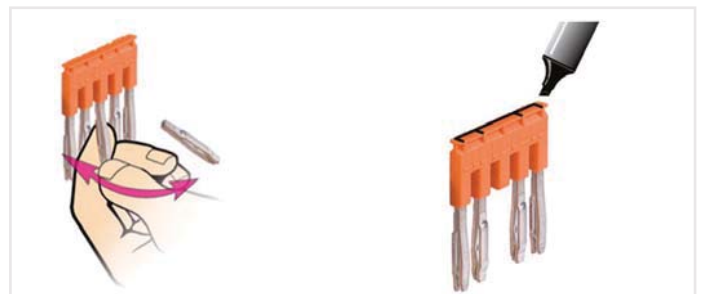

Pre-cut poles easy removable by hand

Predefined shape to identify connected poles

Screw clamp technology - SNK series, terminal blocks

Features and benefits

Optimized logistics

Reduce your accessories inventory by up to 50%

SNK PI-Spring, screw and pluggable ranges share the same accessories.

Reduced packaging adapted to the usage (20 items packaging for some references).

All end sections and circuit separators fit several types and sizes of blocks.

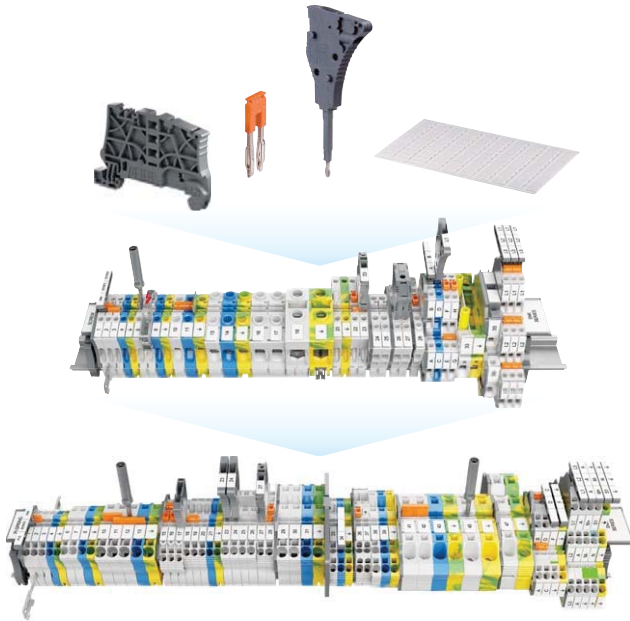

Shared accessories for SNK PI-Spring, screw and pluggable ranges

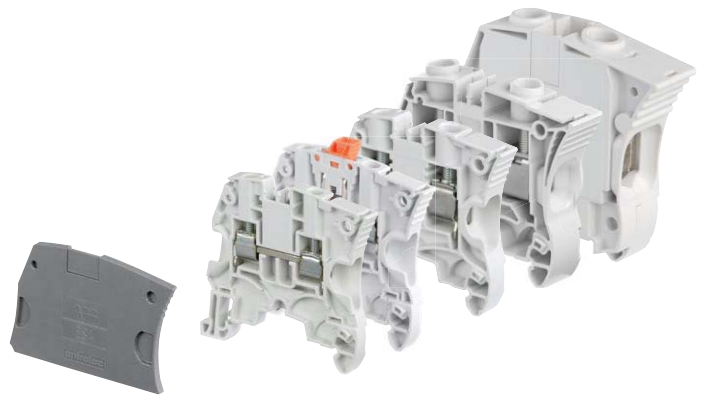

Stock only one end section for managing your assembly up to 240 mm²

Facilitate maintenance operations

Terminals can be individually removed from a terminal assembly equipped with markers:

TE Connectivity markers become independent after strip mounting, TE Connectivity markers remain on terminal in any situation.

Reliable in harsh conditions

Qualified for worldwide markets, applications and for severe environments: vibration, shock, corrosion...

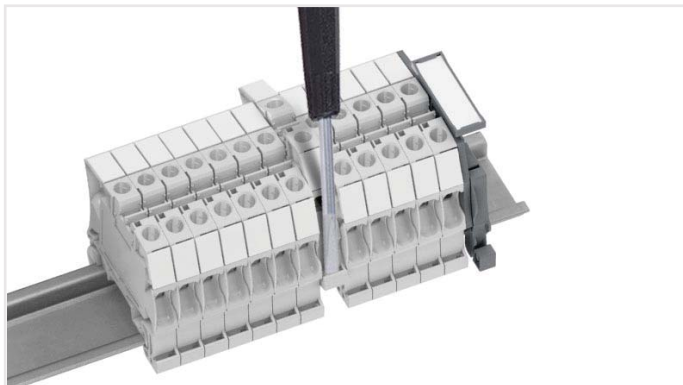

Maintenance operations facilitated



SNK series, terminal blocks

Screw clamp technology - Range overview from 4 to 240 mm² - 10 to 500 Kcmil



Connections

Single deck

Feed-through
Ground
Disconnect
Fuse



Connections

Single deck

Feed-through
Ground



Connections

Single deck

Feed-through
Ground
Disconnect

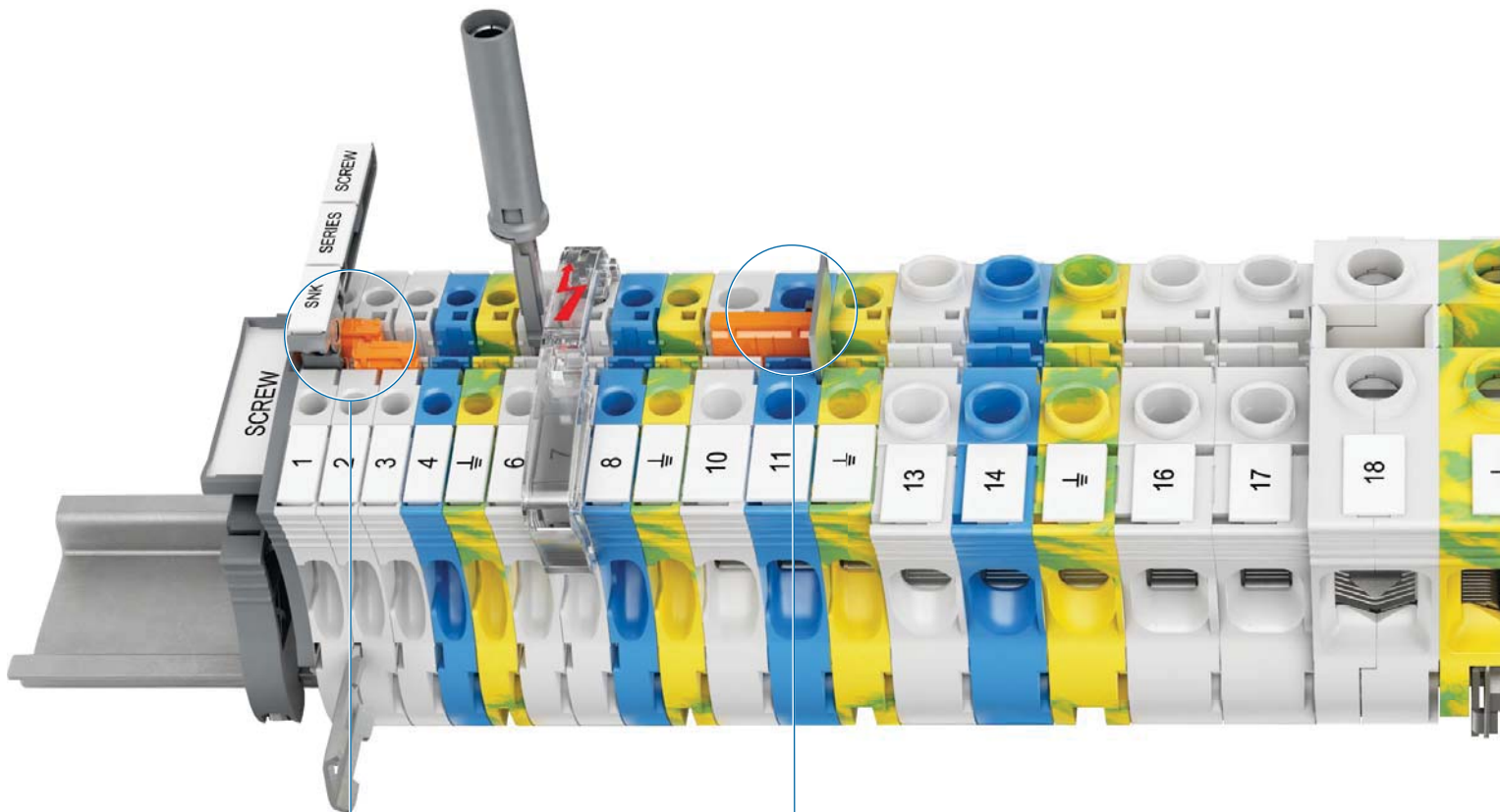

Double central channels
allows multiconfigurations
(jumping, testing and
measuring)

Circuit separator
without spacing loss

2x2  Connections

- Double deck
- Feed-through
- Ground
- Disconnect
- Fuse
- Component holder

2  Connections

- Test and measurement
- Feed-through
- Ground
- Disconnect

3x2  Connections

- Triple deck
- Feed-through

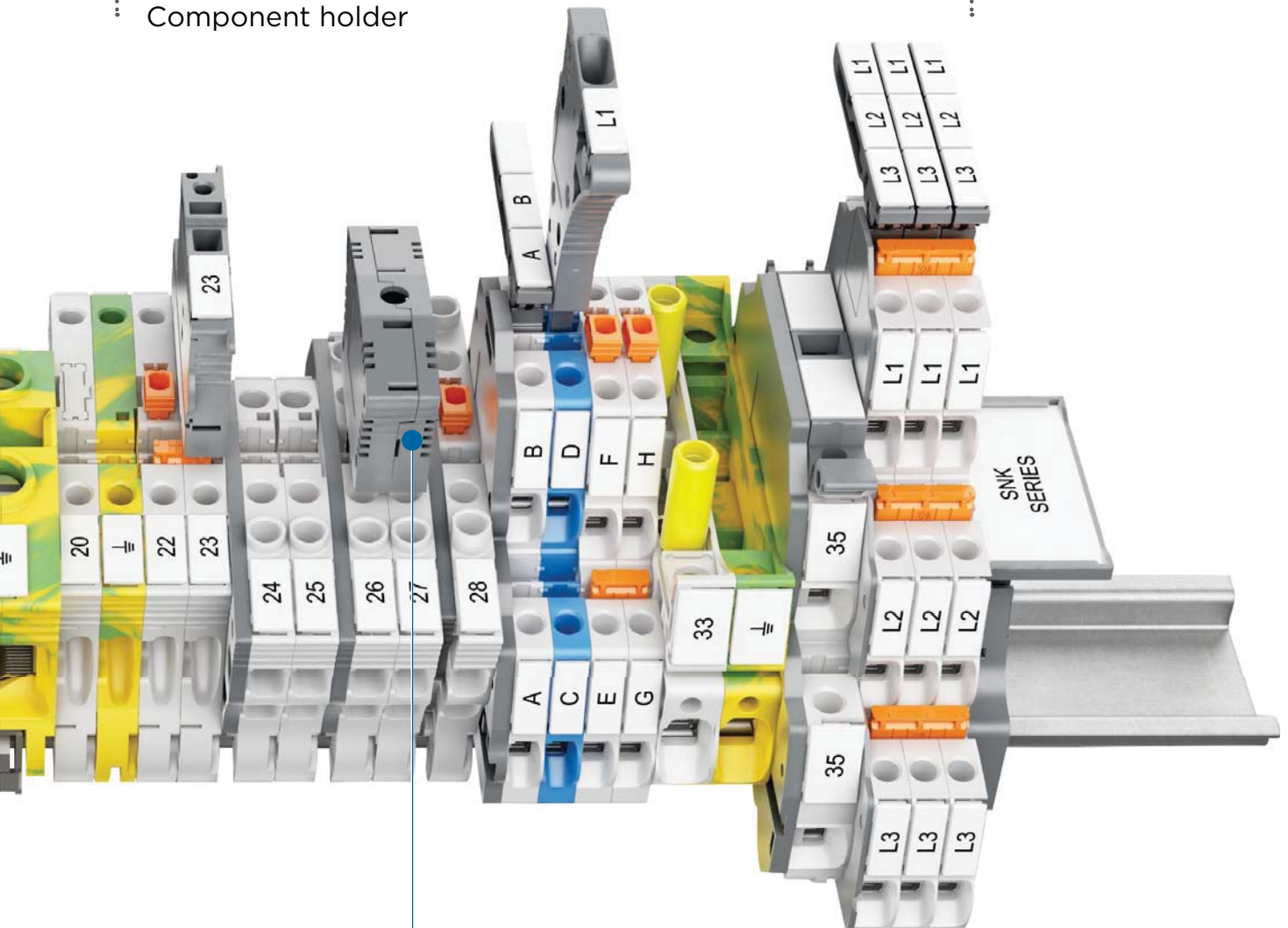

Plug
component holder

SNK series, terminal blocks

Screw clamp technology



Feed-through

Ground

Section									
4 mm ²	12 AWG 10 AWG	ZS4				ZS4-PE			
6 mm ²	10 AWG	ZS6	ZS6-3S	ZS6-4S		ZS6-PE	ZS6-3S-PE	ZS6-4S-PE	
10 mm ²	6 AWG	ZS10				ZS10-PE			
16 mm ²	4 AWG	ZS16				ZS16-PE			
25 mm ²	3 AWG	ZS25				ZS25-PE			
35 mm ²	0 AWG				ZS35				ZS35-PE
50 mm ²	0 AWG				ZS50				ZS50-PE
70 mm ²	00 AWG				ZS70				ZS70-PE
95 mm ²	0000 AWG				ZS95				ZS95-PE
150 mm ²	350 Kcmil					ZS150			
240 mm ²	500 Kcmil					ZS240			



Disconnect with blade

Disconnect with plug

Section											
4 mm ²	10 AWG	ZS4-S	ZS4-S-T2		ZS4-S-R1	ZS4-S-T2-R1	ZS4-S-T2.3-R1	ZS4-SP	ZS4-SP-T2	ZS4-SP-R1	ZS4-SP-T2-R1
6 mm ²	10 AWG	ZS6-S		ZS6-S-4S-T2							
10 mm ²	6 AWG	ZS10-S						ZS10-SP			



For 5 x 20 mm fuses

Aligned for marshalling cabinets application

For 6.3 x 32 mm fuses (¼ x 1¼ in)

Aligned

Section										
4 mm ²	10 AWG	ZS4-SF	ZS4-SF-T2	ZS4-SF-R1	ZS4-SF-R2	ZS4-R2	ZS4-PE-R2	ZS4-S-R2		
				ZS4-SF-R3	ZS4-SF-R4					
10 mm ²	6 AWG							ZS10-SF	ZS10-SF-R1	ZS10-S-R2
									ZS10-SF-R3	

Clamp -
 Channels for jumpering or testing -
 Test socket -
 Blown-fuse indicator



Double deck								Triple deck		
Feed-through		Ground		Disconnect with blade		For 5 x 20 mm and 5 x 25 mm fuses		Component holder		Feed-through
ZS4-D2	ZS4-D1	ZS6-D2-PE	ZS6-D1-PE	ZS4-D2-S	ZS4-D2-S-T2	ZS4-D2-SF1	ZS4-D2-SF1-R1 ZS4-D2-SF-R3	ZS4-D-CH-UD	ZS4-D-CH-DU	ZS4-T3 ZS4-T3-R1



Test & measurement			
Test disconnect with sliding link		Aligned with ZS10-ST	
ZS10-ST	ZS10-ST-T4 ZS10-ST-1	ZS10-R1	ZS10-PE-R1



For 5 x 20 mm and 5 x 25 mm fuses				Feed-through aligned with ZS4-SF1	
ZS4-SF1	ZS4-SF1-T2	ZS4-SF1-R1 ZS4-SF1-R3	ZS4-SF1-R2 ZS4-SF1-R4	ZS4-R1	ZS4-S-R3

ZS4 screw clamp terminal blocks

Feed-through - 5.2 mm 0.205 in spacing



1SNK161001E0014

ZS4

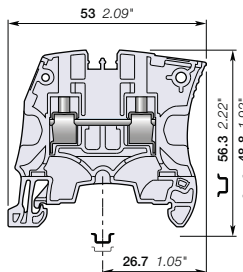

5.2 mm 0.205 in spacing

Description

- Save space by connecting conductors up to 4 mm² (without insulated ferrule, CB certified) 12 AWG in just 5.2 mm 0.205 in spacing,
- Perfectly adapted to solar applications: voltage is rated 1000 V AC / DC IEC.

Ordering details

Description	Color	Type	Part Number	Pkg qty	Weight (1 pce) g
Feed-through	Grey	ZS4	1SNK505010R0000	50	8.80
	Blue	ZS4-BL	1SNK505020R0000	50	8.80
	Orange	ZS4-OR	1SNK505030R0000	50	8.80
	Yellow	ZS4-YL	1SNK505060R0000	50	8.80
	Green	ZS4-GN	1SNK505061R0000	50	8.80
	Red	ZS4-RD	1SNK505062R0000	50	8.80
	Purple	ZS4-PR	1SNK505063R0000	50	8.80
	Brown	ZS4-BR	1SNK505064R0000	50	8.80
	White	ZS4-WH	1SNK505065R0000	50	8.80
	Black	ZS4-BK	1SNK505066R0000	50	8.80

Main technical data

Connecting capacity	IEC	UL - CSA	Mounting instructions		
1 conductor per clamp	Rigid: Solid/Stranded	0.2 ... 4 mm ²	24 ... 12 AWG	Rail	TH 35-7.5, TH 35-15
	Flexible without ferrule	0.22 ... 4 mm ²	24 ... 12 AWG	Wire stripping length	10.5 mm 0.412 in
	Flexible with non insulated ferrule	0.22 ... 4 mm ²	24 ... 12 AWG	Tool	Flat screwdriver Ø 3.5 mm Ø 0.138 in
	Flexible with insulated ferrule	0.22 ... 2.5 mm ²	24 ... 14 AWG		
	Gauge	A3-B3		Torque	0.6 Nm ± 0.1 5.31 lb.in ± 0.885
2 conductors per clamp	Rigid: Solid/Stranded	0.2 ... 1.5 mm ²	24 ... 16 AWG		
	Flexible without ferrule	0.2 ... 1.5 mm ²	24 ... 16 AWG		
	Flexible with twin ferrule	0.22 ... 1.5 mm ²	20 A / 12 AWG		
Rated current / Rated cross section		32 A / 4 mm ²			
Rated short-time withstand current (1s)		480 A			
Short Circuit Current Rating (with specific conditions)			100 kA		
Rated voltage		1000 V	600 V		
Impulse withstand voltage		8000 V			
Protection		IP20	NEMA 1		
Increased safety Ex e		693 V 32 A IEC/EN 60079-7 - IM2 II 2 GD Ex eb I/IIIC - 600 V 20 A UL 60079-7 - Class I, Zone 1, AEx e II, Ex e II U			

The connecting capacity data for one Rigid: Solid/Stranded, or one Flexible conductor (when applicable) is a mandatory information required by IEC, UL and CSA standards (Copper conductors). All other data are provided as supplementary information only. For more details, please consult our CB, UL or CSA certificates and technical datasheet available on <http://www.TE.com>



Accessories

Description	Color	Type	Part Number	Pkg qty	Weight (1 pce) g	
1 End stops	Dark grey	BAM4	1SNK900001R0000	50	14.00	
2 End sections	Dark grey	ES4	1SNK505910R0000	20	2.20	
3 Jumper bars	Orange	2 poles	JB5-2	1SNK905302R0000	50	1.30
		3 poles	JB5-3	1SNK905303R0000	50	2.00
		4 poles	JB5-4	1SNK905304R0000	50	2.70
		5 poles	JB5-5	1SNK905305R0000	50	3.50
		10 poles	JB5-10	1SNK905310R0000	30	7.10
50 poles	JB5-50	1SNK905350R0000	10	36.00		
4 Cross spacing jumpers	Orange	JB85-3	1SNK900603R0000	10	2.80	
5 Circuit separators	Dark grey	0 mm	CS	1SNK900101R0000	20	0.20
		3 mm	CS-R1	1SNK900103R0000	20	5.20
6 Test adapters	Dark grey	For test plugs DIA 2 mm 0.079 in	TP2	1SNK900203R0000	20	1.70
		For test plugs DIA 4 mm 0.157 in	TP4	1SNK900205R0000	20	2.40
7 Test connectors	Dark grey	5.2 mm 0.205 in spacing	TC5	1SNK900200R0000	10	5.20
		End module, 5.2 mm 0.205 in	TC5-R1	1SNK900201R0000	10	5.20
8 Shield connectors		SHBS	1SNK900600R0000	20	3.50	
9 Protecting covers	Transparent	5.2 mm 0.205 in spacing	PL5	1SNK900618R0000	10	1.50
			MG-CPM 13 41790	1SNB041790R0512	1960	0.23
10 Terminal block markers	White	Blank marker	MC512	1SNK140000R0000	22	9.00
		Blank card	MC512PA	1SNK149999R0000	20	10.00
		Universal wire markers holder	UMH	1SNK900611R0000	10	0.20

Complete list of accessories is indicated in the terminal block datasheet including end stops.

Some accessories such as jumper bars may modify the terminal block's ratings: Complete information available in the accessories section of the catalog.

Ground screw clamp terminal blocks

Description	Color	Type	Part Number	Pkg qty	Weight (1 pce) g
Ground	Green-yellow	ZS4-PE	1SNK505150R0000	20	12.10

Technical data valid for copper conductors only.

ZS6 screw clamp terminal blocks

Feed-through - 6 mm 0.236 in spacing



ZS6

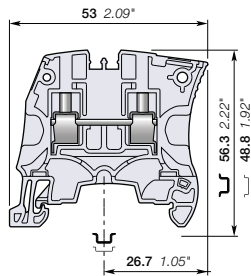

6 mm 0.236 in spacing

Description

Save space by connecting conductors up to 6 mm² (without insulated ferrule, CB certified) 10 AWG in just 6 mm 0.236 in spacing,

– Perfectly adapted to solar applications: voltage is rated 1000 V AC / DC IEC.

Ordering details

Description	Color	Type	Part Number	Pkg qty	Weight (1 pce) g
Feed-through	Grey	ZS6	1SNK506010R0000	50	10.60
	Blue	ZS6-BL	1SNK506020R0000	50	10.60
	Orange	ZS6-OR	1SNK506030R0000	50	10.60
	Yellow	ZS6-YL	1SNK506060R0000	50	10.60
	Green	ZS6-GN	1SNK506061R0000	50	10.60
	Red	ZS6-RD	1SNK506062R0000	50	10.60
	Purple	ZS6-PR	1SNK506063R0000	50	10.60
	Brown	ZS6-BR	1SNK506064R0000	50	10.60
	White	ZS6-WH	1SNK506065R0000	50	10.60
	Black	ZS6-BK	1SNK506066R0000	50	10.60

Main technical data

Connecting capacity	IEC	UL - CSA	Rail	Wire stripping length	TH 35-7.5, TH 35-15
1 conductor per clamp	Rigid: Solid/Stranded	0.2 ... 6 mm ²	24 ... 10 AWG	10.5 mm 0.412 in	Flat screwdriver Ø 4 mm Ø 0.157 in
	Flexible without ferrule	0.2 ... 6 mm ²	24 ... 12 AWG		
	Flexible with non insulated ferrule	0.22 ... 4 mm ²	24 ... 12 AWG		
	Flexible with insulated ferrule	0.22 ... 4 mm ²	24 ... 12 AWG		
	Gauge	A4-B3			
2 conductors per clamp	Rigid: Solid/Stranded	0.2 ... 2.5 mm ²	24 ... 14 AWG	Torque	0.85 Nm ± 0.15 7.52 lb.in ± 1.33
	Flexible without ferrule	0.2 ... 2.5 mm ²	24 ... 14 AWG		
	Flexible with twin ferrule	0.22 ... 2.5 mm ²	24 ... 14 AWG		
Rated current / Rated cross section	41 A / 6 mm ²	30 A / 10 AWG			
Rated short-time withstand current (1s)	720 A				
Short Circuit Current Rating (with specific conditions)		100 kA			
Rated voltage	1000 V	600 V			
Impulse withstand voltage	8000 V				
Protection	IP20	NEMA 1			

Increased safety Ex e 693 V 41 A IEC/EN 60079-7 - IM2 II 2 GD Ex eb I/II/III - 600 V 30 A UL 60079-7 - Class I, Zone 1, AEx e II, Ex e II U

The connecting capacity data for one Rigid: Solid/Stranded, or one Flexible conductor (when applicable) is a mandatory information required by IEC, UL and CSA standards (Copper conductors). All other data are provided as supplementary information only. For more details, please consult our CB, UL or CSA certificates and technical datasheet available on <http://www.TE.com>

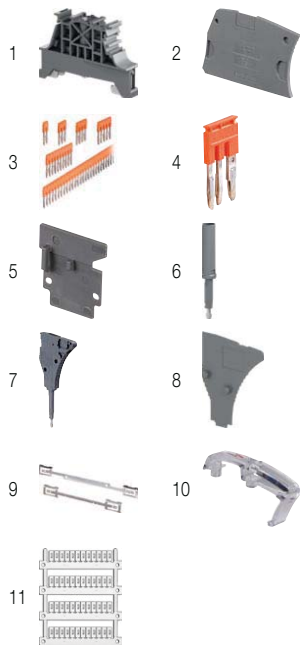

Accessories

Description	Color	Type	Part Number	Pkg qty	Weight (1 pce) g	
1 End stops	Dark grey	BAM4	1SNK900001R0000	50	14.00	
2 End sections	Dark grey	ES4	1SNK505910R0000	20	2.20	
3 Jumper bars	Orange	2 poles	JB6-2	1SNK906302R0000	50	1.30
		3 poles	JB6-3	1SNK906303R0000	50	2.10
		4 poles	JB6-4	1SNK906304R0000	50	2.90
		5 poles	JB6-5	1SNK906305R0000	50	3.60
		10 poles	JB6-10	1SNK906310R0000	20	7.40
		50 poles	JB6-50	1SNK906350R0000	10	38.10
4 Cross spacing jumpers	Orange	JB85-3	1SNK900603R0000	10	2.80	
5 Circuit separators	Dark grey	0 mm	CS	1SNK900101R0000	20	0.20
		3 mm	CS-R1	1SNK900103R0000	20	5.20
6 Test adapters	Dark grey	For test plugs DIA 2 mm 0.079 in	TP2	1SNK900203R0000	20	1.70
		For test plugs DIA 4 mm 0.157 in	TP4	1SNK900205R0000	20	2.40
7 Test connectors	Dark grey	TC5-R1	1SNK900201R0000	10	5.20	
8 Spacers	Dark grey	ES-TC6	1SNK900105R0000	10	0.80	
9 Shield connectors		SHBS	1SNK900600R0000	20	3.50	
10 Protecting covers	Transparent	PL6	1SNK900619R0000	10	1.80	
11 Terminal block markers	White	Blank marker	MG-CPM 13 41791	1680	0.27	
		Blank card	MC612	1SNK150000R0000	22	10.00
		Universal wire markers holder	UMH	1SNK900611R0000	10	0.20

Complete list of accessories is indicated in the terminal block datasheet including end stops.

Some accessories such as jumper bars may modify the terminal block's ratings: Complete information available in the accessories section of the catalog.

Ground screw clamp terminal blocks

Description	Color	Type	Part Number	Pkg qty	Weight (1 pce) g
Ground	Green-yellow	ZS6-PE	1SNK506150R0000	20	13.70



Technical data valid for copper conductors only.

ZS6-3S screw clamp terminal blocks

Feed-through with 3 connections - 6 mm 0.236 in spacing



1SNK1610750014

ZS6-3S

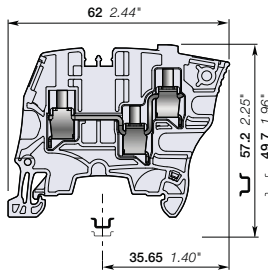

6 mm 0.236 in spacing

Description

- Recommended for energy markets and highly demanding applications requiring that only one conductor be connected per clamp,
- These blocks offer a high density connecting capacity (up to 3 connections) in a low profile and just 6 mm 0.236 in spacing.

Ordering details

Description	Color	Type	Part Number	Pkg qty	Weight (1 pce) g
Feed-through	Grey	ZS6-3S	1SNK506011R0000	50	11.80
	Blue	ZS6-3S-BL	1SNK506021R0000	50	11.80
	Yellow	ZS6-3S-YL	1SNK506067R0000	50	11.80

Main technical data

Connecting capacity		IEC	UL - CSA	Mounting instructions	
1 conductor per clamp	Rigid: Solid/Stranded	0.2 ... 6 mm ²	24 ... 10 AWG	Rail	TH 35-7.5, TH 35-15
	Flexible without ferrule	0.22 ... 6 mm ²		Wire stripping length	10.5 mm
	Flexible with non insulated ferrule	0.22 ... 4 mm ²	24 ... 12 AWG		0.413 in
	Flexible with insulated ferrule	0.22 ... 4 mm ²	24 ... 12 AWG		
2 conductors per clamp	Gauge	A4-B3		Tool	Flat screwdriver Ø 4 mm Ø 0.157 in
	Rigid: Solid/Stranded	0.2 ... 2.5 mm ²	24 ... 14 AWG		
	Flexible without ferrule	0.2 ... 2.5 mm ²			
	Flexible with twin ferrule	0.22 ... 2.5 mm ²	24 ... 14 AWG	Torque	0.75 Nm ± 0.05 6.64 lb.in ± 0.443
	Rated current / Rated cross section	32 A / 4 mm ²	30 A / 10 AWG		
	Maximum current / Maximum cross section	39 A / 6 mm ²			
	Rated short-time withstand current (1s)	480 A			
	Short Circuit Current Rating (with specific conditions)		100 kA		
	Rated voltage	800 V	600 V		
	Impulse withstand voltage	8000 V			
	Protection	IP20	NEMA 1		
	Increased safety Ex e	550 V 29 A IEC/EN 60079-7 - IM2 II 2 GD Ex eb III/IIIC - 600 V 30 A			

The connecting capacity data for one Rigid: Solid/Stranded, or one Flexible conductor (when applicable) is a mandatory information required by IEC, UL and CSA standards (Copper conductors). All other data are provided as supplementary information only. For more details, please consult our CB, UL or CSA certificates and technical datasheet available on <http://www.TE.com>



Accessories

Description	Color	Type	Part Number	Pkg qty	Weight (1 pce) g	
1 End stops	Dark grey	BAM4	1SNK900001R0000	50	14.00	
2 End sections	Dark grey	ES6-3S	1SNK505912R0000	20	2.50	
3 Jumper bars	Orange	2 poles	JB6-2	1SNK906302R0000	50	1.30
		3 poles	JB6-3	1SNK906303R0000	50	2.10
		4 poles	JB6-4	1SNK906304R0000	50	2.90
		5 poles	JB6-5	1SNK906305R0000	50	3.60
		10 poles	JB6-10	1SNK906310R0000	20	7.40
50 poles	JB6-50	1SNK906350R0000	10	38.10		
4 Cross spacing jumpers	Orange	JB85-3	1SNK900603R0000	10	2.80	
5 Circuit separators	Dark grey	0 mm	CS	1SNK900101R0000	20	0.20
		3 mm	CS-R1	1SNK900103R0000	20	5.20
6 Test adapters	Dark grey	For test plugs DIA 2 mm 0.079 in	TP2	1SNK900203R0000	20	1.70
		For test plugs DIA 4 mm 0.157 in	TP4	1SNK900205R0000	20	2.40
7 Test connectors	Dark grey	TC5-R1	1SNK900201R0000	10	5.20	
8 Spacers	Dark grey	ES-TC6	1SNK900105R0000	10	0.80	
9 Terminal block markers	White	Blank marker	MG-CPM 13 41791	1SNB041791R0612	1680	0.27
		Blank card	MC612	1SNK150000R0000	22	10.00
			MC612PA	1SNK159999R0000	20	11.00
		Universal wire markers holder	Grey	UMH	1SNK900611R0000	10

Complete list of accessories is indicated in the terminal block datasheet including end stops.

Some accessories such as jumper bars may modify the terminal block's ratings: Complete information available in the accessories section of the catalog.

Ground screw clamp terminal blocks

Description	Color	Type	Part Number	Pkg qty	Weight (1 pce) g
Ground	Green-yellow	ZS6-3S-PE	1SNK506151R0000	25	16.20

Technical data valid for copper conductors only.

ZS6-4S screw clamp terminal blocks

Feed-through with 4 connections - 6 mm 0.236 in spacing



ZS6-4S

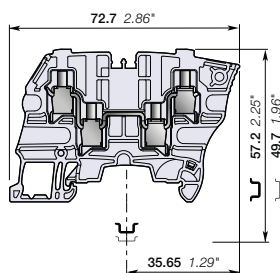

6 mm 0.236 in spacing

Description

- High density wiring (one potential distribution on 4 independent screw clamps) in a very low profile and just 6 mm 0.236 in spacing,
- Recommended for energy markets and highly demanding applications requiring that only one conductor be connected per clamp.

Ordering details

Description	Color	Type	Part Number	Pkg qty	Weight (1 pce) g
Feed-through	Grey	ZS6-4S	1SNK506012R0000	50	15.00
	Blue	ZS6-4S-BL	1SNK506022R0000	50	15.00
	Yellow	ZS6-4S-YL	1SNK506068R0000	50	15.00

Main technical data

Connecting capacity		IEC	UL - CSA	Mounting instructions	
1 conductor per clamp	Rigid: Solid/Stranded	0.2 ... 6 mm ²	24 ... 10 AWG	Rail	TH 35-7.5, TH 35-15
	Flexible without ferrule	0.22 ... 6 mm ²		Wire stripping length	10.5 mm 0.413 in
	Flexible with non insulated ferrule	0.22 ... 4 mm ²	24 ... 12 AWG	Tool	Flat screwdriver Ø 4 mm Ø 0.157 in
	Flexible with insulated ferrule	0.22 ... 4 mm ²	24 ... 12 AWG		
Gauge		A4-B3		Torque	0.75 Nm ± 0.05 6.64 lb.in ± 0.443
2 conductors per clamp	Rigid: Solid/Stranded	0.2 ... 2.5 mm ²	24 ... 14 AWG		
	Flexible without ferrule	0.2 ... 2.5 mm ²			
	Flexible with twin ferrule	0.22 ... 2.5 mm ²	24 ... 14 AWG		
Rated current / Rated cross section		32 A / 4 mm ²	30 A / 10 AWG		
Maximum current / Maximum cross section		39 A / 6 mm ²			
Rated short-time withstand current (1s)		480 A			
Short Circuit Current Rating (with specific conditions)			100 kA		
Rated voltage		800 V	600 V		
Impulse withstand voltage		8000 V			
Protection		IP20	NEMA 1		
Increased safety Ex e		550 V 29 A IEC/EN 60079-7 - IM2 II 2 GD Ex eb I/II/IIIc - 600 V 30 A			

The connecting capacity data for one Rigid: Solid/Stranded, or one Flexible conductor (when applicable) is a mandatory information required by IEC, UL and CSA standards (Copper conductors). All other data are provided as supplementary information only. For more details, please consult our CB, UL or CSA certificates and technical datasheet available on <http://www.TE.com>



Accessories

Description	Color	Type	Part Number	Pkg qty	Weight (1 pce) g	
1 End stops	Dark grey	BAM4	1SNK900001R0000	50	14.00	
2 End sections	Dark grey	ES6-4S	1SNK505911R0000	20	3.10	
3 Jumper bars	Orange	2 poles	JB6-2	1SNK906302R0000	50	1.30
		3 poles	JB6-3	1SNK906303R0000	50	2.10
		4 poles	JB6-4	1SNK906304R0000	50	2.90
		5 poles	JB6-5	1SNK906305R0000	50	3.60
		10 poles	JB6-10	1SNK906310R0000	20	7.40
		50 poles	JB6-50	1SNK906350R0000	10	38.10
4 Cross spacing jumpers	Orange	JB85-3	1SNK900603R0000	10	2.80	
5 Circuit separators	Dark grey	0 mm	CS	1SNK900101R0000	20	0.20
		3 mm	CS-R1	1SNK900103R0000	20	5.20
6 Test adapters	Dark grey	For test plugs DIA 2 mm 0.079 in	TP2	1SNK900203R0000	20	1.70
		For test plugs DIA 4 mm 0.157 in	TP4	1SNK900205R0000	20	2.40
		End module, 5.2 mm 0.205 in	TC5-R1	1SNK900201R0000	10	5.20
8 Spacers	Dark grey	ES-TC6	1SNK900105R0000	10	0.80	
9 Terminal block markers	White	Blank marker	MG-CPM 13 41791	1SNB041791R0612	1680	0.27
		Blank card	MC612	1SNK150000R0000	22	10.00
			MC612PA	1SNK159999R0000	20	11.00
			Universal wire markers holder	Grey	UMH	1SNK900611R0000

Complete list of accessories is indicated in the terminal block datasheet including end stops. Some accessories such as jumper bars may modify the terminal block's ratings: Complete information available in the accessories section of the catalog.

Ground screw clamp terminal blocks

Description	Color	Type	Part Number	Pkg qty	Weight (1 pce) g
Ground	Green-yellow	ZS6-4S-PE	1SNK506152R0000	25	19.40

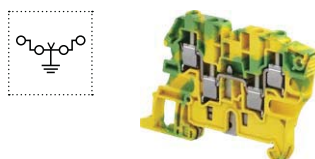

Technical data valid for copper conductors only.

ZS10 screw clamp terminal blocks

Feed-through - 8 mm 0.315 in spacing

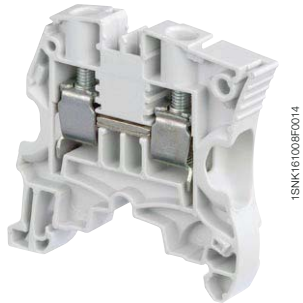

ZS10

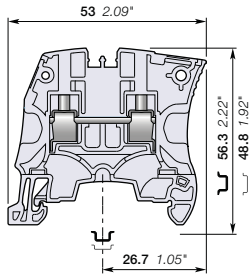

8 mm 0.315 in spacing

Description

- Save space by connecting conductors up to 10 mm² (without insulated ferrule, CB certified) 6 AWG in just 8 mm 0.315 in spacing,
- Perfectly adapted to solar applications: voltage is rated 1000 V AC / DC IEC.

Ordering details

Description	Color	Type	Part Number	Pkg qty	Weight (1 pce) g
Feed-through	Grey	ZS10	1SNK508010R0000	50	14.10
	Blue	ZS10-BL	1SNK508020R0000	50	14.10
	Orange	ZS10-OR	1SNK508030R0000	50	14.10
	Yellow	ZS10-YL	1SNK508060R0000	50	14.10
	Green	ZS10-GN	1SNK508061R0000	50	14.10
	Red	ZS10-RD	1SNK508062R0000	50	14.10
	Purple	ZS10-PR	1SNK508063R0000	50	14.10
	Brown	ZS10-BR	1SNK508064R0000	50	14.10
	White	ZS10-WH	1SNK508065R0000	50	14.10
	Black	ZS10-BK	1SNK508066R0000	50	14.10

Main technical data

Connecting capacity		IEC	UL - CSA	Mounting instructions	
1 conductor per clamp	Rigid: Solid/Stranded	0.5 ... 10 mm ²	24 ... 6 AWG	Rail	TH 35-7.5, TH 35-15
	Flexible without ferrule	0.5 ... 10 mm ²		Wire stripping length	12 mm 0.472 in
	Flexible with non insulated ferrule	0.5 ... 10 mm ²	24 ... 8 AWG	Tool	Flat screwdriver Ø 4 mm Ø 0.157 in
	Flexible with insulated ferrule	0.5 ... 6 mm ²	24 ... 10 AWG		
	Gauge	A5-B5		Torque	1.3 Nm ± 0.3 11.5 lb.in ± 2.65
2 conductors per clamp	Rigid: Solid/Stranded	0.5 ... 4 mm ²	20 ... 12 AWG		
	Flexible without ferrule	0.5 ... 4 mm ²			
	Flexible with twin ferrule	0.5 ... 4 mm ²	20 ... 12 AWG		
Rated current / Rated cross section		57 A / 10 mm ²	42 A / 6 AWG		
Rated short-time withstand current (1s)		1200 A			
Short Circuit Current Rating (with specific conditions)			100 kA		
Rated voltage		1000 V	600 V		
Impulse withstand voltage		8000 V			
Protection		IP20	NEMA 1		

Increased safety Ex e 693 V 57 A IEC/EN 60079-7 - IM2 II 2 GD Ex eb III/IIIC - 600 V 42 A UL 60079-7 - Class I, Zone 1, AEx e II, Ex e II U

The connecting capacity data for one Rigid: Solid/Stranded, or one Flexible conductor (when applicable) is a mandatory information required by IEC, UL and CSA standards (Copper conductors). All other data are provided as supplementary information only. For more details, please consult our CB, UL or CSA certificates and technical datasheet available on <http://www.TE.com>



Accessories

Description	Color	Type	Part Number	Pkg qty	Weight (1 pce) g	
1 End stops	Dark grey	BAM4	1SNK900001R0000	50	14.00	
2 End sections	Dark grey	ES4	1SNK505910R0000	20	2.20	
3 Jumper bars	Orange	2 poles	JB8-2	1SNK908302R0000	50	2.70
		3 poles	JB8-3	1SNK908303R0000	50	4.10
		4 poles	JB8-4	1SNK908304R0000	50	5.60
		5 poles	JB8-5	1SNK908305R0000	40	7.00
		10 poles	JB8-10	1SNK908310R0000	20	14.20
4 Cross spacing jumpers	Orange	JB85-3	1SNK900603R0000	10	2.80	
5 Circuit separators	Dark grey	0 mm	CS	1SNK900101R0000	20	0.20
		3 mm	CS-R1	1SNK900103R0000	20	5.20
6 Test adapters	Dark grey	For test plugs DIA 2 mm 0.079 in	TP2	1SNK900203R0000	20	1.70
		For test plugs DIA 4 mm 0.157 in	TP4	1SNK900205R0000	20	2.40
7 Test connectors	Dark grey	5.2 mm 0.205 in spacing	TC5	1SNK900200R0000	10	5.20
		End module, 5.2 mm 0.205 in	TC5-R1	1SNK900201R0000	10	5.20
8 Spacers	Dark grey	ES-TC8	1SNK900104R0000	10	1.40	
9 Protecting covers	Transparent	PL8	1SNK900620R0000	10	2.60	
10 Terminal block markers	White	Blank marker	MG-CPM 13 41791	1SNB041791R0612	1680	0.27
		Blank card	MC812	1SNK160000R0000	22	10.00
			MC812PA	1SNK169999R0000	20	14.00
		Universal wire markers holder	Grey	UMH	1SNK900611R0000	10

Complete list of accessories is indicated in the terminal block datasheet including end stops.

Some accessories such as jumper bars may modify the terminal block's ratings: Complete information available in the accessories section of the catalog.

Ground screw clamp terminal blocks

Description	Color	Type	Part Number	Pkg qty	Weight (1 pce) g
Ground	Green-yellow	ZS10-PE	1SNK508150R0000	20	22.50

Technical data valid for copper conductors only.

ZS16 screw clamp terminal blocks

Feed-through - 10 mm 0.394 in spacing



ZS16

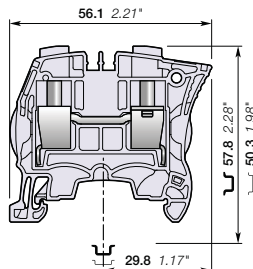

10 mm 0.394 in spacing

Description

- Save space by connecting conductors up to 16 mm² (without insulated ferrule, CB certified) 4 AWG in just 10 mm 0.394 in spacing,
- Perfectly adapted to solar applications: voltage is rated 1000 V AC / DC IEC.

Ordering details

Description	Color	Type	Part Number	Pkg qty	Weight (1 pce) g
Feed-through	Grey <input type="checkbox"/>	ZS16	1SNK510010R0000	25	20.20
	Blue <input type="checkbox"/>	ZS16-BL	1SNK510020R0000	25	20.20
	Orange <input type="checkbox"/>	ZS16-OR	1SNK510030R0000	25	20.20

Main technical data

Connecting capacity		IEC	UL - CSA	Mounting instructions	
1 conductor per clamp	Rigid: Solid/Stranded	0.5 ... 16 mm ²	24 ... 4 AWG	Rail	TH 35-7.5, TH 35-15
	Flexible without ferrule	0.5 ... 16 mm ²		Wire stripping length	13.5 mm 0.531 in
	Flexible with non insulated ferrule	0.5 ... 16 mm ²	24 ... 4 AWG		
	Flexible with insulated ferrule	0.5 ... 10 mm ²	24 ... 8 AWG		
	Gauge	A6-B6			
2 conductors per clamp	Rigid: Solid/Stranded	0.5 ... 6 mm ²	20 ... 10 AWG	Tool	Flat screwdriver Ø 5.5 mm Ø 0.217 in
	Flexible without ferrule	0.5 ... 6 mm ²	20 ... 10 AWG		
	Flexible with twin ferrule	0.5 ... 6 mm ²	20 ... 10 AWG		
Rated current / Rated cross section		76 A / 16 mm ²	67 A / 4 AWG	Torque	1.8 Nm ± 0.2 15.9 lb.in ± 1.77
Rated short-time withstand current (1s)		1920 A			
Short Circuit Current Rating (with specific conditions)			100 kA		
Rated voltage		1000 V	600 V		
Impulse withstand voltage		8000 V			
Protection		IP20	NEMA 1		
Increased safety Ex e		693 V 76 A IEC/EN 60079-7 - IM2 II 2 GD Ex eb I/IIIC - 600 V 67 A UL 60079-7 - Class I, Zone 1, AEx e II, Ex e II U			

The connecting capacity data for one Rigid: Solid/Stranded, or one Flexible conductor (when applicable) is a mandatory information required by IEC, UL and CSA standards (Copper conductors). All other data are provided as supplementary information only. For more details, please consult our CB, UL or CSA certificates and technical datasheet available on <http://www.TE.com>

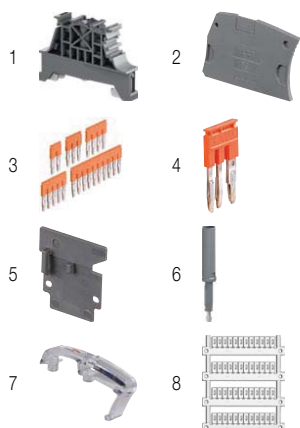

Accessories

Description	Color	Type	Part Number	Pkg qty	Weight (1 pce) g	
1 End stops	Dark grey <input type="checkbox"/>	BAM4	1SNK900001R0000	50	14.00	
2 End sections	Dark grey <input type="checkbox"/>	ES4	1SNK505910R0000	20	2.20	
3 Jumper bars	Orange <input type="checkbox"/>	2 poles	JB10-2	1SNK910302R0000	50	4.60
		3 poles	JB10-3	1SNK910303R0000	50	7.10
		4 poles	JB10-4	1SNK910304R0000	40	9.40
		5 poles	JB10-5	1SNK910305R0000	30	12.00
		10 poles	JB10-10	1SNK910310R0000	20	24.00
4 Cross spacing jumpers	Orange <input type="checkbox"/>	JB85-3	1SNK900603R0000	10	2.80	
5 Circuit separators	Dark grey <input type="checkbox"/>	0 mm	CS	1SNK900101R0000	20	0.20
		3 mm	CS-R1	1SNK900103R0000	20	5.20
6 Test adapters	Dark grey <input type="checkbox"/>	For test plugs DIA 2 mm 0.079 in	TP2	1SNK900203R0000	20	1.70
		For test plugs DIA 4 mm 0.157 in	TP4	1SNK900205R0000	20	2.40
7 Protecting covers	Transparent <input type="checkbox"/>	10 mm 0.394 in spacing	PL10	1SNK900621R0000	10	3.10
8 Terminal block markers	White <input type="checkbox"/>	Blank marker	MG-CPM 13 41791	1SNB041791R0612	1680	0.27
			MC812	1SNK160000R0000	22	10.00
			MC812PA	1SNK169999R0000	20	14.00
		Universal wire markers holder	Grey <input type="checkbox"/>	UMH	1SNK900611R0000	10

Complete list of accessories is indicated in the terminal block datasheet including end stops. Some accessories such as jumper bars may modify the terminal block's ratings: Complete information available in the accessories section of the catalog.

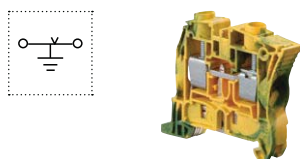

Ground screw clamp terminal blocks

Description	Color	Type	Part Number	Pkg qty	Weight (1 pce) g
Ground	Green-yellow <input type="checkbox"/>	ZS16-PE	1SNK510150R0000	20	32.00

Technical data valid for copper conductors only.

ZS25 screw clamp terminal blocks

Feed-through - 12 mm 0.472 in spacing



ZS25

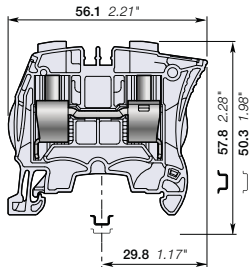

12 mm 0.472 in spacing

Description

- Save space by connecting conductors up to 25 mm² (without insulated ferrule, CB certified) 3 AWG in just 12 mm 0.472 in spacing,
- Perfectly adapted to solar applications: voltage is rated 1000 V AC / DC IEC.

Ordering details

Description	Color	Type	Part Number	Pkg qty	Weight (1 pce) g
Feed-through	Grey <input type="checkbox"/>	ZS25	1SNK512010R0000	25	21.40
	Blue <input type="checkbox"/>	ZS25-BL	1SNK512020R0000	25	21.40
	Yellow <input type="checkbox"/>	ZS25-YL	1SNK512060R0000	25	21.40

Main technical data

Connecting capacity		IEC	UL - CSA	Mounting instructions	
1 conductor per clamp	Rigid: Solid/Stranded	0.5 ... 25 mm ²	24 ... 3 AWG	Rail	TH 35-7.5, TH 35-15
	Flexible without ferrule	0.5 ... 25 mm ²		Wire stripping length	13.5 mm 0.531 in
	Flexible with non insulated ferrule	0.5 ... 16 mm ²	24 ... 4 AWG		
	Flexible with insulated ferrule	0.5 ... 16 mm ²	24 ... 8 AWG		
	Gauge	A6-B6			
2 conductors per clamp	Rigid: Solid/Stranded	0.5 ... 10 mm ²	20 ... 10 AWG	Tool	Flat screwdriver Ø 5.5 mm Ø 0.217 in
	Flexible without ferrule	0.5 ... 10 mm ²	20 ... 10 AWG		
	Flexible with twin ferrule	0.5 ... 10 mm ²	20 ... 10 AWG		
Rated current / Rated cross section		76 A / 16 mm ²	100 A / 3 AWG	Torque	1.8 Nm ± 0.2 15.9 lb.in ± 1.77
Maximum current / Maximum cross section		101 A / 25 mm ²			
Rated short-time withstand current (1s)		1920 A			
Short Circuit Current Rating (with specific conditions)			100 kA		
Rated voltage		1000 V	600 V		
Impulse withstand voltage		8000 V			
Protection		IP20	NEMA 1		
Increased safety Ex e		693 V 69 A IEC/EN 60079-7 - IM2 II 2 GD Ex eb I/II/IIIc - 600 V 100 A			

The connecting capacity data for one Rigid: Solid/Stranded, or one Flexible conductor (when applicable) is a mandatory information required by IEC, UL and CSA standards (Copper conductors). All other data are provided as supplementary information only. For more details, please consult our CB, UL or CSA certificates and technical datasheet available on <http://www.TE.com>



Accessories

Description	Color	Type	Part Number	Pkg qty	Weight (1 pce) g	
1 End stops 10 mm 0.394 in	Dark grey <input type="checkbox"/>	BAM4	1SNK900001R0000	50	14.00	
2 End sections 2.2 mm 0.087 in	Dark grey <input type="checkbox"/>	ES4	1SNK505910R0000	20	2.20	
3 Jumper bars 2 poles 76 A (IEC)	Orange <input type="checkbox"/>	JB12-2	1SNK912302R0000	50	4.90	
		3 poles 76 A (IEC)	JB12-3	1SNK912303R0000	50	7.60
		5 poles 76 A (IEC)	JB12-5	1SNK912305R0000	20	12.90
4 Cross spacing jumpers 3 poles 32 A (IEC)	Orange <input type="checkbox"/>	JB85-3	1SNK900603R0000	10	2.80	
5 Circuit separators 0 mm 0 in	Dark grey <input type="checkbox"/>	CS	1SNK900101R0000	20	0.20	
		3 mm 0.118 in	CS-R1	1SNK900103R0000	20	5.20
6 Test adapters For test plugs DIA 2 mm 0.079 in	Dark grey <input type="checkbox"/>	TP2	1SNK900203R0000	20	1.70	
		For test plugs DIA 4 mm 0.157 in	TP4	1SNK900205R0000	20	2.40
7 Protecting covers 10 mm 0.394 in spacing	Transparent <input type="checkbox"/>	PL10	1SNK900621R0000	10	3.10	
8 Terminal block markers	White <input type="checkbox"/>	MG-CPM 13 41791	1SNB041791R0612	1680	0.27	
		MC812	1SNK160000R0000	22	10.00	
		MC812PA	1SNK169999R0000	20	14.00	
		Universal wire markers holder	Grey <input type="checkbox"/>	UMH	1SNK900611R0000	10

Complete list of accessories is indicated in the terminal block datasheet including end stops. Some accessories such as jumper bars may modify the terminal block's ratings: Complete information available in the accessories section of the catalog.

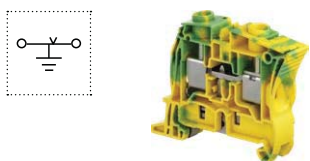
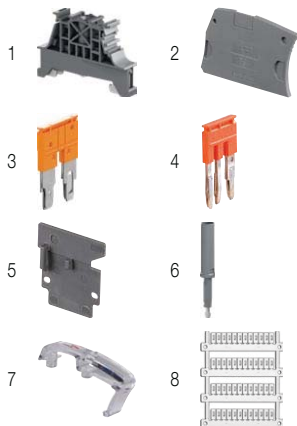

Ground screw clamp terminal blocks

Description	Color	Type	Part Number	Pkg qty	Weight (1 pce) g
Ground Profile aligned with ZS25	Green-yellow <input type="checkbox"/>	ZS25-PE	1SNK512150R0000	20	38.00

Technical data valid for copper conductors only.

ZS35 screw clamp terminal blocks

Feed-through - 16 mm 0.630 in spacing



ZS35

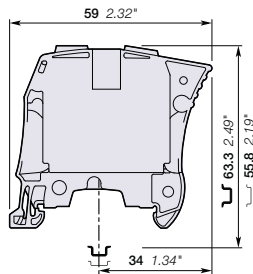

16 mm 0.630 in spacing

Description

Closed terminal block:

- No end section needed,
- Optimized rigidity,
- Perfectly adapted to solar applications: voltage is rated 1000 V AC / DC IEC.

Ordering details

Description	Color	Type	Part Number	Pkg qty	Weight (1 pce) g
Feed-through Closed block	Grey <input type="checkbox"/>	ZS35	1SNK516010R0000	20	53.40
	Blue <input type="checkbox"/>	ZS35-BL	1SNK516020R0000	20	53.40
	Orange <input type="checkbox"/>	ZS35-OR	1SNK516030R0000	20	53.40

Main technical data

Connecting capacity		IEC	UL - CSA	Mounting instructions	
1 conductor per clamp	Rigid: Solid/Stranded	6 ... 35 mm ²	10 ... 0 AWG	Rail	TH 35-7.5, TH 35-15
	Flexible without ferrule	6 ... 35 mm ²		Wire stripping length	17 mm 0.669 in
	Flexible with non insulated ferrule	4 ... 35 mm ²	10 ... 2 AWG		
	Flexible with insulated ferrule	4 ... 35 mm ²	10 ... 2 AWG		
	Gauge	A9-B9			
2 conductors per clamp	Rigid: Solid/Stranded	6 ... 16 mm ²	10 ... 6 AWG	Tool	Flat screwdriver Ø 6.5 mm Ø 0.256 in
	Flexible without ferrule	6 ... 16 mm ²			
	Flexible with twin ferrule	4 ... 10 mm ²	12 ... 8 AWG		
Rated current / Rated cross section		125 A / 35 mm ²	150 A / 0 AWG	Torque	2.9 Nm ± 0.1 25.7 lb.in ± 0.885
Rated short-time withstand current (1s)		4200 A			
Short Circuit Current Rating (with specific conditions)			100 kA		
Rated voltage		1000 V	600 V		
Impulse withstand voltage		8000 V			
Protection		IP10	NEMA 1		
Increased safety Ex e		693 V 125 A IEC/EN 60079-7 - IM2 II 2 GD Ex eb I/IIIC - 600 V 150 A UL 60079-7 - Class I, Zone 1, AEx e II			

The connecting capacity data for one Rigid: Solid/Stranded, or one Flexible conductor (when applicable) is a mandatory information required by IEC, UL and CSA standards (Copper conductors). All other data are provided as supplementary information only. For more details, please consult our CB, UL or CSA certificates and technical datasheet available on <http://www.TE.com>



Accessories

Description	Color	Type	Part Number	Pkg qty	Weight (1 pce) g	
1 End stops	Dark grey <input type="checkbox"/>	BAZH1	1SNK900102R0000	20	24.00	
2 Jumper bars	Orange <input type="checkbox"/>	10 mm 0.394 in	JB16-2	1SNK916302R0000	10	10.00
		2 poles 125 A (IEC)	JB16-3	1SNK916303R0000	10	16.00
		3 poles 125 A (IEC)	JB16-4	1SNK916304R0000	10	22.00
		4 poles 125 A (IEC)	JB16-5	1SNK916305R0000	10	28.00
		5 poles 125 A (IEC)	JB16-10	1SNK916310R0000	10	56.60
3 Circuit separators	Dark grey <input type="checkbox"/>	CS-R1	1SNK900103R0000	20	5.20	
4 Protecting covers	Transparent <input type="checkbox"/>	PL16	1SNK900622R0000	10	4.60	
5 Terminal block markers	White <input type="checkbox"/>	Blank marker	MG-CPM 13 41791	1SNB041791R0612	1680	0.27
		Blank card	MC812	1SNK160000R0000	22	10.00
		Universal wire markers holder	Grey <input type="checkbox"/>	UMH	1SNK900611R0000	20

Complete list of accessories is indicated in the terminal block datasheet including end stops. Some accessories such as jumper bars may modify the terminal block's ratings: Complete information available in the accessories section of the catalog.

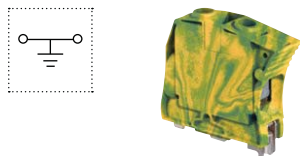

Ground screw clamp terminal blocks

Description	Color	Type	Part Number	Pkg qty	Weight (1 pce) g
Ground	Green-yellow <input type="checkbox"/>	ZS35-PE	1SNK516150R0000	20	81.80

Technical data valid for copper conductors only.

ZS50 screw clamp terminal blocks

Feed-through - 16 mm 0.630 in spacing



1SNK161084V0014

ZS50

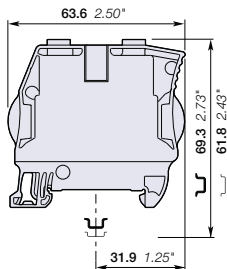

16 mm 0.630 in spacing

Description

Combine high performance with compact dimensions:

- Connect conductors up to 50 mm² (CB certified) 0 AWG in just 16 mm 0.630 in spacing,
- Perfectly adapted to solar applications: 1250 V DC (1000 V AC) IEC and 1000 V UL,
- Closed terminal block: no end section needed, optimized rigidity.

Ordering details

Description	Color	Type	Part Number	Pkg qty	Weight (1 pce) g
Feed-through Closed block	Grey <input type="checkbox"/>	ZS50	1SNK516011R0000	20	52.90
	Blue <input type="checkbox"/>	ZS50-BL	1SNK516021R0000	20	52.90
	Yellow <input type="checkbox"/>	ZS50-YL	1SNK516060R0000	20	52.90
	Red <input type="checkbox"/>	ZS50-RD	1SNK516063R0000	20	52.90
	Black <input type="checkbox"/>	ZS50-BK	1SNK516064R0000	20	52.90

Main technical data

Connecting capacity		IEC	UL - CSA	Rail		TH 35-7.5, TH 35-15
1 conductor per clamp	Rigid: Solid/Stranded	1 ... 50 mm ²	18 ... 0 AWG	Wire stripping length		17 mm 0.669 in
	Flexible without ferrule	1 ... 50 mm ²	18 ... 0 AWG			
	Flexible with non insulated ferrule	1 ... 50 mm ²	18 ... 0 AWG			
	Flexible with insulated ferrule	1 ... 50 mm ²	18 ... 0 AWG			
	Gauge	Dia. 11				
2 conductors per clamp	Rigid: Solid/Stranded	1 ... 25 mm ²	18 ... 4 AWG	Tool		Flat screwdriver Ø 6.5 mm Ø 0.256 in
	Flexible without ferrule	1 ... 25 mm ²	18 ... 4 AWG			
	Flexible with twin ferrule	1 ... 16 mm ²	18 ... 4 AWG			
Rated current / Rated cross section		150 A / 50 mm ²	140 A / 0 AWG	Torque		3 Nm ± 0.50 26.6 lb.in ± 4.43
Rated short-time withstand current (1s)		6000 A				
Short Circuit Current Rating (with specific conditions)			100 kA			
Rated voltage		1000 V	1000 V			
Impulse withstand voltage		8000 V				
Protection		IP10	NEMA 1			

Increased safety Ex e

880 V 150 A IEC/EN 60079-7 - IM2 II 2 GD Ex eb I/IIIC

The connecting capacity data for one Rigid: Solid/Stranded, or one Flexible conductor (when applicable) is a mandatory information required by IEC, UL and CSA standards (Copper conductors). All other data are provided as supplementary information only. For more details, please consult our CB, UL or CSA certificates and technical datasheet available on <http://www.TE.com>

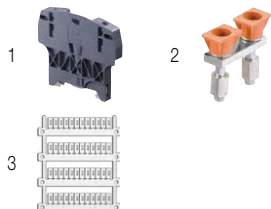

Accessories

Description	Color	Type	Part Number	Pkg qty	Weight (1 pce) g	
1 End stops	Dark grey <input type="checkbox"/>	BAZH1	1SNK900102R0000	20	24.00	
2 Jumper bars	Orange <input type="checkbox"/>	2 poles 125 A (IEC)	JB16-2	1SNK916302R0000	10	10.00
		3 poles 125 A (IEC)	JB16-3	1SNK916303R0000	10	16.00
		4 poles 125 A (IEC)	JB16-4	1SNK916304R0000	10	22.00
		5 poles 125 A (IEC)	JB16-5	1SNK916305R0000	10	28.00
		10 poles 125 A (IEC)	JB16-10	1SNK916310R0000	10	56.60
3 Terminal block markers	White <input type="checkbox"/>	Blank marker	MG-CPM 13 41791	1SNB041791R0612	1680	0.27
		Blank card	MC812	1SNK160000R0000	22	10.00
			MC812PA	1SNK169999R0000	20	14.00
	Universal wire markers holder	Grey <input type="checkbox"/>	UMH	1SNK900611R0000	10	0.20

Complete list of accessories is indicated in the terminal block datasheet including end stops.

Some accessories such as jumper bars may modify the terminal block's ratings: Complete information available in the accessories section of the catalog.



Ground screw clamp terminal blocks

Description	Color	Type	Part Number	Pkg qty	Weight (1 pce) g
Ground Profile aligned with ZS50	Green-yellow <input type="checkbox"/>	ZS50-PE	1SNK516151R0000	20	83.00

Technical data valid for copper conductors only.

ZS70 screw clamp terminal blocks

Feed-through - 22 mm 0.866 in spacing



ZS70

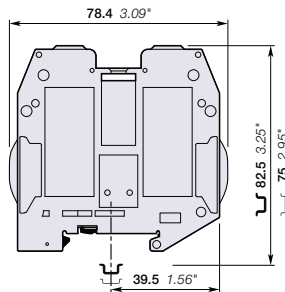

22 mm 0.866 in spacing

Description

Closed terminal block:

- No end section needed,
- Optimized rigidity,
- Perfectly adapted to solar applications: 1250 V DC (1000 V AC) IEC and 1000 V UL.

Ordering details

Description	Color	Type	Part Number	Pkg qty	Weight (1 pce) g
Feed-through Closed block	Grey	ZS70	1SNK522010R0000	10	158.10
	Blue	ZS70-BL	1SNK522020R0000	10	158.10
	Yellow	ZS70-YL	1SNK522060R0000	10	158.10

Main technical data

Connecting capacity		IEC	UL - CSA	Mounting instructions	
1 conductor per clamp	Rigid: Solid/Stranded	16 ... 95 mm ²	4 ... 00 AWG	Rail	TH 35-7.5, TH 35-15
	Flexible without ferrule	16 ... 70 mm ²		Wire stripping length	25 mm 0.984 in
	Flexible with non insulated ferrule	16 ... 50 mm ²			
	Flexible with insulated ferrule	16 ... 50 mm ²			
	Gauge	B11			
2 conductors per clamp	Rigid: Solid/Stranded	16 ... 35 mm ²	4 ... 2 AWG	Tool	Allen key Ø 6 mm Ø 0.236 in
	Flexible without ferrule	16 ... 35 mm ²			
	Flexible with twin ferrule	16 mm ²	6 AWG		
Rated current / Rated cross section		192 A / 70 mm ²	159 A / 00 AWG	Torque	6.5 Nm ± 0.5 57.5 lb.in ± 4.43
Rated short-time withstand current (1s)		8400 A			
Short Circuit Current Rating (with specific conditions)			100 kA		
Rated voltage		1000 V	1000 V		
Impulse withstand voltage		8000 V			
Protection		IP10	NEMA 1		

Increased safety Ex e 693 V 192 A IEC/EN 60079-7 - IM2 II 2 GD Ex eb I/II/III - 600 V 159 A UL 60079-7 - Class I, Zone 1, AEx e II, Ex e II U

The connecting capacity data for one Rigid: Solid/Stranded, or one Flexible conductor (when applicable) is a mandatory information required by IEC, UL and CSA standards (Copper conductors). All other data are provided as supplementary information only. For more details, please consult our CB, UL or CSA certificates and technical datasheet available on <http://www.TE.com>

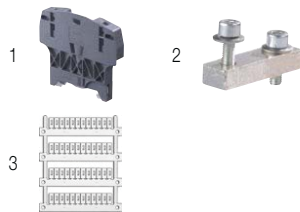

Accessories

Description	Color	Type	Part Number	Pkg qty	Weight (1 pce) g	
1 End stops	Dark grey	BAZH1	1SNK900102R0000	20	24.00	
2 Jumper bars		10 mm 0.394 in	JB22-2	1SNK922302R0000	5	27.00
		2 poles 192 A (IEC)	JB22-3	1SNK922303R0000	5	43.30
		3 poles 192 A (IEC)	JB22-5	1SNK922305R0000	5	76.10
		5 poles 192 A (IEC)	JB22-10	1SNK922310R0000	5	157.40
		10 poles 192 A (IEC)	MG-CPM 13 41791	1SNB041791R0612	1680	0.27
3 Terminal block markers	White	Blank marker	MC812	1SNK160000R0000	22	10.00
		Blank card	MC812PA	1SNK169999R0000	20	14.00
		Universal wire markers holder	UMH	1SNK900611R0000	10	0.20

Complete list of accessories is indicated in the terminal block datasheet including end stops.

Some accessories such as jumper bars may modify the terminal block's ratings: Complete information available in the accessories section of the catalog.

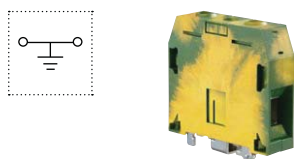

Ground screw clamp terminal blocks

Description	Color	Type	Part Number	Pkg qty	Weight (1 pce) g
Ground	Green-yellow	ZS70-PE	1SNK522150R0000	10	222.00

Technical data valid for copper conductors only.

ZS95 screw clamp terminal blocks

Feed-through - 26 mm 1.024 in spacing



ZS95

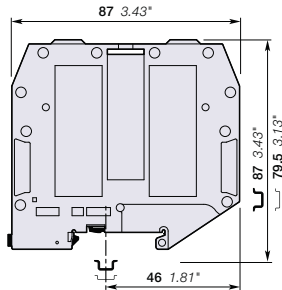

26 mm 1.024 in spacing

Description

Closed terminal block:

- No end section needed,
- Optimized rigidity,
- Perfectly adapted to solar applications: 1250 V DC (1000 V AC) IEC and 1000 V UL.

Ordering details

Description	Color	Type	Part Number	Pkg qty	Weight (1 pce)
Feed-through Closed block	Grey <input type="checkbox"/>	ZS95	1SNK526010R0000	10	215.10
	Blue <input type="checkbox"/>	ZS95-BL	1SNK526020R0000	10	215.10
	Yellow <input type="checkbox"/>	ZS95-YL	1SNK526060R0000	10	215.10

Main technical data

Connecting capacity		IEC	UL - CSA	Mounting instructions	
1 conductor per clamp	Rigid: Solid/Stranded	35 ... 120 mm ²	2 ... 0000 AWG	Rail	TH 35-7.5, TH 35-15
	Flexible without ferrule	35 ... 95 mm ²		Wire stripping length	26 mm 1.024 in
	Flexible with non insulated ferrule	35 ... 50 mm ²			
	Flexible with insulated ferrule	35 ... 50 mm ²		Tool	Allen key Ø 6 mm Ø 0.236 in
	Gauge	B12			
2 conductors per clamp	Rigid: Solid/Stranded	25 ... 35 mm ²	4 ... 2 AWG	Torque	9.25 Nm ± 0.25 81.7 lb.in ± 2.21
	Flexible without ferrule	25 ... 35 mm ²			
	Flexible with twin ferrule	16 mm ²	6 AWG		
Rated current / Rated cross section		232 A / 95 mm ²	230 A / 0000 AWG		
Rated short-time withstand current (1s)		11400 A			
Short Circuit Current Rating (with specific conditions)			100 kA		
Rated voltage		1000 V	1000 V		
Impulse withstand voltage		8000 V			
Protection		IP10	NEMA 1		
Increased safety Ex e		693 V 232 A IEC/EN 60079-7 - IM2 II 2 GD Ex eb I/II/III C - 600 V 230 A UL 60079-7 - Class I, Zone 1, AEx e II			

The connecting capacity data for one Rigid: Solid/Stranded, or one Flexible conductor (when applicable) is a mandatory information required by IEC, UL and CSA standards (Copper conductors). All other data are provided as supplementary information only. For more details, please consult our CB, UL or CSA certificates and technical datasheet available on <http://www.TE.com>



Accessories

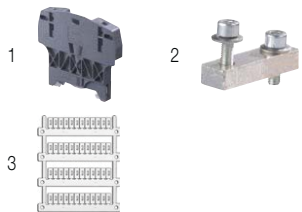

Description	Color	Type	Part Number	Pkg qty	Weight (1 pce)
1 End stops	Dark grey <input type="checkbox"/>	BAZH1	1SNK900102R0000	20	24.00
2 Jumper bars		JB26-2	1SNK926302R0000	5	41.20
		JB26-3	1SNK926303R0000	5	65.70
		JB26-5	1SNK926305R0000	5	115.70
		JB26-10	1SNK926310R0000	5	241.50
3 Terminal block markers	White <input type="checkbox"/>	MG-CPM 13 41791	1SNB041791R0612	1680	0.27
		MC812	1SNK160000R0000	22	10.00
		MC812PA	1SNK169999R0000	20	14.00
	Grey <input type="checkbox"/>	UMH	1SNK900611R0000	10	0.20

Complete list of accessories is indicated in the terminal block datasheet including end stops.

Some accessories such as jumper bars may modify the terminal block's ratings: Complete information available in the accessories section of the catalog.

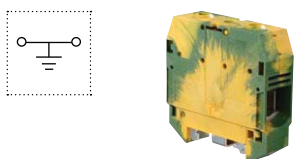

Ground screw clamp terminal blocks

Description	Color	Type	Part Number	Pkg qty	Weight (1 pce)
Ground Profile aligned with ZS95	Green-yellow <input type="checkbox"/>	ZS95-PE	1SNK526150R0000	10	278.00

Technical data valid for copper conductors only.

ZS150 screw clamp terminal blocks

Feed-through - 31 mm 1.220 in spacing

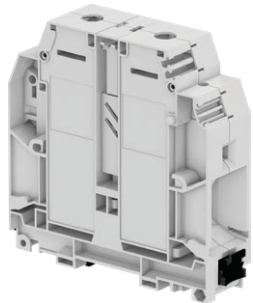

ZS150

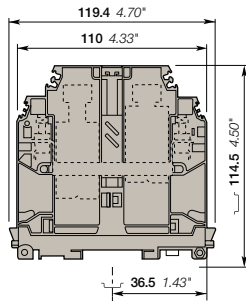

31 mm 1.220 in spacing

Description

- Perfectly adapted to solar applications : 1500V DC (1000V AC) IEC and 1000V UL,
- Closed terminal block: no end section needed, optimized rigidity,
- Ease your voltage monitoring or distribution with the 2 built-in derivations,
- Use of jumper bars requires the user to cut-out the partition.

Ordering details

Description	Color	Type	Part Number	Pkg qty	Weight (1 pce) g
Feed-through Closed block with 2 x 10 mm ² derivations.	Grey <input type="checkbox"/>	ZS150	1SNK531010R0000	5	318.00
	Blue <input type="checkbox"/>	ZS150-BL	1SNK531020R0000	5	318.00
	Yellow <input type="checkbox"/>	ZS150-YL	1SNK531060R0000	5	318.00

Main technical data

Connecting capacity	IEC	UL	CSA	Mounting instructions	
Main circuit with 1 conductor per clamp	Rigid: Solid/Stranded Flexible without ferrule Flexible with insulated ferrule Gauge	35 ... 185 mm ² 50 ... 150 mm ² B14	2 ... 350 Kcmil	2 ... 350 Kcmil	Rail TH 35-7.5, TH 35-15 Main circuit Wire stripping length 40 mm 1.575 in Tool Allen key Ø 8 mm Ø 0.315 in Torque 20 Nm 177 lb.in
Derivation with 1 conductor per clamp	Rigid: Solid/Stranded Flexible without ferrule Gauge	0.5 ... 16 mm ² 0.5 ... 10 mm ² B6	20 ... 8 AWG	20 ... 8 AWG	Derivation Wire stripping length 12 mm 0.47 in Tool Flat screwdriver Ø 4 mm Ø 0.157 in Torque 1.2 Nm ... 1.4 Nm 10.6 lb.in ... 12.3 lb.in
Rated current / Rated cross section	Main circuit Derivation	Copper Aluminium	309 A / 150 mm ²	310 A / 350 Kcmil	310 A / 350 Kcmil
Rated short-time withstand current (1s)			18000 A		
Rated voltage	V AC V DC		1000 V 1500	1000 V	1000 V
Impulse withstand voltage			12000 V		
Protection			IP10	NEMA 1	
Increased safety Ex e			1000 V 309 A IEC/EN 60079-7 - IM2 II 2 GD Ex eb I/II/III/C		

The connecting capacity data for one Rigid: Solid/Stranded, or one Flexible conductor (when applicable) is a mandatory information required by IEC, UL and CSA standards (Copper conductors). All other data are provided as supplementary information only. For more details, please consult our CB, UL or CSA certificates and technical datasheet available on <http://www.TE.com>

CE	IEC	RoHS	UL	CSA	EAC	ATEX	IECEx	BV

Accessories

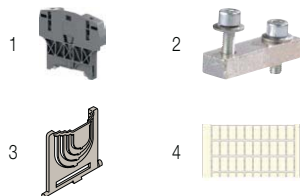

Description	Color	Type	Part Number	Pkg qty	Weight (1 pce) g
1 End stops	Dark grey <input type="checkbox"/>	BAZH1	1SNK900102R0000	20	24.00
2 Jumper bars		BJMI31.2	1SNA206053R0700	1	120.00
		BJMI31.3	1SNA206054R0000	1	190.00
3 Protecting covers		CPBP1	1SNA399788R1600	20	0.40
4 Terminal block markers		RC1010	1SNA238000R1600	10	1.30
		MG-CPM 13 41791	1SNB041791R0612	1680	0.27
		MC812	1SNK160000R0000	22	10.00
		MC812PA	1SNK169999R0000	20	14.00
		Universal wire markers holder	UMH	1SNK900611R0000	10

Complete list of accessories is indicated in the terminal block datasheet including end stops.

Some accessories such as jumper bars may modify the terminal block's ratings: Complete information available in the accessories section of the catalog.

Technical data valid for copper conductors only.

ZS240 screw clamp terminal blocks

Feed-through - 36 mm 1.417 in spacing

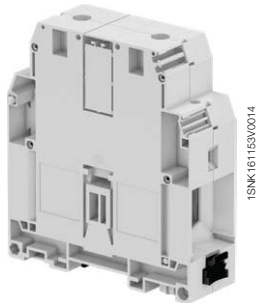

ZS240

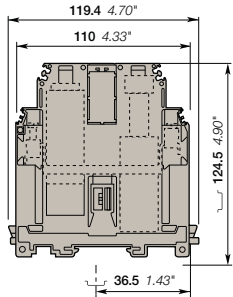

36 mm 1.417 in spacing

Description

- Perfectly adapted to solar applications : 1500V DC (1000V AC) IEC and 1000V UL,
- UL Certified for aluminum cables use - Closed terminal block: no end section needed, optimized rigidity,
- Ease your voltage monitoring or distribution with the 2 built-in derivations,
- Use of jumper bars requires the user to cut-out the partition.

Ordering details

Description	Color	Type	Part Number	Pkg qty	Weight (1 pce)
Feed-through Closed block with 2 x 10 mm ² derivations.	Grey <input type="checkbox"/>	ZS240	1SNK536010R0000	5	366.00
	Blue <input type="checkbox"/>	ZS240-BL	1SNK536020R0000	5	366.00
	Yellow <input type="checkbox"/>	ZS240-YL	1SNK536060R0000	5	366.00

Main technical data

Connecting capacity		IEC	UL	CSA	Mounting instructions	
Main circuit with 1 conductor per clamp	Rigid: Solid/Stranded	50 ... 300 mm ²	0 ... 500 Kcmil	0 ... 500 Kcmil	Main circuit	
	Flexible without ferrule	50 ... 240 mm ²			Wire stripping length	38 mm 1.496 in
	Flexible with insulated ferrule				Tool	Allen key Ø 8 mm Ø 0.315 in
Derivation with 1 conductor per clamp	Rigid: Solid/Stranded	0.5 ... 16 mm ²	20 ... 8 AWG	20 ... 8 AWG	Torque	25 Nm 221.3 lb.in
	Flexible without ferrule	0.5 ... 10 mm ²	20 ... 8 Kcmil	20 ... 8 Kcmil	Derivation	
	Gauge	B6			Wire stripping length	12 mm 0.47 in
Rated current / Rated cross section					Tool	Flat screwdriver Ø 4 mm Ø 0.157 in
Main circuit		Copper 415 A / 240 mm ²	380 A / 500 Kcmil	380 A / 500 Kcmil	Torque	1.2 Nm ... 1.4 Nm 10.6 lb.in ... 12.3 lb.in
Derivation		Aluminium 271 / 500 Kcmil	271 / 500 Kcmil	271 / 500 Kcmil		
Derivation		57 A / 10 mm ²	50 A / 8 AWG	50 A / 8 AWG		
Rated short-time withstand current (1s)		28800 A				
Rated voltage		V AC 1000 V	1000 V	1000 V		
V DC		1500				
Impulse withstand voltage		12000 V				
Protection		IP10	NEMA 1			
Increased safety Ex e		1000 V 415 A IEC/EN 60079-7 - IM2 II 2 GD Ex eb I/II/III				

The connecting capacity data for one Rigid: Solid/Stranded, or one Flexible conductor (when applicable) is a mandatory information required by IEC, UL and CSA standards (Copper conductors). All other data are provided as supplementary information only. For more details, please consult our CB, UL or CSA certificates and technical datasheet available on <http://www.TE.com>



Accessories

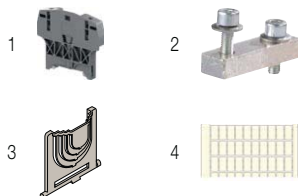

Description	Color	Type	Part Number	Pkg qty	Weight (1 pce)
1 End stops	Dark grey <input type="checkbox"/>	BAZH1	1SNK900102R0000	20	24.00
2 Jumper bars		BJMI36.2	1SNA206126R2500	1	170.00
		BJMI36.3	1SNA206223R0600	1	260.00
3 Protecting covers		CPBP2	1SNA399787R0500	20	1.30
4 Terminal block markers	White <input type="checkbox"/>	RC1010	1SNA238000R1600	10	1.30
		MG-CPM 13 41791	1SNB041791R0612	1680	0.27
		MC812	1SNK160000R0000	22	10.00
		MC812PA	1SNK169999R0000	20	14.00
		Grey <input type="checkbox"/>	UMH	1SNK900611R0000	10

Complete list of accessories is indicated in the terminal block datasheet including end stops.

Some accessories such as jumper bars may modify the terminal block's ratings: Complete information available in the accessories section of the catalog.

Technical data valid for copper conductors only.

ZS4-PE screw clamp terminal blocks

Ground - 5.2 mm 0.205 in spacing

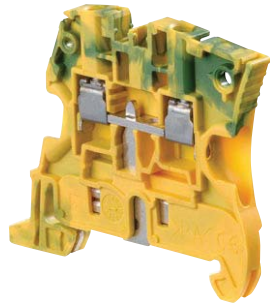

1SNK161018F0014

ZS4-PE

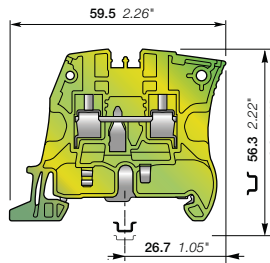

5.2 mm 0.205 in spacing

Description

Improve the safety of your installation in the event of a short-circuit thanks to our screwless rail contact:

- Rail contact non operator dependent,
- Performances above the requirements of IEC 60947-7-2 terminal block standard,
- Secured snap on or remove from the rail.

Ordering details

Description	Color	Type	Part Number	Pkg qty	Weight (1 pce) g
Ground Screwless rail connection	Green-yellow	ZS4-PE	1SNK505150R0000	20	12.10

Main technical data

Connecting capacity		IEC	UL - CSA	Mounting instructions	
1 conductor per clamp	Rigid: Solid/Stranded	0.2 ... 4 mm ²	24 ... 12 AWG	Rail	TH 35-7.5, TH 35-15
	Flexible without ferrule	0.22 ... 4 mm ²	24 ... 12 AWG	Wire stripping length	10.5 mm 0.412 in
	Flexible with non insulated ferrule	0.22 ... 4 mm ²	24 ... 12 AWG		
	Flexible with insulated ferrule	0.22 ... 2.5 mm ²	24 ... 14 AWG		
	Gauge	A3-B3		Tool	Flat screwdriver Ø 3.5 mm Ø 0.138 in
Rated cross section		4 mm ²	12 AWG	Torque	0.6 Nm ± 0.1 5.31 lb.in ± 0.885
Rated short-time withstand current (1s)		480 A	396 A		
Protection		IP20	NEMA 1		
Explosive atmosphere classification		IM2 II 2 GD Ex eb I/IIIC - Class I, Zone 1, AEx e II, Ex e II U			

The connecting capacity data for one Rigid: Solid/Stranded, or one Flexible conductor (when applicable) is a mandatory information required by IEC, UL and CSA standards (Copper conductors). All other data are provided as supplementary information only. For more details, please consult our CB, UL or CSA certificates and technical datasheet available on <http://www.TE.com>



Accessories

Description	Color	Type	Part Number	Pkg qty	Weight (1 pce) g
1 End stops 10 mm 0.394 in	Dark grey	BAM4	1SNK900001R0000	50	14.00
2 End sections 2.2 mm 0.087 in	Dark grey	ES4	1SNK505910R0000	20	2.20
3 Circuit separators 3 mm 0.118 in	Dark grey	CS-R1	1SNK900103R0000	20	5.20
4 Terminal block markers	White	MG-CPM 13 41790	1SNB041790R0512	1960	0.23
		MC512	1SNK140000R0000	22	9.00
		MC512PA	1SNK149999R0000	20	10.00
Universal wire markers holder	Grey	UMH	1SNK900611R0000	10	0.20

Complete list of accessories is indicated in the terminal block datasheet including end stops.

Some accessories such as jumper bars may modify the terminal block's ratings: Complete information available in the accessories section of the catalog.

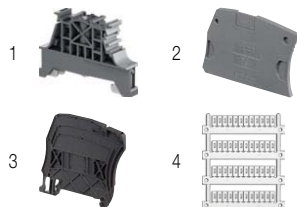

Technical data valid for copper conductors only.

ZS6-PE screw clamp terminal blocks

Ground - 6 mm 0.236 in spacing

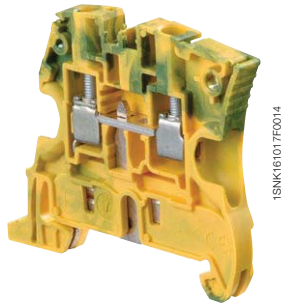

1SNK161017F0014

ZS6-PE

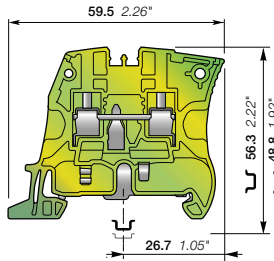

6 mm 0.236 in spacing

Description

Improve the safety of your installation in the event of a short-circuit thanks to our screwless rail contact:

- Rail contact non operator dependent,
- Performances above the requirements of IEC 60947-7-2 terminal block standard,
- Secured snap on or remove from the rail.

Ordering details

Description	Color	Type	Part Number	Pkg qty	Weight (1 pce)
Ground Screwless rail connection	Green-yellow	ZS6-PE	1SNK506150R0000	20	13.70

Main technical data

Connecting capacity		IEC	UL - CSA	Mounting instructions	
1 conductor per clamp	Rigid: Solid/Stranded	0.2 ... 6 mm ²	24 ... 10 AWG	Rail	TH 35-7.5, TH 35-15
	Flexible without ferrule	0.2 ... 6 mm ²		Wire stripping length	10.5 mm 0.412 in
	Flexible with non insulated ferrule	0.22 ... 4 mm ²	24 ... 12 AWG		
	Flexible with insulated ferrule	0.22 ... 4 mm ²	24 ... 12 AWG		
	Gauge	A4-B3		Tool	Flat screwdriver Ø 4 mm Ø 0.157 in
Rated cross section		6 mm ²	10 AWG	Torque	0.85 Nm ± 0.15 7.52 lb.in ± 1.33
Rated short-time withstand current (1s)		720 A	636 A		
Protection		IP20	NEMA 1		
Explosive atmosphere classification		IM2 II 2 GD Ex eb III/IIIC - Class I, Zone 1, AEx e II, Ex e II U			

The connecting capacity data for one Rigid: Solid/Stranded, or one Flexible conductor (when applicable) is a mandatory information required by IEC, UL and CSA standards (Copper conductors). All other data are provided as supplementary information only. For more details, please consult our CB, UL or CSA certificates and technical datasheet available on <http://www.TE.com>



Accessories

Description	Color	Type	Part Number	Pkg qty	Weight (1 pce)
1 End stops 10 mm 0.394 in	Dark grey	BAM4	1SNK900001R0000	50	14.00
2 End sections 2.2 mm 0.087 in	Dark grey	ES4	1SNK505910R0000	20	2.20
3 Circuit separators 3 mm 0.118 in	Dark grey	CS-R1	1SNK900103R0000	20	5.20
4 Terminal block markers	White	MG-CPM 13 41791	1SNB041791R0612	1680	0.27
		MC612	1SNK150000R0000	22	10.00
		MC612PA	1SNK159999R0000	20	11.00
Universal wire markers holder	Grey	UMH	1SNK900611R0000	10	0.20

Complete list of accessories is indicated in the terminal block datasheet including end stops. Some accessories such as jumper bars may modify the terminal block's ratings: Complete information available in the accessories section of the catalog.

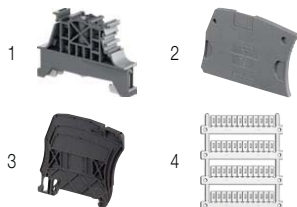

Technical data valid for copper conductors only.

ZS6-3S-PE screw clamp terminal blocks

Ground with 3 connections - 6 mm 0.236 in spacing



ZS6-3S-PE

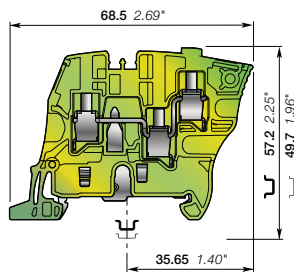

6 mm 0.236 in spacing

Description

Improve the safety of your installation in the event of a short-circuit thanks to our screwless rail contact:

- rail contact non operator dependent, secured snap on or off the rail,
- Same profile as ZS6-3S for aligned marking and identical end section.

Ordering details

Description	Color	Type	Part Number	Pkg qty	Weight (1 pce) g
Ground Screwless rail connection	Green-yellow	ZS6-3S-PE	1SNK506151R0000	25	16.20

Main technical data

Connecting capacity		IEC	UL - CSA	Mounting instructions	
1 conductor per clamp	Rigid: Solid/Stranded	0.2 ... 6 mm ²	24 ... 10 AWG	Rail	TH 35-7.5, TH 35-15
	Flexible without ferrule	0.22 ... 6 mm ²		Wire stripping length	10.5 mm 0.413 in
	Flexible with non insulated ferrule	0.22 ... 4 mm ²	24 ... 12 AWG		
	Flexible with insulated ferrule	0.22 ... 4 mm ²	24 ... 12 AWG		
	Gauge	A4-B3		Tool	Flat screwdriver Ø 4 mm Ø 0.157 in
Rated cross section		4 mm ²	10 AWG	Torque	0.75 Nm ± 0.05 6.64 lb.in ± 0.443
Maximum cross section		6 mm ²			
Rated short-time withstand current (1s)		480 A	636 A		
Maximum short-time withstand current (1s)		480 A		Protection	
Protection		IP20	NEMA 1	Explosive atmosphere classification	
		IM2 II 2 GD Ex eb I/IIIC - Class I, Zone 1, AEx e II			

The connecting capacity data for one Rigid: Solid/Stranded, or one Flexible conductor (when applicable) is a mandatory information required by IEC, UL and CSA standards (Copper conductors). All other data are provided as supplementary information only. For more details, please consult our CB, UL or CSA certificates and technical datasheet available on <http://www.TE.com>

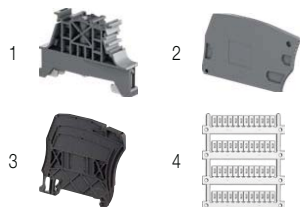

Accessories

Description	Color	Type	Part Number	Pkg qty	Weight (1 pce) g
1 End stops	Dark grey	BAM4	1SNK900001R0000	50	14.00
2 End sections	Dark grey	ES6-3S	1SNK505912R0000	20	2.50
3 Circuit separators	Dark grey	CS-R1	1SNK900103R0000	20	5.20
4 Terminal block markers	White	MG-CPM 13 41791	1SNB041791R0612	1680	0.27
		MC612	1SNK150000R0000	22	10.00
		MC612PA	1SNK159999R0000	20	11.00
Universal wire markers holder	Grey	UMH	1SNK900611R0000	10	0.20

Complete list of accessories is indicated in the terminal block datasheet including end stops. Some accessories such as jumper bars may modify the terminal block's ratings: Complete information available in the accessories section of the catalog.

Technical data valid for copper conductors only.

ZS6-4S-PE screw clamp terminal blocks

Ground with 4 connections - 6 mm 0.236 in spacing



ZS6-4S-PE

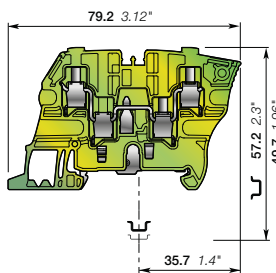

6 mm 0.236 in spacing

Description

Improve the safety of your installation in the event of a short-circuit thanks to our screwless rail contact:

- rail contact non operator dependent, secured snap on or off the rail,
- Same profile as ZS6-4S for aligned marking and identical end section.

Ordering details

Description	Color	Type	Part Number	Pkg qty	Weight (1 pce) g
Ground Screwless rail connection	Green-yellow	ZS6-4S-PE	1SNK506152R0000	25	19.40

Main technical data

Connecting capacity		IEC	UL - CSA	Mounting instructions	
1 conductor per clamp	Rigid: Solid/Stranded	0.2 ... 6 mm ²	24 ... 10 AWG	Rail	TH 35-7.5, TH 35-15
	Flexible without ferrule	0.22... 6 mm ²		Wire stripping length	10.5 mm 0.413 in
	Flexible with non insulated ferrule	0.22 ... 4 mm ²	24 ... 12 AWG		
	Flexible with insulated ferrule	0.22 ... 4 mm ²	24 ... 12 AWG		
	Gauge	A4-B3		Tool	Flat screwdriver Ø 4 mm Ø 0.157 in
Rated cross section		4 mm ²	10 AWG	Torque	0.75 Nm ± 0.05 6.64 lb.in ± 0.443
Maximum cross section		6 mm ²			
Rated short-time withstand current (1s)		480 A	636 A		
Maximum short-time withstand current (1s)		480 A			
Protection		IP20	NEMA 1		

Explosive atmosphere classification IM2 II 2 GD Ex eb I/II/III - Class I, Zone 1, AEx e II

The connecting capacity data for one Rigid: Solid/Stranded, or one Flexible conductor (when applicable) is a mandatory information required by IEC, UL and CSA standards (Copper conductors). All other data are provided as supplementary information only. For more details, please consult our CB, UL or CSA certificates and technical datasheet available on <http://www.TE.com>



Accessories

Description	Color	Type	Part Number	Pkg qty	Weight (1 pce) g
1 End stops 10 mm 0.394 in	Dark grey	BAM4	1SNK900001R0000	50	14.00
2 End sections 2.2 mm 0.087 in	Dark grey	ES6-4S	1SNK505911R0000	20	3.10
3 Circuit separators 3 mm 0.118 in	Dark grey	CS-R1	1SNK900103R0000	20	5.20
4 Terminal block markers	White	MG-CPM 13 41791	1SNB041791R0612	1680	0.27
		MC612	1SNK150000R0000	22	10.00
	Grey	MC612PA	1SNK159999R0000	20	11.00
		UMH	1SNK900611R0000	10	0.20

Complete list of accessories is indicated in the terminal block datasheet including end stops.

Some accessories such as jumper bars may modify the terminal block's ratings. Complete information available in the accessories section of the catalog.

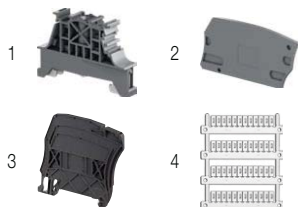

Technical data valid for copper conductors only.

ZS10-PE screw clamp terminal blocks

Ground - 8 mm 0.315 in spacing

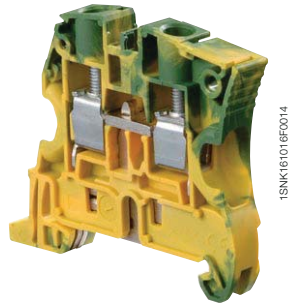

ZS10-PE

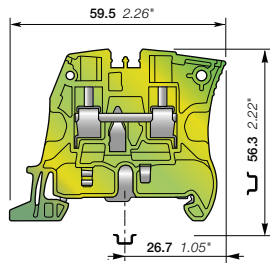

8 mm 0.315 in spacing

Description

Improve the safety of your installation in the event of a short-circuit thanks to our screwless rail contact:

- Rail contact non operator dependent,
- Performances above the requirements of IEC 60947-7-2 terminal block standard,
- Secured snap on or remove from the rail.

Ordering details

Description	Color	Type	Part Number	Pkg qty	Weight (1 pce) g
Ground Screwless rail connection	Green-yellow	ZS10-PE	1SNK508150R0000	20	22.50

Main technical data

Connecting capacity		IEC	UL - CSA	Mounting instructions	
1 conductor per clamp	Rigid: Solid/Stranded	0.5 ... 10 mm ²	24 ... 6 AWG	Rail	TH 35-7.5, TH 35-15
	Flexible without ferrule	0.5 ... 10 mm ²		Wire stripping length	12 mm 0.472 in
	Flexible with non insulated ferrule	0.5 ... 10 mm ²	24 ... 8 AWG		
	Flexible with insulated ferrule	0.5 ... 6 mm ²	24 ... 8 AWG		
	Gauge	A5-B5		Tool	Flat screwdriver Ø 4 mm Ø 0.157 in
Rated cross section		10 mm ²	6 AWG	Torque	1.3 Nm ± 0.3 11.5 lb.in ± 2.65
Rated short-time withstand current (1s)		1200 A	1596 A		
Protection		IP20	NEMA 1		
Explosive atmosphere classification		IM2 II 2 GD Ex eb I/IIIC - Class I, Zone 1, AEx e II, Ex e II U			

The connecting capacity data for one Rigid: Solid/Stranded, or one Flexible conductor (when applicable) is a mandatory information required by IEC, UL and CSA standards (Copper conductors). All other data are provided as supplementary information only. For more details, please consult our CB, UL or CSA certificates and technical datasheet available on <http://www.TE.com>



Accessories

Description	Color	Type	Part Number	Pkg qty	Weight (1 pce) g
1 End stops	Dark grey	BAM4	1SNK900001R0000	50	14.00
2 End sections	Dark grey	ES4	1SNK505910R0000	20	2.20
3 Circuit separators	Dark grey	CS-R1	1SNK900103R0000	20	5.20
4 Terminal block markers	White	MG-CPM 13 41791	1SNB041791R0612	1680	0.27
		MC812	1SNK160000R0000	22	10.00
		MC812PA	1SNK169999R0000	20	14.00
Universal wire markers holder	Grey	UMH	1SNK900611R0000	10	0.20

Complete list of accessories is indicated in the terminal block datasheet including end stops.

Some accessories such as jumper bars may modify the terminal block's ratings: Complete information available in the accessories section of the catalog.

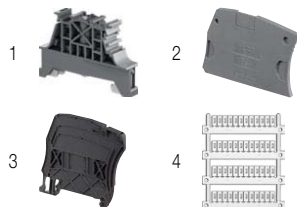

Technical data valid for copper conductors only.

ZS16-PE screw clamp terminal blocks

Ground - 10 mm 0.394 in spacing

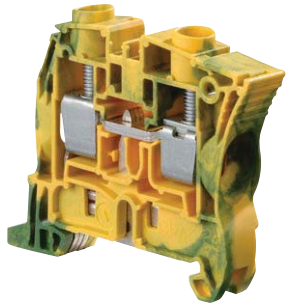

1SNK161019F0014

ZS16-PE

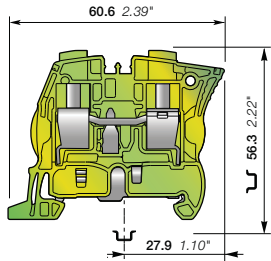

10 mm 0.394 in spacing

Description

- Improve the safety of your installation in the event of a short-circuit thanks to our screwless rail contact:
- Rail contact non operator dependent,
 - Performances above the requirements of IEC 60947-7-2 terminal block standard,
 - Secured snap on or remove from the rail,
 - PE.N function available by combining ZS16-PE with ZS16-BL and 2 poles jumper bar JB10-2.

Ordering details

Description	Color	Type	Part Number	Pkg qty	Weight (1 pce)
Ground Screwless rail connection	Green-yellow	ZS16-PE	1SNK510150R0000	20	32.00

Main technical data

Connecting capacity	IEC	UL - CSA	Mounting instructions	
1 conductor per clamp Rigid: Solid/Stranded Flexible without ferrule Flexible with non insulated ferrule Flexible with insulated ferrule Gauge	0.5 ... 16 mm ²	24 ... 4 AWG	Rail	TH 35-7.5, TH 35-15
	0.5 ... 16 mm ²	24 ... 4 AWG	Wire stripping length	13.5 mm 0.531 in
	0.5 ... 16 mm ²	24 ... 4 AWG	Tool	Flat screwdriver Ø 5.5 mm Ø 0.217 in
	0.5 ... 10 mm ²	24 ... 8 AWG		
	A6-B6		Torque	1.8 Nm ± 0.2 15.9 lb.in ± 1.77
Rated cross section	16 mm ²	4 AWG		
Rated short-time withstand current (1s)	1920 A	2544 A		
Protection	IP20	NEMA 1		
Explosive atmosphere classification	IM2 II 2 GD Ex eb III/IIIC - Class I, Zone 1, AEx e II, Ex e II U			

The connecting capacity data for one Rigid: Solid/Stranded, or one Flexible conductor (when applicable) is a mandatory information required by IEC, UL and CSA standards (Copper conductors). All other data are provided as supplementary information only. For more details, please consult our CB, UL or CSA certificates and technical datasheet available on <http://www.TE.com>



Accessories

Description	Color	Type	Part Number	Pkg qty	Weight (1 pce)	
1 End stops 10 mm 0.394 in	Dark grey	BAM4	1SNK900001R0000	50	14.00	
2 End sections 2.2 mm 0.087 in	Dark grey	ES4	1SNK505910R0000	20	2.20	
3 Circuit separators 3 mm 0.118 in	Dark grey	CS-R1	1SNK900103R0000	20	5.20	
4 Terminal block markers	Blank marker	White	MG-CPM 13 41791	1SNB041791R0612	1680	0.27
		MC812	1SNK160000R0000	22	10.00	
	Blank card	MC812PA	1SNK169999R0000	20	14.00	
		Universal wire markers holder	Grey	UMH	1SNK900611R0000	10

Complete list of accessories is indicated in the terminal block datasheet including end stops. Some accessories such as jumper bars may modify the terminal block's ratings: Complete information available in the accessories section of the catalog.

Technical data valid for copper conductors only.

ZS25-PE screw clamp terminal blocks

Ground - 12 mm 0.472 in spacing



ZS25-PE

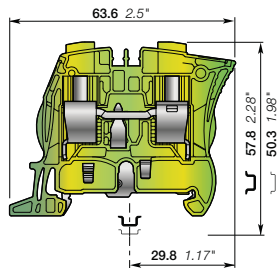

12 mm 0.472 in spacing

Description

Improve the safety of your installation in the event of a short-circuit thanks to our screwless rail contact:

- rail contact non operator dependent, secured snap on or off the rail,
- Same profile as ZS25 for aligned marking and identical end section.

Ordering details

Description	Color	Type	Part Number	Pkg qty	Weight (1 pce) g
Ground Screwless rail connection	Green-yellow	ZS25-PE	1SNK512150R000	20	38.00

Main technical data

Connecting capacity		IEC	UL - CSA	Mounting instructions	
1 conductor per clamp	Rigid: Solid/Stranded	0.5 ... 25 mm ²	24 ... 3 AWG	Rail	TH 35-7.5, TH 35-15
	Flexible without ferrule	0.5 ... 25 mm ²		Wire stripping length	13.5 mm 0.531 in
	Flexible with non insulated ferrule	0.5 ... 16 mm ²	24 ... 4 AWG		
	Flexible with insulated ferrule	0.5 ... 16 mm ²	24 ... 8 AWG		
Gauge		A6-B6		Tool	Flat screwdriver Ø 5.5 mm Ø 0.217 in
Rated cross section		16 mm ²	3 AWG	Torque	1.8 Nm ± 0.2 15.9 lb.in ± 1.77
Maximum cross section		25 mm ²			
Rated short-time withstand current (1s)		1920 A	3204 A		
Maximum short-time withstand current (1s)		3000 A			
Protection		IP20	NEMA 1		

Explosive atmosphere classification

IM2 II 2 GD Ex eb I/IIIC - Class I, Zone 1, AEx e II, Ex e II U

The connecting capacity data for one Rigid: Solid/Stranded, or one Flexible conductor (when applicable) is a mandatory information required by IEC, UL and CSA standards (Copper conductors). All other data are provided as supplementary information only. For more details, please consult our CB, UL or CSA certificates and technical datasheet available on <http://www.TE.com>

CE	CB	RoHS	UL	CSA	EAC Ex	ATEX	IECEx	BFR-Ex e II	Haz Loc	BV	DIN

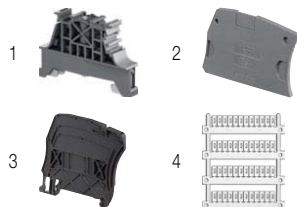

Accessories

Description	Color	Type	Part Number	Pkg qty	Weight (1 pce) g
1 End stops	Dark grey	BAM4	1SNK900001R000	50	14.00
2 End sections	Dark grey	ES4	1SNK505910R000	20	2.20
3 Circuit separators	Dark grey	CS-R1	1SNK900103R000	20	5.20
4 Terminal block markers	White	MG-CPM 13 41791	1SNB041791R0612	1680	0.27
		MC812	1SNK160000R000	22	10.00
		MC812PA	1SNK169999R000	20	14.00
Universal wire markers holder	Grey	UMH	1SNK900611R000	10	0.20

Complete list of accessories is indicated in the terminal block datasheet including end stops.

Some accessories such as jumper bars may modify the terminal block's ratings: Complete information available in the accessories section of the catalog.

Technical data valid for copper conductors only.

ZS35-PE screw clamp terminal blocks

Ground - 16 mm 0.630 in spacing



ZS35-PE

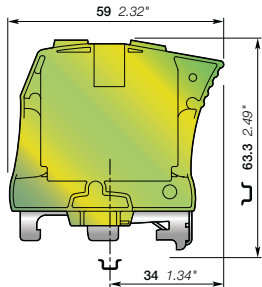

16 mm 0.630 in spacing

Description

Reliable electrical and mechanical contact with the rail that exceeds the requirements of IEC 60947-7-2 terminal block standard.

Ordering details

Description	Color	Type	Part Number	Pkg qty	Weight (1 pce)
Ground Screw rail connection	Green-yellow	ZS35-PE	1SNK516150R0000	20	81.80 g

Main technical data

Connecting capacity	IEC	UL - CSA	Mounting instructions
1 conductor per clamp			
Rigid: Solid/Stranded	6 ... 35 mm ²	10 ... 2 AWG	Rail
Flexible without ferrule	6 ... 35 mm ²		Wire stripping length
Flexible with non insulated ferrule	4 ... 35 mm ²	10 ... 2 AWG	Tool
Flexible with insulated ferrule	4 ... 35 mm ²	10 ... 2 AWG	Screw clamp
Gauge	A9		Rail connection screw
Rated cross section	35 mm ²	2 AWG	Torque
Rated short-time withstand current (1s)	4200 A	4032 A	Screw clamp
Protection	IP10	NEMA 1	Rail connection screw

Explosive atmosphere classification IM2 II 2 GD Ex eb III/IIIC - Class I, Zone 1, AEx e II

The connecting capacity data for one Rigid: Solid/Stranded, or one Flexible conductor (when applicable) is a mandatory information required by IEC, UL and CSA standards (Copper conductors). All other data are provided as supplementary information only. For more details, please consult our CB, UL or CSA certificates and technical datasheet available on <http://www.TE.com>



Accessories

Description	Color	Type	Part Number	Pkg qty	Weight (1 pce)
1 End stops 10 mm 0.394 in	Dark grey	BAZH1	1SNK900102R0000	20	24.00
2 Circuit separators 3 mm 0.118 in	Dark grey	CS-R1	1SNK900103R0000	20	5.20
3 Terminal block markers	White	MG-CPM 13 41791	1SNB041791R0612	1680	0.27
		MC812	1SNK160000R0000	22	10.00
		MC812PA	1SNK169999R0000	20	14.00
Universal wire markers holder	Grey	UMH	1SNK900611R0000	10	0.20

Complete list of accessories is indicated in the terminal block datasheet including end stops. Some accessories such as jumper bars may modify the terminal block's ratings: Complete information available in the accessories section of the catalog.

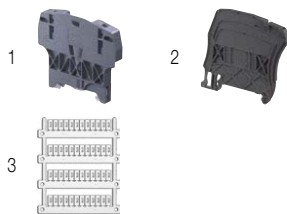

Technical data valid for copper conductors only.

ZS35-PEN screw clamp terminal blocks

Ground + neutral - 32 mm 1.260 in spacing

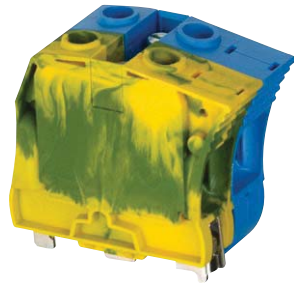

ZS35-PEN

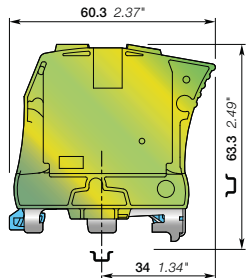

32 mm 1.260 in spacing

Description

Simplify your PE.N connection with ZS35-PE block connected to ZS35-BL through a pre-mounted jumper.

Ordering details

Description	Color	Type	Part Number	Pkg qty	Weight (1 pce) g
Ground + neutral	Green-yellow	ZS35-PEN	1SNK516170R0000	10	236.00

Main technical data

Connecting capacity		IEC	UL - CSA	Mounting instructions	
1 conductor per clamp	Rigid: Solid/Stranded	6 ... 35 mm ²		Rail	TH 35-7.5, TH 35-15
	Flexible without ferrule	6 ... 35 mm ²		Wire stripping length	17 mm 0.669 in
	Flexible with non insulated ferrule	6 ... 35 mm ²	10 ... 2 AWG	Tool	Flat screwdriver
	Flexible with insulated ferrule	6 ... 35 mm ²		Screw clamp	Ø 6.5 mm Ø 0.256 in
	Gauge	A9		Rail connection screw	Ø 5.5 Ø 0.217
Rated cross section		35 mm ²		Torque	2.65 Nm ± 0.15 23.5 lb.in ± 1.33
Rated short-time withstand current (1s)		4200 A		Screw clamp	1.6 Nm ± 0.15 Nm 14.2 lb.in ± 1.33 lb.in
Rail connection screw				Rail connection screw	
Protection		IP10	NEMA 1		

The connecting capacity data for one Rigid: Solid/Stranded, or one Flexible conductor (when applicable) is a mandatory information required by IEC, UL and CSA standards (Copper conductors). All other data are provided as supplementary information only. For more details, please consult our CB, UL or CSA certificates and technical datasheet available on <http://www.TE.com>

CE	RoHS	EAC							
CE	RoHS	EAC							

Accessories

Description	Color	Type	Part Number	Pkg qty	Weight (1 pce) g
1 End stops	Dark grey	BAZH1	1SNK900102R0000	20	24.00
2 Terminal block markers	White	MG-CPM 13 41791	1SNB041791R0612	1680	0.27
		MC812	1SNK160000R0000	22	10.00
	Grey	MC812PA	1SNK169999R0000	20	14.00
		UMH	1SNK900611R0000	10	0.20

Complete list of accessories is indicated in the terminal block datasheet including end stops. Some accessories such as jumper bars may modify the terminal block's ratings: Complete information available in the accessories section of the catalog.



Technical data valid for copper conductors only.

ZS50-PE screw clamp terminal blocks

Ground - 16 mm 0.630 in spacing



1SNK161095V0014

ZS50-PE

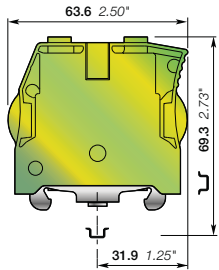

16 mm 0.630 in spacing

Description

– Reliable electrical and mechanical contact with the rail that exceeds the requirements of the IEC 60947-7-2 terminal block standard.

Ordering details

Description	Color	Type	Part Number	Pkg qty	Weight (1 pce)
Ground Screw rail connection	Green-yellow	ZS50-PE	1SNK516151R0000	20	83.00 g

Main technical data

Connecting capacity		IEC	UL - CSA	Mounting instructions	
1 conductor per clamp	Rigid: Solid/Stranded	1 ... 50 mm ²	18 ... 0 AWG	Rail	TH 35-7.5, TH 35-15
	Flexible without ferrule	1 ... 50 mm ²		Wire stripping length	17 mm 0.669 in
	Flexible with non insulated ferrule	1 ... 50 mm ²	18 ... 0 AWG	Tool	
	Flexible with insulated ferrule	1 ... 50 mm ²	18 ... 0 AWG	Screw clamp	
	Gauge	Dia. 11		Rail connection screw	Ø 6.5 Ø 0.256
Rated cross section		50 mm ²	0 AWG	Torque	
Rated short-time withstand current (1s)		6000 A	6420 A	Screw clamp	
Protection		IP10	NEMA 1	Rail connection screw	3 Nm ± 0.25 Nm 26.553 lb.in ± 2.21 lb.in
Explosive atmosphere classification		IM2 II 2 GD Ex eb III/IIIC - Class I, Zone 1, AEx e II			

The connecting capacity data for one Rigid: Solid/Stranded, or one Flexible conductor (when applicable) is a mandatory information required by IEC, UL and CSA standards (Copper conductors). All other data are provided as supplementary information only. For more details, please consult our CB, UL or CSA certificates and technical datasheet available on <http://www.TE.com>



Accessories

Description	Color	Type	Part Number	Pkg qty	Weight (1 pce)
1 End stops	Dark grey	BAZH1	1SNK900102R0000	20	24.00
2 Terminal block markers	White	Blank marker	MG-CPM 13 41791	1680	0.27
		Blank card	MC812	1SNK160000R0000	22
	Grey	MC812PA	1SNK169999R0000	20	14.00
		Universal wire markers holder	UMH	1SNK900611R0000	10

Complete list of accessories is indicated in the terminal block datasheet including end stops. Some accessories such as jumper bars may modify the terminal block's ratings. Complete information available in the accessories section of the catalog.

Technical data valid for copper conductors only.

ZS70-PE screw clamp terminal blocks

Ground - 22 mm 0.866 in spacing

		70 mm²
		00 AWG

Description

Reliable electrical and mechanical contact with the rail that exceeds the requirements of IEC 60947-7-2 terminal block standard.

Ordering details

Description	Color	Type	Part Number	Pkg qty	Weight (1 pce)
Ground Screw rail connection	Green-yellow	ZS70-PE	1SNK522150R0000	10	222.00 g

Main technical data

Connecting capacity	IEC	UL - CSA	Mounting instructions
1 conductor per clamp			
Rigid: Solid/Stranded	16 ... 95 mm ²	4 ... 00 AWG	Wire stripping length
Flexible without ferrule	16 ... 70 mm ²		25 mm 0.984 in
Flexible with non insulated ferrule	16 ... 50 mm ²		Tool
Flexible with insulated ferrule	16 ... 50 mm ²		Screw clamp
Gauge	B11		Rail connection screw
			Allen key Ø 6 mm Ø 0.236 in
			Rail connection screw Ø 4 Ø 0.158
Rated cross section	70 mm ²	00 AWG	Torque
Rated short-time withstand current (1s)	8400 A	8088 A	Screw clamp
			6.5 Nm ± 0.5 57.5 lb.in ± 4.43
			Rail connection screw
			1.9 Nm ± 0.1 Nm 16.82 lb.in ± 0.885 lb.in
Protection	IP10	NEMA 1	
Explosive atmosphere classification	IM2 II 2 GD Ex eb I/IIIC - Class I, Zone 1, AEx e II, Ex e II U		

The connecting capacity data for one Rigid: Solid/Stranded, or one Flexible conductor (when applicable) is a mandatory information required by IEC, UL and CSA standards (Copper conductors). All other data are provided as supplementary information only. For more details, please consult our CB, UL or CSA certificates and technical datasheet available on <http://www.TE.com>

CE	CB	RoHS	UL	CSA	EAC Ex	ATEX	IECEx	BR-Ex e II	Haz Loc	BV	DNV	Rina



ZS70-PE

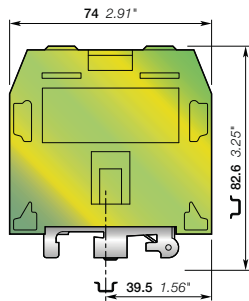

22 mm 0.866 in spacing



Accessories

Description	Color	Type	Part Number	Pkg qty	Weight (1 pce)
1 End stops	Dark grey	BAZH1	1SNK900102R0000	20	24.00 g
2 Terminal block markers	White	MG-CPM 13 41791	1SNB041791R0612	1680	0.27 g
		MC812	1SNK160000R0000	22	10.00 g
		MC812PA	1SNK169999R0000	20	14.00 g
	Universal wire markers holder	Grey	UMH	1SNK900611R0000	10

Complete list of accessories is indicated in the terminal block datasheet including end stops.

Some accessories such as jumper bars may modify the terminal block's ratings: Complete information available in the accessories section of the catalog.

Technical data valid for copper conductors only.

ZS95-PE screw clamp terminal blocks

Ground - 26 mm 1.024 in spacing

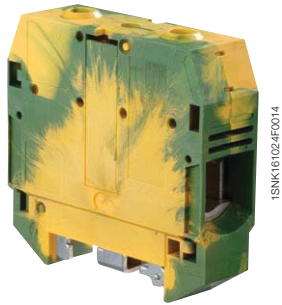

ZS95-PE

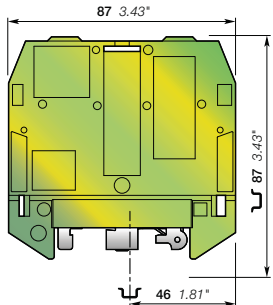

26 mm 1.024 in spacing



Description

Reliable electrical and mechanical contact with the rail that exceeds the requirements of IEC 60947-7-2 terminal block standard.

Ordering details

Description	Color	Type	Part Number	Pkg qty	Weight (1 pce)
Ground Screw rail connection	Green-yellow	ZS95-PE	1SNK526150R0000	10	278.00

Main technical data

Connecting capacity		IEC	UL - CSA	Mounting instructions	
1 conductor per clamp	Rigid: Solid/Stranded	35 ... 120 mm ²	2 ... 0000 AWG	Rail	TH 35-15
	Flexible without ferrule	35 ... 95 mm ²		Wire stripping length	26 mm 1.024 in
	Flexible with non insulated ferrule	35 ... 50 mm ²		Tool	Allen key
	Flexible with insulated ferrule	35 ... 50 mm ²		Screw clamp	Ø 6 mm
	Gauge	B12		Rail connection screw	Ø 0.236 in
Rated cross section		95 mm ²	0000 AWG	Torque	9.25 Nm ± 0.25
Rated short-time withstand current (1s)		11400 A	12840 A	Screw clamp	81.7 lb.in ± 2.2
Protection		IP10	NEMA 1	Rail connection screw	1.9 Nm ± 0.1 Nm
Explosive atmosphere classification		IM2 II 2 GD Ex eb III/II C - Class I, Zone 1, AEx e II, Ex e II U			

The connecting capacity data for one Rigid: Solid/Stranded, or one Flexible conductor (when applicable) is a mandatory information required by IEC, UL and CSA standards (Copper conductors). All other data are provided as supplementary information only. For more details, please consult our CB, UL or CSA certificates and technical datasheet available on <http://www.TE.com>



Accessories

Description	Color	Type	Part Number	Pkg qty	Weight (1 pce)
1 End stops	Dark grey	BAZH1	1SNK900102R0000	20	24.00
2 Terminal block markers	White	MG-CPM 13 41791	1SNB041791R0612	1680	0.27
		MC812	1SNK160000R0000	22	10.00
		MC812PA	1SNK169999R0000	20	14.00
	Universal wire markers holder	Grey	UMH	1SNK900611R0000	10

Complete list of accessories is indicated in the terminal block datasheet including end stops. Some accessories such as jumper bars may modify the terminal block's ratings. Complete information available in the accessories section of the catalog.

Technical data valid for copper conductors only.

ZS4-S screw clamp terminal blocks

Disconnect with blade - 5.2 mm 0.205 in spacing



ZS4-S

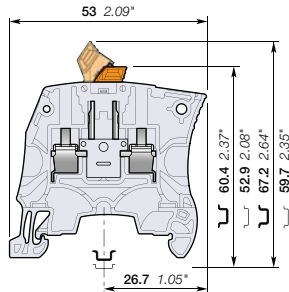

5.2 mm 0.205 in spacing

Description

- Ease your disconnect operations with the disconnect blade operated by hand or with a screwdriver,
- Same profile as ZS4 feed-through terminal block for aligned marking and identical end section use.

Ordering details

Description	Color	Type	Part Number	Pkg qty	Weight (1 pce) g
Disconnect Profile aligned with ZS4	Grey <input type="checkbox"/>	ZS4-S	1SNK505310R0000	50	8.60
	Blue <input type="checkbox"/>	ZS4-S-BL	1SNK505320R0000	50	8.60
	Orange <input type="checkbox"/>	ZS4-S-OR	1SNK505330R0000	50	8.60

Main technical data

Connecting capacity		IEC	UL - CSA	Mounting instructions	
1 conductor per clamp	Rigid: Solid/Stranded	0.2 ... 4 mm²	24 ... 10 AWG	Rail	TH 35-7.5, TH 35-15
	Flexible without ferrule	0.2 ... 4 mm²		Wire stripping length	10.5 mm 0.412 in
	Flexible with non insulated ferrule	0.22 ... 4 mm²	24 ... 10 AWG		
	Flexible with insulated ferrule	0.22 ... 2.5 mm²	24 ... 14 AWG		
	Gauge	A3-B3			
2 conductors per clamp	Rigid: Solid/Stranded	0.2 ... 1.5 mm²	24 ... 16 AWG	Tool	Flat screwdriver Ø 3.5 mm Ø 0.138 in
	Flexible without ferrule	0.2 ... 1.5 mm²			
	Flexible with twin ferrule	0.22 ... 1.5 mm²	24 ... 16 AWG		
Rated current / Rated cross section		25 A / 4 mm²	25 A / 10 AWG	Torque	0.6 Nm ± 0.1 5.31 lb.in ± 0.885
Rated short-time withstand current (1s)		480 A			
Rated voltage		400 V	150 V		
Impulse withstand voltage		6000 V			
Protection		IP20	NEMA 1		

Recommendation for best usage: in horizontal assemblies, disconnect terminal blocks should be mounted with fixed foot on top (power side) so that the disconnect knife does not partially close through gravity. Furthermore, as specified per IEC 60947-7-1, disconnect terminal blocks are intended to be used for temporary disconnection at zero potential and at no load.

The connecting capacity data for one Rigid: Solid/Stranded, or one Flexible conductor (when applicable) is a mandatory information required by IEC, UL and CSA standards (Copper conductors). All other data are provided as supplementary information only. For more details, please consult our CB, UL or CSA certificates and technical datasheet available on <http://www.TE.com>

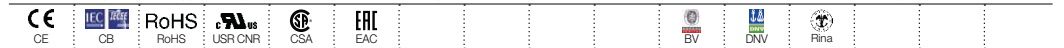

Accessories

Description	Color	Type	Part Number	Pkg qty	Weight (1 pce) g
1 End stops 10 mm 0.394 in	Dark grey <input type="checkbox"/>	BAM4	1SNK900001R0000	50	14.00
2 End sections 2.2 mm 0.087 in	Dark grey <input type="checkbox"/>	ES4	1SNK505910R0000	20	2.20
3 Lateral jumper bars 2 poles 30 A (IEC)	Grey <input type="checkbox"/>	PC5-2	1SNA113542R1000	10	1.80
		PC5-10	1SNA113544R1200	10	6.00
4 Circuit separators 3 mm 0.118 in	Dark grey <input type="checkbox"/>	CS-R1	1SNK900103R0000	20	5.20
5 Shield connectors		SHBS	1SNK900600R0000	20	3.50
6 Protecting covers 5.2 mm 0.205 in spacing	Transparent <input checked="" type="checkbox"/>	PL5	1SNK900618R0000	10	1.50
7 Terminal block markers	White <input type="checkbox"/>	MG-CPM 13 41790	1SNB041790R0512	1960	0.23
		MC512	1SNK140000R0000	22	9.00
		MC512PA	1SNK149999R0000	20	10.00
Universal wire markers holder	Grey <input type="checkbox"/>	UMH	1SNK900611R0000	10	0.20

Complete list of accessories is indicated in the terminal block datasheet including end stops.

Some accessories such as jumper bars may modify the terminal block's ratings: Complete information available in the accessories section of the catalog.



Technical data valid for copper conductors only.

ZS4-S-T screw clamp terminal blocks

Disconnect with blade - with test socket - 5.2 mm 0.205 in spacing

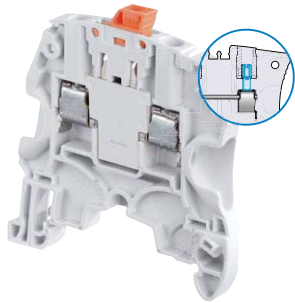
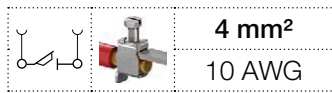

1SNK161004R0014

ZS4-S-T

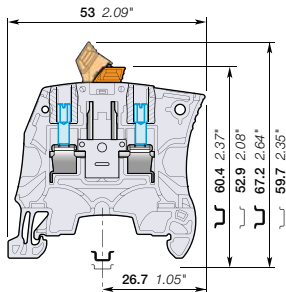

5.2 mm 0.205 in spacing

Description

- Ease your test operations with the 2 built-in test sockets,
- Screwdriver or hand operated disconnect blade,
- Same profile as ZS4 feed-through terminal block for aligned marking and identical end section use.

Ordering details

Description	Color	Type	Part Number	Pkg qty	Weight (1 pce) g
Disconnect Profile aligned with ZS4, with 2 test sockets DIA 2 mm 0.079 in	Grey	ZS4-S-T2	1SNK505311R0000	50	8.90
	Blue	ZS4-S-T2-BL	1SNK505321R0000	50	8.90
	Orange	ZS4-S-T2-OR	1SNK505331R0000	50	8.90
	Grey	ZS4-S-T2.3	1SNK505312R0000	50	8.80
Profile aligned with ZS4, with 2 test sockets DIA 2.3 mm 0.091 in					

Main technical data

Connecting capacity	IEC	UL - CSA	Rail	Mounting instructions
1 conductor per clamp Rigid: Solid/Stranded Flexible without ferrule Flexible with non insulated ferrule Flexible with insulated ferrule Gauge	0.2 ... 4 mm ²	24 ... 10 AWG	Wire stripping length	TH 35-7.5, TH 35-15 10.5 mm 0.412 in
	0.22 ... 4 mm ²			
	0.22 ... 4 mm ²	24 ... 10 AWG		
	0.22 ... 2.5 mm ²	24 ... 14 AWG		
2 conductors per clamp Rigid: Solid/Stranded Flexible without ferrule Flexible with twin ferrule	0.2 ... 1.5 mm ²	24 ... 16 AWG	Tool	Flat screwdriver Ø 3.5 mm Ø 0.138 in
	0.2 ... 1.5 mm ²			
	0.22 ... 1.5 mm ²	24 ... 16 AWG		
Rated current / Rated cross section		25 A / 4 mm ²	25 A / 10 AWG	
Rated short-time withstand current (1s)		480 A	Torque	0.6 Nm ± 0.1 5.31 lb.in ± 0.885
Rated voltage		400 V		
Impulse withstand voltage		6000 V		
Protection		IP20	NEMA 1	

Recommendation for best usage: in horizontal assemblies, disconnect terminal blocks should be mounted with fixed foot on top (power side) so that the disconnect knife does not partially close through gravity. Furthermore, as specified per IEC 60947-7-1, disconnect terminal blocks are intended to be used for temporary disconnection at zero potential and at no load.

The connecting capacity data for one Rigid: Solid/Stranded, or one Flexible conductor (when applicable) is a mandatory information required by IEC, UL and CSA standards (Copper conductors). All other data are provided as supplementary information only. For more details, please consult our CB, UL or CSA certificates and technical datasheet available on <http://www.TE.com>

CE	RoHS	USF CNR	CSA	EAC
----	------	---------	-----	-----

Accessories

Description	Color	Type	Part Number	Pkg qty	Weight (1 pce) g	
1 End stops	Dark grey	BAM4	1SNK900001R0000	50	14.00	
2 End sections	Dark grey	ES4	1SNK505910R0000	20	2.20	
3 Lateral jumper bars	Grey	2 poles	30 A (IEC)	1SNA113542R1000	10	1.80
		10 poles	30 A (IEC)	1SNA113544R1200	10	6.00
4 Circuit separators	Dark grey	CS-R1	1SNK900103R0000	20	5.20	
5 Shield connectors		SHBS	1SNK900600R0000	20	3.50	
6 Protecting covers	Transparent	3 mm	0.118 in	1SNK900618R0000	10	1.50
		5.2 mm 0.205 in spacing		PL5		
7 Terminal block markers	White	Blank marker	MG-CPM 13 41790	1SNB041790R0512	1960	0.23
		Blank card	MC512	1SNK140000R0000	22	9.00
		Universal wire markers holder	MC512PA	1SNK149999R0000	20	10.00
	Grey	UMH	1SNK900611R0000	10	0.20	

Complete list of accessories is indicated in the terminal block datasheet including end stops. Some accessories such as jumper bars may modify the terminal block's ratings: Complete information available in the accessories section of the catalog.



Technical data valid for copper conductors only.

ZS4-S-R1 screw clamp terminal blocks

Disconnect with blade - 6 mm 0.236 in spacing



1SNK161003E0014

ZS4-S-R1

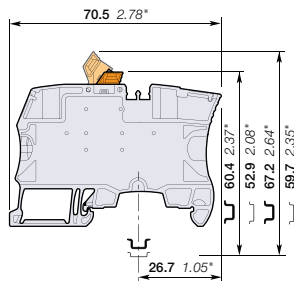

6 mm 0.236 in spacing

Description

- Simplify the alternated distribution thanks to the two jumper channels aligned with ZS4 feed-through terminal blocks,
- Ease your disconnect operations with the disconnect blade operated by hand or with a screwdriver.

Ordering details

Description	Color	Type	Part Number	Pkg qty	Weight (1 pce) g
Disconnect Profile aligned with ZS4-SF	Grey	ZS4-S-R1	1SNK506310R0000	50	13.20
	Blue	ZS4-S-R1-BL	1SNK506320R0000	50	13.20
	Orange	ZS4-S-R1-OR	1SNK506330R0000	50	13.20

Main technical data

Connecting capacity		IEC	UL - CSA	Mounting instructions	
1 conductor per clamp	Rigid: Solid/Stranded	0.2 ... 4 mm²	24 ... 10 AWG	Rail	TH 35-7.5, TH 35-15
	Flexible without ferrule	0.22 ... 4 mm²		Wire stripping length	10.5 mm 0.412 in
	Flexible with non insulated ferrule	0.22 ... 4 mm²	24 ... 12 AWG		
	Flexible with insulated ferrule	0.22 ... 4 mm²	24 ... 12 AWG		
	Gauge	A3-B3			
2 conductors per clamp	Rigid: Solid/Stranded	0.2 ... 1.5 mm²	24 ... 16 AWG	Tool	Flat screwdriver Ø 3.5 mm Ø 0.138 in
	Flexible without ferrule	0.2 ... 1.5 mm²			
	Flexible with twin ferrule	0.22 ... 1.5 mm²	24 ... 16 AWG		
Rated current / Rated cross section		26 A / 4 mm²	26 A / 10 AWG		
Rated short-time withstand current (1s)		480 A		Torque	0.6 Nm ± 0.1 5.31 lb.in ± 0.885
Rated voltage		400 V	150 V		
Impulse withstand voltage		6000 V			
Protection		IP20	NEMA 1		

Recommendation for best usage: in horizontal assemblies, disconnect terminal blocks should be mounted with fixed foot on top (power side) so that the disconnect knife does not partially close through gravity. Furthermore, as specified per IEC 60947-7-1, disconnect terminal blocks are intended to be used for temporary disconnection at zero potential and at no load.

The connecting capacity data for one Rigid: Solid/Stranded, or one Flexible conductor (when applicable) is a mandatory information required by IEC, UL and CSA standards (Copper conductors). All other data are provided as supplementary information only. For more details, please consult our CB, UL or CSA certificates and technical datasheet available on <http://www.TE.com>

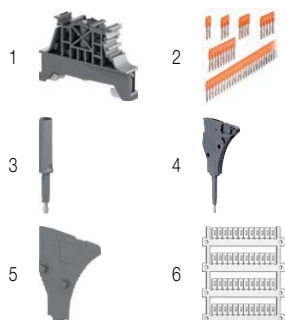
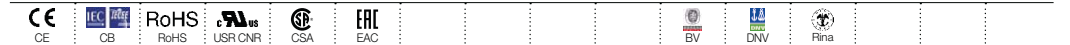

Accessories

Description	Color	Type	Part Number	Pkg qty	Weight (1 pce) g	
1 End stops	Dark grey	BAM4	1SNK900001R0000	50	14.00	
2 Jumper bars	Orange	2 poles	JB6-2	1SNK906302R0000	50	1.30
		3 poles	JB6-3	1SNK906303R0000	50	2.10
		4 poles	JB6-4	1SNK906304R0000	50	2.90
		5 poles	JB6-5	1SNK906305R0000	50	3.60
		10 poles	JB6-10	1SNK906310R0000	20	7.40
		3 Test adapters	Dark grey	For test plugs DIA 2 mm 0.079 in	TP2	1SNK900203R0000
For test plugs DIA 4 mm 0.157 in	TP4			1SNK900205R0000	20	2.40
4 Test connectors	Dark grey	TC5-R1	1SNK900201R0000	10	5.20	
5 Spacers	Dark grey	ES-TC6	1SNK900105R0000	10	0.80	
6 Terminal block markers	White	Blank marker	MG-CPM 13 41791	1SNB041791R0612	1680	0.27
		Blank card	MC612	1SNK150000R0000	22	10.00
			MC612PA	1SNK159999R0000	20	11.00
		Universal wire markers holder	UMH	1SNK900611R0000	10	0.20

Complete list of accessories is indicated in the terminal block datasheet including end stops. Some accessories such as jumper bars may modify the terminal block's ratings: Complete information available in the accessories section of the catalog.

Technical data valid for copper conductors only.

ZS4-S-T-R1 screw clamp terminal blocks

Disconnect with blade - with test socket - 6 mm 0.236 in spacing



ZS4-S-T-R1

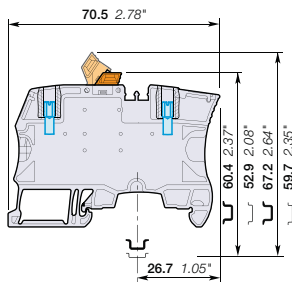

6 mm 0.236 in spacing

Description

- Ease your test operations with the 2 built-in test sockets,
- Screwdriver or hand operated disconnect blade,
- Simplify the alternated distribution thanks to the two jumper channels aligned with ZS4 feed-through terminal blocks.

Ordering details

Description	Color	Type	Part Number	Pkg qty	Weight (1 pce) g
Disconnect Profile aligned with ZS4-SF, with 2 test sockets DIA 2 mm 0.079 in	Grey	ZS4-S-T2-R1	1SNK506311R0000	50	14.20
	Blue	ZS4-S-T2-R1-BL	1SNK506321R0000	50	14.20
Profile aligned with ZS4-SF, with 2 test sockets DIA 2.3 mm 0.091 in	Orange	ZS4-S-T2-R1-OR	1SNK506331R0000	50	14.20
	Grey	ZS4-S-T2.3-R1	1SNK506312R0000	50	14.20

Main technical data

Connecting capacity	IEC	UL - CSA	Mounting instructions
1 conductor per clamp	Rigid: Solid/Stranded	0.2 ... 4 mm ²	24 ... 10 AWG
	Flexible without ferrule	0.22 ... 4 mm ²	
	Flexible with non insulated ferrule	0.22 ... 4 mm ²	24 ... 12 AWG
	Flexible with insulated ferrule	0.22 ... 4 mm ²	24 ... 12 AWG
2 conductors per clamp	Rigid: Solid/Stranded	0.2 ... 1.5 mm ²	24 ... 16 AWG
	Flexible without ferrule	0.22 ... 1.5 mm ²	24 ... 16 AWG
Rated current / Rated cross section		26 A / 4 mm ²	26 A / 10 AWG
	Rated short-time withstand current (1s)	480 A	
Rated voltage	400 V	150 V	
Impulse withstand voltage	6000 V		
Protection	IP20	NEMA 1	

Recommendation for best usage: in horizontal assemblies, disconnect terminal blocks should be mounted with fixed foot on top (power side) so that the disconnect knife does not partially close through gravity. Furthermore, as specified per IEC 60947-7-1, disconnect terminal blocks are intended to be used for temporary disconnection at zero potential and at no load.

The connecting capacity data for one Rigid: Solid/Stranded, or one Flexible conductor (when applicable) is a mandatory information required by IEC, UL and CSA standards (Copper conductors). All other data are provided as supplementary information only. For more details, please consult our CB, UL or CSA certificates and technical datasheet available on <http://www.TE.com>

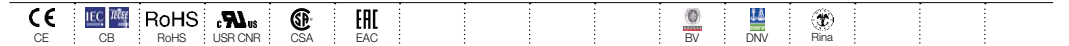

Accessories

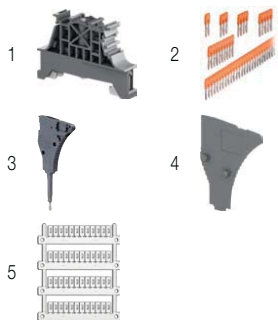

Description	Color	Type	Part Number	Pkg qty	Weight (1 pce) g	
1 End stops	Dark grey	BAM4	1SNK900001R0000	50	14.00	
2 Jumper bars	Orange	2 poles	JB6-2	1SNK906302R0000	50	1.30
		3 poles	JB6-3	1SNK906303R0000	50	2.10
		4 poles	JB6-4	1SNK906304R0000	50	2.90
		5 poles	JB6-5	1SNK906305R0000	50	3.60
		10 poles	JB6-10	1SNK906310R0000	20	7.40
3 Test connectors	Dark grey	TC5-R1	1SNK900201R0000	10	5.20	
4 Spacers	Dark grey	ES-TC6	1SNK900105R0000	10	0.80	
5 Terminal block markers	White	Blank marker	MG-CPM 13 41791	1SNB041791R0612	1680	0.27
		Blank card	MC612	1SNK150000R0000	22	10.00
			MC612PA	1SNK159999R0000	20	11.00
	Universal wire markers holder	Grey	UMH	1SNK900611R0000	10	0.20

Complete list of accessories is indicated in the terminal block datasheet including end stops. Some accessories such as jumper bars may modify the terminal block's ratings: Complete information available in the accessories section of the catalog.

Technical data valid for copper conductors only.

ZS6-S screw clamp terminal blocks

Disconnect with blade - 6 mm 0.236 in spacing

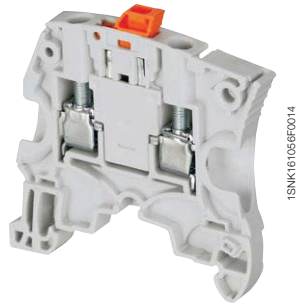

1SNK161056F0014

ZS6-S

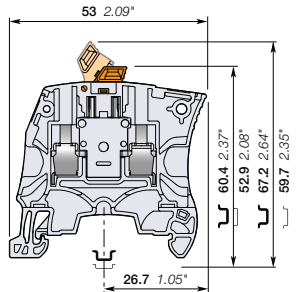

6 mm 0.236 in spacing

Description

- Ease your disconnect operations with the disconnect blade operated by hand or with a screwdriver,
- Same profile as ZS6 feed-through terminal block for aligned marking and identical end section use.

Ordering details

Description	Color	Type	Part Number	Pkg qty	Weight (1 pce) g
Disconnect Profile aligned with ZS6	Grey <input type="checkbox"/>	ZS6-S	1SNK506315R0000	50	8.60
	Blue <input type="checkbox"/>	ZS6-S-BL	1SNK506322R0000	50	8.60

Main technical data

Connecting capacity		IEC	UL - CSA	Rail	TH 35-7.5, TH 35-15
1 conductor per clamp	Rigid: Solid/Stranded	0.2 ... 6 mm ²	24 ... 10 AWG	Wire stripping length	10.5 mm 0.412 in
	Flexible without ferrule	0.22 ... 6 mm ²	24 ... 12 AWG		
	Flexible with non insulated ferrule	0.22 ... 6 mm ²	24 ... 12 AWG		
	Flexible with insulated ferrule	0.22 ... 4 mm ²	24 ... 12 AWG		
Gauge		A4-B3			
2 conductors per clamp	Rigid: Solid/Stranded	0.2 ... 2.5 mm ²	24 ... 14 AWG	Tool	Flat screwdriver Ø 4 mm Ø 0.157 in
	Flexible without ferrule	0.22 ... 2.5 mm ²	24 ... 14 AWG		
	Flexible with twin ferrule	0.22 ... 2.5 mm ²	24 ... 14 AWG		
Rated current / Rated cross section		25 A / 4 mm ²	25 A / 10 AWG		
Maximum current / Maximum cross section		30 A / 6 mm ²			
Rated short-time withstand current (1s)		480 A		Torque	0.85 Nm ± 0.15 7.52 lb.in ± 1.33
Rated voltage		500 V	300 V		
Impulse withstand voltage		6000 V			
Protection		IP20	NEMA 1		

Mounting instructions

Recommendation for best usage: in horizontal assemblies, disconnect terminal blocks should be mounted with fixed foot on top (power side) so that the disconnect knife does not partially close through gravity. Furthermore, as specified per IEC 60947-7-1, disconnect terminal blocks are intended to be used for temporary disconnection at zero potential and at no load.

The connecting capacity data for one Rigid: Solid/Stranded, or one Flexible conductor (when applicable) is a mandatory information required by IEC, UL and CSA standards (Copper conductors). All other data are provided as supplementary information only. For more details, please consult our CB, UL or CSA certificates and technical datasheet available on <http://www.TE.com>



Accessories

Description	Color	Type	Part Number	Pkg qty	Weight (1 pce) g	
1 End stops 10 mm 0.394 in	Dark grey <input type="checkbox"/>	BAM4	1SNK900001R0000	50	14.00	
2 End sections 2.2 mm 0.087 in	Dark grey <input type="checkbox"/>	ES4	1SNK505910R0000	20	2.20	
3 Circuit separators 3 mm 0.118 in	Dark grey <input type="checkbox"/>	CS-R1	1SNK900103R0000	20	5.20	
4 Shield connectors		SHBS	1SNK900600R0000	20	3.50	
5 Protecting covers 6 mm 0.236 in spacing	Transparent <input checked="" type="checkbox"/>	PL6	1SNK900619R0000	10	1.80	
6 Terminal block markers	Blank marker	MG-CPM 13 41791	1SNB041791R0612	1680	0.27	
	Blank card	MC612	1SNK150000R0000	22	10.00	
		MC612PA	1SNK159999R0000	20	11.00	
	Universal wire markers holder	Grey <input type="checkbox"/>	UMH	1SNK900611R0000	10	0.20

Complete list of accessories is indicated in the terminal block datasheet including end stops. Some accessories such as jumper bars may modify the terminal block's ratings: Complete information available in the accessories section of the catalog.



Technical data valid for copper conductors only.

ZS6-S-4S-T screw clamp terminal blocks

Disconnect with blade - with test socket screws - 6 mm 0.236 in spacing

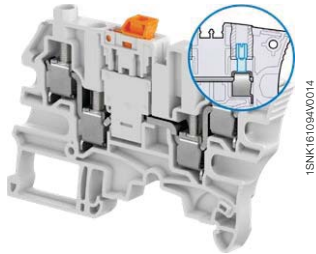

ZS6-S-4S-T

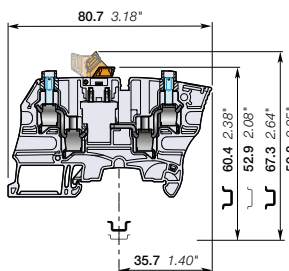

6 mm 0.236 in spacing

Description

- Recommended for energy markets and highly demanding applications requiring that only one conductor be connected per clamp,
- Ease your disconnect and test operations with the two built-in test socket screws,
- Simplify the alternated distribution thanks to the jumper channel.

Ordering details

Description	Color	Type	Part Number	Pkg qty	Weight (1 pce)
Disconnect with 2 test sockets DIA 2 mm 0,079 in	Grey <input type="checkbox"/>	ZS6-S-4S-T2	1SNK506316R0000	50	18.40

Main technical data

Connecting capacity		IEC	UL - CSA	Mounting instructions	
1 conductor per clamp	Rigid: Solid/Stranded	0.2 ... 6 mm ²	24 ... 10 AWG	Rail	TH 35-7.5, TH 35-15
	Flexible without ferrule	0.22 ... 6 mm ²		Wire stripping length	10.5 mm 0.413 in
	Flexible with non insulated ferrule	0.22 ... 4 mm ²	24 ... 12 AWG	Tool	Flat screwdriver Ø 4 mm Ø 0.157 in
	Flexible with insulated ferrule	0.22 ... 4 mm ²	24 ... 12 AWG		
Gauge		A4-B3		Torque	0.85 Nm ± 0.15 7.52 lb.in ± 1.33
2 conductors per clamp	Rigid: Solid/Stranded	0.2 ... 2.5 mm ²	24 ... 14 AWG		
	Flexible without ferrule	0.2 ... 2.5 mm ²			
	Flexible with twin ferrule	0.22 ... 2.5 mm ²	24 ... 14 AWG		
Rated current / Rated cross section		27 A / 4 mm ²	28 A / 10 AWG		
Rated short-time withstand current (1s)		480 A			
Rated voltage		500 V	300 V		
Impulse withstand voltage		6000 V			
Protection		IP20	NEMA 1		

Recommendation for best usage: in horizontal assemblies, disconnect terminal blocks should be mounted with fixed foot on top (power side) so that the disconnect knife does not partially close through gravity. Furthermore, as specified per IEC 60947-7-1, disconnect terminal blocks are intended to be used for temporary disconnection at zero potential and at no load.

The connecting capacity data for one Rigid: Solid/Stranded, or one Flexible conductor (when applicable) is a mandatory information required by IEC, UL and CSA standards (Copper conductors). All other data are provided as supplementary information only. For more details, please consult our CB, UL or CSA certificates and technical datasheet available on <http://www.TE.com>



Accessories

Description	Color	Type	Part Number	Pkg qty	Weight (1 pce)	
1 End stops	Dark grey <input type="checkbox"/>	BAM4	1SNK900001R0000	50	14.00	
2 End sections	Dark grey <input type="checkbox"/>	ES6-4S	1SNK505911R0000	20	3.10	
3 Jumper bars	Orange <input type="checkbox"/>	2 poles	1SNK906302R0000	50	1.30	
		3 poles	1SNK906303R0000	50	2.10	
		4 poles	1SNK906304R0000	50	2.90	
		5 poles	1SNK906305R0000	50	3.60	
		10 poles	1SNK906310R0000	20	7.40	
4 Circuit separators	Dark grey <input type="checkbox"/>	CS-R1	1SNK900103R0000	20	5.20	
5 Test adapters	Dark grey <input type="checkbox"/>	For test plugs DIA 2 mm 0.079 in	1SNK900203R0000	20	1.70	
		For test plugs DIA 4 mm 0.157 in	1SNK900205R0000	20	2.40	
6 Test connectors	Dark grey <input type="checkbox"/>	TC5-R1	1SNK900201R0000	10	5.20	
7 Spacers	Dark grey <input type="checkbox"/>	ES-TC6	1SNK900105R0000	10	0.80	
8 Terminal block markers	White <input type="checkbox"/>	Blank marker	1SNB041791R0612	1680	0.27	
		Blank card	MC612	1SNK150000R0000	22	10.00
			MC612PA	1SNK159999R0000	20	11.00
		Universal wire markers holder	Grey <input type="checkbox"/>	UMH	1SNK900611R0000	10

Complete list of accessories is indicated in the terminal block datasheet including end stops. Some accessories such as jumper bars may modify the terminal block's ratings: Complete information available in the accessories section of the catalog.

Technical data valid for copper conductors only.

ZS10-S screw clamp terminal blocks

Disconnect with blade - 8 mm 0.315 in spacing



ZS10-S

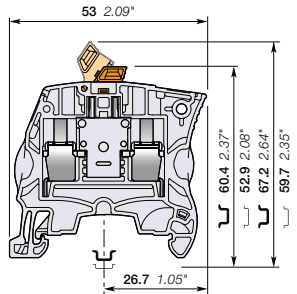

8 mm 0.315 in spacing

Description

- Ease your disconnect operations with the disconnect blade operated by hand or with a screwdriver,
- Same profile as ZS10 feed-through terminal block for aligned marking and identical end section use.

Ordering details

Description	Color	Type	Part Number	Pkg qty	Weight (1 pce) g
Disconnect Profile aligned with ZS10	Grey <input type="checkbox"/>	ZS10-S	1SNK508315R0000	50	8.60
	Blue <input type="checkbox"/>	ZS10-S-BL	1SNK508320R0000	50	8.60

Main technical data

Connecting capacity	IEC	UL - CSA	Mounting instructions
1 conductor per clamp Rigid: Solid/Stranded Flexible without ferrule Flexible with non insulated ferrule Flexible with insulated ferrule Gauge	0.2 ... 10 mm ²	24 ... 6 AWG	Rail TH 35-7.5, TH 35-15 Wire stripping length 12 mm 0.472 in
	0.22 ... 10 mm ²	24 ... 12 AWG	Tool Flat screwdriver Ø 4 mm Ø 0.157 in
	0.22 ... 10 mm ²	24 ... 12 AWG	
	0.22 ... 6 mm ²	24 ... 12 AWG	
2 conductors per clamp Rigid: Solid/Stranded Flexible without ferrule Flexible with twin ferrule	0.5 ... 4 mm ²	20 ... 12 AWG	Torque 1.3 Nm ± 0.3 11.5 lb.in ± 2.65
	0.5 ... 4 mm ²	20 ... 12 AWG	
Rated current / Rated cross section	25 A / 4 mm ²	25 A / 6 AWG	
Maximum current / Maximum cross section	42 A / 10 mm ²		
Rated short-time withstand current (1s)	480 A		
Rated voltage	630 V	300 V	
Impulse withstand voltage	6000 V		
Protection	IP20	NEMA 1	

Recommendation for best usage: in horizontal assemblies, disconnect terminal blocks should be mounted with fixed foot on top (power side) so that the disconnect knife does not partially close through gravity. Furthermore, as specified per IEC 60947-7-1, disconnect terminal blocks are intended to be used for temporary disconnection at zero potential and at no load.

The connecting capacity data for one Rigid: Solid/Stranded, or one Flexible conductor (when applicable) is a mandatory information required by IEC, UL and CSA standards (Copper conductors). All other data are provided as supplementary information only. For more details, please consult our CB, UL or CSA certificates and technical datasheet available on <http://www.TE.com>

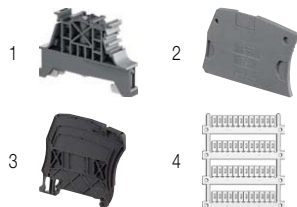

Accessories

Description	Color	Type	Part Number	Pkg qty	Weight (1 pce) g
1 End stops 10 mm 0.394 in	Dark grey <input checked="" type="checkbox"/>	BAM4	1SNK900001R0000	50	14.00
2 End sections 2.2 mm 0.087 in	Dark grey <input checked="" type="checkbox"/>	ES4	1SNK505910R0000	20	2.20
3 Circuit separators 3 mm 0.118 in	Dark grey <input checked="" type="checkbox"/>	CS-R1	1SNK900103R0000	20	5.20
4 Terminal block markers	White <input type="checkbox"/>	MG-CPM 13 41791	1SNB041791R0612	1680	0.27
		MC812	1SNK160000R0000	22	10.00
		MC812PA	1SNK169999R0000	20	14.00
Universal wire markers holder	Grey <input type="checkbox"/>	UMH	1SNK900611R0000	10	0.20

Complete list of accessories is indicated in the terminal block datasheet including end stops.

Some accessories such as jumper bars may modify the terminal block's ratings: Complete information available in the accessories section of the catalog.

Technical data valid for copper conductors only.

ZS4-SP screw clamp terminal blocks

Disconnect with plug - 5.2 mm 0.205 in spacing



ZS4-SP

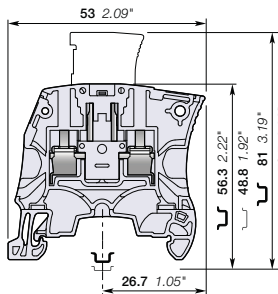

5.2 mm 0.205 in spacing

Description

- Save time with our screwless component holder plug,
- Same profile as ZS4 feed-through terminal block for aligned marking and identical end section use.

Ordering details

Description	Color	Type	Part Number	Pkg qty	Weight (1 pce)
Disconnect Profile aligned with ZS4, plug delivered separately	Grey <input type="checkbox"/>	ZS4-SP	1SNK505313R0000	50	8.20

Main technical data

Connecting capacity		IEC	UL - CSA	Mounting instructions	
1 conductor per clamp	Rigid: Solid/Stranded	0.2 ... 4 mm ²	24 ... 10 AWG	Rail	TH 35-7.5, TH 35-15
	Flexible without ferrule	0.22 ... 4 mm ²		Wire stripping length	10.5 mm 0.412 in
	Flexible with non insulated ferrule	0.22 ... 4 mm ²	24 ... 10 AWG	Tool	Flat screwdriver Ø 3.5 mm Ø 0.138 in
	Flexible with insulated ferrule	0.22 ... 2.5 mm ²	24 ... 14 AWG		
Gauge		A3-B3		Torque	0.6 Nm ± 0.1 5.31 lb.in ± 0.885
2 conductors per clamp	Rigid: Solid/Stranded	0.2 ... 1.5 mm ²	24 ... 16 AWG		
	Flexible without ferrule	0.2 ... 1.5 mm ²	24 ... 16 AWG		
Flexible with twin ferrule		0.22 ... 1.5 mm ²	24 ... 16 AWG		
Rated current / Rated cross section		18 A / 2.5 mm ²	18 A / 10 AWG		
Rated short-time withstand current (1s)		300 A			
Rated voltage		400 V	150 V		
Impulse withstand voltage		6000 V			
Protection		IP20	NEMA 1		

The connecting capacity data for one Rigid: Solid/Stranded, or one Flexible conductor (when applicable) is a mandatory information required by IEC, UL and CSA standards (Copper conductors). All other data are provided as supplementary information only. For more details, please consult our CB, UL or CSA certificates and technical datasheet available on <http://www.TE.com>

CE	RoHS	UL	CSA	EAC
CE	RoHS	UL	CSA	EAC

Accessories

Description	Color	Type	Part Number	Pkg qty	Weight (1 pce)
1 End stops 10 mm 0.394 in	Dark grey <input checked="" type="checkbox"/>	BAM4	1SNK900001R0000	50	14.00
2 End sections 2.2 mm 0.087 in	Dark grey <input checked="" type="checkbox"/>	ES4	1SNK505910R0000	20	2.20
3 Lateral jumper bars 2 poles 30 A (IEC)	Grey <input type="checkbox"/>	PC5-2	1SNA113542R1000	10	1.80
		PC5-10	1SNA113544R1200	10	6.00
4 Shield connectors		SHBS	1SNK900600R0000	20	3.50
5 Component plugs Components in series with circuit	Dark grey <input checked="" type="checkbox"/>	PG5	1SNK900401R0000	20	3.50
6 Disconnect plugs Equipped with linking bar	Orange <input checked="" type="checkbox"/>	PG5-R1	1SNK900402R0000	20	3.50
7 Terminal block markers	White <input type="checkbox"/>	MG-CPM 13 41790	1SNB041790R0512	1960	0.23
		MC512	1SNK140000R0000	22	9.00
		MC512PA	1SNK149999R0000	20	10.00
Universal wire markers holder	Grey <input type="checkbox"/>	UMH	1SNK900611R0000	10	0.20

Complete list of accessories is indicated in the terminal block datasheet including end stops. Some accessories such as jumper bars may modify the terminal block's ratings: Complete information available in the accessories section of the catalog.

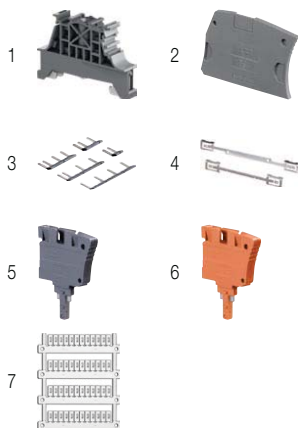

Technical data valid for copper conductors only.

ZS4-SP-T2 screw clamp terminal blocks

Disconnect with plug - with test socket - 5.2 mm 0.205 in spacing



ZS4-SP-T2

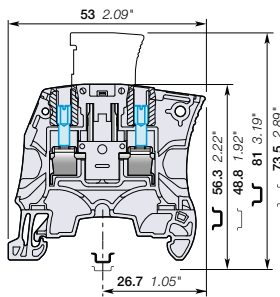

5.2 mm 0.205 in spacing

Description

- Ease your test operations with the 2 built-in test sockets DIA 2 mm 0.079 in,
- Save time with our screwless component holder plug,
- Same profile as ZS4 feed-through terminal block for aligned marking and identical end section use.

Ordering details

Description	Color	Type	Part Number	Pkg qty	Weight (1 pce) g
Disconnect Profile aligned with ZS4, with 2 test sockets DIA 2 mm 0.079 in, plug delivered separately	Grey <input type="checkbox"/>	ZS4-SP-T2	1SNK505314R0000	50	8.40

Main technical data

Connecting capacity	IEC	UL - CSA	Mounting instructions
1 conductor per clamp	Rigid: Solid/Stranded Flexible without ferrule Flexible with non insulated ferrule Flexible with insulated ferrule Gauge	0.2 ... 4 mm ² 0.22 ... 4 mm ² 0.22 ... 4 mm ² 0.22 ... 2.5 mm ² A3-B3	24 ... 10 AWG 24 ... 10 AWG 24 ... 10 AWG 24 ... 14 AWG
2 conductors per clamp	Rigid: Solid/Stranded Flexible without ferrule Flexible with twin ferrule	0.2 ... 1.5 mm ² 0.2 ... 1.5 mm ² 0.22 ... 1.5 mm ²	24 ... 16 AWG 24 ... 16 AWG 24 ... 16 AWG
Rated current / Rated cross section		18 A / 2.5 mm ²	18 A / 10 AWG
Rated short-time withstand current (1s)		300 A	
Rated voltage		400 V	150 V
Impulse withstand voltage		6000 V	
Protection		IP20	NEMA 1

The connecting capacity data for one Rigid: Solid/Stranded, or one Flexible conductor (when applicable) is a mandatory information required by IEC, UL and CSA standards (Copper conductors). All other data are provided as supplementary information only. For more details, please consult our CB, UL or CSA certificates and technical datasheet available on <http://www.TE.com>

CE	RoHS	UL	CSA	EAC
CE	RoHS	UL	CSA	EAC

Accessories

Description	Color	Type	Part Number	Pkg qty	Weight (1 pce) g
1 End stops 10 mm 0.394 in	Dark grey <input checked="" type="checkbox"/>	BAM4	1SNK900001R0000	50	14.00
2 End sections 2.2 mm 0.087 in	Dark grey <input checked="" type="checkbox"/>	ES4	1SNK505910R0000	20	2.20
3 Lateral jumper bars 2 poles 30 A (IEC)	Grey <input type="checkbox"/>	PC5-2	1SNA113542R1000	10	1.80
		PC5-10	1SNA113544R1200	10	6.00
4 Shield connectors		SHBS	1SNK900600R0000	20	3.50
5 Component plugs Components in series with circuit	Dark grey <input checked="" type="checkbox"/>	PG5	1SNK900401R0000	20	3.50
6 Disconnect plugs Equipped with linking bar	Orange <input checked="" type="checkbox"/>	PG5-R1	1SNK900402R0000	20	3.50
7 Terminal block markers	White <input type="checkbox"/>	MG-CPM 13 41790	1SNB041790R0512	1960	0.23
		MC512	1SNK140000R0000	22	9.00
		MC512PA	1SNK149999R0000	20	10.00
Universal wire markers holder	Grey <input type="checkbox"/>	UMH	1SNK900611R0000	10	0.20

Complete list of accessories is indicated in the terminal block datasheet including end stops. Some accessories such as jumper bars may modify the terminal block's ratings: Complete information available in the accessories section of the catalog.

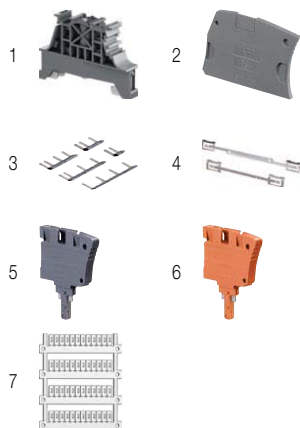

Technical data valid for copper conductors only.

ZS4-SP-R1 screw clamp terminal blocks

Disconnect with plug - 6 mm 0.236 in spacing



ZS4-SP-R1

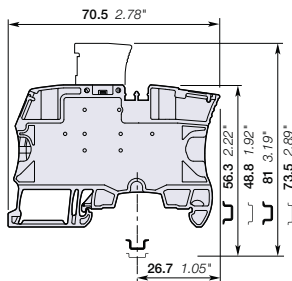

6 mm 0.236 in spacing

Description

- Simplify the alternated distribution between feed-through and disconnect circuits thanks to the two aligned jumper channels,
- Save time with our screwless component holder plug.

Ordering details

Description	Color	Type	Part Number	Pkg qty	Weight (1 pce) g
Disconnect Profile aligned with ZS4-SF, plug delivered separately	Grey <input type="checkbox"/>	ZS4-SP-R1	1SNK506313R0000	50	14.20

Main technical data

Connecting capacity		IEC	UL - CSA	Mounting instructions	
1 conductor per clamp	Rigid: Solid/Stranded	0.2 ... 4 mm ²	24 ... 10 AWG	Rail	TH 35-7.5, TH 35-15
	Flexible without ferrule	0.22 ... 4 mm ²	24 ... 12 AWG	Wire stripping length	10.5 mm 0.412 in
	Flexible with non insulated ferrule	0.22 ... 4 mm ²	24 ... 12 AWG	Tool	Flat screwdriver Ø 3.5 mm Ø 0.138 in
	Flexible with insulated ferrule	0.22 ... 4 mm ²	24 ... 12 AWG		
	Gauge	A3-B3			
2 conductors per clamp	Rigid: Solid/Stranded	0.2 ... 1.5 mm ²	24 ... 16 AWG	Torque	0.6 Nm ± 0.1 5.31 lb.in ± 0.885
	Flexible without ferrule	0.2 ... 1.5 mm ²	24 ... 16 AWG		
	Flexible with twin ferrule	0.22 ... 1.5 mm ²	24 ... 16 AWG		
Rated current / Rated cross section		18 A / 2.5 mm ²	20 A / 10 AWG		
Rated short-time withstand current (1s)		300 A			
Rated voltage		400 V	150 V		
Impulse withstand voltage		6000 V			
Protection		IP20	NEMA 1		

The connecting capacity data for one Rigid: Solid/Stranded, or one Flexible conductor (when applicable) is a mandatory information required by IEC, UL and CSA standards (Copper conductors). All other data are provided as supplementary information only. For more details, please consult our CB, UL or CSA certificates and technical datasheet available on <http://www.TE.com>

--	--	--	--	--

Accessories

Description	Color	Type	Part Number	Pkg qty	Weight (1 pce) g
1 End stops	Dark grey <input type="checkbox"/>	BAM4	1SNK900001R0000	50	14.00
2 Jumper bars	Orange <input type="checkbox"/>	JB6-2	1SNK906302R0000	50	1.30
		JB6-3	1SNK906303R0000	50	2.10
		JB6-4	1SNK906304R0000	50	2.90
		JB6-5	1SNK906305R0000	50	3.60
		JB6-10	1SNK906310R0000	20	7.40
3 Test adapters	Dark grey <input type="checkbox"/>	TP2	1SNK900203R0000	20	1.70
		TP4	1SNK900205R0000	20	2.40
4 Test connectors	Dark grey <input type="checkbox"/>	TC5-R1	1SNK900201R0000	10	5.20
5 Spacers	Dark grey <input type="checkbox"/>	ES-TC6	1SNK900105R0000	10	0.80
6 Component plugs	Dark grey <input type="checkbox"/>	PG5	1SNK900401R0000	20	3.50
7 Disconnect plugs	Orange <input type="checkbox"/>	PG5-R1	1SNK900402R0000	20	3.50
8 Terminal block markers	White <input type="checkbox"/>	MG-CPM 13 41791	1SNB041791R0612	1680	0.27
		MC612	1SNK150000R0000	22	10.00
		MC612PA	1SNK159999R0000	20	11.00
Universal wire markers holder	Grey <input type="checkbox"/>	UMH	1SNK900611R0000	10	0.20

Complete list of accessories is indicated in the terminal block datasheet including end stops. Some accessories such as jumper bars may modify the terminal block's ratings: Complete information available in the accessories section of the catalog.

Technical data valid for copper conductors only.

ZS4-SP-T2-R1 screw clamp terminal blocks

Disconnect with plug - with test socket - 6 mm 0.236 in spacing

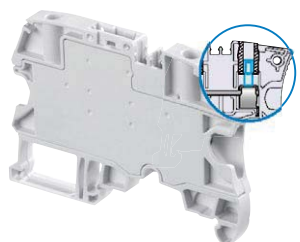

1SNK16 1037TC014

ZS4-SP-T2-R1

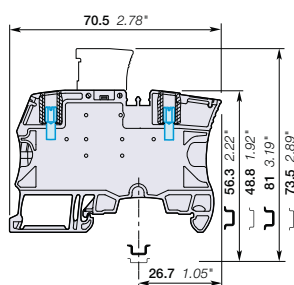

6 mm 0.236 in spacing

Description

- Ease your test operations with the 2 built-in test sockets DIA 2 mm 0.079 in,
- Save time with our screwless component holder plug,
- Simplify the distribution between feed-through and disconnect circuits thanks to the two aligned jumper channels.

Ordering details

Description	Color	Type	Part Number	Pkg qty	Weight (1 pce)
Disconnect Profile aligned with ZS4-SF, with 2 test sockets DIA 2 mm 0.079 in, plug delivered separately	Grey <input type="checkbox"/>	ZS4-SP-T2-R1	1SNK506314R0000	50	14.20

Main technical data

Connecting capacity		IEC	UL - CSA	Mounting instructions	
1 conductor per clamp	Rigid: Solid/Stranded	0.2 ... 4 mm²	24 ... 10 AWG	Rail	TH 35-7.5, TH 35-15
	Flexible without ferrule	0.22 ... 4 mm²		Wire stripping length	10.5 mm 0.412 in
	Flexible with non insulated ferrule	0.22 ... 4 mm²	24 ... 12 AWG		
	Flexible with insulated ferrule	0.22 ... 4 mm²	24 ... 12 AWG		
	Gauge	A3-B3			
2 conductors per clamp	Rigid: Solid/Stranded	0.2 ... 1.5 mm²	24 ... 16 AWG	Tool	Flat screwdriver Ø 3.5 mm Ø 0.138 in
	Flexible without ferrule	0.2 ... 1.5 mm²			
	Flexible with twin ferrule	0.22 ... 1.5 mm²	24 ... 16 AWG		
Rated current / Rated cross section		18 A / 2.5 mm²	20 A / 10 AWG		
Rated short-time withstand current (1s)		300 A		Torque	0.6 Nm ± 0.1 5.31 lb.in ± 0.85
Rated voltage		400 V	150 V		
Impulse withstand voltage		6000 V			
Protection		IP20	NEMA 1		

The connecting capacity data for one Rigid: Solid/Stranded, or one Flexible conductor (when applicable) is a mandatory information required by IEC, UL and CSA standards (Copper conductors). All other data are provided as supplementary information only. For more details, please consult our CB, UL or CSA certificates and technical datasheet available on <http://www.TE.com>

CE	RoHS	UL US	CSA	EAC

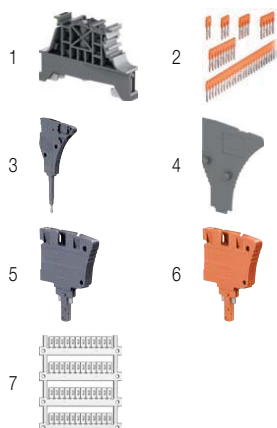

Accessories

Description	Color	Type	Part Number	Pkg qty	Weight (1 pce)	
1 End stops	Dark grey <input checked="" type="checkbox"/>	BAM4	1SNK900001R0000	50	14.00	
2 Jumper bars	Orange <input checked="" type="checkbox"/>	2 poles	JB6-2	1SNK906302R0000	50	1.30
		3 poles	JB6-3	1SNK906303R0000	50	2.10
		4 poles	JB6-4	1SNK906304R0000	50	2.90
		5 poles	JB6-5	1SNK906305R0000	50	3.60
		10 poles	JB6-10	1SNK906310R0000	20	7.40
3 Test connectors	Dark grey <input checked="" type="checkbox"/>	TC5-R1	1SNK900201R0000	10	5.20	
4 Spacers	Dark grey <input checked="" type="checkbox"/>	ES-TC6	1SNK900105R0000	10	0.80	
5 Component plugs	Dark grey <input checked="" type="checkbox"/>	PG5	1SNK900401R0000	20	3.50	
6 Disconnect plugs	Orange <input checked="" type="checkbox"/>	PG5-R1	1SNK900402R0000	20	3.50	
7 Terminal block markers	White <input type="checkbox"/>	Blank marker	MG-CPM 13 41791	1SNB041791R0612	1680	0.27
		Blank card	MC612	1SNK150000R0000	22	10.00
			MC612PA	1SNK159999R0000	20	11.00
	Universal wire markers holder	Grey <input type="checkbox"/>	UMH	1SNK900611R0000	10	0.20

Complete list of accessories is indicated in the terminal block datasheet including end stops. Some accessories such as jumper bars may modify the terminal block's ratings: Complete information available in the accessories section of the catalog.

Technical data valid for copper conductors only.

ZS10-SP screw clamp terminal blocks

Disconnect with plug - 8 mm 0.315 in spacing



ZS10-SP

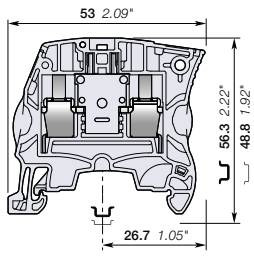

8 mm 0.315 in spacing

Description

- Save time with our screwless component holder plug,
- Same profile as ZS10 feed-through terminal block for aligned marking and identical end section use.

Ordering details

Description	Color	Type	Part Number	Pkg qty	Weight (1 pce) g
Disconnect Profile aligned with ZS10	Grey <input type="checkbox"/>	ZS10-SP	1SNK508316R0000	50	8.60

Main technical data

Connecting capacity		IEC	UL - CSA	Mounting instructions	
1 conductor per clamp	Rigid: Solid/Stranded	0.2 ... 10 mm ²	24 ... 6 AWG	Rail	TH 35-7.5, TH 35-15
	Flexible without ferrule	0.22 ... 10 mm ²	24 ... 8 AWG	Wire stripping length	12 mm 0.472 in
	Flexible with non insulated ferrule	0.22 ... 10 mm ²	24 ... 8 AWG	Tool	Flat screwdriver Ø 4 mm Ø 0.157 in
	Flexible with insulated ferrule	0.22 ... 6 mm ²	24 ... 8 AWG		
Gauge		A5-B5		Torque	1.3 Nm ± 0.3 11.5 lb.in ± 2.65
2 conductors per clamp	Rigid: Solid/Stranded	0.5 ... 4 mm ²	20 ... 12 AWG		
	Flexible without ferrule	0.5 ... 4 mm ²	20 ... 12 AWG		
	Flexible with twin ferrule	0.5 ... 4 mm ²	20 ... 12 AWG		
Rated current / Rated cross section		18 A / 2.5 mm ²	18 A / 6 AWG		
Maximum current / Maximum cross section		18 A / 10 mm ²			
Rated short-time withstand current (1s)		300 A			
Rated voltage		630 V	300 V		
Impulse withstand voltage		6000 V			
Protection		IP20		NEMA 1	

The connecting capacity data for one Rigid: Solid/Stranded, or one Flexible conductor (when applicable) is a mandatory information required by IEC, UL and CSA standards (Copper conductors). All other data are provided as supplementary information only. For more details, please consult our CB, UL or CSA certificates and technical datasheet available on <http://www.TE.com>

CE	RoHS	RoHS	USR	CSA	ERC	EAC
----	------	------	-----	-----	-----	-----

Accessories

Description	Color	Type	Part Number	Pkg qty	Weight (1 pce) g
1 End stops 10 mm 0.394 in	Dark grey <input checked="" type="checkbox"/>	BAM4	1SNK900001R0000	50	14.00
2 End sections 2.2 mm 0.087 in	Dark grey <input checked="" type="checkbox"/>	ES4	1SNK505910R0000	20	2.20
3 Component plugs Components in series with circuit	Dark grey <input checked="" type="checkbox"/>	PG5	1SNK900401R0000	20	3.50
4 Disconnect plugs Equipped with linking bar	Orange <input checked="" type="checkbox"/>	PG5-R1	1SNK900402R0000	20	3.50
5 Terminal block markers	White <input type="checkbox"/>	MG-CPM 13 41791	1SNB041791R0612	1680	0.27
		MC812	1SNK160000R0000	22	10.00
		MC812PA	1SNK169999R0000	20	14.00
Universal wire markers holder	Grey <input type="checkbox"/>	UMH	1SNK900611R0000	10	0.20

Complete list of accessories is indicated in the terminal block datasheet including end stops. Some accessories such as jumper bars may modify the terminal block's ratings: Complete information available in the accessories section of the catalog.

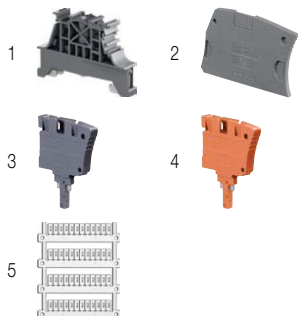

Technical data valid for copper conductors only.



SNK series, terminal blocks

Fuse protection



Optimize your control circuit protection

Our SNK series fuse terminal blocks offer a full set of features and functions to protect your control circuits with efficiency and reliability.

All terminal blocks complies with the latest evolution of the international standards IEC 60947-7-3 ("Ancillary equipment safety requirements for fuse terminal blocks.") which fixes precise temperature constraint for short-circuit and overload protection (information in the catalogue pages related to the products).

Qualified for worldwide markets and applications

Eco-designed according to international environmental standards in sustainable development.



Select the right fuse holder for the right application

1 standard applications

The standard fuse holders feature compact dimensions while offering compatibility with 5 x 20 and 5 x 25 mm fuses. double deck terminal blocks allow efficient space reduction for panels with space constraints.

2 Expert for convenient circuit distribution

The expert fuse holders are equipped with two central jumper channels for convenient common distribution and are aligned with feed-through and disconnect terminal blocks. They facilitate alternated potential distribution and reduce wiring.

Additional features for easy trouble shooting and testing

Performant blown fuse indicators

Low leakage current (< 0.5 mA) allows the protection of low current circuits such as PLC's inputs without any risk of circuit disturbances.

Large voltage range (24/110 V and 110/250 V AC/DC) reduces the number of variants and allows adaptation to worldwide applications (24/110 V range covers North american market needs).

Easy testing

Some terminal blocks are equipped with Dia 2 mm built-in test socket screws for circuit testing while respecting the IP20 touch proof protection.



1
5x20 and 5x25 mm fuses
Compact and high density



2
5x20 and 6.3x32 mm fuses
Easy potential distribution

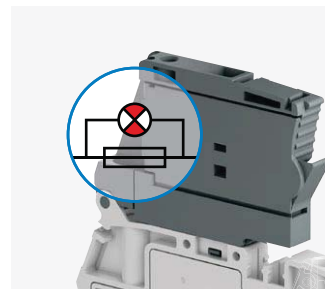

Low leakage current blown fuse indicator.
Large voltage range: (24/110 V and 110/250 V AC and DC)

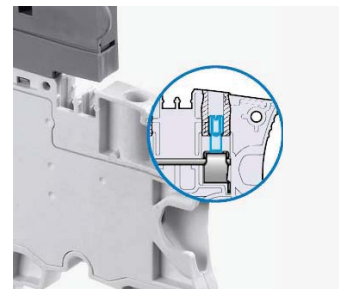

Convenient testing through built in test socket screws

SNK series, terminal blocks

Marshalling cabinets application

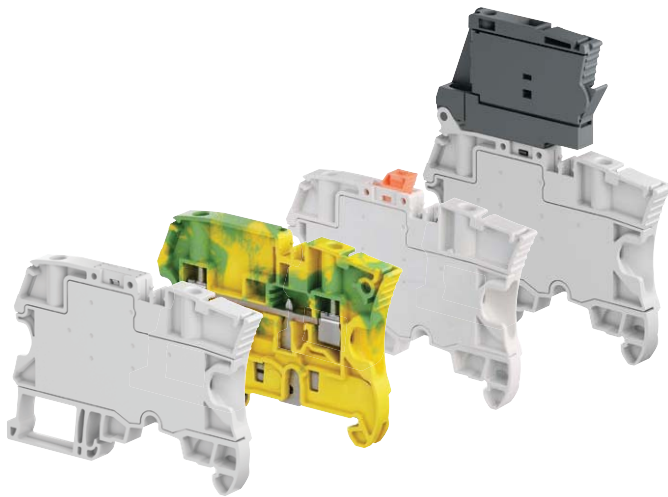

The smart choice for process automation

Large process automation applications typically require the use of a large number of digital or analog signals and sensors. Indeed, marshalling cabinets ensure an important cross wiring function, since the incoming field signal and the channel quantity of the I/O card of the controller (DCS, large PLC's) is always different. They facilitate the maintenance operations and ease the system modifications.

SNK aligned terminal blocks offering:

SNK series now features a full set of aligned terminal blocks matching the marshalling panels typical configurations. Fuse, disconnect, feed-through and ground terminal blocks with identical profile are providing compact and convenient solution. With only 6 mm spacing, two aligned screwless jumper channels, central large marking as well as aligned conductor entries, they are perfectly adapted to alternative potential distribution while still easy to connect.

Typical marshalling configurations

Digital signals

Popular potential distribution via double center channel.

Disconnect functions equipped with test points allow total isolation of circuits, ease circuit testing during start-up, test and maintenance operations.

Analog

Potential distribution for analog signals. Ground terminal blocks allow reliable connection of cable shields to the ground sparing the use of external shield bar.

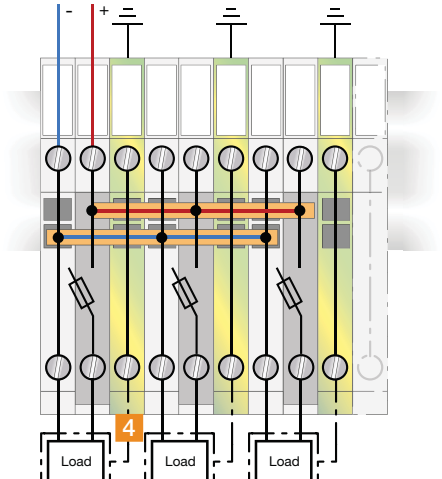
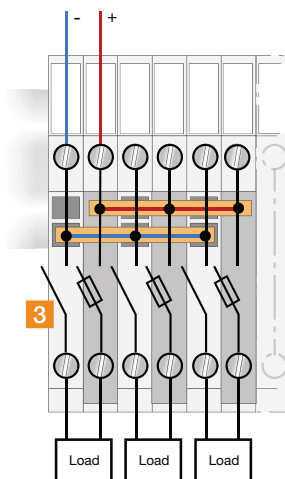
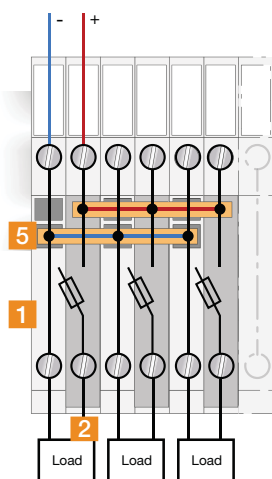

ZS4-SF1 screw clamp terminal blocks

For 5 x 20 and 5 x 25 fuses - 8 mm 0.315 in spacing



ZS4-SF1

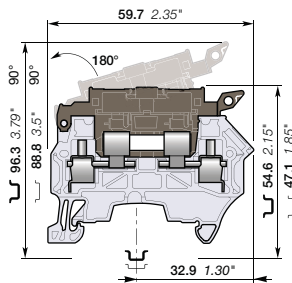

8 mm 0.315 in spacing

Description

Protect your circuit with 5x25 and 5x20 fuse terminal blocks, compliant with IEC 60947-7-3 standard (fuse not supplied with the terminal blocks).

Ordering details

Description	Color	Type	Part Number	Pkg qty	Weight (1 pce) g
Fuse	Grey, dark grey	ZS4-SF1	1SNK508410R0000	50	13.30
	Orange, dark grey	ZS4-SF1-OR	1SNK508430R0000	50	13.30

Main technical data

Connecting capacity		IEC	UL - CSA	Mounting instructions	
1 conductor per clamp	Rigid: Solid/Stranded	0.2 ... 4 mm ²	24 ... 10 AWG	Rail	TH 35-7.5, TH 35-15
	Flexible without ferrule	0.22 ... 4 mm ²		Wire stripping length	11 mm 0.432 in
	Flexible with non insulated ferrule	0.22 ... 4 mm ²	24 ... 12 AWG		
	Flexible with insulated ferrule	0.22 ... 4 mm ²	24 ... 12 AWG		
	Gauge	A3-B3			
2 conductors per clamp	Rigid: Solid/Stranded	0.2 ... 2.5 mm ²	24 ... 14 AWG	Tool	Flat screwdriver Ø 3.5 mm Ø 0.138 in
	Flexible without ferrule	0.2 ... 2.5 mm ²	24 ... 14 AWG		
	Flexible with twin ferrule	0.22 ... 2.5 mm ²	24 ... 14 AWG		
Rated current / Rated cross section		6.3 A / 4 mm ²	10 A / 10 AWG	Torque	0.6 Nm ± 0.1 5.31 lb.in ± 0.885
Rated voltage		630 V	300 V		
Impulse withstand voltage		8000 V			
Protection		IP20	NEMA 1		

Separate arrangement		Assembly composed of 1 fuse terminal block in between non fuse terminal blocks	Overload and short-circuit protection	2.5 W
			Exclusive short-circuit protection	4 W
Compound arrangement		Assembly composed of 5 fuse terminal blocks	Overload and short-circuit protection	1.6 W
			Exclusive short-circuit protection	4 W

The connecting capacity data for one Rigid: Solid/Stranded, or one Flexible conductor (when applicable) is a mandatory information required by IEC, UL and CSA standards (Copper conductors). All other data are provided as supplementary information only. For more details, please consult our CB, UL or CSA certificates and technical datasheet available on <http://www.TE.com>

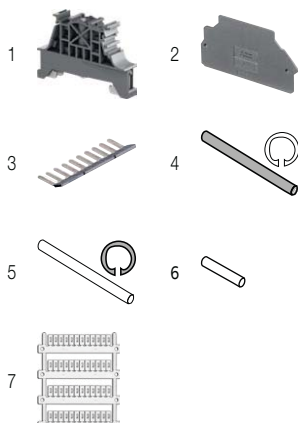
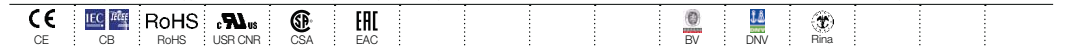

Accessories

Description	Color	Type	Part Number	Pkg qty	Weight (1 pce) g
1 End stops	Dark grey	BAM4	1SNK900001R0000	50	14.00
2 End sections	Dark grey	ES4-SF	1SNK508960R0000	20	1.80
3 Lateral jumper bars	Grey	PC81-10	1SNA173523R1100	10	5.00
4 Assembly rods		TGA8	1SNA168672R1100	10	1.00
		TGA8	1SNA168673R1200	10	1.50
		TGA8	1SNA168674R1300	10	2.00
5 Spring retaining Rings		ANT	1SNA168675R1400	10	
6 Neutral cartridge		CN5	1SNA179371R1600	10	3.9
7 Terminal block markers	White	MG-CPM 13 41791	1SNB041791R0612	1680	0.27
		MC812	1SNK160000R0000	22	10.00
		MC812PA	1SNK169999R0000	20	14.00
	Grey	UMH	1SNK900611R0000	10	0.20

Complete list of accessories is indicated in the terminal block datasheet including end stops. Some accessories such as jumper bars may modify the terminal block's ratings: Complete information available in the accessories section of the catalog.

Technical data valid for copper conductors only.

ZS4-SF1-T screw clamp terminal blocks

For 5 x 20 and 5 x 25 fuses - with test socket - 8 mm 0.315 in spacing

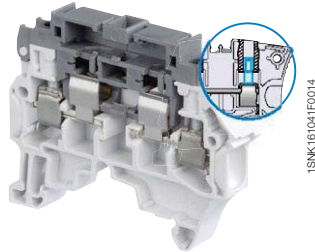

ZS4-SF1-T

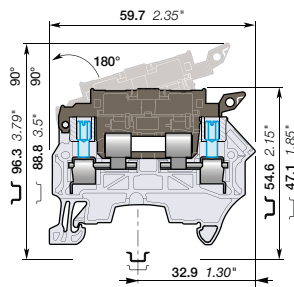

8 mm 0.315 in spacing

Description

- Protect your circuit with 5x25 and 5x20 fuse terminal blocks (fuse not supplied with the terminal blocks),
- Compliant with IEC 60947-7-3 standard,
- With built in test sockets.

Ordering details

Description	Color	Type	Part Number	Pkg qty	Weight (1 pce) g
Fuse With 2 test sockets DIA 2 mm 0.079 in	Grey, dark grey	ZS4-SF1-T2	1SNK508411R0000	50	13.30

Main technical data

Connecting capacity		IEC	UL - CSA	Rail	Mounting instructions
1 conductor per clamp	Rigid: Solid/Stranded	0.2 ... 4 mm ²	24 ... 10 AWG	Wire stripping length	
	Flexible without ferrule	0.22 ... 4 mm ²	24 ... 12 AWG		
	Flexible with non insulated ferrule	0.22 ... 4 mm ²	24 ... 12 AWG		
	Flexible with insulated ferrule	0.22 ... 4 mm ²	24 ... 12 AWG		
Gauge		A3-B3		Tool	Flat screwdriver Ø 3.5 mm Ø 0.138 in
2 conductors per clamp	Rigid: Solid/Stranded	0.2 ... 2.5 mm ²	24 ... 14 AWG		
	Flexible without ferrule	0.2 ... 2.5 mm ²	24 ... 14 AWG		
Flexible with twin ferrule		0.22 ... 2.5 mm ²	24 ... 14 AWG	Torque	0.6 Nm ± 0.1 5.31 lb.in ± 0.885
Rated current / Rated cross section		6.3 A / 4 mm ²	10 A / 10 AWG		
Rated voltage		630 V	300 V		
Impulse withstand voltage		8000 V			
Protection		IP20	NEMA 1		

Separate arrangement		Assembly composed of 1 fuse terminal block in between non fuse terminal blocks	Overload and short-circuit protection	2.5 W
			Exclusive short-circuit protection	4 W
Compound arrangement		Assembly composed of 5 fuse terminal blocks	Overload and short-circuit protection	1.6 W
			Exclusive short-circuit protection	4 W

The connecting capacity data for one Rigid: Solid/Stranded, or one Flexible conductor (when applicable) is a mandatory information required by IEC, UL and CSA standards (Copper conductors). All other data are provided as supplementary information only. For more details, please consult our CB, UL or CSA certificates and technical datasheet available on <http://www.TE.com>

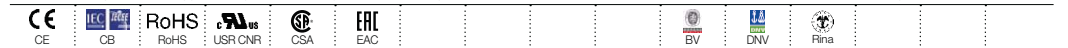

Accessories

Description	Color	Type	Part Number	Pkg qty	Weight (1 pce) g	
1 End stops	Dark grey	BAM4	1SNK90001R0000	50	14.00	
2 End sections	Dark grey	ES4-SF	1SNK508960R0000	20	1.80	
3 Lateral jumper bars	Grey	PC81-10	1SNA173523R1100	10	5.00	
4 Assembly rods		2 poles	TGA8	1SNA168672R1100	10	1.00
		3 poles	TGA8	1SNA168673R1200	10	1.50
		4 poles	TGA8	1SNA168674R1300	10	2.00
5 Spring retaining Rings		ANT	1SNA168675R1400	10		
6 Neutral cartridge		CN5	1SNA179371R1600	10	3.9	
7 Terminal block markers	White	Blank marker	MG-CPM 13 41791	1SNB041791R0612	1680	0.27
		Blank card	MC812	1SNK160000R0000	22	10.00
			MC812PA	1SNK169999R0000	20	14.00
	Universal wire markers holder	Grey	UMH	1SNK900611R0000	10	0.20

Complete list of accessories is indicated in the terminal block datasheet including end stops. Some accessories such as jumper bars may modify the terminal block's ratings. Complete information available in the accessories section of the catalog.

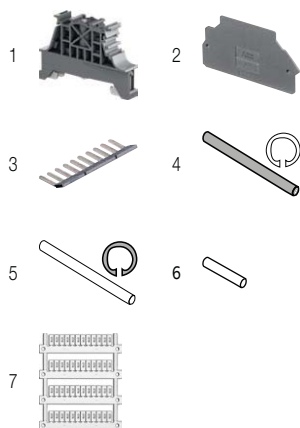

Technical data valid for copper conductors only.

ZS4-SF1-R screw clamp terminal blocks

For 5 x 20 and 5 x 25 fuses - with blown fuse indicator - 8 mm 0.315 in spacing

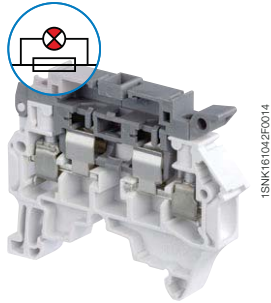

ZS4-SF1-R

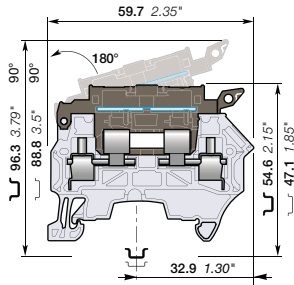

8 mm 0.315 in spacing

Description

- Protect your circuit with 5x25 and 5x20 fuse terminal blocks (fuse not supplied with the terminal blocks),
- Compliant with IEC 60947-7-3 standard,
- Quickly identify the defective circuit thanks to the blown fuse indicator (with leakage current < 0.5 mA).

Ordering details

Description	Color	Type	Part Number	Pkg qty	Weight (1 pce) g
Fuse With blown fuse indicator 115 ... 250 V AC / DC	Grey, dark grey	ZS4-SF1-R3	1SNK508414R0000	50	13.30
With blown fuse indicator 24 ... 110 V AC / DC		ZS4-SF1-R1	1SNK508412R0000	50	13.30

Main technical data

Connecting capacity	IEC	UL - CSA	Mounting instructions
1 conductor per clamp	Rigid: Solid/Stranded Flexible without ferrule Flexible with non insulated ferrule Flexible with insulated ferrule Gauge A3-B3	0.2 ... 4 mm ² 0.22 ... 4 mm ² 0.22 ... 4 mm ² 0.22 ... 4 mm ²	24 ... 10 AWG 24 ... 12 AWG 24 ... 12 AWG
2 conductors per clamp	Rigid: Solid/Stranded Flexible without ferrule Flexible with twin ferrule	0.2 ... 2.5 mm ² 0.2 ... 2.5 mm ² 0.22 ... 2.5 mm ²	24 ... 14 AWG 24 ... 14 AWG 24 ... 14 AWG
Rated current / Rated cross section		6.3 A / 4 mm ²	10 A / 10 AWG
Rated voltage	630 V	300 V	
Impulse withstand voltage	8000 V		
Protection	IP20	NEMA 1	

Separate arrangement		Assembly composed of 1 fuse terminal block in between non fuse terminal blocks	Overload and short-circuit protection	2.5 W
Compound arrangement		Assembly composed of 5 fuse terminal blocks	Exclusive short-circuit protection	4 W
			Overload and short-circuit protection	1.6 W
			Exclusive short-circuit protection	4 W

The connecting capacity data for one Rigid: Solid/Stranded, or one Flexible conductor (when applicable) is a mandatory information required by IEC, UL and CSA standards (Copper conductors). All other data are provided as supplementary information only. For more details, please consult our CB, UL or CSA certificates and technical datasheet available on <http://www.TE.com>

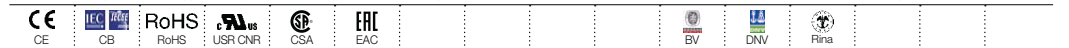

Accessories

Description	Color	Type	Part Number	Pkg qty	Weight (1 pce) g
1 End stops	Dark grey	BAM4	1SNK900001R0000	50	14.00
2 End sections	Dark grey	ES4-SF	1SNK508960R0000	20	1.80
3 Lateral jumper bars	Grey	PC81-10	1SNA173523R1100	10	5.00
4 Assembly rods		TGA8	1SNA168672R1100	10	1.00
		TGA8	1SNA168673R1200	10	1.50
		TGA8	1SNA168674R1300	10	2.00
5 Spring retaining Rings		ANT	1SNA168675R1400	10	
6 Terminal block markers	White	MG-CPM 13 41791	1SNB041791R0612	1680	0.27
		MC812	1SNK160000R0000	22	10.00
		MC812PA	1SNK169999R0000	20	14.00
	Grey	UMH	1SNK900611R0000	10	0.20

Complete list of accessories is indicated in the terminal block datasheet including end stops. Some accessories such as jumper bars may modify the terminal block's ratings: Complete information available in the accessories section of the catalog.

Technical data valid for copper conductors only.

ZS4-SF1-R screw clamp terminal blocks

For 5 x 20 and 5 x 25 fuses - with blown fuse indicator and test sockets - 8 mm 0.315 in spacing

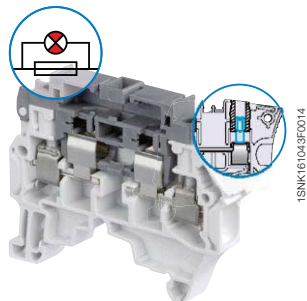

ZS4-SF1-R

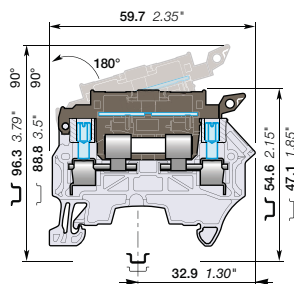

8 mm 0.315 in spacing

Description

- Protect your circuit with 5x25 and 5x20 fuse terminal blocks (fuse not supplied with the terminal blocks),
- Compliant with IEC 60947-7-3 standard,
- Ease the test with built-in test sockets,
- Quickly identify the defective circuit thanks to the blown fuse indicator (with leakage current < 0.5 mA).

Ordering details

Description	Color	Type	Part Number	Pkg qty	Weight (1 pce) g
Fuse With blown fuse indicator 115 ... 250 V AC / DC and 2 test sockets DIA 2 mm 0.079 in	Grey, dark grey	ZS4-SF1-R4	1SNK508415R0000	50	13.30
With blown fuse indicator 24 ... 110 V AC / DC and 2 test sockets DIA 2 mm 0.079 in		ZS4-SF1-R2	1SNK508413R0000	50	13.30

Main technical data

Connecting capacity	IEC	UL - CSA	Mounting instructions		
1 conductor per clamp	Rigid: Solid/Stranded	0.2 ... 4 mm ²	24 ... 10 AWG	Rail	TH 35-7.5, TH 35-15
	Flexible without ferrule	0.22 ... 4 mm ²		Wire stripping length	11 mm 0.432 in
	Flexible with non insulated ferrule	0.22 ... 4 mm ²	24 ... 12 AWG	Tool	Flat screwdriver Ø 3.5 mm Ø 0.138 in
	Flexible with insulated ferrule	0.22 ... 4 mm ²	24 ... 12 AWG		
	Gauge	A3-B3		Torque	0.6 Nm ± 0.1 5.31 lb.in ± 0.885
2 conductors per clamp	Rigid: Solid/Stranded	0.2 ... 2.5 mm ²	24 ... 14 AWG		
	Flexible without ferrule	0.2 ... 2.5 mm ²			
	Flexible with twin ferrule	0.22 ... 2.5 mm ²	24 ... 14 AWG		
Rated current / Rated cross section		6.3 A / 4 mm ²	10 A / 10 AWG		
Rated voltage		630 V	300 V		
Impulse withstand voltage		8000 V			
Protection		IP20	NEMA 1		

Separate arrangement		Assembly composed of 1 fuse terminal block in between non fuse terminal blocks	Overload and short-circuit protection	2.5 W
			Exclusive short-circuit protection	4 W
Compound arrangement		Assembly composed of 5 fuse terminal blocks	Overload and short-circuit protection	1.6 W
			Exclusive short-circuit protection	4 W

The connecting capacity data for one Rigid: Solid/Stranded, or one Flexible conductor (when applicable) is a mandatory information required by IEC, UL and CSA standards (Copper conductors). All other data are provided as supplementary information only. For more details, please consult our CB, UL or CSA certificates and technical datasheet available on <http://www.TE.com>

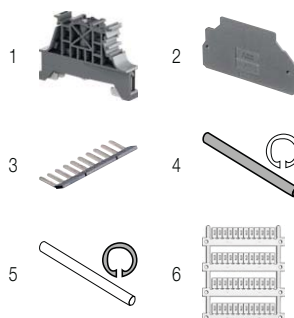
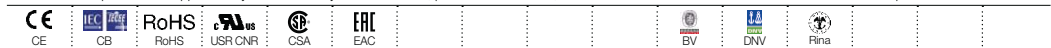

Accessories

Description	Color	Type	Part Number	Pkg qty	Weight (1 pce) g	
1 End stops 10 mm 0.394 in	Dark grey	BAM4	1SNK90001R0000	50	14.00	
2 End sections 1.5 mm 0.059 in	Dark grey	ES4-SF	1SNK508960R0000	20	1.80	
3 Lateral jumper bars 10 poles 35 A (IEC)	Grey	PC81-10	1SNA173523R1100	10	5.00	
4 Assembly rods		TGA8	1SNA168672R1100	10	1.00	
		TGA8	1SNA168673R1200	10	1.50	
		TGA8	1SNA168674R1300	10	2.00	
5 Spring retaining Rings		ANT	1SNA168675R1400	10		
6 Terminal block markers	Blank marker	White	MG-CPM 13 41791	1SNB041791R0612	1680	0.27
	Blank card		MC812	1SNK160000R0000	22	10.00
			MC812PA	1SNK169999R0000	20	14.00
	Universal wire markers holder	Grey	UMH	1SNK900611R0000	10	0.20

Complete list of accessories is indicated in the terminal block datasheet including end stops. Some accessories such as jumper bars may modify the terminal block's ratings: Complete information available in the accessories section of the catalog.

Technical data valid for copper conductors only.

ZS4-R1 screw clamp terminal blocks

Feed-through - 8 mm 0.315 in spacing



1SNK161048FC014

ZS4-R1

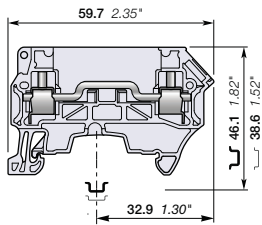

8 mm 0.315 in spacing

Description

Simplify the alternated feed-through and fuse circuits operations:

- With the same profile as the ZS4-SF1, the wiring of the alternated feed-through and fuse circuits is easier.

Ordering details

Description	Color	Type	Part Number	Pkg qty	Weight (1 pce) g
Feed-through Profile aligned with ZS4-SF1	Grey <input type="checkbox"/>	ZS4-R1	1SNK508013R0000	50	11.00

Main technical data

Connecting capacity		IEC	UL - CSA	Mounting instructions	
				Rail	TH 35-7.5, TH 35-15
1 conductor per clamp	Rigid: Solid/Stranded	0.2 ... 4 mm ²	24 ... 10 AWG	Wire stripping length	11 mm 0.432 in
	Flexible without ferrule	0.22 ... 4 mm ²			
	Flexible with non insulated ferrule	0.22 ... 4 mm ²	24 ... 12 AWG		
	Flexible with insulated ferrule	0.22 ... 4 mm ²	24 ... 12 AWG		
Gauge		A3-B3			
2 conductors per clamp	Rigid: Solid/Stranded	0.2 ... 2.5 mm ²	24 ... 14 AWG	Tool	Flat screwdriver Ø 3.5 mm Ø 0.138 in
	Flexible without ferrule	0.2 ... 2.5 mm ²			
	Flexible with twin ferrule	0.22 ... 2.5 mm ²	24 ... 14 AWG		
Rated current / Rated cross section		24 A / 2.5 mm ²	26 A / 10 AWG		
Rated short-time withstand current (1s)		300 A		Torque	0.6 Nm ± 0.1 5.31 lb.in ± 0.885
Short Circuit Current Rating (with specific conditions)					
Rated voltage		800 V	300 V		
Impulse withstand voltage		6000 V			
Protection		IP20	NEMA 1		

The connecting capacity data for one Rigid: Solid/Stranded, or one Flexible conductor (when applicable) is a mandatory information required by IEC, UL and CSA standards (Copper conductors). All other data are provided as supplementary information only. For more details, please consult our CB, UL or CSA certificates and technical datasheet available on <http://www.TE.com>

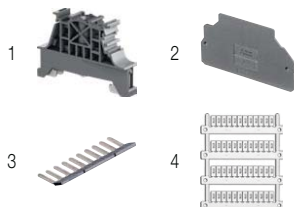

Accessories

Description	Color	Type	Part Number	Pkg qty	Weight (1 pce) g
1 End stops 10 mm 0.394 in	Dark grey <input checked="" type="checkbox"/>	BAM4	1SNK900001R0000	50	14.00
2 End sections 1.5 mm 0.059 in	Dark grey <input checked="" type="checkbox"/>	ES4-SF	1SNK508960R0000	20	1.80
3 Lateral jumper bars 10 poles 35 A (IEC)	Grey <input type="checkbox"/>	PC81-10	1SNA173523R1100	10	5.00
4 Terminal block markers	White <input type="checkbox"/>	MG-CPM 13 41791	1SNB041791R0612	1680	0.27
		MC812	1SNK160000R0000	22	10.00
		MC812PA	1SNK169999R0000	20	14.00
Universal wire markers holder	Grey <input type="checkbox"/>	UMH	1SNK900611R0000	10	0.20

Complete list of accessories is indicated in the terminal block datasheet including end stops. Some accessories such as jumper bars may modify the terminal block's ratings. Complete information available in the accessories section of the catalog.

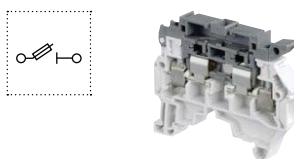

Fuse screw clamp terminal blocks

Description	Color	Type	Part Number	Pkg qty	Weight (1 pce) g
Fuse	Grey, dark grey <input type="checkbox"/>	ZS4-SF1	1SNK508410R0000	50	13.30

Technical data valid for copper conductors only.

ZS4-S-R3 screw clamp terminal blocks

Disconnect with lever - 8 mm 0.315 in spacing

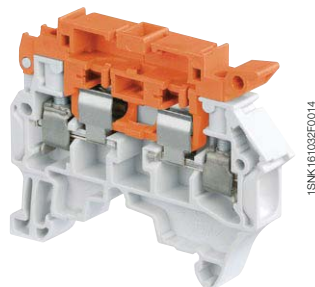

ZS4-S-R3

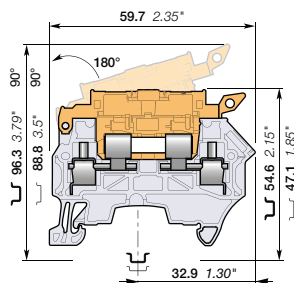

8 mm 0.315 in spacing

Description

Simplify the disconnect operations for the disconnect terminal blocks installed next to fuse terminal blocks ZS4-SF1:

- With the same profile as ZS4-SF1, the ZS4-S-R3 disconnect lever is easily operated by hand and the wiring of the alternated disconnect and fuse circuits is easier,
- Neutral cartridge CN5 5x25 included.

Ordering details

Description	Color	Type	Part Number	Pkg qty	Weight (1 pce) g
Disconnect Profile aligned with ZS4-SF1	Grey, orange	ZS4-S-R3	1SNK508416R0000	50	13.30
	Grey, blue	ZS4-S-R3-T2	1SNK508419R0000	50	13.30

Main technical data

Connecting capacity		IEC	UL - CSA	Mounting instructions	
1 conductor per clamp	Rigid: Solid/Stranded	0.2 ... 4 mm²	24 ... 10 AWG	Rail	TH 35-7.5, TH 35-15
	Flexible without ferrule	0.22 ... 4 mm²		Wire stripping length	11 mm 0.432 in
	Flexible with non insulated ferrule	0.22 ... 4 mm²	24 ... 12 AWG		
	Flexible with insulated ferrule	0.22 ... 4 mm²	24 ... 12 AWG		
Gauge		A3-B3			
2 conductors per clamp	Rigid: Solid/Stranded	0.2 ... 2.5 mm²	24 ... 14 AWG	Tool	Flat screwdriver Ø 3.5 mm Ø 0.138 in
	Flexible without ferrule	0.2 ... 2.5 mm²			
	Flexible with twin ferrule	0.22 ... 2.5 mm²	24 ... 14 AWG		
Rated current / Rated cross section		18 A / 2.5 mm²	18 A / 10 AWG	Torque	0.6 Nm ± 0.1 5.31 lb.in ± 0.885
Maximum current / Maximum cross section		18 A / 4 mm²			
Rated short-time withstand current (1s)		300 A			
Rated voltage		630 V	300 V		
Impulse withstand voltage		6000 V			
Protection		IP20	NEMA 1		

Recommendation for best usage: in horizontal assemblies, disconnect terminal blocks should be mounted with fixed foot on top (power side) so that the disconnect lever does not partially close through gravity. Furthermore, as specified per IEC 60947-7-1, disconnect terminal blocks are intended to be used for temporary disconnection at zero potential and at no load.

The connecting capacity data for one Rigid: Solid/Stranded, or one Flexible conductor (when applicable) is a mandatory information required by IEC, UL and CSA standards (Copper conductors). All other data are provided as supplementary information only. For more details, please consult our CB, UL or CSA certificates and technical datasheet available on <http://www.TE.com>

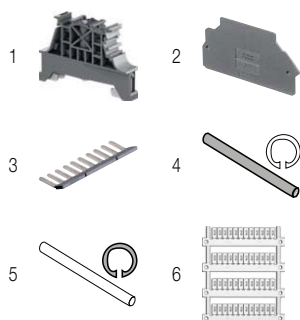
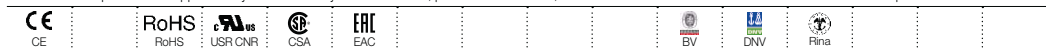

Accessories

Description	Color	Type	Part Number	Pkg qty	Weight (1 pce) g	
1 End stops 10 mm 0.394 in	Dark grey	BAM4	1SNK900001R0000	50	14.00	
2 End sections 1.5 mm 0.059 in	Dark grey	ES4-SF	1SNK508960R0000	20	1.80	
3 Lateral jumper bars 10 poles 35 A (IEC)	Grey	PC81-10	1SNA173523R1100	10	5.00	
4 Assembly rods		2 poles	TGA8	1SNA168672R1100	10	1.00
		3 poles	TGA8	1SNA168673R1200	10	1.50
		4 poles	TGA8	1SNA168674R1300	10	2.00
5 Spring retaining Rings		ANT	1SNA168675R1400	10		
6 Terminal block markers	White	Blank marker	MG-OPM 13 41791	1SNB041791R0612	1680	0.27
		Blank card	MC812	1SNK160000R0000	22	10.00
			MC812PA	1SNK169999R0000	20	14.00
		Universal wire markers holder	UMH	1SNK900611R0000	10	0.20

Complete list of accessories is indicated in the terminal block datasheet including end stops.

Some accessories such as jumper bars may modify the terminal block's ratings: Complete information available in the accessories section of the catalog.

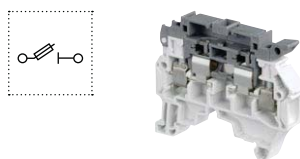

Fuse screw clamp terminal blocks

Description	Color	Type	Part Number	Pkg qty	Weight (1 pce) g
Fuse	Grey, dark grey	ZS4-SF1	1SNK508410R0000	50	13.30

Technical data valid for copper conductors only.

ZS4-SF screw clamp terminal blocks

For 5 x 20 fuses - 6 mm 0.236 in spacing

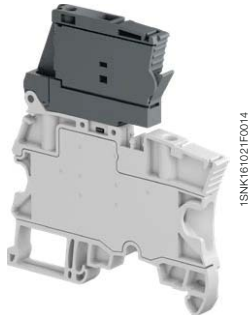

ZS4-SF

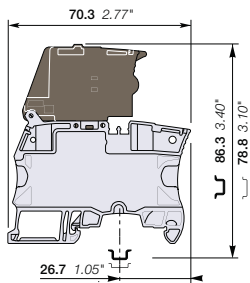

6 mm 0.236 in spacing

Description

- Protect your circuits with 5x20 fuse terminal blocks compliant with IEC 60947-7-3 standard (fuse not supplied with the terminal blocks),
- Simplify the distribution thanks to the two jumper channels aligned with ZS4 or ZS4-R2 feed-through and ZS4-S-R1 disconnect terminal blocks.

Ordering details

Description	Color	Type	Part Number	Pkg qty	Weight (1 pce) g
Fuse	Grey, dark grey	ZS4-SF	1SNK506410R0000	50	18.60

Main technical data

Connecting capacity		IEC	UL - CSA	Mounting instructions	
1 conductor per clamp	Rigid: Solid/Stranded	0.2 ... 4 mm ²	24 ... 10 AWG	Rail	TH 35-7.5, TH 35-15
	Flexible without ferrule	0.22 ... 4 mm ²	24 ... 12 AWG	Wire stripping length	10.5 mm 0.412 in
	Flexible with non insulated ferrule	0.22 ... 4 mm ²	24 ... 12 AWG		
	Flexible with insulated ferrule	0.22 ... 4 mm ²	24 ... 12 AWG		
Gauge		A3-B3		Tool	Flat screwdriver Ø 3.5 mm Ø 0.138 in
2 conductors per clamp	Rigid: Solid/Stranded	0.2 ... 1.5 mm ²	24 ... 16 AWG	Torque	0.6 Nm ± 0.1 5.31 lb.in ± 0.885
	Flexible without ferrule	0.2 ... 1.5 mm ²	24 ... 16 AWG		
Flexible with twin ferrule		0.22 ... 1.5 mm ²	24 ... 16 AWG		
Rated current / Rated cross section		6.3 A / 4 mm ²	10 A / 10 AWG		
Rated voltage		500 V	150 V		
Impulse withstand voltage		6000 V			
Protection		IP20	NEMA 1		

Mount your fuse safely without touching any active part: put the fuse into the hooks of the fuse holder shutter; at the closing of the shutter, the fuse is perfectly in place in the fuse holder.

Separate arrangement		Assembly composed of 1 fuse terminal block in between non fuse terminal blocks	Overload and short-circuit protection	2.5 W
			Exclusive short-circuit protection	4 W
Compound arrangement		Assembly composed of 5 fuse terminal blocks	Overload and short-circuit protection	2.5 W
			Exclusive short-circuit protection	4 W

The connecting capacity data for one Rigid: Solid/Stranded, or one Flexible conductor (when applicable) is a mandatory information required by IEC, UL and CSA standards (Copper conductors). All other data are provided as supplementary information only. For more details, please consult our CB, UL or CSA certificates and technical datasheet available on <http://www.TE.com>



Accessories

Description	Color	Type	Part Number	Pkg qty	Weight (1 pce) g
1 End stops	Dark grey	BAM4	1SNK900001R0000	50	14.00
2 Jumper bars	Orange	JB6-2	1SNK906302R0000	50	1.30
		JB6-3	1SNK906303R0000	50	2.10
		JB6-4	1SNK906304R0000	50	2.90
		JB6-5	1SNK906305R0000	50	3.60
		JB6-10	1SNK906310R0000	20	7.40
		3 Test adapters	Dark grey	TP2	1SNK900203R0000
		TP4	1SNK900205R0000	20	2.40
4 Test connectors	Dark grey	TC5-R1	1SNK900201R0000	10	5.20
5 Spacers	Dark grey	ES-TC6	1SNK900105R0000	10	0.80
6 Terminal block markers	White	MG-CPM 13 41791	1SNB041791R0612	1680	0.27
		MC612	1SNK150000R0000	22	10.00
		MC612PA	1SNK159999R0000	20	11.00
	Universal wire markers holder	Grey	UMH	1SNK900611R0000	10

Complete list of accessories is indicated in the terminal block datasheet including end stops. Some accessories such as jumper bars may modify the terminal block's ratings: Complete information available in the accessories section of the catalog.

Technical data valid for copper conductors only.

ZS4-SF-T screw clamp terminal blocks

For 5 x 20 fuses - with test socket - 6 mm 0.236 in spacing

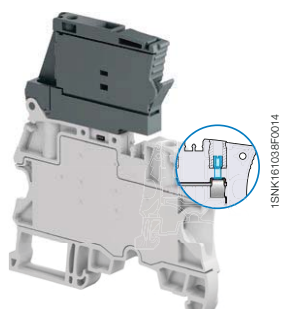

ZS4-SF-T

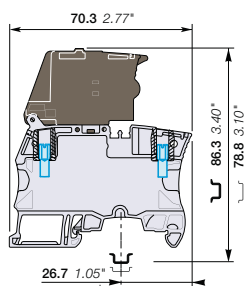

6 mm 0.236 in spacing

Description

- Protect your circuits with 5x20 fuse terminal blocks compliant with IEC 60947-7-3 standard (fuse not supplied with the terminal blocks),
- Simplify the distribution thanks to the two jumper channels aligned with ZS4 or ZS4-R2 feed-through and ZS4-S-R1 disconnect terminal blocks,
- Ease the test with built-in test socket screws.

Ordering details

Description	Color	Type	Part Number	Pkg qty	Weight (1 pce) g
Fuse With 2 test sockets DIA 2 mm 0.079 in	Grey, dark grey	ZS4-SF-T2	1SNK506411R0000	50	18.60

Main technical data

Connecting capacity		IEC	UL - CSA	Mounting instructions	
1 conductor per clamp	Rigid/ Solid/Stranded	0.2 ... 4 mm ²	24 ... 10 AWG	Rail	TH 35-7.5, TH 35-15
	Flexible without ferrule	0.22 ... 4 mm ²		Wire stripping length	10.5 mm 0.412 in
	Flexible with non insulated ferrule	0.22 ... 4 mm ²	24 ... 12 AWG		Tool
	Flexible with insulated ferrule	0.22 ... 4 mm ²	24 ... 12 AWG	Torque	
	Gauge	A3-B3			
2 conductors per clamp	Rigid/ Solid/Stranded	0.2 ... 1.5 mm ²	24 ... 16 AWG		
	Flexible without ferrule	0.2 ... 1.5 mm ²			
	Flexible with twin ferrule	0.22 ... 1.5 mm ²	24 ... 16 AWG		
Rated current / Rated cross section		6.3 A / 4 mm ²	10 A / 10 AWG		
Rated voltage		500 V	150 V		
Impulse withstand voltage		6000 V			
Protection		IP20	NEMA 1		

Mount your fuse safely without touching any active part: put the fuse into the hooks of the fuse holder shutter; at the closing of the shutter, the fuse is perfectly in place in the fuse holder.

Separate arrangement		Assembly composed of 1 fuse terminal block in between non fuse terminal blocks	Overload and short-circuit protection	2.5 W
			Exclusive short-circuit protection	4 W
Compound arrangement		Assembly composed of 5 fuse terminal blocks	Overload and short-circuit protection	2.5 W
			Exclusive short-circuit protection	4 W

The connecting capacity data for one Rigid/ Solid/Stranded, or one Flexible conductor (when applicable) is a mandatory information required by IEC, UL and CSA standards (Copper conductors). All other data are provided as supplementary information only. For more details, please consult our CB, UL or CSA certificates and technical datasheet available on <http://www.TE.com>

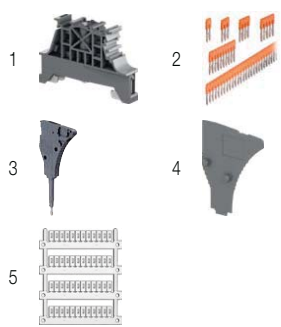
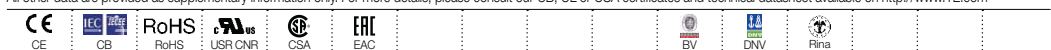

Accessories

Description	Color	Type	Part Number	Pkg qty	Weight (1 pce) g	
1 End stops	Dark grey	BAM4	1SNK900001R0000	50	14.00	
2 Jumper bars	Orange	2 poles	JB6-2	1SNK906302R0000	50	1.30
		3 poles	JB6-3	1SNK906303R0000	50	2.10
		4 poles	JB6-4	1SNK906304R0000	50	2.90
		5 poles	JB6-5	1SNK906305R0000	50	3.60
		10 poles	JB6-10	1SNK906310R0000	20	7.40
3 Test connectors	Dark grey	TC5-R1	1SNK900201R0000	10	5.20	
4 Spacers	Dark grey	ES-TC6	1SNK900105R0000	10	0.80	
5 Terminal block markers	White	Blank marker	MG-CPM 13 41791	1SNB041791R0612	1680	0.27
		Blank card	MC612	1SNK150000R0000	22	10.00
			MC612PA	1SNK159999R0000	20	11.00
	Universal wire markers holder	Grey	UMH	1SNK900611R0000	10	0.20

Complete list of accessories is indicated in the terminal block datasheet including end stops.

Some accessories such as jumper bars may modify the terminal block's ratings: Complete information available in the accessories section of the catalog.

Technical data valid for copper conductors only.

ZS4-SF-R screw clamp terminal blocks

For 5 x 20 fuses - with blown fuse indicator - 6 mm 0.236 in spacing

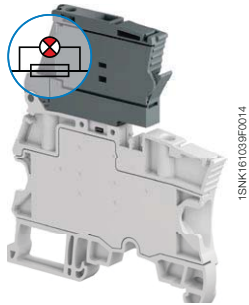

ZS4-SF-R

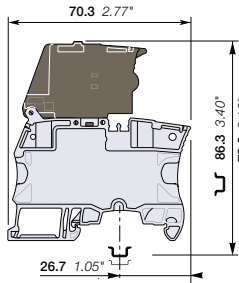

6 mm 0.236 in spacing

Description

- Protect your circuits with 5x20 fuse terminal blocks compliant with IEC 60947-7-3 standard (fuse not supplied with the terminal blocks),
- Simplify the distribution thanks to the two jumper channels aligned with ZS4 or ZS4-R2 feed-through and ZS4-S-R1 disconnect terminal blocks,
- Quickly identify the defective circuit thanks to the blown fuse indicator (with leakage current < 0.5 mA).

Ordering details

Description	Color	Type	Part Number	Pkg qty	Weight (1 pce) g
Fuse With blown fuse indicator 115 ... 250 V AC / DC	Grey, dark grey	ZS4-SF-R3	1SNK506415R0000	50	18.60
With blown fuse indicator 24 ... 110 V AC / DC		ZS4-SF-R1	1SNK506412R0000	50	18.60

Main technical data

Connecting capacity		IEC	UL - CSA	Mounting instructions	
1 conductor per clamp	Rigid: Solid/Stranded	0.2 ... 4 mm ²	24 ... 10 AWG	Rail	TH 35-7.5, TH 35-15
	Flexible without ferrule	0.22 ... 4 mm ²		Wire stripping length	10.5 mm 0.412 in
	Flexible with non insulated ferrule	0.22 ... 4 mm ²	24 ... 12 AWG	Tool	Flat screwdriver Ø 3.5 mm Ø 0.138 in
	Flexible with insulated ferrule	0.22 ... 4 mm ²	24 ... 12 AWG		
Gauge		A3-B3		Torque	0.6 Nm ± 0.1 5.31 lb.in ± 0.885
2 conductors per clamp	Rigid: Solid/Stranded	0.2 ... 1.5 mm ²	24 ... 16 AWG		
	Flexible without ferrule	0.2 ... 1.5 mm ²			
	Flexible with twin ferrule	0.22 ... 1.5 mm ²	24 ... 16 AWG		
Rated current / Rated cross section		6.3 A / 4 mm ²	10 A / 10 AWG		
Rated voltage		500 V	150 V		
Impulse withstand voltage		6000 V			
Protection		IP20	NEMA 1		

Mount your fuse safely without touching any active part: put the fuse into the hooks of the fuse holder shutter; at the closing of the shutter, the fuse is perfectly in place in the fuse holder.

Separate arrangement		Assembly composed of 1 fuse terminal block in between non fuse terminal blocks	Overload and short-circuit protection	2.5 W
			Exclusive short-circuit protection	4 W
Compound arrangement		Assembly composed of 5 fuse terminal blocks	Overload and short-circuit protection	2.5 W
			Exclusive short-circuit protection	4 W

The connecting capacity data for one Rigid: Solid/Stranded, or one Flexible conductor (when applicable) is a mandatory information required by IEC, UL and CSA standards (Copper conductors). All other data are provided as supplementary information only. For more details, please consult our CB, UL or CSA certificates and technical datasheet available on <http://www.TE.com>

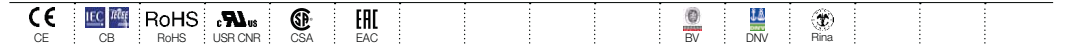

Accessories

Description	Color	Type	Part Number	Pkg qty	Weight (1 pce) g	
1 End stops	Dark grey	BAM4	1SNK900001R0000	50	14.00	
2 Jumper bars	Orange	2 poles	JB6-2	1SNK906302R0000	50	1.30
		3 poles	JB6-3	1SNK906303R0000	50	2.10
		4 poles	JB6-4	1SNK906304R0000	50	2.90
		5 poles	JB6-5	1SNK906305R0000	50	3.60
		10 poles	JB6-10	1SNK906310R0000	20	7.40
3 Test adapters	Dark grey	For test plugs DIA 2 mm 0.079 in	TP2	1SNK900203R0000	20	1.70
		For test plugs DIA 4 mm 0.157 in	TP4	1SNK900205R0000	20	2.40
4 Test connectors	Dark grey	TC5-R1	1SNK900201R0000	10	5.20	
5 Spacers	Dark grey	ES-TC6	1SNK900105R0000	10	0.80	
6 Terminal block markers	White	Blank marker	MG-CPM 13 41791	1SNB041791R0612	1680	0.27
		Blank card	MC612	1SNK150000R0000	22	10.00
			MC612PA	1SNK159999R0000	20	11.00
	Universal wire markers holder	Grey	UMH	1SNK900611R0000	10	0.20

Complete list of accessories is indicated in the terminal block datasheet including end stops. Some accessories such as jumper bars may modify the terminal block's ratings: Complete information available in the accessories section of the catalog.

Technical data valid for copper conductors only.

ZS4-SF-R screw clamp terminal blocks

For 5 x 20 fuses - with blown fuse indicator and test sockets - 6 mm 0.236 in spacing

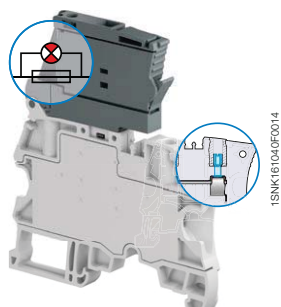

ZS4-SF-R

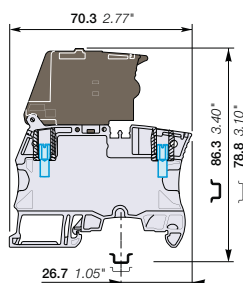

6 mm 0.236 in spacing

Description

- Protect your circuits with 5x20 fuse terminal blocks compliant with IEC 60947-7-3 standard (fuse not supplied with the terminal blocks),
- Simplify the distribution thanks to the two jumper channels aligned with ZS4 or ZS4-R2 feed-through and ZS4-S-R1 disconnect terminal blocks,
- Ease the test with built-in test socket screws,
- Quickly identify the defective circuit thanks to the blown fuse indicator (with leakage current < 0.5 mA).

Ordering details

Description	Color	Type	Part Number	Pkg qty	Weight (1 pce) g
Fuse With blown fuse indicator 115 ... 250 V AC / DC and 2 test sockets DIA 2 mm 0.079 in	Grey, dark grey	ZS4-SF-R4	1SNK506416R0000	50	18.60
With blown fuse indicator 24 ... 110 V AC / DC and 2 test sockets DIA 2 mm 0.079 in		ZS4-SF-R2	1SNK506413R0000	50	18.60

Main technical data

Connecting capacity	IEC	UL - CSA	Rail	Wire stripping length	TH 35-7.5, TH 35-15
1 conductor per clamp	Rigid: Solid/Stranded	0.2 ... 4 mm²	24 ... 10 AWG		
	Flexible without ferrule	0.22 ... 4 mm²			10.5 mm 0.412 in
	Flexible with non insulated ferrule	0.22 ... 4 mm²	24 ... 12 AWG		
	Flexible with insulated ferrule	0.22 ... 4 mm²	24 ... 12 AWG		
Gauge	A3-B3				
2 conductors per clamp	Rigid: Solid/Stranded	0.2 ... 1.5 mm²	24 ... 16 AWG	Tool	Flat screwdriver Ø 3.5 mm Ø 0.138 in
	Flexible without ferrule	0.2 ... 1.5 mm²			
	Flexible with twin ferrule	0.22 ... 1.5 mm²	24 ... 16 AWG		
Rated current / Rated cross section	6.3 A / 4 mm²	10 A / 10 AWG			
			Torque		0.6 Nm ± 0.1 5.31 lb.in ± 0.885
Rated voltage	500 V	150 V			
Impulse withstand voltage	6000 V				
Protection	IP20	NEMA 1			

Mount your fuse safely without touching any active part: put the fuse into the hooks of the fuse holder shutter; at the closing of the shutter, the fuse is perfectly in place in the fuse holder.

Separate arrangement	Compound arrangement	Protection	Power
Assembly composed of 1 fuse terminal block in between non fuse terminal blocks	Assembly composed of 5 fuse terminal blocks	Overload and short-circuit protection	2.5 W
		Exclusive short-circuit protection	4 W
		Overload and short-circuit protection	2.5 W
		Exclusive short-circuit protection	4 W

The connecting capacity data for one Rigid: Solid/Stranded, or one Flexible conductor (when applicable) is a mandatory information required by IEC, UL and CSA standards (Copper conductors). All other data are provided as supplementary information only. For more details, please consult our CB, UL or CSA certificates and technical datasheet available on <http://www.TE.com>

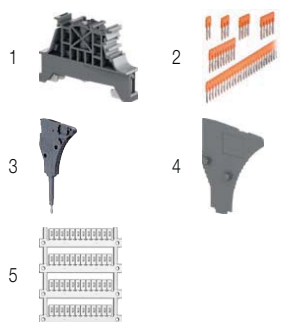
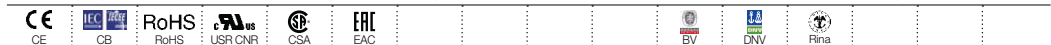

Accessories

Description	Color	Type	Part Number	Pkg qty	Weight (1 pce) g	
1 End stops	Dark grey	BAM4	1SNK900001R0000	50	14.00	
2 Jumper bars	Orange	2 poles	JB6-2	1SNK906302R0000	50	1.30
		3 poles	JB6-3	1SNK906303R0000	50	2.10
		4 poles	JB6-4	1SNK906304R0000	50	2.90
		5 poles	JB6-5	1SNK906305R0000	50	3.60
		10 poles	JB6-10	1SNK906310R0000	20	7.40
		3 Test connectors	Dark grey	TC5-R1	1SNK900201R0000	10
4 Spacers	Dark grey	ES-TC6	1SNK900105R0000	10	0.80	
5 Terminal block markers	White	Blank marker	MG-CPM 13 41791	1SNB041791R0612	1680	0.27
		Blank card	MC612	1SNK150000R0000	22	10.00
		Universal wire markers holder	MC612PA	1SNK159999R0000	20	11.00
	Grey	UMH	1SNK900611R0000	10	0.20	

Complete list of accessories is indicated in the terminal block datasheet including end stops. Some accessories such as jumper bars may modify the terminal block's ratings: Complete information available in the accessories section of the catalog.

Technical data valid for copper conductors only.

ZS4-R2 screw clamp terminal blocks

Feed-through - 6 mm 0.236 in spacing

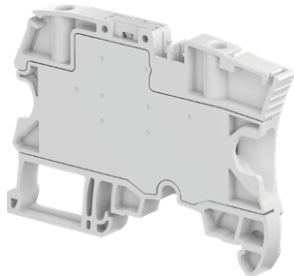

ZS4-R2

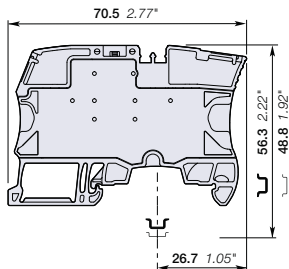

6 mm 0.236 in spacing

Description

- Simplify the distribution of circuits in marshalling cabinets thanks to our feed-through terminal blocks with the same profile as ZS4-SF fuse, ZS4-S-R1 disconnect and ZS4-PE-R2 ground terminal blocks: aligned conductor entries, jumper channels and marking in just 6 mm 0.236 in spacing,
- No end section needed: closed block.

Ordering details

Description	Color	Type	Part Number	Pkg qty	Weight (1 pce) g
Feed-through Profile aligned with ZS4-SF and ZS4-S-R1	Grey <input type="checkbox"/>	ZS4-R2	1SNK506013R0000	50	12.40

Main technical data

Connecting capacity		IEC	UL - CSA	Mounting instructions	
1 conductor per clamp	Rigid: Solid/Stranded	0.2 ... 4 mm ²	24 ... 10 AWG	Rail	TH 35-7.5, TH 35-15
	Flexible without ferrule	0.22 ... 4 mm ²		Wire stripping length	10.5 mm 0.413 in
	Flexible with non insulated ferrule	0.22 ... 4 mm ²	24 ... 12 AWG	Tool	Flat screwdriver Ø 3.5 mm Ø 0.138 in
	Flexible with insulated ferrule	0.22 ... 4 mm ²	24 ... 12 AWG		
Gauge A3-B3				Torque	0.6 Nm ± 0.1 5.31 lb.in ± 0.885
2 conductors per clamp	Rigid: Solid/Stranded	0.2 ... 1.5 mm ²	24 ... 16 AWG		
	Flexible without ferrule	0.2 ... 1.5 mm ²	24 ... 16 AWG		
	Flexible with twin ferrule	0.22 ... 1.5 mm ²	24 ... 16 AWG		
Rated current / Rated cross section		32 A / 4 mm ²	30 A / 10 AWG		
Rated short-time withstand current (1s)		480 A			
Rated voltage		800 V	300 V		
Impulse withstand voltage		8000 V			
Protection		IP20	NEMA 1		

The connecting capacity data for one Rigid: Solid/Stranded, or one Flexible conductor (when applicable) is a mandatory information required by IEC, UL and CSA standards (Copper conductors). All other data are provided as supplementary information only. For more details, please consult our CB, UL or CSA certificates and technical datasheet available on <http://www.TE.com>



Accessories

Description	Color	Type	Part Number	Pkg qty	Weight (1 pce) g
1 End stops 10 mm 0.394 in	Dark grey <input type="checkbox"/>	BAM4	1SNK900001R0000	50	14.00
2 Jumper bars 2 poles 41 A (IEC)	Orange <input type="checkbox"/>	JB6-2	1SNK906302R0000	50	1.30
		JB6-3	1SNK906303R0000	50	2.10
		JB6-4	1SNK906304R0000	50	2.90
		JB6-5	1SNK906305R0000	50	3.60
		JB6-10	1SNK906310R0000	20	7.40
3 Cross spacing jumpers 3 poles 32 A (IEC)	Orange <input type="checkbox"/>	JB85-3	1SNK900603R0000	10	2.80
4 Test adapters For test plugs DIA 2 mm 0.079 in	Dark grey <input type="checkbox"/>	TP2	1SNK900203R0000	20	1.70
		TP4	1SNK900205R0000	20	2.40
5 Test connectors End module, 5.2 mm 0.205 in	Dark grey <input type="checkbox"/>	TC5-R1	1SNK900201R0000	10	5.20
6 Spacers 0.8 mm 0.031 in	Dark grey <input type="checkbox"/>	ES-TC6	1SNK900105R0000	10	0.80
7 Terminal block markers Blank marker	White <input type="checkbox"/>	MG-CPM 13 41791	1SNB041791R0612	1680	0.27
		MC612	1SNK150000R0000	22	10.00
		MC612PA	1SNK159999R0000	20	11.00
Universal wire markers holder	Grey <input type="checkbox"/>	UMH	1SNK900611R0000	10	0.20

Complete list of accessories is indicated in the terminal block datasheet including end stops. Some accessories such as jumper bars may modify the terminal block's ratings: Complete information available in the accessories section of the catalog.

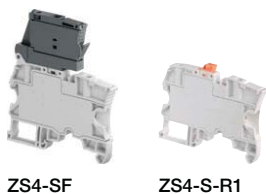
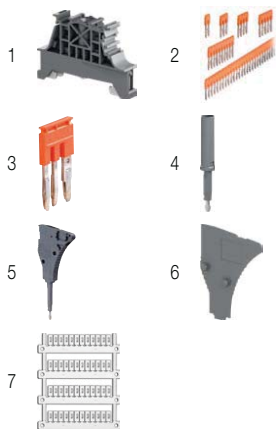

ZS4-SF

ZS4-S-R1

Screw clamp terminal blocks

Description	Color	Type	Part Number	Pkg qty	Weight (1 pce) g
Fuse Profile aligned with ZS4-R2 and ZS4-PE-R2	Grey, dark grey <input type="checkbox"/>	ZS4-SF	1SNK506410R0000	50	18.60
Disconnect Profile aligned with ZS4-R2 and ZS4-PE-R2	Grey <input type="checkbox"/>	ZS4-S-R1	1SNK506310R0000	50	13.20

Technical data valid for copper conductors only.

ZS4-PE-R2 screw clamp terminal blocks

Ground - 6 mm 0.236 in spacing



ZS4-PE-R2

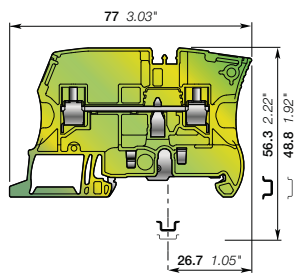

6 mm 0.236 in spacing

Description

Simplify the shielding connection of your analog circuits in marshalling cabinets thanks to our ground terminal blocks with the same profile as ZS4-SF fuse, ZS4-S-R1 disconnect and ZS4-R2 feed-through terminal blocks.

Ordering details

Description	Color	Type	Part Number	Pkg qty	Weight (1 pce)
Ground Screwless rail connection	Green-yellow	ZS4-PE-R2	1SNK506153R0000	25	15.30 g

Main technical data

Connecting capacity	IEC	UL - CSA	Mounting instructions
1 conductor per clamp			
Rigid: Solid/Stranded	0.2 ... 4 mm²	24 ... 10 AWG	Rail TH 35-7.5, TH 35-15
Flexible without ferrule	0.22 ... 4 mm²	24 ... 12 AWG	Wire stripping length 10.5 mm 0.413 in
Flexible with non insulated ferrule	0.22 ... 4 mm²	24 ... 12 AWG	Tool Flat screwdriver Ø 3.5 mm Ø 0.138 in
Flexible with insulated ferrule	0.22 ... 4 mm²	24 ... 12 AWG	
Gauge	A3-B3		Torque 0.6 Nm ± 0.1 5.31 lb.in ± 0.885
Rated cross section	4 mm²	10 AWG	
Rated short-time withstand current (1s)	480 A	396 A	
Protection	IP20	NEMA 1	

The connecting capacity data for one Rigid: Solid/Stranded, or one Flexible conductor (when applicable) is a mandatory information required by IEC, UL and CSA standards (Copper conductors). All other data are provided as supplementary information only. For more details, please consult our CB, UL or CSA certificates and technical datasheet available on <http://www.TE.com>

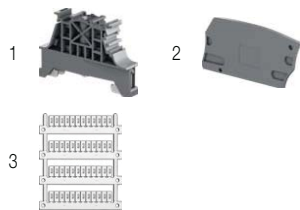

Accessories

Description	Color	Type	Part Number	Pkg qty	Weight (1 pce)
1 End stops	Dark grey	BAM4	1SNK900001R0000	50	14.00 g
2 End sections	Dark grey	ES6-4S	1SNK505911R0000	20	3.10 g
3 Terminal block markers	White	MG-CPM 13 41791	1SNB041791R0612	1680	0.27 g
		MC612PA	1SNK150000R0000	22	10.00 g
		MC612PA	1SNK159999R0000	20	11.00 g
Universal wire markers holder	Grey	UMH	1SNK900611R0000	10	0.20 g

Complete list of accessories is indicated in the terminal block datasheet including end stops. Some accessories such as jumper bars may modify the terminal block's ratings: Complete information available in the accessories section of the catalog.



ZS4-SF

ZS4-S-R1

Screw clamp terminal blocks

Description	Color	Type	Part Number	Pkg qty	Weight (1 pce)
Fuse	Grey, dark grey	ZS4-SF	1SNK506410R0000	50	18.60 g
Disconnect	Grey	ZS4-S-R1	1SNK506310R0000	50	13.20 g

Technical data valid for copper conductors only.

ZS4-S-R2 screw clamp terminal blocks

Disconnect with lever - 6 mm 0.236 in spacing

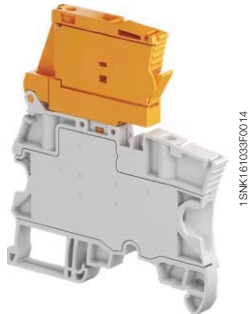

ZS4-S-R2

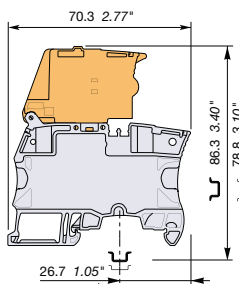

6 mm 0.236 in spacing

Description

Simplify the disconnect operations for the disconnect terminal blocks installed next to fuse terminal blocks ZS4-SF:
 - With the same profile as ZS4-SF, the ZS4-S-R2 disconnect lever is easily operated by hand and the wiring of the alternated disconnect and fuse circuits is easier.

Ordering details

Description	Color	Type	Part Number	Pkg qty	Weight (1 pce) g
Disconnect Profile aligned with ZS4-SF	Grey, orange	ZS4-S-R2	1SNK506414R0000	50	21.6

Main technical data

Connecting capacity		IEC	UL - CSA	Mounting instructions	
1 conductor per clamp	Rigid: Solid/Stranded	0.2 ... 4 mm ²	24 ... 10 AWG	Rail	 TH 35-7.5, TH 35-15 10.5 mm 0.412 in
	Flexible without ferrule	0.22 ... 4 mm ²			
	Flexible with non insulated ferrule	0.22 ... 4 mm ²	24 ... 12 AWG	Wire stripping length	 10.5 mm 0.412 in
	Flexible with insulated ferrule	0.22 ... 4 mm ²	24 ... 12 AWG		
Gauge		A3-B3		Tool	 Flat screwdriver Ø 3.5 mm Ø 0.138 in
2 conductors per clamp	Rigid: Solid/Stranded	0.2 ... 1.5 mm ²	24 ... 16 AWG		
	Flexible without ferrule	0.2 ... 1.5 mm ²			
	Flexible with twin ferrule	0.22 ... 1.5 mm ²	24 ... 16 AWG		
Rated current / Rated cross section		18 A / 2.5 mm ²	13 A / 10 AWG	Torque	 0.6 Nm ± 0.1 5.31 lb.in ± 0.885
Maximum current / Maximum cross section		18 A / 4 mm ²			
Rated short-time withstand current (1s)		300 A			
Rated voltage		400 V	150 V		
Impulse withstand voltage		6000 V			
Protection		IP20	NEMA 1		

Recommendation for best usage: in horizontal assemblies, disconnect terminal blocks should be mounted with fixed foot on top (power side) so that the disconnect lever does not partially close through gravity. Furthermore, as specified per IEC 60947-7-1, disconnect terminal blocks are intended to be used for temporary disconnection at zero potential and at no load.

The connecting capacity data for one Rigid: Solid/Stranded, or one Flexible conductor (when applicable) is a mandatory information required by IEC, UL and CSA standards (Copper conductors). All other data are provided as supplementary information only. For more details, please consult our CB, UL or CSA certificates and technical datasheet available on <http://www.TE.com>



Accessories

Description	Color	Type	Part Number	Pkg qty	Weight (1 pce) g	
1 End stops	Dark grey	BAM4	1SNK900001R0000	50	14.00	
2 Jumper bars	Orange	2 poles	JB6-2	1SNK906302R0000	50	1.30
		3 poles	JB6-3	1SNK906303R0000	50	2.10
		4 poles	JB6-4	1SNK906304R0000	50	2.90
		5 poles	JB6-5	1SNK906305R0000	50	3.60
		10 poles	JB6-10	1SNK906310R0000	20	7.40
3 Test adapters	Dark grey	For test plugs DIA 2 mm 0.079 in	TP2	1SNK900203R0000	20	1.70
		For test plugs DIA 4 mm 0.157 in	TP4	1SNK900205R0000	20	2.40
4 Test connectors	Dark grey	TC5-R1	1SNK900201R0000	10	5.20	
5 Spacers	Dark grey	ES-TC6	1SNK900105R0000	10	0.80	
6 Terminal block markers	White	Blank marker	MG-CPM 13 41791	1SNB041791R0612	1680	0.27
		Blank card	MC612	1SNK150000R0000	22	10.00
		Universal wire markers holder	MC612PA	1SNK159999R0000	20	11.00
	Grey	UMH	1SNK900611R0000	10	0.20	

Complete list of accessories is indicated in the terminal block datasheet including end stops. Some accessories such as jumper bars may modify the terminal block's ratings: Complete information available in the accessories section of the catalog.

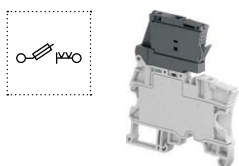
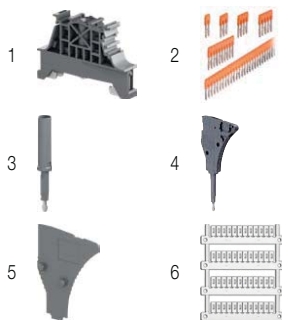

Fuse screw clamp terminal blocks

Description	Color	Type	Part Number	Pkg qty	Weight (1 pce) g
Fuse	Grey, dark grey	ZS4-SF	1SNK506410R0000	50	18.60

Technical data valid for copper conductors only.

ZS10-SF screw clamp terminal blocks

For 6.3x32 fuses - 8 mm 0.315 in spacing



ZS10-SF

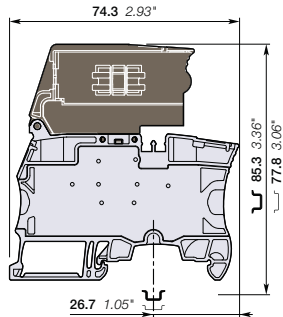

8 mm 0.315 in spacing

Description

- Protect your circuits with 6.3x32 (1/4 x 1/4 in) fuse terminal blocks compliant with IEC 60947-7-3 standard (fuse not supplied with the terminal blocks),
- Simplify the distribution thanks to the two jumper channels.

Ordering details

Description	Color	Type	Part Number	Pkg qty	Weight (1 pce) g
Fuse Closed block	Grey, dark grey	ZS10-SF	1SNK508418R0000	50	28.50

Main technical data

Connecting capacity		IEC	UL - CSA	Mounting instructions	
1 conductor per clamp	Rigid: Solid/Stranded	0.5 ... 10 mm ²	24 ... 6 AWG	Rail	TH 35-7.5, TH 35-15
	Flexible without ferrule	0.5 ... 10 mm ²		Wire stripping length	13 mm 0.512 in
	Flexible with non insulated ferrule	0.5 ... 10 mm ²	24 ... 8 AWG		
	Flexible with insulated ferrule	0.5 ... 6 mm ²	24 ... 10 AWG		
Gauge		A5-B5			
2 conductors per clamp	Rigid: Solid/Stranded	0.5 ... 4 mm ²	20 ... 12 AWG	Tool	Flat screwdriver Ø 4 mm Ø 0.157 in
	Flexible without ferrule	0.5 ... 4 mm ²			
	Flexible with twin ferrule	0.5 ... 4 mm ²	20 ... 12 AWG		
Rated current / Rated cross section		10 A / 10 mm ²	22 A / 6 AWG	Torque	1.3 Nm ± 0.3 11.5 lb.in ± 2.65
Rated voltage		630 V	600 V		
Impulse withstand voltage		6000 V			
Protection		IP20	NEMA 1		

Mount your fuse safely without touching any active part: put the fuse into the hooks of the fuse holder shutter; at the closing of the shutter, the fuse is perfectly in place in the fuse holder.

Separate arrangement		Assembly composed of 1 fuse terminal block in between non fuse terminal blocks	Overload and short-circuit protection	4 W
			Exclusive short-circuit protection	4 W
Compound arrangement		Assembly composed of 5 fuse terminal blocks	Overload and short-circuit protection	2.5 W
			Exclusive short-circuit protection	2.5 W

The connecting capacity data for one Rigid: Solid/Stranded, or one Flexible conductor (when applicable) is a mandatory information required by IEC, UL and CSA standards (Copper conductors). All other data are provided as supplementary information only. For more details, please consult our CB, UL or CSA certificates and technical datasheet available on <http://www.TE.com>

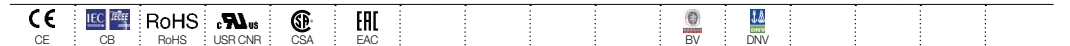

Accessories

Description	Color	Type	Part Number	Pkg qty	Weight (1 pce) g
1 End stops	Dark grey	BAM4	1SNK900001R0000	50	14.00
2 Jumper bars	Orange	JB8-2	1SNK908302R0000	50	2.70
		JB8-3	1SNK908303R0000	50	4.10
		JB8-4	1SNK908304R0000	50	5.60
		JB8-5	1SNK908305R0000	40	7.00
		JB8-10	1SNK908310R0000	20	14.20
3 Test adapters	Dark grey	TP2	1SNK900203R0000	20	1.70
		TP4	1SNK900205R0000	20	2.40
4 Test connectors	Dark grey	TC5	1SNK900200R0000	10	5.20
		TC5-R1	1SNK900201R0000	10	5.20
5 Spacers	Dark grey	ES-TC8	1SNK900104R0000	10	1.40
		MG-CPM 13 41791	1SNK041791R0612	1680	0.27
6 Terminal block markers	White	MC812	1SNK160000R0000	22	10.00
		MC812PA	1SNK169999R0000	20	14.00
		Universal wire markers holder	UMH	1SNK900611R0000	10

Complete list of accessories is indicated in the terminal block datasheet including end stops. Some accessories such as jumper bars may modify the terminal block's ratings: Complete information available in the accessories section of the catalog.

Technical data valid for copper conductors only.

ZS10-SF-R screw clamp terminal blocks

For 6.3x32 fuses - with blown fuse indicator - 8 mm 0.315 in spacing

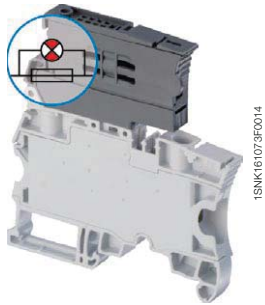

ZS10-SF-R

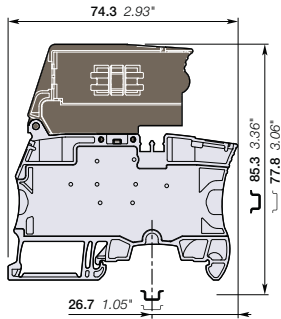

8 mm 0.315 in spacing

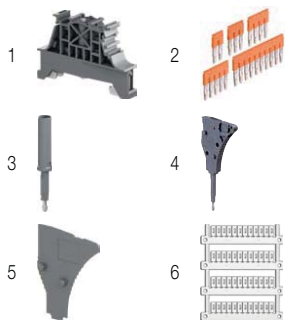

Description

- Protect your circuits with 6.3x32 (1/4 x 1 1/4 in) fuse terminal blocks compliant with IEC 60947-7-3 standard (fuse not supplied with the terminal blocks),
- Quickly identify the defective circuit thanks to the blown fuse indicator (with leakage current < 0.5 mA).

Ordering details

Description	Color	Type	Part Number	Pkg qty	Weight (1 pce) g
Fuse With blown fuse indicator 115 ... 250 V AC / DC	Grey, dark grey	ZS10-SF-R3	1SNK508422R0000	50	30.50
With blown fuse indicator 24 ... 110 V AC / DC		ZS10-SF-R1	1SNK508421R0000	50	30.50

Main technical data

Connecting capacity	IEC	UL - CSA	Mounting instructions	
1 conductor per clamp	Rigid: Solid/Stranded	0.5 ... 10 mm ²	24 ... 6 AWG	Wire stripping length
	Flexible without ferrule	0.5 ... 10 mm ²		
	Flexible with non insulated ferrule	0.5 ... 10 mm ²	24 ... 8 AWG	Tool
	Flexible with insulated ferrule	0.5 ... 6 mm ²	24 ... 10 AWG	
Gauge		A5-B5	Flat screwdriver Ø 4 mm Ø 0.157 in	
2 conductors per clamp	Rigid: Solid/Stranded	0.5 ... 4 mm ²	20 ... 12 AWG	Torque
	Flexible without ferrule	0.5 ... 4 mm ²		
	Flexible with twin ferrule	0.5 ... 4 mm ²	20 ... 12 AWG	
Rated current / Rated cross section		10 A / 10 mm ²	22 A / 6 AWG	1.3 Nm ± 0.3 11.5 lb.in ± 2.65
Rated voltage		630 V	600 V	
Impulse withstand voltage		6000 V		
Protection		IP20	NEMA 1	

Mount your fuse safely without touching any active part: put the fuse into the hooks of the fuse holder shutter; at the closing of the shutter, the fuse is perfectly in place in the fuse holder.

Separate arrangement	Assembly composed of 1 fuse terminal block in between non fuse terminal blocks	Overload and short-circuit protection	4 W
		Exclusive short-circuit protection	4 W
Compound arrangement	Assembly composed of 5 fuse terminal blocks	Overload and short-circuit protection	2.5 W
		Exclusive short-circuit protection	2.5 W

The connecting capacity data for one Rigid: Solid/Stranded, or one Flexible conductor (when applicable) is a mandatory information required by IEC, UL and CSA standards (Copper conductors). All other data are provided as supplementary information only. For more details, please consult our CB, UL or CSA certificates and technical datasheet available on <http://www.TE.com>

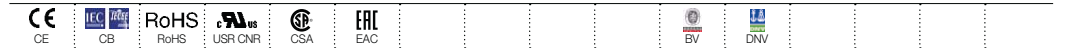

Accessories

Description	Color	Type	Part Number	Pkg qty	Weight (1 pce) g	
1 End stops	Dark grey	BAM4	1SNK900001R0000	50	14.00	
2 Jumper bars	Orange	2 poles	JB8-2	1SNK908302R0000	50	2.70
		3 poles	JB8-3	1SNK908303R0000	50	4.10
		4 poles	JB8-4	1SNK908304R0000	50	5.60
		5 poles	JB8-5	1SNK908305R0000	40	7.00
		10 poles	JB8-10	1SNK908310R0000	20	14.20
		3 Test adapters	Dark grey	TP2	1SNK900203R0000	20
4 Test connectors	Dark grey	For test plugs DIA 2 mm 0.079 in	TP4	1SNK900205R0000	20	2.40
		For test plugs DIA 4 mm 0.157 in	TC5	1SNK900200R0000	10	5.20
		End module, 5.2 mm 0.205 in	TC5-R1	1SNK900201R0000	10	5.20
5 Spacers	Dark grey	ES-TC8	1SNK900104R0000	10	1.40	
6 Terminal block markers	White	Blank marker	MG-CPM 13 41791	1SNB041791R0612	1680	0.27
		Blank card	MC812	1SNK160000R0000	22	10.00
			MC812PA	1SNK169999R0000	20	14.00
		Universal wire markers holder	Grey	UMH	1SNK900611R0000	10

Complete list of accessories is indicated in the terminal block datasheet including end stops. Some accessories such as jumper bars may modify the terminal block's ratings: Complete information available in the accessories section of the catalog.

Technical data valid for copper conductors only.

ZS10-S-R2 screw clamp terminal blocks

Disconnect with lever - 8 mm 0.315 in spacing

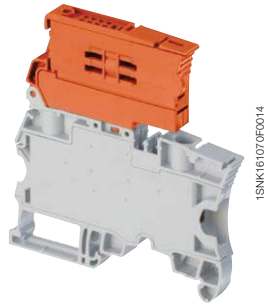

ZS10-S-R2

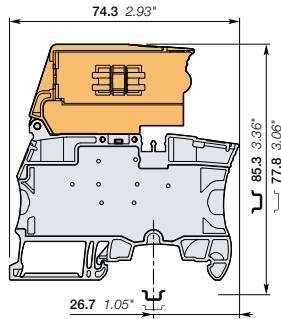

8 mm 0.315 in spacing

Description

Simplify the disconnect operations for the disconnect terminal blocks installed next to fuse terminal blocks ZS10-SF:
 – With the same profile as ZS10-SF, the ZS10-S-R2 disconnect lever is easily operated by hand and the wiring of the alternated disconnect and fuse circuits is easier.

Ordering details

Description	Color	Type	Part Number	Pkg qty	Weight (1 pce) g
Disconnect Profile aligned with ZS10-SF	Grey, orange	ZS10-S-R2	1SNK508417R0000	50	35.90

Main technical data

Connecting capacity	IEC	UL - CSA	Mounting instructions
1 conductor per clamp	Rigid: Solid/Stranded Flexible without ferrule Flexible with non insulated ferrule Flexible with insulated ferrule Gauge	0.5 ... 10 mm ² 0.5 ... 10 mm ² 0.5 ... 10 mm ² 0.5 ... 6 mm ² A5-B5	24 ... 6 AWG 24 ... 8 AWG 24 ... 10 AWG
2 conductors per clamp	Rigid: Solid/Stranded Flexible without ferrule Flexible with twin ferrule	0.5 ... 4 mm ² 0.5 ... 4 mm ² 0.5 ... 4 mm ²	20 ... 12 AWG 20 ... 12 AWG
Rated current / Rated cross section		10 A / 4 mm ²	22 A / 25 AWG
Maximum current / Maximum cross section		25 A / 10 mm ²	
Rated short-time withstand current (1s)		480 A	
Rated voltage		630 V	600 V
Impulse withstand voltage		6000 V	
Protection		IP20	NEMA 1

Recommendation for best usage: in horizontal assemblies, disconnect terminal blocks should be mounted with fixed foot on top (power side) so that the disconnect lever does not partially close through gravity. Furthermore, as specified per IEC 60947-7-1, disconnect terminal blocks are intended to be used for temporary disconnection at zero potential and at no load.

The connecting capacity data for one Rigid: Solid/Stranded, or one Flexible conductor (when applicable) is a mandatory information required by IEC, UL and CSA standards (Copper conductors). All other data are provided as supplementary information only. For more details, please consult our CB, UL or CSA certificates and technical datasheet available on <http://www.TE.com>

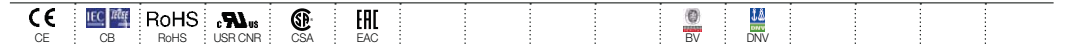

Accessories

Description	Color	Type	Part Number	Pkg qty	Weight (1 pce) g
1 End stops	Dark grey	BAM4	1SNK900001R0000	50	14.00
2 Jumper bars	Orange	JB8-2 JB8-3 JB8-4 JB8-5 JB8-10	1SNK908302R0000 1SNK908303R0000 1SNK908304R0000 1SNK908305R0000 1SNK908310R0000	50 50 50 40 20	14.00 4.10 5.60 7.00 14.20
3 Test adapters	Dark grey	TP2 TP4	1SNK900203R0000 1SNK900205R0000	20 20	1.70 2.40
4 Test connectors	Dark grey	TC5 TC5-R1	1SNK900200R0000 1SNK900201R0000	10 10	5.20 5.20
5 Spacers	Dark grey	ES-TC8	1SNK900104R0000	10	1.40
6 Terminal block markers	White	MG-CPM 13 41791 MC812 MC812PA	1SNB041791R0612 1SNK160000R0000 1SNK169999R0000	1680 22 20	0.27 10.00 14.00
	Grey	UMH	1SNK900611R0000	10	0.20

Complete list of accessories is indicated in the terminal block datasheet including end stops. Some accessories such as jumper bars may modify the terminal block's ratings: Complete information available in the accessories section of the catalog.

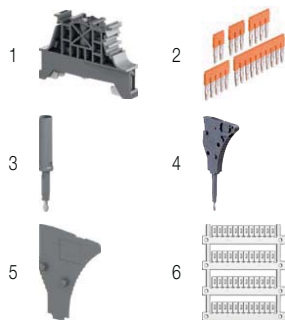

Fuse screw clamp terminal blocks

Description	Color	Type	Part Number	Pkg qty	Weight (1 pce) g
Fuse Closed block	Grey, dark grey	ZS10-SF	1SNK508418R0000	50	28.50

Technical data valid for copper conductors only.



3

1SNK161055S0201

ZS4-D2 screw clamp terminal blocks

Double deck with 2 feed-through circuits - 5.2 mm 0.205 in spacing



ZS4-D2

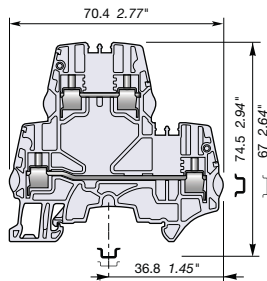

5.2 mm 0.205 in spacing

Description

- Save space with double deck terminal blocks: 2 independent circuits connected in just 5.2 mm 0.205 in spacing,
- Customize yourself the ZS4-D2 by soldering electronic components (up to 8.8 mm x 3.2 mm 0.346 x 0.125 in) in the existing linking bars punching.

Ordering details

Description	Color	Type	Part Number	Pkg qty	Weight (1 pce) g
Feed-through 2 feed-through circuits	Grey	ZS4-D2	1SNK505210R0000	50	15.30
	Blue	ZS4-D2-BL	1SNK505220R0000	50	15.30
	Orange	ZS4-D2-OR	1SNK505230R0000	50	15.30

Main technical data

Connecting capacity		IEC	UL - CSA	Mounting instructions	
1 conductor per clamp	Rigid: Solid/Stranded	0.2 ... 4 mm ²	24 ... 12 AWG	Rail	TH 35-7.5, TH 35-15
	Flexible without ferrule	0.22 ... 4 mm ²		Wire stripping length	10 mm 0.393 in
	Flexible with non insulated ferrule	0.22 ... 4 mm ²	24 ... 12 AWG		
	Flexible with insulated ferrule	0.22 ... 2.5 mm ²	24 ... 14 AWG	Tool	Flat screwdriver Ø 3.5 mm Ø 0.138 in
	Gauge	A3-B3			
2 conductors per clamp	Rigid: Solid/Stranded	0.2 ... 1.5 mm ²	24 ... 16 AWG	Torque	0.6 Nm ± 0.1 5.31 lb.in ± 0.885
	Flexible without ferrule	0.2 ... 1.5 mm ²			
	Flexible with twin ferrule	0.22 ... 1.5 mm ²	24 ... 16 AWG		
Rated current / Rated cross section		29 A / 4 mm ²	20 A / 12 AWG		
Rated short-time withstand current (1s)		480 A			
Short Circuit Current Rating (with specific conditions)			100 kA		
Rated voltage		800 V	300 V		
Impulse withstand voltage		8000 V			
Protection		IP20	NEMA 1		
Increased safety Ex e		440 V 29 A IEC/EN 60079-7 - IM2 II 2 GD Ex eb I/II/III C - 300 V 20 A UL 60079-7 - Class I, Zone 1, AEx e II, Ex e II U			

The connecting capacity data for one Rigid: Solid/Stranded, or one Flexible conductor (when applicable) is a mandatory information required by IEC, UL and CSA standards (Copper conductors). All other data are provided as supplementary information only. For more details, please consult our CB, UL or CSA certificates and technical datasheet available on <http://www.TE.com>



Accessories

Description	Color	Type	Part Number	Pkg qty	Weight (1 pce) g	
1 End stops 10 mm 0.394 in	Dark grey	BAZH1	1SNK900102R0000	20	24.00	
2 End sections 2.55 mm 0.100 in	Dark grey	ES4-D2	1SNK505960R0000	20	4.10	
3 Jumper bars 2 poles 32 A (IEC)	Orange	JB5-2	1SNK905302R0000	50	1.30	
		3 poles 32 A (IEC)	JB5-3	1SNK905303R0000	50	2.00
		4 poles 32 A (IEC)	JB5-4	1SNK905304R0000	50	2.70
		5 poles 32 A (IEC)	JB5-5	1SNK905305R0000	50	3.50
		10 poles 32 A (IEC)	JB5-10	1SNK905310R0000	30	7.10
4 Test adapters For test plugs DIA 2 mm 0.079 in	Dark grey	TP2	1SNK900203R0000	20	1.70	
		TP4	1SNK900205R0000	20	2.40	
5 Test connectors 5.2 mm 0.205 in spacing	Dark grey	TC5	1SNK900200R0000	10	5.20	
		TC5-R1	1SNK900201R0000	10	5.20	
6 Shield connectors		SHB	1SNK900602R0000	20	4.90	
7 Label holders	Dark grey	LH-J	1SNK900606R0000	100	0.73	
8 Terminal block markers	White	MG-CPM 13 41790	1SNB041790R0512	1960	0.23	
		MC512	1SNK140000R0000	22	9.00	
	Grey	MC512PA	1SNK149999R0000	20	10.00	
		Universal wire markers holder	UMH	1SNK900611R0000	10	0.20

Complete list of accessories is indicated in the terminal block datasheet including end stops. Some accessories such as jumper bars may modify the terminal block's ratings. Complete information available in the accessories section of the catalog.

Technical data valid for copper conductors only.

ZS4-D1 screw clamp terminal blocks

Double deck with 1 feed-through circuit - 5.2 mm 0.205 in spacing



4 mm²
12 AWG

Description

- Ease one potential distribution on 4 independent screw clamps,
- Save space by connecting conductors up to 4 mm² (CB certified) 12 AWG in just 5.2 mm 0.205 in spacing.

Ordering details

Description	Color	Type	Part Number	Pkg qty	Weight (1 pce) g
Feed-through 1 feed-through circuit	Grey <input type="checkbox"/>	ZS4-D1	1SNK505211R0000	50	15.30

Main technical data

Connecting capacity		IEC	UL - CSA	Mounting instructions	
1 conductor per clamp	Rigid: Solid/Stranded	0.2 ... 4 mm ²	24 ... 12 AWG	Rail	TH 35-7.5, TH 35-15
	Flexible without ferrule	0.22 ... 4 mm ²		Wire stripping length	10 mm 0.393 in
	Flexible with non insulated ferrule	0.22 ... 4 mm ²	24 ... 12 AWG		
	Flexible with insulated ferrule	0.22 ... 2.5 mm ²	24 ... 14 AWG		
Gauge		A3-B3		Tool	Flat screwdriver Ø 3.5 mm Ø 0.138 in
2 conductors per clamp	Rigid: Solid/Stranded	0.2 ... 1.5 mm ²	24 ... 16 AWG		
	Flexible without ferrule	0.2 ... 1.5 mm ²			
	Flexible with twin ferrule	0.22 ... 1.5 mm ²	24 ... 16 AWG		
Rated current / Rated cross section		29 A / 4 mm ²	20 A / 12 AWG	Torque	0.6 Nm ± 0.1 5.31 lb.in ± 0.885
Rated short-time withstand current (1s)		480 A			
Short Circuit Current Rating (with specific conditions)			100 kA		
Rated voltage		800 V	300 V		
Impulse withstand voltage		8000 V			
Protection		IP20	NEMA 1		



1SNK161015F0014

ZS4-D1

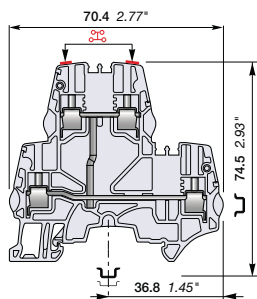

5.2 mm 0.205 in spacing

Increased safety Ex e 440 V 29 A IEC/EN 60079-7 - IM2 II 2 GD Ex eb III/IIIC - 300 V 20 A UL 60079-7 - Class I, Zone 1, AEx e II, Ex e II U

The connecting capacity data for one Rigid: Solid/Stranded, or one Flexible conductor (when applicable) is a mandatory information required by IEC, UL and CSA standards (Copper conductors). All other data are provided as supplementary information only. For more details, please consult our CB, UL or CSA certificates and technical datasheet available on <http://www.TE.com>

CE	CB	RoHS	UL US	CSA	EAC Ex	ATEX	IECEx	BFR-Ex e II	UL US	BV	DNV	Pina

Accessories

Description	Color	Type	Part Number	Pkg qty	Weight (1 pce) g	
1 End stops	Dark grey <input type="checkbox"/>	BAZH1	1SNK900102R0000	20	24.00	
2 End sections	Dark grey <input type="checkbox"/>	ES4-D2	1SNK505960R0000	20	4.10	
3 Jumper bars	Orange <input type="checkbox"/>	2 poles	JB5-2	1SNK905302R0000	50	1.30
		3 poles	JB5-3	1SNK905303R0000	50	2.00
		4 poles	JB5-4	1SNK905304R0000	50	2.70
		5 poles	JB5-5	1SNK905305R0000	50	3.50
		10 poles	JB5-10	1SNK905310R0000	30	7.10
4 Test adapters	Dark grey <input type="checkbox"/>	For test plugs DIA 2 mm 0.079 in	TP2	1SNK900203R0000	20	1.70
		For test plugs DIA 4 mm 0.157 in	TP4	1SNK900205R0000	20	2.40
5 Test connectors	Dark grey <input type="checkbox"/>	5.2 mm 0.205 in spacing	TC5	1SNK900200R0000	10	5.20
		End module, 5.2 mm 0.205 in	TC5-R1	1SNK900201R0000	10	5.20
6 Shield connectors		SHB	1SNK900602R0000	20	4.90	
7 Label holders	Dark grey <input type="checkbox"/>	LH-J	1SNK900606R0000	100	0.73	
8 Terminal block markers	White <input type="checkbox"/>	Blank marker	MG-CPM 13 41790	1SNB041790R0512	1960	0.23
		Blank card	MC512	1SNK140000R0000	22	9.00
			MC512PA	1SNK149999R0000	20	10.00
		Universal wire markers holder	Grey <input type="checkbox"/>	UMH	1SNK900611R0000	10

Complete list of accessories is indicated in the terminal block datasheet including end stops. Some accessories such as jumper bars may modify the terminal block's ratings: Complete information available in the accessories section of the catalog.



Technical data valid for copper conductors only.

ZS6-D2 screw clamp terminal blocks

Double deck with 2 feed-through circuits - 6 mm 0.236 in spacing



ZS6-D2

Description

- Save space with double deck terminal blocks: 2 independent circuits connected in just 6 mm 0.236 in spacing,
- Customize yourself the ZS6-D2 by soldering electronic components (up to 8.8 mm x 3.2 mm 0.346 x 0.125 in) in the existing linking bars punching,
- Boost the performances: ZS6-D... with ES4-D2 end section is rated 1000 V DC IEC, perfectly adapted to solar applications.

Ordering details

Description	Color	Type	Part Number	Pkg qty	Weight (1 pce) g
Feed-through 2 feed-through circuits	Grey	ZS6-D2	1SNK506210R0000	50	18.40
	Blue	ZS6-D2-BL	1SNK506220R0000	50	18.40
	Orange	ZS6-D2-OR	1SNK506230R0000	50	18.40
	Yellow	ZS6-D2-YL	1SNK506260R0000	50	18.40
	Red	ZS6-D2-RD	1SNK506262R0000	50	18.40
	White	ZS6-D2-WH	1SNK506265R0000	50	18.40
	Black	ZS6-D2-BK	1SNK506266R0000	50	18.40

Main technical data

Connecting capacity	IEC	UL - CSA	Mounting instructions
1 conductor per clamp	Rigid: Solid/Stranded	0.2 ... 6 mm ²	24 ... 10 AWG
	Flexible without ferrule	0.2 ... 6 mm ²	24 ... 10 AWG
	Flexible with non insulated ferrule	0.22 ... 4 mm ²	24 ... 12 AWG
	Flexible with insulated ferrule	0.22 ... 4 mm ²	24 ... 12 AWG
	Gauge	A4-B3	
2 conductors per clamp	Rigid: Solid/Stranded	0.2 ... 2.5 mm ²	24 ... 14 AWG
	Flexible without ferrule	0.2 ... 2.5 mm ²	24 ... 14 AWG
	Flexible with twin ferrule	0.22 ... 2.5 mm ²	24 ... 14 AWG
Rated current / Rated cross section	40 A / 6 mm ²	30 A / 10 AWG	
Rated short-time withstand current (1s)	720 A		
Short Circuit Current Rating (with specific conditions)		100 kA	
Rated voltage	800 V	300 V	
Impulse withstand voltage	8000 V		
Protection	IP20	NEMA 1	

Increased safety Ex e 440 V 40 A IEC/EN 60079-7 - IM2 II 2 GD Ex eb I/II/III - 300 V 30 A UL 60079-7 - Class I, Zone 1, AEx e II, Ex e II U

The connecting capacity data for one Rigid: Solid/Stranded, or one Flexible conductor (when applicable) is a mandatory information required by IEC, UL and CSA standards (Copper conductors). All other data are provided as supplementary information only. For more details, please consult our CB, UL or CSA certificates and technical datasheet available on <http://www.TE.com>

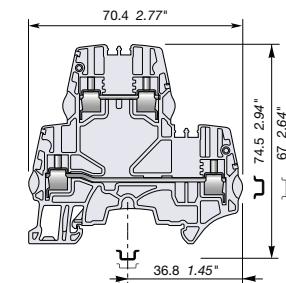

6 mm 0.236 in spacing

Accessories

Description	Color	Type	Part Number	Pkg qty	Weight (1 pce) g	
1 End stops	Dark grey	BAZH1	1SNK900102R0000	20	24.00	
2 End sections	Dark grey	ES4-D2	1SNK505960R0000	20	4.10	
3 Jumper bars	Orange	2 poles	JB6-2	1SNK906302R0000	50	1.30
		3 poles	JB6-3	1SNK906303R0000	50	2.10
		4 poles	JB6-4	1SNK906304R0000	50	2.90
		5 poles	JB6-5	1SNK906305R0000	50	3.60
		10 poles	JB6-10	1SNK906310R0000	20	7.40
4 Test adapters	Dark grey	For test plugs DIA 2 mm 0.079 in	TP2	1SNK900203R0000	20	1.70
		For test plugs DIA 4 mm 0.157 in	TP4	1SNK900205R0000	20	2.40
5 Test connectors	Dark grey	TC5-R1	1SNK900201R0000	10	5.20	
6 Spacers	Dark grey	ES-TC6	1SNK900105R0000	10	0.80	
7 Shield connectors		SHB	1SNK900602R0000	20	4.90	
8 Terminal block markers	White	Blank marker	MG-CPM 13 41791	1SNB041791R0612	1680	0.27
		Blank card	MC612	1SNK150000R0000	22	10.00
			MC612PA	1SNK159999R0000	20	11.00
		Universal wire markers holder	Grey	UMH	1SNK900611R0000	10

Complete list of accessories is indicated in the terminal block datasheet including end stops. Some accessories such as jumper bars may modify the terminal block's ratings: Complete information available in the accessories section of the catalog.

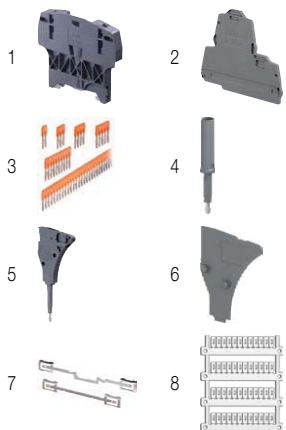

Ground screw clamp terminal blocks

Description	Color	Type	Part Number	Pkg qty	Weight (1 pce) g
Ground Profile aligned with ZS6-D2 and ZS6-D1	Green-yellow	ZS6-D1-PE	1SNK506250R0000	20	18.40

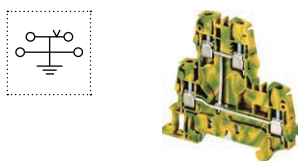

Technical data valid for copper conductors only.

ZS6-D1 screw clamp terminal blocks

Double deck with 1 feed-through circuit - 6 mm 0.236 in spacing



ZS6-D1

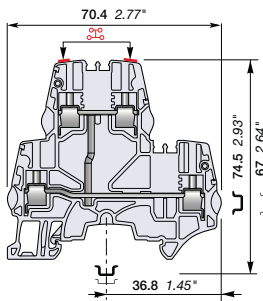

6 mm 0.236 in spacing

Description

- Ease one potential distribution on 4 independent screw clamps,
- Save space by connecting conductors up to 6 mm² 10 AWG in just 6 mm 0.236 in spacing,
- Boost the performances: ZS6-D... with ES4-D2 end section is rated 1000 V DC IEC, perfectly adapted to solar applications.

Ordering details

Description	Color	Type	Part Number	Pkg qty	Weight (1 pce) g
Feed-through 1 feed-through circuit	Grey <input type="checkbox"/>	ZS6-D1	1SNK506211R0000	50	18.40
	Red <input type="checkbox"/>	ZS6-D1-RD	1SNK506214R0000	50	18.40

Main technical data

Connecting capacity		IEC	UL - CSA	Mounting instructions	
1 conductor per clamp	Rigid: Solid/Stranded	0.2 ... 6 mm ²	24 ... 10 AWG	Rail	TH 35-7.5, TH 35-15
	Flexible without ferrule	0.2 ... 6 mm ²		Wire stripping length	10 mm 0.393 in
	Flexible with non insulated ferrule	0.22 ... 4 mm ²	24 ... 12 AWG		
	Flexible with insulated ferrule	0.22 ... 4 mm ²	24 ... 12 AWG		
Gauge		A4-B3		Tool	Flat screwdriver Ø 4 mm Ø 0.157 in
2 conductors per clamp	Rigid: Solid/Stranded	0.2 ... 2.5 mm ²	24 ... 14 AWG		
	Flexible without ferrule	0.2 ... 2.5 mm ²			
	Flexible with twin ferrule	0.22 ... 2.5 mm ²	24 ... 14 AWG		
Rated current / Rated cross section		40 A / 6 mm ²	30 A / 10 AWG	Torque	0.85 Nm ± 0.15 7.52 lb.in ± 1.33
Rated short-time withstand current (1s)		720 A			
Short Circuit Current Rating (with specific conditions)			100 kA		
Rated voltage		800 V	300 V		
Impulse withstand voltage		8000 V			
Protection		IP20	NEMA 1		

Increased safety Ex e 440 V 40 A IEC/EN 60079-7 - IM2 II 2 GD Ex eb I/IIIC - 300 V 30 A UL 60079-7 - Class I, Zone 1, AEx e II, Ex e II U

The connecting capacity data for one Rigid: Solid/Stranded, or one Flexible conductor (when applicable) is a mandatory information required by IEC, UL and CSA standards (Copper conductors). All other data are provided as supplementary information only. For more details, please consult our CB, UL or CSA certificates and technical datasheet available on <http://www.TE.com>



Accessories

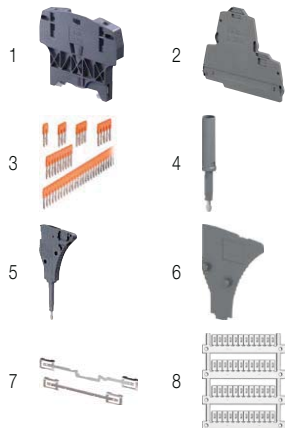

Description	Color	Type	Part Number	Pkg qty	Weight (1 pce) g	
1 End stops	Dark grey <input type="checkbox"/>	BAZH1	1SNK900102R0000	20	24.00	
2 End sections	Dark grey <input type="checkbox"/>	ES4-D2	1SNK505960R0000	20	4.10	
3 Jumper bars	Orange <input type="checkbox"/>	2 poles	JB6-2	1SNK906302R0000	50	1.30
		3 poles	JB6-3	1SNK906303R0000	50	2.10
		4 poles	JB6-4	1SNK906304R0000	50	2.90
		5 poles	JB6-5	1SNK906305R0000	50	3.60
		10 poles	JB6-10	1SNK906310R0000	20	7.40
4 Test adapters	Dark grey <input type="checkbox"/>	For test plugs DIA 2 mm 0.079 in	TP2	1SNK900203R0000	20	1.70
		For test plugs DIA 4 mm 0.157 in	TP4	1SNK900205R0000	20	2.40
5 Test connectors	Dark grey <input type="checkbox"/>	TC5-R1	1SNK900201R0000	10	5.20	
6 Spacers	Dark grey <input type="checkbox"/>	ES-TC6	1SNK900105R0000	10	0.80	
7 Shield connectors		SHB	1SNK900602R0000	20	4.90	
8 Terminal block markers	White <input type="checkbox"/>	Blank marker	MG-CPM 13 41791	1SNB041791R0612	1680	0.27
		Blank card	MC612	1SNK150000R0000	22	10.00
		Universal wire markers holder	Grey <input type="checkbox"/>	UMH	1SNK900611R0000	10

Complete list of accessories is indicated in the terminal block datasheet including end stops.

Some accessories such as jumper bars may modify the terminal block's ratings: Complete information available in the accessories section of the catalog.

Technical data valid for copper conductors only.



ZS6-D2-PE screw clamp terminal blocks

Double deck with 1 feed-through circuit and 1 ground circuit - 6 mm 0.236 in spacing



ZS6-D2-PE

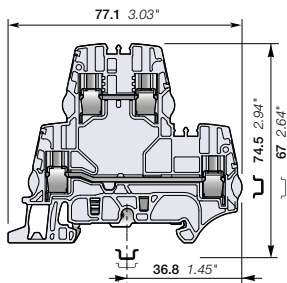

6 mm 0.236 in spacing

Description

- Save space with ZS6-D2-PE terminal blocks: 1 feed-through circuit and 1 ground circuit in just 6 mm 0.236 in spacing,
- Customize yourself the ZS6-D2-PE terminal blocks by soldering electronic components (up to 8.8 mm x 3.2 mm 0.346 x 0.125 in) in the existing linking bars punching.

Ordering details

Description	Color	Type	Part Number	Pkg qty	Weight (1 pce) g
Feed-through + ground	Grey <input type="checkbox"/>	ZS6-D2-PE	1SNK506212R0000	50	18.40

Main technical data

Connecting capacity		IEC	UL - CSA	Mounting instructions	
1 conductor per clamp	Rigid: Solid/Stranded	0.2 ... 6 mm ²	24 ... 10 AWG	Rail	TH 35-7.5, TH 35-15
	Flexible without ferrule	0.22 ... 6 mm ²		Wire stripping length	10 mm 0.393 in
	Flexible with non insulated ferrule	0.22 ... 4 mm ²	24 ... 12 AWG		
	Flexible with insulated ferrule	0.22 ... 4 mm ²	24 ... 12 AWG		
	Gauge	A4-B3			
2 conductors per clamp	Rigid: Solid/Stranded	0.2 ... 2.5 mm ²	24 ... 14 AWG	Tool	Flat screwdriver Ø 4 mm Ø 0.157 in
	Flexible without ferrule	0.2 ... 2.5 mm ²	24 ... 14 AWG		
	Flexible with twin ferrule	0.22 ... 2.5 mm ²	24 ... 14 AWG		
Rated current / Rated cross section		41 A / 6 mm ²	30 A / 10 AWG	Torque	0.85 Nm ± 0.15 7.52 lb.in ± 1.33
Rated short-time withstand current (1s)		720 A			
Short Circuit Current Rating (with specific conditions)					
Rated voltage		800 V	300 V		
Impulse withstand voltage		8000 V			
Protection		IP20	NEMA 1		

The connecting capacity data for one Rigid: Solid/Stranded, or one Flexible conductor (when applicable) is a mandatory information required by IEC, UL and CSA standards (Copper conductors). All other data are provided as supplementary information only. For more details, please consult our CB, UL or CSA certificates and technical datasheet available on <http://www.TE.com>

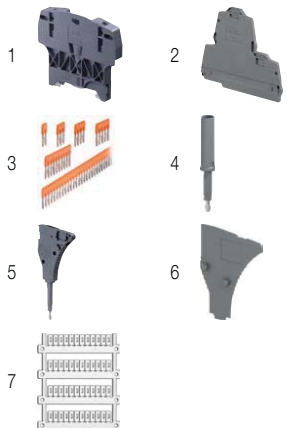
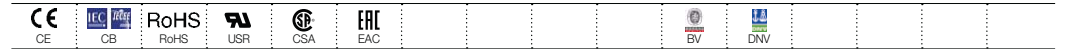

Accessories

Description	Color	Type	Part Number	Pkg qty	Weight (1 pce) g	
1 End stops	Dark grey <input type="checkbox"/>	BAZH1	1SNK900102R0000	20	24.00	
2 End sections	Dark grey <input type="checkbox"/>	ES4-D2	1SNK505960R0000	20	4.10	
3 Jumper bars	Orange <input type="checkbox"/>	2 poles	JB6-2	1SNK906302R0000	50	1.30
		3 poles	JB6-3	1SNK906303R0000	50	2.10
		4 poles	JB6-4	1SNK906304R0000	50	2.90
		5 poles	JB6-5	1SNK906305R0000	50	3.60
		10 poles	JB6-10	1SNK906310R0000	20	7.40
4 Test adapters	Dark grey <input type="checkbox"/>	TP4	1SNK900205R0000	20	2.40	
5 Test connectors	Dark grey <input type="checkbox"/>	TC5-R1	1SNK900201R0000	10	5.20	
6 Spacers	Dark grey <input type="checkbox"/>	ES-TC6	1SNK900105R0000	10	0.80	
7 Terminal block markers	White <input type="checkbox"/>	Blank marker	MG-CPM 13 41791	1SNB041791R0612	1680	0.27
		Blank card	MC612	1SNK150000R0000	22	10.00
			MC612PA	1SNK159999R0000	20	11.00
	Universal wire markers holder	Grey <input type="checkbox"/>	UMH	1SNK900611R0000	10	0.20

Complete list of accessories is indicated in the terminal block datasheet including end stops. Some accessories such as jumper bars may modify the terminal block's ratings: Complete information available in the accessories section of the catalog.



Feed-through screw clamp terminal blocks

Description	Color	Type	Part Number	Pkg qty	Weight (1 pce) g
Feed-through	Grey <input type="checkbox"/>	ZS6-D2	1SNK506210R0000	50	18.40

Technical data valid for copper conductors only.

ZS6-D1-PE screw clamp terminal blocks

Double deck with 1 ground circuit - 6 mm 0.236 in spacing

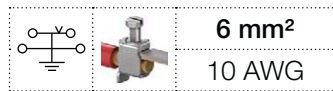

ZS6-D1-PE

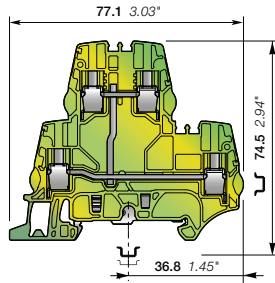

6 mm 0.236 in spacing

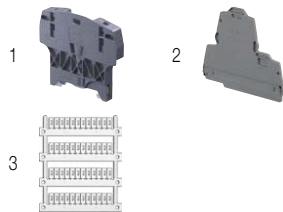

Description

- Save space with double deck ground terminal blocks aligned with ZS6-D2 double deck terminal blocks for convenient cabling process and circuit configuration,
- Benefit from our screwless rail connection: non operator independant, secured snap on or remove from the rail, performances above the requirements of IEC 60947-7-2 standard.

Ordering details

Description	Color	Type	Part Number	Pkg qty	Weight (1 pce) g
Ground 1 ground circuit	Green-yellow	ZS6-D1-PE	1SNK506250R0000	20	18.40

Main technical data

Connecting capacity		IEC	UL - CSA	Mounting instructions	
1 conductor per clamp	Rigid: Solid/Stranded	0.2 ... 6 mm ²	24 ... 10 AWG	Rail	TH 35-7.5, TH 35-15
	Flexible without ferrule	0.22 ... 6 mm ²		Wire stripping length	10 mm 0.393 in
	Flexible with non insulated ferrule	0.22 ... 4 mm ²	24 ... 12 AWG		
	Flexible with insulated ferrule	0.22 ... 4 mm ²	24 ... 12 AWG	Tool	Flat screwdriver Ø 4 mm Ø 0.157 in
	Gauge	A4-B3			
Rated cross section		6 mm ²	10 AWG	Torque	0.85 Nm ± 0.15 7.52 lb.in ± 1.33
Rated short-time withstand current (1s)		720 A			
Protection		IP20	NEMA 1		

The connecting capacity data for one Rigid: Solid/Stranded, or one Flexible conductor (when applicable) is a mandatory information required by IEC, UL and CSA standards (Copper conductors). All other data are provided as supplementary information only. For more details, please consult our CB, UL or CSA certificates and technical datasheet available on <http://www.TE.com>

CE	IEC	RoHS	UL	CSA	EAC	BV	DNV
CE	CB	RoHS	ULR	CSA	EAC	BV	DNV

Accessories

Description	Color	Type	Part Number	Pkg qty	Weight (1 pce) g
1 End stops	Dark grey	BAZH1	1SNK900102R0000	20	24.00
2 End sections	Dark grey	ES4-D2	1SNK505960R0000	20	4.10
3 Terminal block markers	White	MG-CPM 13 41791	1SNB041791R0612	1680	0.27
		MC612	1SNK150000R0000	22	10.00
		MC612PA	1SNK159999R0000	20	11.00
Universal wire markers holder	Grey	UMH	1SNK900611R0000	10	0.20

Complete list of accessories is indicated in the terminal block datasheet including end stops.

Some accessories such as jumper bars may modify the terminal block's ratings: Complete information available in the accessories section of the catalog.

Technical data valid for copper conductors only.

ZS4-D2-S screw clamp terminal blocks

Double deck with 1 disconnect circuit and 1 feed-through circuit - 5.2 mm 0.205 in spacing



ZS4-D2-S

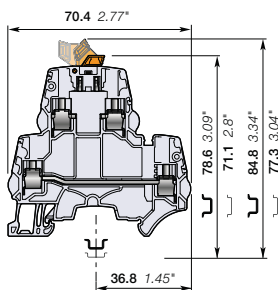

5.2 mm 0.205 in spacing

Description

- Save space: connect one complete circuit on a single block featuring disconnect and feed-through for the return circuit in just 5.2 mm 0.205 in spacing,
- Same profile as ZS4-D... double deck terminal blocks: convenient cabling process, aligned jumpers, markers and common end section.

Ordering details

Description	Color	Type	Part Number	Pkg qty	Weight (1 pce) g
Feed-through + disconnect	Grey <input type="checkbox"/>	ZS4-D2-S	1SNK505315R0000	50	15.90

Main technical data

Connecting capacity		IEC	UL - CSA	Mounting instructions	
1 conductor per clamp	Rigid: Solid/Stranded	0.2 ... 4 mm ²	24 ... 10 AWG	Rail	TH 35-7.5, TH 35-15
	Flexible without ferrule	0.22 ... 4 mm ²	24 ... 12 AWG	Wire stripping length	10.5 mm 0.413 in
	Flexible with non insulated ferrule	0.22 ... 4 mm ²	24 ... 12 AWG		
	Flexible with insulated ferrule	0.22 ... 2.5 mm ²	24 ... 14 AWG		
	Gauge	A3-B3			
2 conductors per clamp	Rigid: Solid/Stranded	0.2 ... 1.5 mm ²	24 ... 16 AWG	Tool	Flat screwdriver Ø 3.5 mm Ø 0.138 in
	Flexible without ferrule	0.2 ... 1.5 mm ²	24 ... 16 AWG		
	Flexible with twin ferrule	0.22 ... 1.5 mm ²	24 ... 16 AWG		
Disconnect circuit				Torque	0.6 Nm ± 0.1 5.31 lb.in ± 0.885
Rated current / Rated cross section		25 A / 4 mm ²	27 A / 10 AWG		
Feed-through circuit					
Rated current / Rated cross section		29 A / 4 mm ²	27 A / 10 AWG		
Rated short-time withstand current (1s)		480 A			
Rated voltage		630 V	300 V		
Impulse withstand voltage		8000 V			
Protection		IP20	NEMA 1		

Recommendation for best usage: in horizontal assemblies, disconnect terminal blocks should be mounted with fixed foot on top (power side) so that the disconnect knife does not partially close through gravity. Furthermore, as specified per IEC 60947-7-1, disconnect terminal blocks are intended to be used for temporary disconnection at zero potential and at no load.

The connecting capacity data for one Rigid: Solid/Stranded, or one Flexible conductor (when applicable) is a mandatory information required by IEC, UL and CSA standards (Copper conductors). All other data are provided as supplementary information only. For more details, please consult our CB, UL or CSA certificates and technical datasheet available on <http://www.TE.com>

--	--	--	--	--	--	--	--

Accessories

Description	Color	Type	Part Number	Pkg qty	Weight (1 pce) g	
1 End stops	Dark grey <input checked="" type="checkbox"/>	BAZH1	1SNK900102R0000	20	24.00	
2 End sections	Dark grey <input checked="" type="checkbox"/>	ES4-D2	1SNK505960R0000	20	4.10	
3 Jumper bars	Orange <input checked="" type="checkbox"/>	2 poles	JB5-2	1SNK905302R0000	50	1.30
		3 poles	JB5-3	1SNK905303R0000	50	2.00
		4 poles	JB5-4	1SNK905304R0000	50	2.70
		5 poles	JB5-5	1SNK905305R0000	50	3.50
		10 poles	JB5-10	1SNK905310R0000	30	7.10
		50 poles	JB5-50	1SNK905350R0000	10	36.00
4 Test adapters	Dark grey <input checked="" type="checkbox"/>	For test plugs DIA 2 mm 0.079 in	TP2	1SNK900203R0000	20	1.70
		For test plugs DIA 4 mm 0.157 in	TP4	1SNK900205R0000	20	2.40
5 Shield connectors		SHB	1SNK900602R0000	20	4.90	
6 Terminal block markers	White <input type="checkbox"/>	Blank marker	MG-CPM 13 41790	1SNB041790R0512	1960	0.23
		Blank card	MC512	1SNK140000R0000	22	9.00
			MC512PA	1SNK149999R0000	20	10.00
		Universal wire markers holder	Grey <input type="checkbox"/>	UMH	1SNK900611R0000	10

Complete list of accessories is indicated in the terminal block datasheet including end stops. Some accessories such as jumper bars may modify the terminal block's ratings: Complete information available in the accessories section of the catalog.

Technical data valid for copper conductors only.

ZS4-D2-S-T screw clamp terminal blocks

Double deck with 1 disconnect circuit with test socket screws and 1 feed-through circuit - 5.2 mm 0.205 in spacing

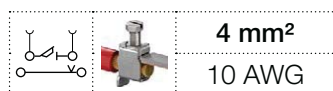

4 mm²
10 AWG

Description

Find the same functionalities as ZS4-D2-S, upgraded with the two built-in test socket screws meant to ease your signal testing during commissioning and maintenance.

Ordering details

Description	Color	Type	Part Number	Pkg qty	Weight (1 pce) g
Feed-through + disconnect	Grey <input type="checkbox"/>	ZS4-D2-S-T2	1SNK505316R0000	50	16.20

Main technical data

Connecting capacity		IEC	UL - CSA	Mounting instructions	
1 conductor per clamp	Rigid: Solid/Stranded	0.2 ... 4 mm ²	24 ... 10 AWG	Rail	TH 35-7.5, TH 35-15
	Flexible without ferrule	0.22 ... 4 mm ²	24 ... 12 AWG	Wire stripping length	10.5 mm 0.413 in
	Flexible with non insulated ferrule	0.22 ... 4 mm ²	24 ... 12 AWG	Tool	Flat screwdriver Ø 3.5 mm Ø 0.138 in
	Flexible with insulated ferrule	0.22 ... 2.5 mm ²	24 ... 14 AWG		
Gauge		A3-B3		Torque	0.6 Nm ± 0.1 5.31 lb.in ± 0.885
2 conductors per clamp	Rigid: Solid/Stranded	0.2 ... 1.5 mm ²	24 ... 16 AWG		
	Flexible without ferrule	0.2 ... 1.5 mm ²	24 ... 16 AWG		
	Flexible with twin ferrule	0.22 ... 1.5 mm ²	24 ... 16 AWG		
Disconnect circuit					
Rated current / Rated cross section		25 A / 4 mm ²	27 A / 10 AWG		
Feed-through circuit					
Rated current / Rated cross section		29 A / 4 mm ²	27 A / 10 AWG		
Rated short-time withstand current (1s)		480 A			
Rated voltage		630 V	300 V		
Impulse withstand voltage		8000 V			
Protection		IP20	NEMA 1		

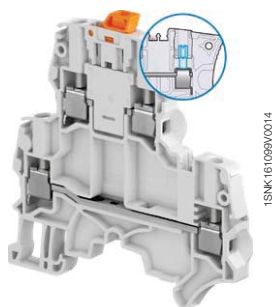

ZS4-D2-S-T

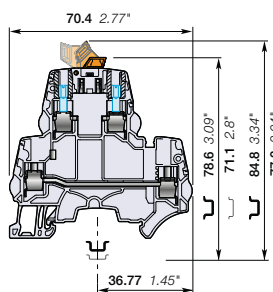

5.2 mm 0.205 in spacing

Recommendation for best usage: in horizontal assemblies, disconnect terminal blocks should be mounted with fixed foot on top (power side) so that the disconnect knife does not partially close through gravity. Furthermore, as specified per IEC 60947-7-1, disconnect terminal blocks are intended to be used for temporary disconnection at zero potential and at no load.

The connecting capacity data for one Rigid: Solid/Stranded, or one Flexible conductor (when applicable) is a mandatory information required by IEC, UL and CSA standards (Copper conductors). All other data are provided as supplementary information only. For more details, please consult our CB, UL or CSA certificates and technical datasheet available on <http://www.TE.com>

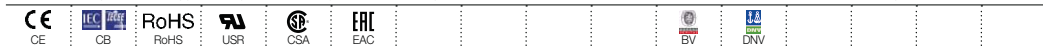

Accessories

Description	Color	Type	Part Number	Pkg qty	Weight (1 pce) g	
1 End stops	Dark grey <input checked="" type="checkbox"/>	BAZH1	1SNK900102R0000	20	24.00	
2 End sections	Dark grey <input checked="" type="checkbox"/>	ES4-D2	1SNK505960R0000	20	4.10	
3 Jumper bars	Orange <input checked="" type="checkbox"/>	2 poles	JB5-2	1SNK905302R0000	50	1.30
		3 poles	JB5-3	1SNK905303R0000	50	2.00
		4 poles	JB5-4	1SNK905304R0000	50	2.70
		5 poles	JB5-5	1SNK905305R0000	50	3.50
		10 poles	JB5-10	1SNK905310R0000	30	7.10
		50 poles	JB5-50	1SNK905350R0000	10	36.00
4 Test adapters	Dark grey <input checked="" type="checkbox"/>	For test plugs DIA 2 mm 0.079 in	TP2	1SNK900203R0000	20	1.70
		For test plugs DIA 4 mm 0.157 in	TP4	1SNK900205R0000	20	2.40
5 Shield connectors		SHB	1SNK900602R0000	20	4.90	
6 Terminal block markers	White <input type="checkbox"/>	Blank marker	MG-CPM 13 41790	1SNB041790R0512	1960	0.23
		Blank card	MC512	1SNK140000R0000	22	9.00
		Universal wire markers holder	UMH	1SNK149999R0000	20	10.00
	Grey <input type="checkbox"/>			1SNK900611R0000	10	0.20

Complete list of accessories is indicated in the terminal block datasheet including end stops.

Some accessories such as jumper bars may modify the terminal block's ratings: Complete information available in the accessories section of the catalog.

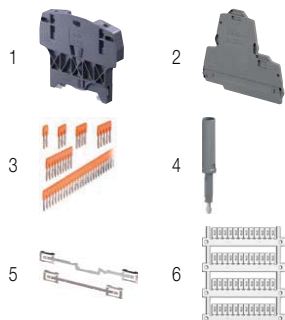

Technical data valid for copper conductors only.

ZS4-D2-SF1 screw clamp terminal blocks

Double deck with 1 fuse circuit and 1 feed-through circuit - 8 mm 0.315 in spacing



ZS4-D2-SF1

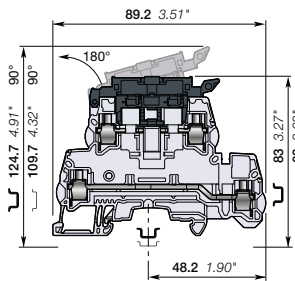

8 mm 0.315 in spacing

Description

- Save space: connect one complete circuit on a single block featuring fuse and feed-through for the return circuit,
- Protect your circuit with either 5X20 or 5X25 fuse (fuse not supplied with the terminal blocks),
- High performances product: compliant with IEC 60947-7-3 standard and jumper channel for the feed-through circuit.

Ordering details

Description	Color	Type	Part Number	Pkg qty	Weight (1 pce)
Feed-through + fuse	1 fuse circuit and 1 feed-through circuit	Grey, dark grey	ZS4-D2-SF1	1SNK508425R0000	50 27.50

Main technical data

Connecting capacity		IEC	UL - CSA	Mounting instructions	
1 conductor per clamp	Rigid: Solid/Stranded	0.2 ... 6 mm ²	24 ... 10 AWG	Rail	 TH 35-7.5, TH 35-15
	Flexible without ferrule	0.22 ... 4 mm ²	24 ... 10 AWG		
	Flexible with non insulated ferrule	0.22 ... 4 mm ²	24 ... 12 AWG	Wire stripping length	 11 mm 0.433 in
	Flexible with insulated ferrule	0.22 ... 4 mm ²	24 ... 12 AWG		
Gauge		A3-B3			
2 conductors per clamp	Rigid: Solid/Stranded	0.2 ... 2.5 mm ²	24 ... 14 AWG	Tool	 Flat screwdriver Ø 3.5 mm Ø 0.138 in
	Flexible without ferrule	0.2 ... 2.5 mm ²	24 ... 14 AWG		
	Flexible with twin ferrule	0.22 ... 2.5 mm ²	24 ... 14 AWG		
Disconnect circuit				Torque	 0.6 Nm ± 0.1 5.31 lb.in ± 0.885
Rated current / Rated cross section		6.3 A / 4 mm ²	12 A / 10 AWG		
Feed-through circuit					
Rated current / Rated cross section		32 A / 4 mm ²	30 A / 10 AWG		
Rated voltage		800 V	300 V		
Impulse withstand voltage		8000 V			
Protection		IP20	NEMA 1		

Separate arrangement		Assembly composed of 1 fuse terminal block in between non fuse terminal blocks	Overload and short-circuit protection	2.5 W
			Exclusive short-circuit protection	4 W
Compound arrangement		Assembly composed of 5 fuse terminal blocks	Overload and short-circuit protection	1.6 W
			Exclusive short-circuit protection	4 W

The connecting capacity data for one Rigid: Solid/Stranded, or one Flexible conductor (when applicable) is a mandatory information required by IEC, UL and CSA standards (Copper conductors). All other data are provided as supplementary information only. For more details, please consult our CB, UL or CSA certificates and technical datasheet available on <http://www.TE.com>

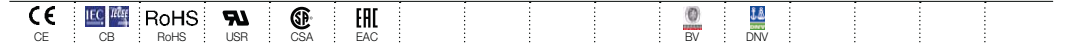

Accessories

Description	Color	Type	Part Number	Pkg qty	Weight (1 pce)	
1 End stops	Dark grey	BAZH1	1SNK900102R0000	20	24.00	
2 End sections	Dark grey	ES4-D2-SF1	1SNK508911R0000	20	5.00	
3 Jumper bars	Orange	2 poles	JB8-2	1SNK908302R0000	50	2.70
		3 poles	JB8-3	1SNK908303R0000	50	4.10
		4 poles	JB8-4	1SNK908304R0000	50	5.60
		5 poles	JB8-5	1SNK908305R0000	40	7.00
		10 poles	JB8-10	1SNK908310R0000	20	14.20
4 Lateral jumper bars	Grey	PC81-10	1SNA173523R1100	10	5.00	
5 Test adapters	Dark grey	For test plugs DIA 2 mm 0.079 in	TP2	1SNK900203R0000	20	1.70
		For test plugs DIA 4 mm 0.157 in	TP4	1SNK900205R0000	20	2.40
6 Test connectors	Dark grey	5.2 mm 0.205 in spacing	TC5	1SNK900200R0000	10	5.20
		End module, 5.2 mm 0.205 in	TC5-R1	1SNK900201R0000	10	5.20
7 Spacers	Dark grey	ES-TC8	1SNK900104R0000	10	1.40	
8 Assembly rods		2 poles	TGA8	1SNA168672R1100	10	1.00
		3 poles	TGA8	1SNA168673R1200	10	1.50
		4 poles	TGA8	1SNA168674R1300	10	2.00
9 Terminal block markers	White	Blank marker	MG-CPM 13 41791	1SNB041791R0612	1680	0.27
		Blank card	MC812	1SNK160000R0000	22	10.00
			MC812PA	1SNK169999R0000	20	14.00
	Universal wire markers holder	Grey	UMH	1SNK900611R0000	10	0.20

Complete list of accessories is indicated in the terminal block datasheet including end stops. Some accessories such as jumper bars may modify the terminal block's ratings: Complete information available in the accessories section of the catalog.

Technical data valid for copper conductors only.

ZS4-D2-SF1-R screw clamp terminal blocks

Double deck with 1 fuse circuit with blown fuse indicator and 1 feed-through circuit - 8 mm 0.315 in spacing

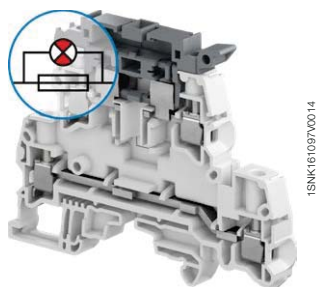

ZS4-D2-SF1-R

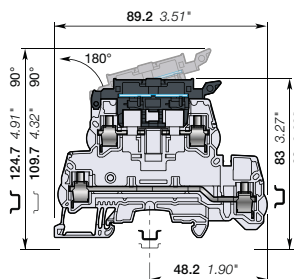

8 mm 0.315 in spacing

Description

- Find the same functionalities as ZS4-D2-SF1, upgraded with our integrated blown fuse indicator (with leakage current < 0.5 mA),
- Only one part number needed to fit AC / DC 24 V up to 110 V.

Ordering details

Description	Color	Type	Part Number	Pkg qty	Weight (1 pce) g
Feed-through + fuse	Grey, dark grey	ZS4-D2-SF1-R3	1SNK508424R0000	50	29.40
		ZS4-D2-SF1-R1	1SNK508423R0000	50	29.40

Main technical data

Connecting capacity	IEC	UL - CSA	Rail	Mounting instructions	
1 conductor per clamp	Rigid: Solid/Stranded	0.2 ... 6 mm ²	24 ... 10 AWG	Wire stripping length	TH 35-7.5, TH 35-15 11 mm 0.433 in
	Flexible without ferrule	0.22 ... 4 mm ²	24 ... 12 AWG		
	Flexible with non insulated ferrule	0.22 ... 4 mm ²	24 ... 12 AWG	Tool	Flat screwdriver Ø 3.5 mm Ø 0.138 in
	Flexible with insulated ferrule	0.22 ... 4 mm ²	24 ... 12 AWG		
2 conductors per clamp	Rigid: Solid/Stranded	0.2 ... 2.5 mm ²	24 ... 14 AWG	Torque	0.6 Nm ± 0.1 5.31 lb.in ± 0.885
	Flexible without ferrule	0.2 ... 2.5 mm ²	24 ... 14 AWG		
	Flexible with twin ferrule	0.22 ... 2.5 mm ²	24 ... 14 AWG		
Disconnect circuit					
Rated current / Rated cross section		6.3 A / 4 mm ²	12 A / 10 AWG		
Feed-through circuit					
Rated current / Rated cross section		32 A / 4 mm ²	30 A / 10 AWG		
Rated voltage		800 V	300 V		
Impulse withstand voltage		8000 V			
Protection		IP20	NEMA 1		

Separate arrangement	Assembly composed of 1 fuse terminal block in between non fuse terminal blocks	Overload and short-circuit protection	2.5 W
		Exclusive short-circuit protection	4 W
Compound arrangement	Assembly composed of 5 fuse terminal blocks	Overload and short-circuit protection	1.6 W
		Exclusive short-circuit protection	4 W

The connecting capacity data for one Rigid: Solid/Stranded, or one Flexible conductor (when applicable) is a mandatory information required by IEC, UL and CSA standards (Copper conductors). All other data are provided as supplementary information only. For more details, please consult our CB, UL or CSA certificates and technical datasheet available on <http://www.TE.com>

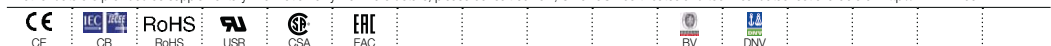

Accessories



Description	Color	Type	Part Number	Pkg qty	Weight (1 pce) g	
1 End stops	Dark grey	BAZH1	1SNK900102R0000	20	24.00	
2 End sections	Dark grey	ES4-D2-SF1	1SNK508911R0000	20	5.00	
3 Jumper bars	Orange	2 poles	JB8-2	1SNK908302R0000	50	2.70
		3 poles	JB8-3	1SNK908303R0000	50	4.10
		4 poles	JB8-4	1SNK908304R0000	50	5.60
		5 poles	JB8-5	1SNK908305R0000	40	7.00
		10 poles	JB8-10	1SNK908310R0000	20	14.20
4 Lateral jumper bars	Grey	PC81-10	1SNA173523R1100	10	5.00	
5 Test adapters	Dark grey	For test plugs DIA 2 mm 0.079 in	TP2	1SNK900203R0000	20	1.70
		For test plugs DIA 4 mm 0.157 in	TP4	1SNK900205R0000	20	2.40
6 Test connectors	Dark grey	5.2 mm 0.205 in spacing	TC5	1SNK900200R0000	10	5.20
		End module, 5.2 mm 0.205 in	TC5-R1	1SNK900201R0000	10	5.20
7 Spacers	Dark grey	ES-TC8	1SNK900104R0000	10	1.40	
8 Assembly rods	Dark grey	2 poles	TGA8	1SNA168672R1100	10	1.00
		3 poles	TGA8	1SNA168673R1200	10	1.50
		4 poles	TGA8	1SNA168674R1300	10	2.00
9 Terminal block markers	White	Blank marker	MG-CPM 13 41791	1SNB041791R0612	1680	0.27
		Blank card	MC812	1SNK160000R0000	22	10.00
			MC812PA	1SNK169999R0000	20	14.00
		Universal wire markers holder	UMH	1SNK900611R0000	10	0.20

Complete list of accessories is indicated in the terminal block datasheet including end stops.

Some accessories such as jumper bars may modify the terminal block's ratings: Complete information available in the accessories section of the catalog.

Technical data valid for copper conductors only.

ZS4-T3 screw clamp terminal blocks

Triple deck with 3 feed-through circuits - 5.2 mm 0.205 in spacing



ZS4-T3

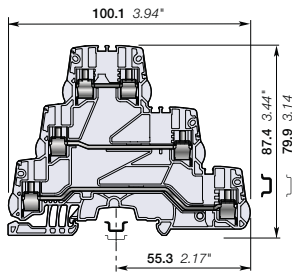

5.2 mm 0.205 in spacing

Description

Save space: 3 independent circuits in just 5.2 mm 0.205 in spacing,

- Fit many applications: space constraints, multiple signals distribution, sensors distribution, thanks to the jumper channels available on each deck.

Ordering details

Description	Color	Type	Part Number	Pkg qty	Weight (1 pce) g
Feed-through 3 feed-through circuits	Grey <input type="checkbox"/>	ZS4-T3	1SNK505212R0000	25	24.40

Main technical data

Connecting capacity		IEC	UL - CSA	Mounting instructions	
1 conductor per clamp	Rigid: Solid/Stranded	0.2 ... 4 mm ²	24 ... 12 AWG	Rail	TH 35-7.5, TH 35-15
	Flexible without ferrule	0.22 ... 4 mm ²		Wire stripping length	10.5 mm 0.413 in
	Flexible with non insulated ferrule	0.22 ... 4 mm ²	24 ... 12 AWG		
	Flexible with insulated ferrule	0.22 ... 2.5 mm ²	24 ... 14 AWG		
	Gauge	A3-B3			
2 conductors per clamp	Rigid: Solid/Stranded	0.2 ... 1.5 mm ²	24 ... 16 AWG	Tool	Flat screwdriver Ø 3.5 mm Ø 0.138 in
	Flexible without ferrule	0.2 ... 1.5 mm ²			
	Flexible with twin ferrule	0.22 ... 1.5 mm ²	24 ... 16 AWG		
Rated current / Rated cross section		32 A / 4 mm ²	20 A / 12 AWG	Torque	0.6 Nm ± 0.1 5.31 lb.in ± 0.885
Rated short-time withstand current (1s)		480 A			
Rated voltage		800 V	300 V		
Impulse withstand voltage		8000 V			
Protection		IP20	NEMA 1		

The connecting capacity data for one Rigid: Solid/Stranded, or one Flexible conductor (when applicable) is a mandatory information required by IEC, UL and CSA standards (Copper conductors). All other data are provided as supplementary information only. For more details, please consult our CB, UL or CSA certificates and technical datasheet available on <http://www.TE.com>

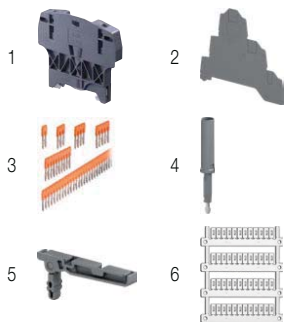
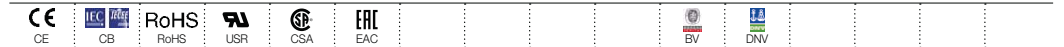

Accessories

Description	Color	Type	Part Number	Pkg qty	Weight (1 pce) g	
1 End stops 10 mm 0.394 in	Dark grey <input checked="" type="checkbox"/>	BAZH1	1SNK900102R0000	20	24.00	
2 End sections 0.8 mm 0.031 in	Dark grey <input checked="" type="checkbox"/>	ES4-T3	1SNK505961R0000	20	4.20	
3 Jumper bars	Orange <input checked="" type="checkbox"/>	2 poles 32 A (IEC)	JB5-2	1SNK905302R0000	50	1.30
		3 poles 32 A (IEC)	JB5-3	1SNK905303R0000	50	2.00
		4 poles 32 A (IEC)	JB5-4	1SNK905304R0000	50	2.70
		5 poles 32 A (IEC)	JB5-5	1SNK905305R0000	50	3.50
		10 poles 32 A (IEC)	JB5-10	1SNK905310R0000	30	7.10
		50 poles 32 A (IEC)	JB5-50	1SNK905350R0000	10	36.00
4 Test adapters	Dark grey <input checked="" type="checkbox"/>	For test plugs DIA 2 mm 0.079 in	TP2	1SNK900203R0000	20	1.70
		For test plugs DIA 4 mm 0.157 in	TP4	1SNK900205R0000	20	2.40
5 Label holders	Dark grey <input checked="" type="checkbox"/>	LH-J	1SNK900606R0000	100	0.73	
6 Terminal block markers	White <input type="checkbox"/>	Blank marker	MG-CPM 13 41790	1SNB041790R0512	1960	0.23
		Blank card	MC512	1SNK140000R0000	22	9.00
			MC512PA	1SNK149999R0000	20	10.00
		Universal wire markers holder	Grey <input type="checkbox"/>	UMH	1SNK900611R0000	10

Complete list of accessories is indicated in the terminal block datasheet including end stops.

Some accessories such as jumper bars may modify the terminal block's ratings: Complete information available in the accessories section of the catalog.

Technical data valid for copper conductors only.

ZS4-T3-R1 screw clamp terminal blocks

Triple deck with 3 feed-through circuits - 6 mm 0.236 in spacing

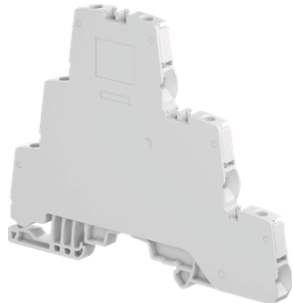

ZS4-T3-R1

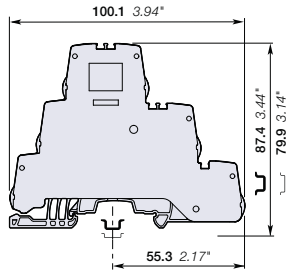

6 mm 0.236 in spacing

Description

Unique triple deck solution combining increased connecting capacity (up to 4 mm² with ferrule) and jumper channel available on each deck,

- Fit many applications: space constraints, multiple signals distribution, sensors distribution,
- Closed terminal block: no end section needed, optimized rigidity.

Ordering details

Description	Color	Type	Part Number	Pkg qty	Weight (1 pce) g
Feed-through Closed block with 3 feed-through circuits	Grey <input type="checkbox"/>	ZS4-T3-R1	1SNK506213R0000	50	28.30

Main technical data

Connecting capacity		IEC	UL - CSA	Mounting instructions	
1 conductor per clamp	Rigid: Solid/Stranded	0.2 ... 4 mm ²	24 ... 10 AWG	Rail	TH 35-7.5, TH 35-15
	Flexible without ferrule	0.22 ... 4 mm ²		Wire stripping length	10.5 mm 0.413 in
	Flexible with non insulated ferrule	0.22 ... 4 mm ²	24 ... 12 AWG		
	Flexible with insulated ferrule	0.22 ... 4 mm ²	24 ... 12 AWG		
	Gauge	A3-B3			
2 conductors per clamp	Rigid: Solid/Stranded	0.2 ... 1.5 mm ²	24 ... 16 AWG	Tool	Flat screwdriver Ø 3.5 mm Ø 0.138 in
	Flexible without ferrule	0.2 ... 1.5 mm ²			
	Flexible with twin ferrule	0.22 ... 1.5 mm ²	24 ... 16 AWG		
Rated current / Rated cross section		32 A / 4 mm ²	30 A / 10 AWG	Torque	0.6 Nm ± 0.1 5.31 lb.in ± 0.885
Rated short-time withstand current (1s)		480 A			
Rated voltage		800 V	300 V		
Impulse withstand voltage		8000 V			
Protection		IP20	NEMA 1		

The connecting capacity data for one Rigid: Solid/Stranded, or one Flexible conductor (when applicable) is a mandatory information required by IEC, UL and CSA standards (Copper conductors). All other data are provided as supplementary information only. For more details, please consult our CB, UL or CSA certificates and technical datasheet available on <http://www.TE.com>

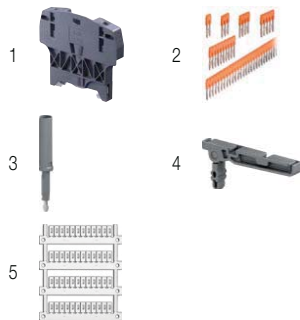

Accessories

Description	Color	Type	Part Number	Pkg qty	Weight (1 pce) g	
1 End stops	Dark grey <input checked="" type="checkbox"/>	BAZH1	1SNK900102R0000	20	24.00	
2 Jumper bars	Orange <input checked="" type="checkbox"/>	2 poles	JB6-2	1SNK906302R0000	50	1.30
		3 poles	JB6-3	1SNK906303R0000	50	2.10
		4 poles	JB6-4	1SNK906304R0000	50	2.90
		5 poles	JB6-5	1SNK906305R0000	50	3.60
		10 poles	JB6-10	1SNK906310R0000	20	7.40
3 Test adapters	Dark grey <input checked="" type="checkbox"/>	For test plugs DIA 2 mm 0.079 in	TP2	1SNK900203R0000	20	1.70
		For test plugs DIA 4 mm 0.157 in	TP4	1SNK900205R0000	20	2.40
4 Label holders	Dark grey <input checked="" type="checkbox"/>	LH-J	1SNK900606R0000	100	0.73	
5 Terminal block markers	White <input checked="" type="checkbox"/>	Blank marker	MG-CPM 13 41791	1SNB041791R0612	1680	0.27
		Blank card	MC512	1SNK140000R0000	22	9.00
			MC512PA	1SNK149999R0000	20	10.00
		Universal wire markers holder	Grey <input type="checkbox"/>	UMH	1SNK900611R0000	10

Complete list of accessories is indicated in the terminal block datasheet including end stops. Some accessories such as jumper bars may modify the terminal block's ratings: Complete information available in the accessories section of the catalog.

Technical data valid for copper conductors only.

ZS4-D-CH-UD screw clamp terminal blocks

Component holder - 5.2 mm 0.205 in spacing

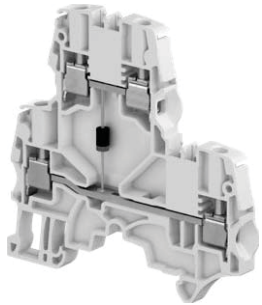

1SNK161141V0014

ZS4-D-CH

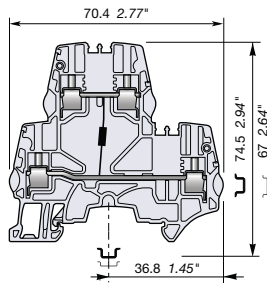

5.2 mm 0.205 in spacing

Description

Protect your circuit with one 1N4007 diode.

Ordering details

Description	Color	Type	Part Number	Pkg qty	Weight (1 pce) g
Component holder Cathode of the blocking diode connected to the lower circuit	Grey <input type="checkbox"/>	ZS4-D-CH-UD	1SNK505214R0000	50	15.30

Main technical data

Connecting capacity		IEC	UL - CSA	Mounting instructions	
1 conductor per clamp	Rigid: Solid/Stranded	0.2 ... 4 mm ²	24 ... 12 AWG	Rail	TH 35-7.5, TH 35-15
	Flexible without ferrule	0.22 ... 4 mm ²		Wire stripping length	10 mm 0.393 in
	Flexible with non insulated ferrule	0.22 ... 4 mm ²	24 ... 12 AWG		
	Flexible with insulated ferrule	0.22 ... 2.5 mm ²	24 ... 14 AWG		
Gauge		A3-B3		Tool	Flat screwdriver Ø 3.5 mm Ø 0.138 in
2 conductors per clamp	Rigid: Solid/Stranded	0.2 ... 1.5 mm ²	24 ... 16 AWG		
	Flexible without ferrule	0.2 ... 1.5 mm ²			
	Flexible with twin ferrule	0.22 ... 1.5 mm ²	24 ... 16 AWG		
Rated current / Rated cross section		29 A / 4 mm ²	20 A / 12 AWG	Torque	0.6 Nm ± 0.1 5.31 lb.in ± 0.885
Rated short-time withstand current (1s)		480 A			
Short Circuit Current Rating (with specific conditions)					
Rated voltage		800 V	300 V		
Impulse withstand voltage					
Protection		IP20	NEMA 1		

The connecting capacity data for one Rigid: Solid/Stranded, or one Flexible conductor (when applicable) is a mandatory information required by IEC, UL and CSA standards (Copper conductors). All other data are provided as supplementary information only. For more details, please consult our CB, UL or CSA certificates and technical datasheet available on <http://www.TE.com>

CE	RoHS	UL US USR CNR	CSA	EAC

Accessories

Description	Color	Type	Part Number	Pkg qty	Weight (1 pce) g	
1 End stops	Dark grey <input checked="" type="checkbox"/>	BAZH1	1SNK900102R0000	20	24.00	
2 End sections	Dark grey <input checked="" type="checkbox"/>	ES4-D2	1SNK505960R0000	20	4.10	
3 Jumper bars	Orange <input checked="" type="checkbox"/>	2 poles	JB5-2	1SNK905302R0000	50	1.30
		3 poles	JB5-3	1SNK905303R0000	50	2.00
		4 poles	JB5-4	1SNK905304R0000	50	2.70
		5 poles	JB5-5	1SNK905305R0000	50	3.50
		10 poles	JB5-10	1SNK905310R0000	30	7.10
4 Test adapters	Dark grey <input checked="" type="checkbox"/>	For test plugs DIA 2 mm 0.079 in	TP2	1SNK900203R0000	20	1.70
		For test plugs DIA 4 mm 0.157 in	TP4	1SNK900205R0000	20	2.40
5 Test connectors	Dark grey <input checked="" type="checkbox"/>	5.2 mm 0.205 in spacing	TC5	1SNK900200R0000	10	5.20
		End module, 5.2 mm 0.205 in	TC5-R1	1SNK900201R0000	10	5.20
6 Shield connectors		SHB	1SNK900602R0000	20	4.90	
7 Label holders	Dark grey <input checked="" type="checkbox"/>	LH-J	1SNK900606R0000	100	0.73	
8 Terminal block markers	White <input type="checkbox"/>	Blank marker	MG-CPM 13 41790	1960	0.23	
		Blank card	MC512	1SNK140000R0000	22	9.00
	Grey <input type="checkbox"/>		MC512PA	1SNK149999R0000	20	10.00
		Universal wire markers holder	UMH	1SNK900611R0000	10	0.20

Complete list of accessories is indicated in the terminal block datasheet including end stops. Some accessories such as jumper bars may modify the terminal block's ratings: Complete information available in the accessories section of the catalog.

Technical data valid for copper conductors only.

ZS4-D-CH-DU screw clamp terminal blocks

Component holder - 5.2 mm 0.205 in spacing

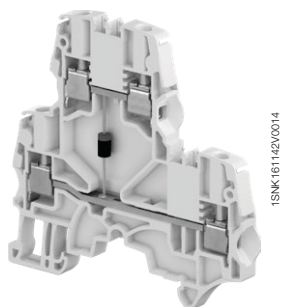

ZS4-D-CH

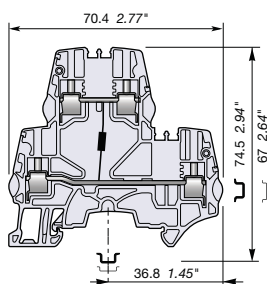

5.2 mm 0.205 in spacing

Description

Protect your circuit with one 1N4007 diode.

Ordering details

Description	Color	Type	Part Number	Pkg qty	Weight (1 pce) g
Component holder Cathode of the blocking diode connected to the upper circuit	Grey <input type="checkbox"/>	ZS4-D-CH-DU	1SNK505215R0000	50	15.30

Main technical data

Connecting capacity		IEC	UL - CSA	Mounting instructions	
1 conductor per clamp	Rigid: Solid/Stranded	0.2 ... 4 mm ²	24 ... 12 AWG	Rail	TH 35-7.5, TH 35-15
	Flexible without ferrule	0.22 ... 4 mm ²		Wire stripping length	10 mm 0.393 in
	Flexible with non insulated ferrule	0.22 ... 4 mm ²	24 ... 12 AWG	Tool	Flat screwdriver Ø 3.5 mm Ø 0.138 in
	Flexible with insulated ferrule	0.22 ... 2.5 mm ²	24 ... 14 AWG		
Gauge		A3-B3		Torque	0.6 Nm ± 0.1 5.31 lb.in ± 0.885
2 conductors per clamp					
Rigid: Solid/Stranded		0.2 ... 1.5 mm ²	24 ... 16 AWG		
Flexible without ferrule		0.2 ... 1.5 mm ²			
Flexible with twin ferrule		0.22 ... 1.5 mm ²	24 ... 16 AWG		
Rated current / Rated cross section		29 A / 4 mm ²	20 A / 12 AWG		
Rated short-time withstand current (1s)		480 A			
Short Circuit Current Rating (with specific conditions)					
Rated voltage		800 V	300 V		
Impulse withstand voltage					
Protection		IP20	NEMA 1		

The connecting capacity data for one Rigid: Solid/Stranded, or one Flexible conductor (when applicable) is a mandatory information required by IEC, UL and CSA standards (Copper conductors). All other data are provided as supplementary information only. For more details, please consult our CB, UL or CSA certificates and technical datasheet available on <http://www.TE.com>

--	--	--	--	--



Accessories

Description	Color	Type	Part Number	Pkg qty	Weight (1 pce) g	
1 End stops	Dark grey <input checked="" type="checkbox"/>	BAZH1	1SNK900102R0000	20	24.00	
2 End sections	Dark grey <input checked="" type="checkbox"/>	ES4-D2	1SNK505960R0000	20	4.10	
3 Jumper bars	Orange <input checked="" type="checkbox"/>	2 poles	JB5-2	1SNK905302R0000	50	1.30
		3 poles	JB5-3	1SNK905303R0000	50	2.00
		4 poles	JB5-4	1SNK905304R0000	50	2.70
		5 poles	JB5-5	1SNK905305R0000	50	3.50
		10 poles	JB5-10	1SNK905310R0000	30	7.10
		50 poles	JB5-50	1SNK905350R0000	10	36.00
4 Test adapters	Dark grey <input checked="" type="checkbox"/>	For test plugs DIA 2 mm 0.079 in	TP2	1SNK900203R0000	20	1.70
		For test plugs DIA 4 mm 0.157 in	TP4	1SNK900205R0000	20	2.40
5 Test connectors	Dark grey <input checked="" type="checkbox"/>	5.2 mm 0.205 in spacing	TC5	1SNK900200R0000	10	5.20
		End module, 5.2 mm 0.205 in	TC5-R1	1SNK900201R0000	10	5.20
			SHB	1SNK900602R0000	20	4.90
6 Shield connectors						
7 Label holders	Dark grey <input checked="" type="checkbox"/>	LH-J	1SNK900606R0000	100	0.73	
8 Terminal block markers	White <input type="checkbox"/>	Blank marker	MG-CPM 13 41790	1SNB041790R0512	1960	0.23
		Blank card	MC512	1SNK140000R0000	22	9.00
			MC512PA	1SNK149999R0000	20	10.00
	Universal wire markers holder	Grey <input type="checkbox"/>	UMH	1SNK900611R0000	10	0.20

Complete list of accessories is indicated in the terminal block datasheet including end stops. Some accessories such as jumper bars may modify the terminal block's ratings. Complete information available in the accessories section of the catalog.

Technical data valid for copper conductors only.

SNK series, terminal blocks

Screw clamp technology - Test & measurement

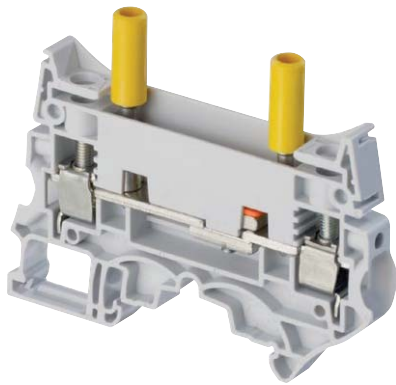

Secure your measurement operations

The new ZS10-ST test & measurement terminal blocks benefit from our long experience in the energy applications and from the SNK features: performances, ergonomics, common accessories and marking.

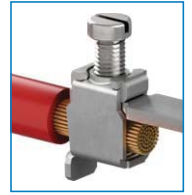

High performances

- 10 mm² 6 AWG
- 6 mm² 10 AWG with ferrule
- 50 A (IEC) 53 A (UL)
- Worldwide certifications



Rely on our smart design

Insulated short circuit bridges:
SC-JB8

Insulated captive test sockets:
AJS9
6 colors
compatible with standard
DIA. 4 mm test plugs
(IEC 60010-031)

Circuit separators: CS
For visual separation between
CT & PT circuits

Protecting cover kits: KCO

New ground terminal block:
ZS10-PE-R1

Lateral jumper bar: PC8
For CT or PT commoning

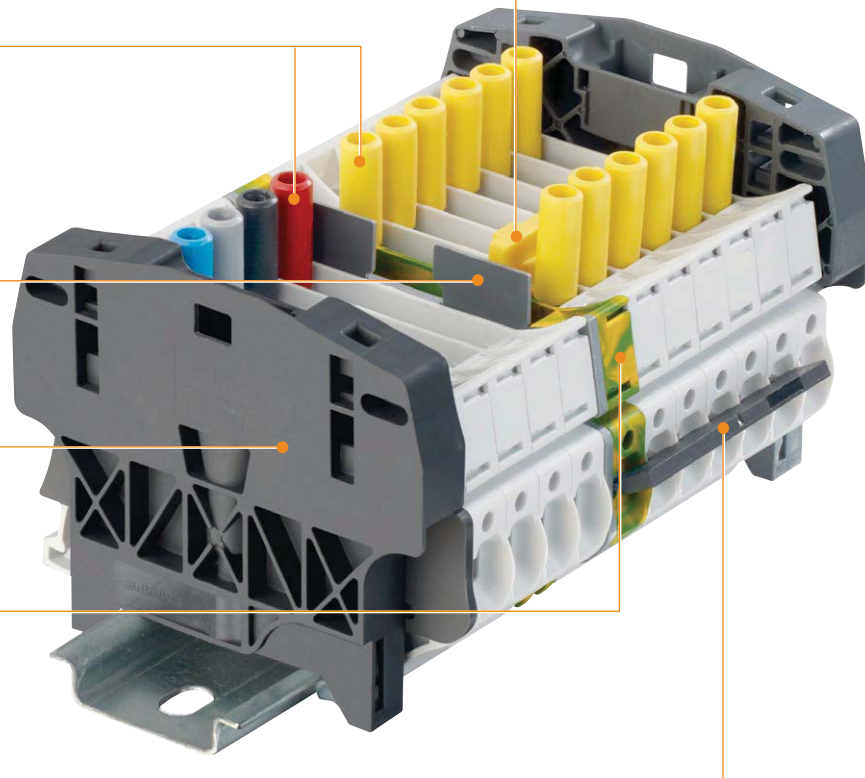

1SNK160057S0201



Assembly with protecting cover



Drilling and centering guide

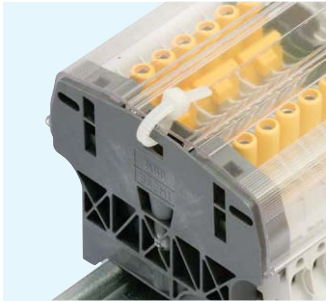

Seal with cable tie

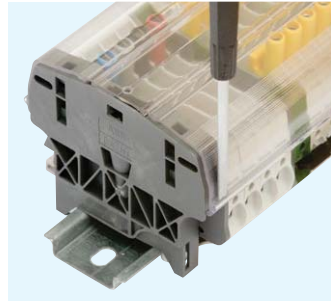

Convenient removal with screwdriver

Guarantee access only to authorized operators

cover can be permanently sealed with a seal or cable tie.

Centering drilling guide for seal or cable tie.

The cover is specially designed to ease its mounting or removal:

- Hook shape on each side for convenient removal with screwdriver

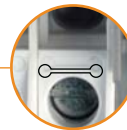
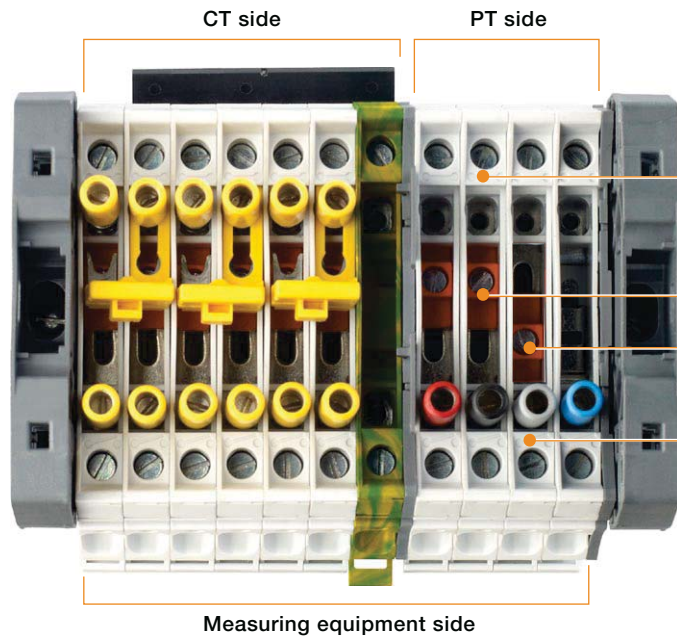

sliding link status: closed

Disconnect sliding link status:

Open and close symbols help to visualize the sliding link position

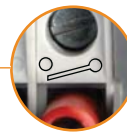

sliding link status: opened



1



2

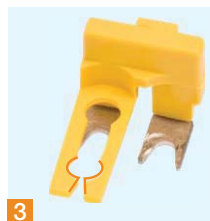

3

Short-circuit CT circuits safely and conveniently

- 1 Fully operated by screwdriver (DIA 3.5 mm)
- 2 Short-circuited position secured thanks to AJS9 test sockets tightening
- 3 Adapted hook shape maintain the bridge on terminal block in the non connected position

TSNK160057S0201

SNK series, terminal blocks

Test & measurement - Typical schematic for measuring devices

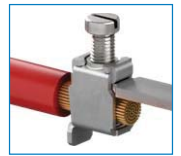

Common point on the transformers

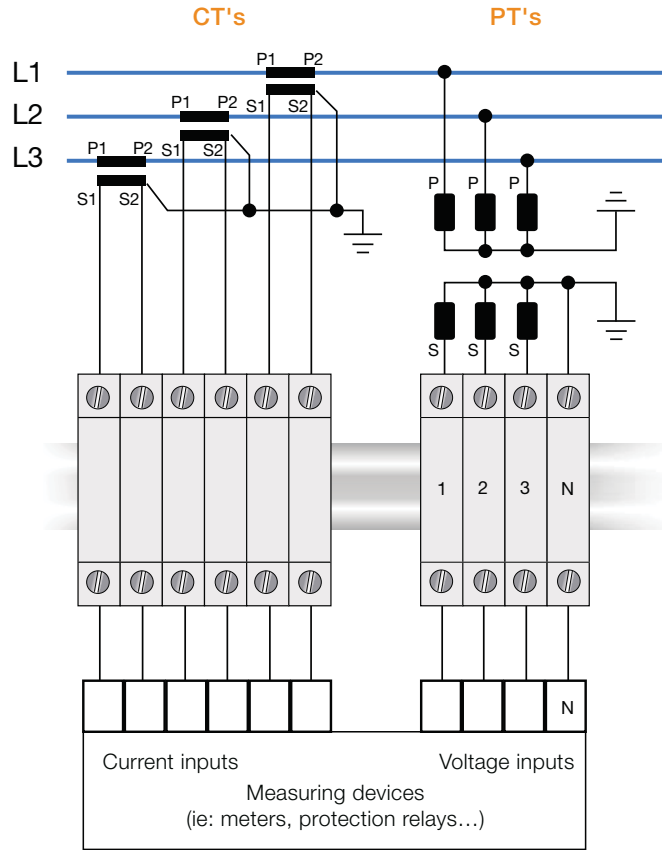

Bill of material optimized

Bill of material with convenient customization (test sockets, feed-through terminals...)

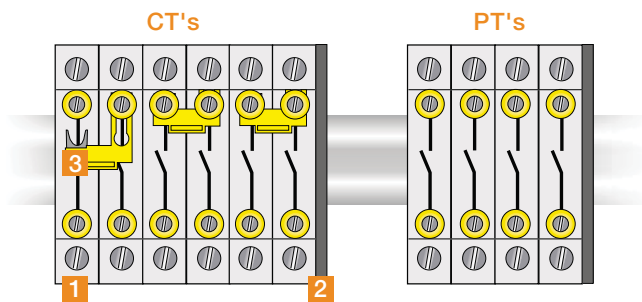

Description	Type	Order code	Qty needed	
			CT's	PT's
1 Terminal block	ZS10-ST-T4	1SNK508311R0000	6	4
2 End section	ES10-ST	1SNK508910R0000	1	1
3 Short-circuit bridges	SC-JB8-2	1SNK900652R0000	3	0

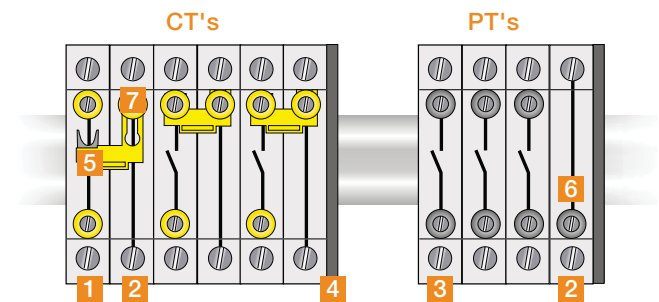

Description	Type	Order code	Qty needed	
			CT's	PT's
1 Terminal block	ZS10-ST-T4	1SNK508311R0000	3	0
2 Terminal block	ZS10-R1	1SNK508011R0000	3	1
3 Terminal block	ZS10-ST-1	1SNK508312R0000	0	3
4 End section	ES10-ST	1SNK508910R0000	1	1
5 Short-circuit bridges	SC-JB8-2	1SNK900652R0000	3	0
6 Test socket	AL4-M3	1SNA206721R0100	0	1
7 Insulated test socket	AJS9	1SNA179726R0200	3	0

1SNK160058S0201

SNK series, terminal blocks

Test & measurement - Typical schematic for measuring devices

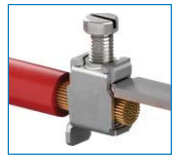

Common point on the terminal block assembly

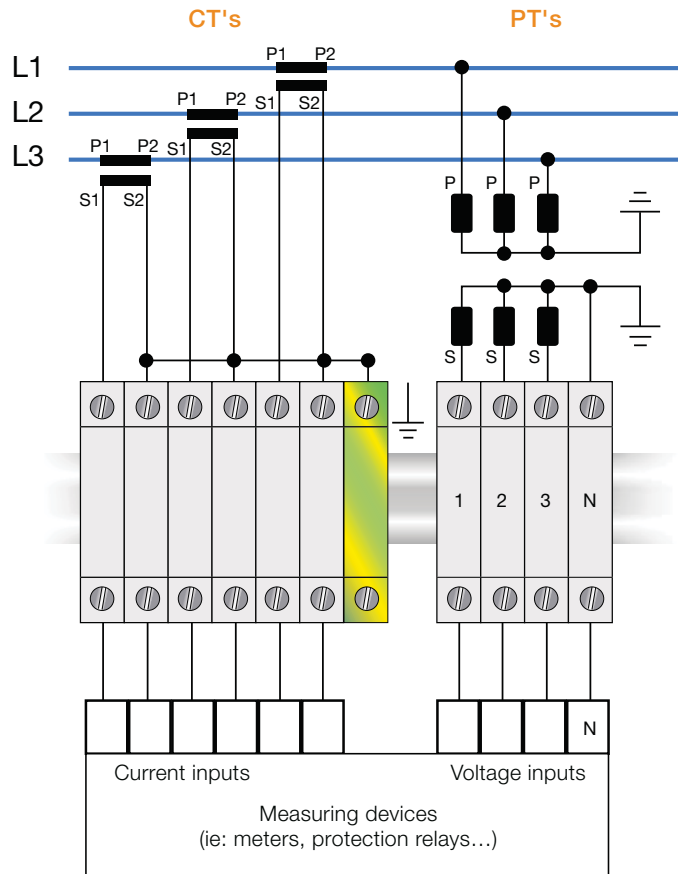

Bill of material optimized

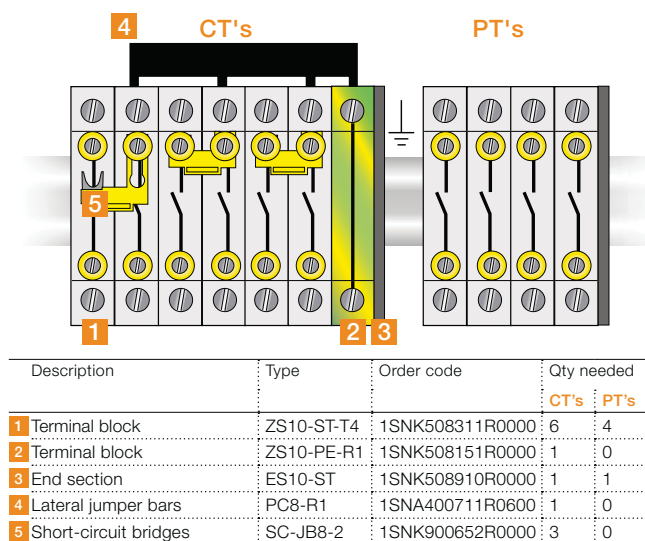

Bill of material with convenient customization (test sockets, feed-through terminals...)

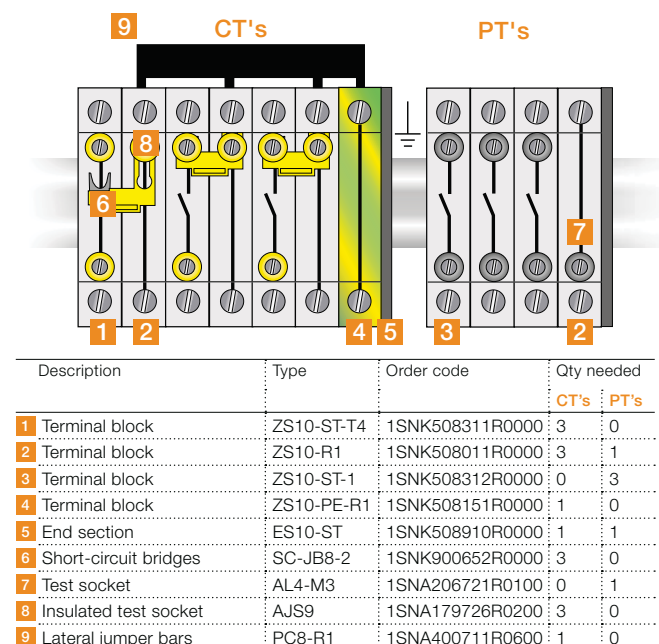

ZS10-ST screw clamp terminal blocks

Test disconnect with sliding link - 8 mm 0.315 in spacing

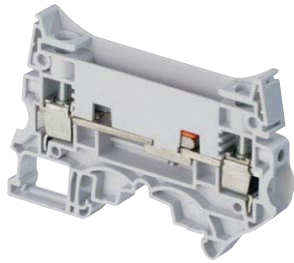

ZS10-ST

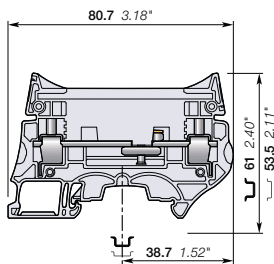

8 mm 0.315 in spacing

Description

- Secure your disconnect operations in control circuits with the robust sliding link operated with a screwdriver,
- Customize ZS10-ST with colored test sockets in order to identify conveniently each phase of the Current Transformer or Potential Transformers secondary circuits,
- Fully compatible with the ZS10-ST-T4 accessories.

Ordering details

Description	Color	Type	Part Number	Pkg qty	Weight (1 pce)
Disconnect	Grey	ZS10-ST	1SNK508310R0000	25	24.80

Main technical data

Connecting capacity		IEC	UL - CSA	Mounting instructions	
1 conductor per clamp	Rigid: Solid/Stranded	0.5 ... 10 mm ²	24 ... 6 AWG	Rail	TH 35-7.5, TH 35-15
	Flexible without ferrule	0.5 ... 10 mm ²		Wire stripping length	13 mm 0.512 in
	Flexible with non insulated ferrule	0.5 ... 10 mm ²	24 ... 8 AWG	Screw clamp Tool	Flat screwdriver Ø 3.5 mm Ø 0.138 in
	Flexible with insulated ferrule	0.5 ... 6 mm ²	24 ... 10 AWG		
Gauge		A5-B5		Torque	1.3 Nm ± 0.3 11.5 lb.in ± 2.65
2 conductors per clamp	Rigid: Solid/Stranded	0.5 ... 4 mm ²	20 ... 12 AWG	Disconnect device Tool	Flat screwdriver Ø 3.5 mm Ø 0.138
	Flexible without ferrule	0.5 ... 4 mm ²			
	Flexible with twin ferrule	0.5 ... 4 mm ²	20 ... 12 AWG	Torque	0.4 Nm ... 0.6 Nm 3.5 lb.in ... 5.3 lb.in
Rated current / Rated cross section		50 A / 10 mm ²	53 A / 6 AWG		
Rated short-time withstand current (1s)		1200 A			
Rated voltage		630 V	300 V		
Impulse withstand voltage		8000 V			
Protection		IP20	NEMA 1		

The connecting capacity data for one Rigid: Solid/Stranded, or one Flexible conductor (when applicable) is a mandatory information required by IEC, UL and CSA standards (Copper conductors). All other data are provided as supplementary information only. For more details, please consult our CB, UL or CSA certificates and technical datasheet available on <http://www.TE.com>

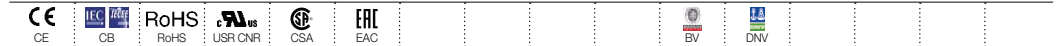

Accessories

Description	Color	Type	Part Number	Pkg qty	Weight (1 pce)	
1 End stops	Dark grey	BAM4	1SNK900001R0000	50	14.00	
2 End sections	Dark grey	ES10-ST	1SNK508910R0000	20	3.5	
3 Jumper bars	Orange	2 poles 50 A (IEC)	JB8-2-R1	1SNK908902R0000	10	7.6
		3 poles 50 A (IEC)	JB8-3-R1	1SNK908903R0000	10	11.6
		4 poles 50 A (IEC)	JB8-4-R1	1SNK908904R0000	10	15.5
		5 poles 50 A (IEC)	JB8-5-R1	1SNK908905R0000	10	19.4
		10 poles 50 A (IEC)	JB8-10-R1	1SNK908910R0000	10	39.00
4 Circuit separators	Dark grey	CS-R3	1SNK900107R0000	20	6.40	
5 Test sockets	Yellow	AJS9	1SNA179726R0200	25	3.60	
	Black	AJS9-BK	1SNA206680R1500	25	3.60	
	Green	AJS9-GN	1SNA206681R0200	25	3.60	
	Grey	AJS9-GR	1SNA206682R0300	25	3.60	
	Blue	AJS9-BL	1SNA206683R0400	25	3.60	
	Red	AJS9-RD	1SNA206720R1400	25	3.60	
	White	AJS9-WH	1SNA206765R0000	25	3.60	
	Purple	AJS9-PR	1SNA206772R0000	25	3.60	
	Brown	AJS9-BR	1SNA206782R0000	25	3.60	
			AL4-M3	1SNA206721R0100	50	1.10
6 Terminal block markers	White	MG-CPM 13 41791	1SNB041791R0612	1680	0.27	
		MC812	1SNK160000R0000	22	10.00	
		MC812PA	1SNK169999R0000	20	14.00	
		Universal wire markers holder	Grey	UMH	1SNK900611R0000	10

Complete list of accessories is indicated in the terminal block datasheet including end stops. Some accessories such as jumper bars may modify the terminal block's ratings: Complete information available in the accessories section of the catalog.

Screw clamp terminal blocks

Description	Color	Type	Part Number	Pkg qty	Weight (1 pce)
Feed-through	Grey	ZS10-R1	1SNK508011R0000	25	20.90
Ground	Green-yellow	ZS10-PE-R1	1SNK508151R0000	25	28.40



ZS10-R1



ZS10-PE-R1

Technical data valid for copper conductors only.

ZS10-ST-1 screw clamp terminal blocks

Test disconnect with sliding link for Potential Transformer circuits - 8 mm 0.315 in spacing



10 mm²
6 AWG

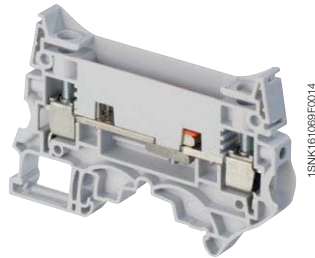

1SNK161069F0014

ZS10-ST-1

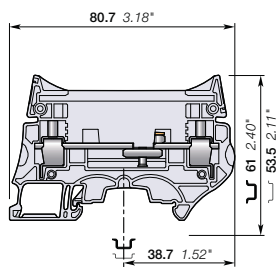

8 mm 0.315 in spacing

Description

Test terminal blocks especially designed for Potential Transformers circuits:

- low profile voltage measurement thanks to the two compact built-in test sockets compatible with DIA 4 mm 0.157 in test plugs,
- Installed with our aligned feed-through and ground terminal blocks, you benefit of a complete and compact solution for your PT circuits.

Ordering details

Description	Color	Type	Part Number	Pkg qty	Weight (1 pce) g
Disconnect With 2 test sockets DIA 4 mm 0.157 in	Grey <input type="checkbox"/>	ZS10-ST-1	1SNK508312R0000	25	27.00

Main technical data

Connecting capacity	IEC	UL - CSA	Mounting instructions		
1 conductor per clamp	Rigid: Solid/Stranded	0.5 ... 10 mm ²	24 ... 6 AWG	Rail	TH 35-7.5, TH 35-15
	Flexible without ferrule	0.5 ... 10 mm ²	24 ... 6 AWG	Wire stripping length	13 mm 0.512 in
	Flexible with non insulated ferrule	0.5 ... 10 mm ²	24 ... 8 AWG		Screw clamp Tool
	Flexible with insulated ferrule	0.5 ... 6 mm ²	24 ... 10 AWG	Torque	
Gauge		A5-B5		Disconnect device Tool	Flat screwdriver Ø 3.5 mm Ø 0.138
2 conductors per clamp	Rigid: Solid/Stranded	0.5 ... 4 mm ²	20 ... 12 AWG		Torque
	Flexible without ferrule	0.5 ... 4 mm ²	20 ... 12 AWG		
Flexible with twin ferrule		0.5 ... 4 mm ²	20 ... 12 AWG		
Rated current / Rated cross section		50 A / 10 mm ²	53 A / 6 AWG		
Rated short-time withstand current (1s)		1200 A			
Rated voltage		630 V	300 V		
Impulse withstand voltage		8000 V			
Protection		IP10	NEMA 1		

The connecting capacity data for one Rigid: Solid/Stranded, or one Flexible conductor (when applicable) is a mandatory information required by IEC, UL and CSA standards (Copper conductors). All other data are provided as supplementary information only. For more details, please consult our CB, UL or CSA certificates and technical datasheet available on <http://www.TE.com>

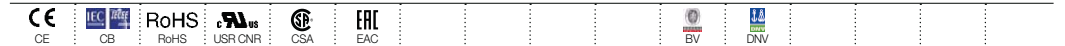

Accessories

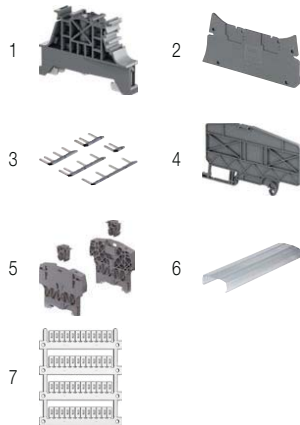

Description	Color	Type	Part Number	Pkg qty	Weight (1 pce) g
1 End stops 10 mm 0.394 in	Dark grey <input type="checkbox"/>	BAM4	1SNK900001R0000	50	14.00
2 End sections 2 mm 0.079 in	Dark grey <input type="checkbox"/>	ES10-ST	1SNK508910R0000	20	3.5
3 Lateral jumper bars 10 poles	Black <input type="checkbox"/>	PC8-10	1SNA163313R2400	10	14.00
		PC8-R1	1SNA400711R0600	10	6.60
		PC8-R2	1SNA400712R0700	10	7.80
		PC8-R3	1SNA400713R0000	10	9.00
		PC8-R4	1SNA400724R0300	10	4.50
		PC8-R5	1SNA400842R0000	10	6.60
		PC8-R6	1SNA400843R0000	10	6.60
		PC8-R7	1SNA400849R0000	10	6.60
PC8-R8	1SNA400850R0000	10	7.80		
4 Circuit separators 3 mm 0.118 in	Dark grey <input type="checkbox"/>	CS-R3	1SNK900107R0000	20	6.40
5 Protecting cover kits	Dark grey <input type="checkbox"/>	KCO	1SNK900624R0000	1	47.80
6 Protecting covers 1 m 39.4 in length	Transparent <input checked="" type="checkbox"/>	CO	1SNK900604R0000	1	300.00
7 Terminal block markers	White <input type="checkbox"/>	MG-CPM 13 41791	1SNB041791R0612	1680	0.27
		MC812	1SNK160000R0000	22	10.00
		MC812PA	1SNK169999R0000	20	14.00
Universal wire markers holder	Grey <input type="checkbox"/>	UMH	1SNK900611R0000	10	0.20

Complete list of accessories is indicated in the terminal block datasheet including end stops.

Some accessories such as jumper bars may modify the terminal block's ratings: Complete information available in the accessories section of the catalog.

Screw clamp terminal blocks

Description	Color	Type	Part Number	Pkg qty	Weight (1 pce) g
Feed-through Profile aligned with ZS10-ST...	Grey <input type="checkbox"/>	ZS10-R1	1SNK508011R0000	25	20.90
Ground Profile aligned with ZS10-ST...	Green-yellow <input type="checkbox"/>	ZS10-PE-R1	1SNK508151R0000	25	28.40



ZS10-R1



ZS10-PE-R1

Technical data valid for copper conductors only.

ZS10-ST-T4 screw clamp terminal blocks

Test disconnect with sliding link for Current Transformer circuits - 8 mm 0.315 in spacing

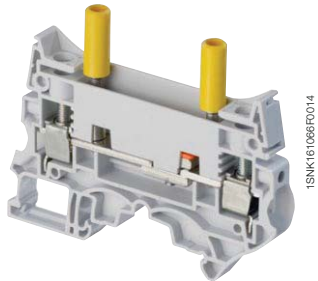

ZS10-ST-T4

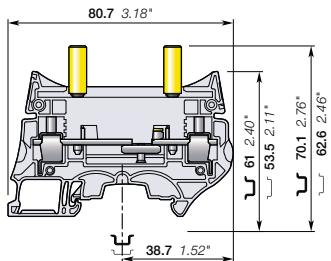

8 mm 0.315 in spacing

Description

Test terminal blocks especially designed for Current Transformers circuits:

- easy and safe current measurement thanks to the two insulated built-in test sockets compatible with IP20 DIA 4 mm 0.157 in test plugs (per IEC60101-031),
- convenient short-circuit operations with the SC-JB insulated sliding bridges.

Ordering details

Description	Color	Type	Part Number	Pkg qty	Weight (1 pce) g
Disconnect With two yellow test sockets DIA 4 mm 0.157 in	Grey <input type="checkbox"/>	ZS10-ST-T4	1SNK508311R0000	25	31.90

Main technical data

Connecting capacity		IEC	UL - CSA	Mounting instructions	
1 conductor per clamp	Rigid: Solid/Stranded	0.5 ... 10 mm ²	24 ... 6 AWG	Rail	TH 35-7.5, TH 35-15
	Flexible without ferrule	0.5 ... 10 mm ²	24 ... 8 AWG	Wire stripping length	13 mm 0.512 in
	Flexible with non insulated ferrule	0.5 ... 10 mm ²	24 ... 8 AWG	Screw clamp Tool	Flat screwdriver Ø 3.5 mm 0.138 in
	Flexible with insulated ferrule	0.5 ... 6 mm ²	24 ... 10 AWG		
Gauge		A5-B5		Torque	1.3 Nm ± 0.3 11.5 lb.in ± 2.65
2 conductors per clamp	Rigid: Solid/Stranded	0.5 ... 4 mm ²	20 ... 12 AWG	Disconnect device Tool	Flat screwdriver Ø 3.5 mm 0.138
	Flexible without ferrule	0.5 ... 4 mm ²	20 ... 12 AWG		
	Flexible with twin ferrule	0.5 ... 4 mm ²	20 ... 12 AWG		
Rated current / Rated cross section		50 A / 10 mm ²	53 A / 6 AWG	Torque	0.4 Nm ... 0.6 Nm 3.5 lb.in ... 5.3 lb.in
Rated short-time withstand current (1s)		1200 A			
Rated voltage		630 V	300 V	Test socket Tool	Flat screwdriver Ø 3.5 mm 0.138
Impulse withstand voltage		8000 V			
Protection		IP20	NEMA 1	Torque	0.4 Nm ... 0.6 Nm 3.5 lb.in ... 5.3 lb.in

The connecting capacity data for one Rigid: Solid/Stranded, or one Flexible conductor (when applicable) is a mandatory information required by IEC, UL and CSA standards (Copper conductors). All other data are provided as supplementary information only. For more details, please consult our CB, UL or CSA certificates and technical datasheet available on <http://www.TE.com>

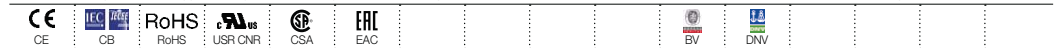

Accessories

Description	Color	Type	Part Number	Pkg qty	Weight (1 pce) g	
1 End stops 10 mm 0.394 in	Dark grey <input type="checkbox"/>	BAM4	1SNK900001R0000	50	14.00	
2 End sections 2 mm 0.079 in	Dark grey <input type="checkbox"/>	ES10-ST	1SNK508910R0000	20	3.5	
3 Lateral jumper bars	Black <input type="checkbox"/>	10 poles	PC8-10	1SNA163313R2400	10	14.00
		4/6 poles	PC8-R1	1SNA400711R0600	10	6.60
		4/8 poles	PC8-R2	1SNA400712R0700	10	7.80
		4/10 poles	PC8-R3	1SNA400713R0000	10	9.00
		3/4 poles	PC8-R4	1SNA400724R0300	10	4.50
		4/7 poles	PC8-R5	1SNA400842R0000	10	6.60
		2/3 poles	PC8-R6	1SNA400843R0000	10	6.60
		4/6 poles	PC8-R7	1SNA400849R0000	10	6.60
4/8 poles	PC8-R8	1SNA400850R0000	10	7.80		
4 Circuit separators 3 mm 0.118 in	Dark grey <input type="checkbox"/>	CS-R3	1SNK900107R0000	20	6.40	
5 Protecting cover kits	Dark grey <input type="checkbox"/>	KCO	1SNK900624R0000	1	47.80	
6 Protecting covers 1 m 39.4 in length	Transparent <input type="checkbox"/>	CO	1SNK900604R0000	1	300.00	
7 Short circuit bridges	Yellow <input type="checkbox"/>	2 poles	SC-JB8-2	1SNK900652R0000	25	2.00
		3 poles	SC-JB8-3	1SNK900653R0000	25	3.4
		4 poles	SC-JB8-4	1SNK900654R0000	25	4.7
8 Terminal block markers	White <input type="checkbox"/>	Blank marker	MG-CPM 13 41791	1SNB041791R0612	1680	0.27
		Blank card	MC812	1SNK160000R0000	22	10.00
			MC812PA	1SNK169999R0000	20	14.00
		Universal wire markers holder	Grey <input type="checkbox"/>	UMH	1SNK900611R0000	10

Complete list of accessories is indicated in the terminal block datasheet including end stops.

Some accessories such as jumper bars may modify the terminal block's ratings: Complete information available in the accessories section of the catalog.

Screw clamp terminal blocks

Description	Color	Type	Part Number	Pkg qty	Weight (1 pce) g
Feed-through Profile aligned with ZS10-ST...	Grey <input type="checkbox"/>	ZS10-R1	1SNK508011R0000	25	20.90
Ground Profile aligned with ZS10-ST...	Green-yellow <input type="checkbox"/>	ZS10-PE-R1	1SNK508151R0000	25	28.40



ZS10-R1



ZS10-PE-R1

Technical data valid for copper conductors only.

ZS10-R1 screw clamp terminal blocks

Feed-through - 8 mm 0.315 in spacing



ZS10-R1

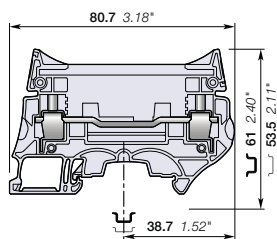

8 mm 0.315 in spacing

Description

- With the same profile as the ZS10-ST..., the feed-through ZS10-R1 allows you to fully implement the electrical drawing of your CT or PT circuits,
- Fully compatible with the ZS10-ST... accessories.

Ordering details

Description	Color	Type	Part Number	Pkg qty	Weight (1 pce) g
Feed-through Profile aligned with ZS10-ST..	Grey <input type="checkbox"/>	ZS10-R1	1SNK508011R0000	25	20.90

Main technical data

Connecting capacity		IEC	UL - CSA	Mounting instructions	
1 conductor per clamp	Rigid: Solid/Stranded	0.5 ... 10 mm ²	24 ... 6 AWG	Rail	TH 35-7.5, TH 35-15
	Flexible without ferrule	0.5 ... 10 mm ²		Wire stripping length	13 mm 0.512 in
	Flexible with non insulated ferrule	0.5 ... 10 mm ²	24 ... 8 AWG		
	Flexible with insulated ferrule	0.5 ... 6 mm ²	24 ... 10 AWG		
Gauge		A5-B5		Tool	Flat screwdriver Ø 3.5 mm Ø 0.138 in
2 conductors per clamp	Rigid: Solid/Stranded	0.5 ... 4 mm ²	20 ... 12 AWG		
	Flexible without ferrule	0.5 ... 4 mm ²	20 ... 12 AWG		
Flexible with twin ferrule		0.5 ... 4 mm ²	20 ... 12 AWG	Torque	1.3 Nm ± 0.3 11.5 lb.in ± 2.65
Rated current / Rated cross section		57 A / 10 mm ²	62 A / 6 AWG		
Rated short-time withstand current (1s)		1200 A			
Short Circuit Current Rating (with specific conditions)					
Rated voltage		630 V	300 V		
Impulse withstand voltage		8000 V			
Protection		IP20	NEMA 1		

The connecting capacity data for one Rigid: Solid/Stranded, or one Flexible conductor (when applicable) is a mandatory information required by IEC, UL and CSA standards (Copper conductors). All other data are provided as supplementary information only. For more details, please consult our CB, UL or CSA certificates and technical datasheet available on <http://www.TE.com>

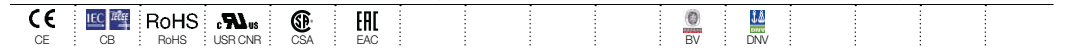

Accessories

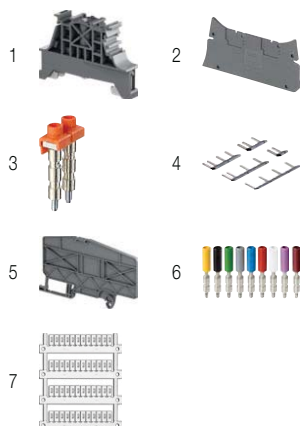

Description	Color	Type	Part Number	Pkg qty	Weight (1 pce) g	
1 End stops 10 mm 0.394 in	Dark grey <input type="checkbox"/>	BAM4	1SNK90001R0000	50	14.00	
2 End sections 2 mm 0.079 in	Dark grey <input type="checkbox"/>	ES10-ST	1SNK508910R0000	20	3.5	
3 Jumper bars	Orange <input type="checkbox"/>	2 poles 50 A (IEC)	JB8-2-R1	1SNK908902R0000	10	7.6
		3 poles 50 A (IEC)	JB8-3-R1	1SNK908903R0000	10	11.6
		4 poles 50 A (IEC)	JB8-4-R1	1SNK908904R0000	10	15.5
		5 poles 50 A (IEC)	JB8-5-R1	1SNK908905R0000	10	19.4
		10 poles 50 A (IEC)	JB8-10-R1	1SNK908910R0000	10	39.00
4 Lateral jumper bars	Black <input type="checkbox"/>	4/7 poles	PC8-R5	1SNA400842R0000	10	6.60
		2/3 poles	PC8-R6	1SNA400843R0000	10	6.60
		4/6 poles	PC8-R7	1SNA400849R0000	10	6.60
		4/8 poles	PC8-R8	1SNA400850R0000	10	7.80
5 Circuit separators 3 mm 0.118 in	Dark grey <input type="checkbox"/>	CS-R3	1SNK900107R0000	20	6.40	
6 Test sockets Test sockets DIA 4 mm 0.157 in	Yellow <input type="checkbox"/>	AJS9	1SNA179726R0200	25	3.60	
7 Terminal block markers	White <input type="checkbox"/>	Blank marker	MG-CPM 13 41791	1SNB041791R0612	1680	0.27
		Blank card	MC812	1SNK160000R0000	22	10.00
		Blank card	MC812PA	1SNK169999R0000	20	14.00
Universal wire markers holder	Grey <input type="checkbox"/>	UMH	1SNK900611R0000	10	0.20	

Complete list of accessories is indicated in the terminal block datasheet including end stops. Some accessories such as jumper bars may modify the terminal block's ratings: Complete information available in the accessories section of the catalog.

Technical data valid for copper conductors only.

ZS10-PE-R1 screw clamp terminal blocks

Ground - 8 mm 0.315 in spacing



ZS10-PE-R1

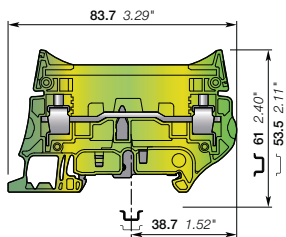

8 mm 0.315 in spacing

Description

- With the same profile as the ZS10-ST..., the ground ZS10-PE-R1 allows you to fully implement the electrical drawing of your CT or PT circuits,
- Fully compatible with the ZS10-ST... accessories,
- Short-circuit performances above the requirements of IEC 60947-7-2 terminal block standard,
- Secured snap on or remove from the rail.

Ordering details

Description	Color	Type	Part Number	Pkg qty	Weight (1 pce) g
Ground Profile aligned with ZS10-ST...	Green-yellow	ZS10-PE-R1	1SNK508151R0000	25	28.40

Main technical data

Connecting capacity	IEC	UL - CSA
1 conductor per clamp	Rigid: Solid/Stranded	0.5 ... 10 mm ²
	Flexible without ferrule	0.5 ... 10 mm ²
	Flexible with non insulated ferrule	0.5 ... 10 mm ²
	Flexible with insulated ferrule	0.5 ... 6 mm ²
	Gauge	A5-B5
Rated cross section	10 mm ²	6 AWG
Rated short-time withstand current (1s)	1200 A	1596 A
Protection	IP20	NEMA 1

Mounting instructions

Rail		TH 35-7.5, TH 35-15
Wire stripping length		13 mm 0.512 in
Tool		Flat screwdriver Ø 3.5 mm Ø 0.138 in
Torque		1.3 Nm ± 0.3 11.5 lb.in ± 2.65

The connecting capacity data for one Rigid: Solid/Stranded, or one Flexible conductor (when applicable) is a mandatory information required by IEC, UL and CSA standards (Copper conductors). All other data are provided as supplementary information only. For more details, please consult our CB, UL or CSA certificates and technical datasheet available on <http://www.TE.com>

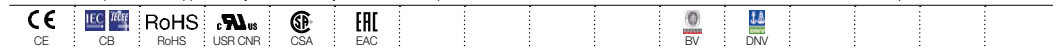

Accessories

Description	Color	Type	Part Number	Pkg qty	Weight (1 pce) g	
1 End stops	Dark grey	BAM4	1SNK900001R0000	50	14.00	
2 End sections	Dark grey	ES10-ST	1SNK508910R0000	20	3.5	
3 Jumper bars	Orange	2 poles	JB8-2-R1	1SNK908902R0000	10	7.6
		3 poles	JB8-3-R1	1SNK908903R0000	10	11.6
		4 poles	JB8-4-R1	1SNK908904R0000	10	15.5
		5 poles	JB8-5-R1	1SNK908905R0000	10	19.4
		10 poles	JB8-10-R1	1SNK908910R0000	10	39.00
4 Lateral jumper bars	Black	4/7 poles	PC8-R5	1SNA400842R0000	10	6.60
		2/3 poles	PC8-R6	1SNA400843R0000	10	6.60
		4/6 poles	PC8-R7	1SNA400849R0000	10	6.60
		4/8 poles	PC8-R8	1SNA400850R0000	10	7.80
5 Circuit separators	Dark grey	CS-R3	1SNK900107R0000	20	6.40	
6 Test sockets	Yellow	AJS9	1SNA179726R0200	25	3.60	
7 Terminal block markers	White	MG-CPM 13 41791	1SNB041791R0612	1680	0.27	
		MC812	1SNK160000R0000	22	10.00	
		MC812PA	1SNK169999R0000	20	14.00	
	Grey	UMH	1SNK900611R0000	10	0.20	

Complete list of accessories is indicated in the terminal block datasheet including end stops.

Some accessories such as jumper bars may modify the terminal block's ratings: Complete information available in the accessories section of the catalog.

Technical data valid for copper conductors only.



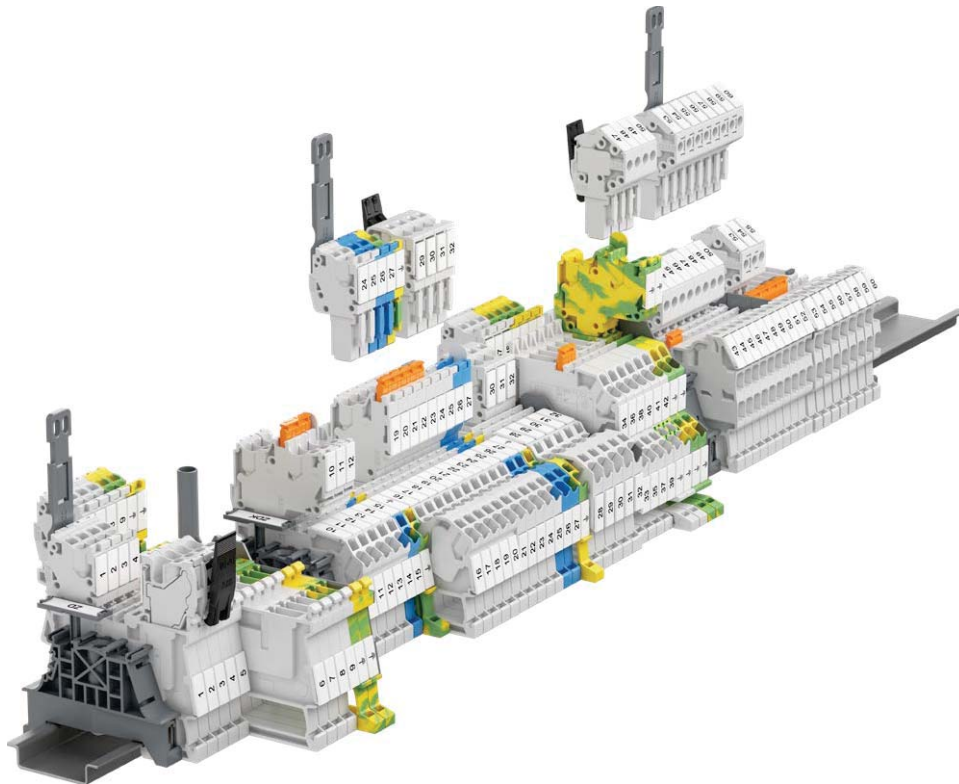

SNK series, terminal blocks

Pluggable technology

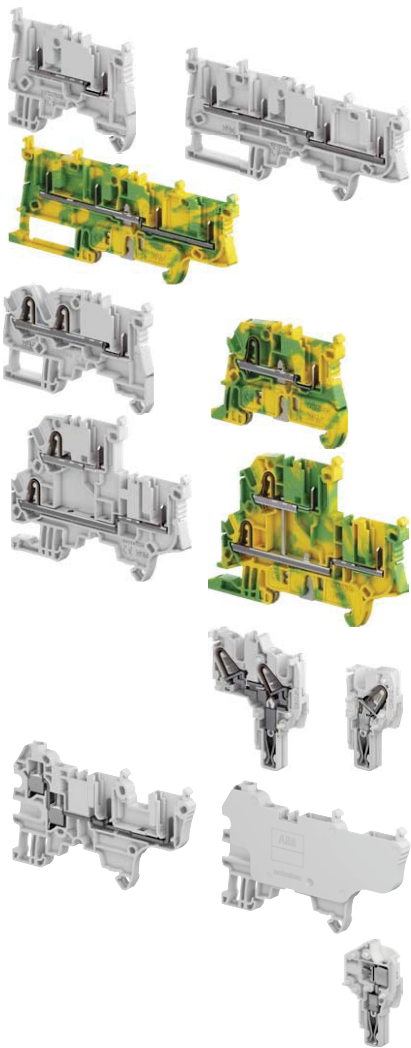

Technologies presentation	162		
Overview	168		
PI-Spring Pluggable			
Pluggable Pluggable			
2.5 mm ² / 12 AWG	Feed-through	ZD2.5-11	172
		ZD2.5-22	173
	Ground	ZD2.5-22-PE	174
PI-Spring Pluggable			
2.5 mm ² / 12 AWG	Feed-through	ZDK2.5-11	175
		ZDK2.5-21	176
		ZDK2.5-22	177
4 mm ² / 10 AWG	Feed-through	ZDK4-22	178
2.5 mm ² / 12 AWG	Ground	ZDK2.5-11-PE	179
		ZDK2.5-22-PE	180
	Double deck	ZDK2.5-D2	181
		ZDK2.5-D1	182
		ZDK2.5-D2-PE	183
		ZDK2.5-D1-PE	184
PI-Spring female plugs		CDK2.5	185
		CDK2.5-J	186
		CDK2.5-2P-J	187
		CDK4	188
Screw clamp Pluggable			
4 mm ² / 10 AWG	Feed-through	ZDS4-22	190
		ZDS4-22-R1	192
Screw clamp female plugs		CDS4	191
		CDS4-R1	193

Pluggable technology - SNK series, terminal blocks

Features and benefits

The SNK series pluggable terminal blocks combine the benefits of our smart connections with the flexibility of the pluggable function.

PI-Spring Pluggable



PI-Spring Pluggable



Pluggable Pluggable

Screw clamp Pluggable

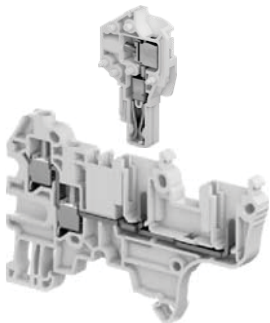

Speed up your projects

Modularity brings assembly flexibility

Pluggable technology brings modularity into the electrical installation allowing the combination of sub-assemblies and prewired harnesses that facilitate and considerably accelerate assembly test and factory commissioning.

Better project identification

- Circuit identification is improved thanks to the 20% larger marking area
- Pre-mark by hand or with label on our flat marking surface and start immediately the wiring, before the final markers mounting
- Spare markers re-printing in case of modifications.

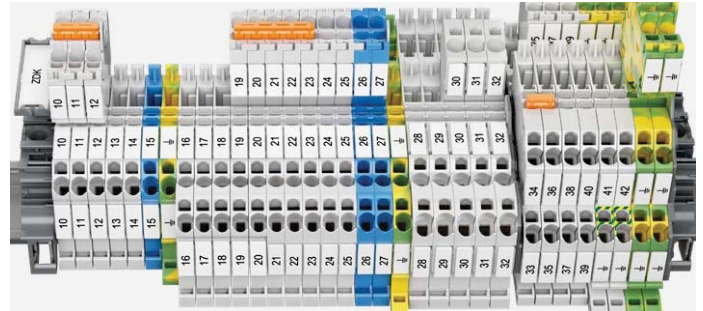

Clear circuit identification

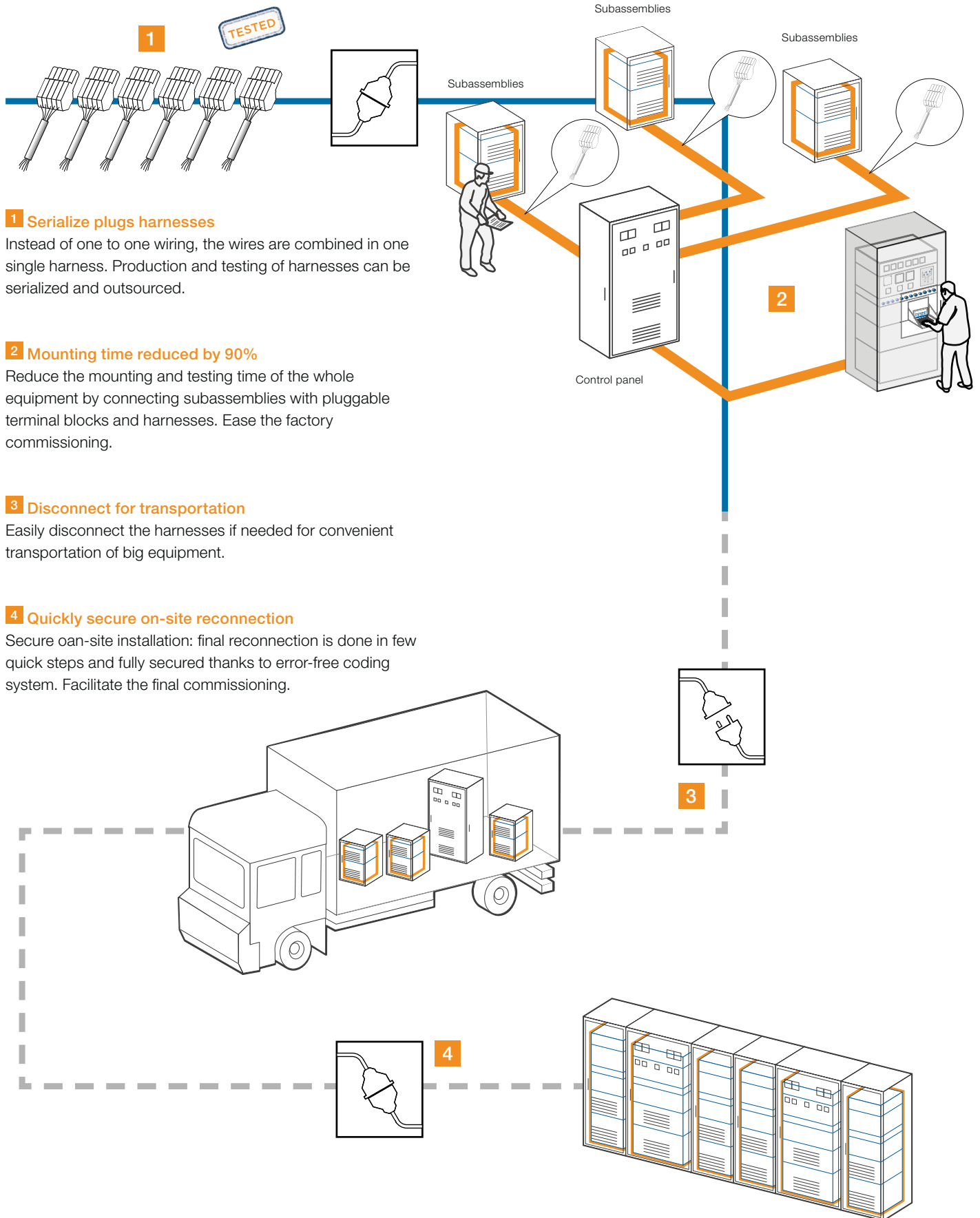

Pluggable technology - SNK series, terminal blocks

Features and benefits

Easy to install

Smart design facilitating assembly process

Mounting, wiring, testing... made easy.

Create your own assemblies without tooling:

- Easily snap together multiple plugs
- Eliminate stock of pre-configured plugs.

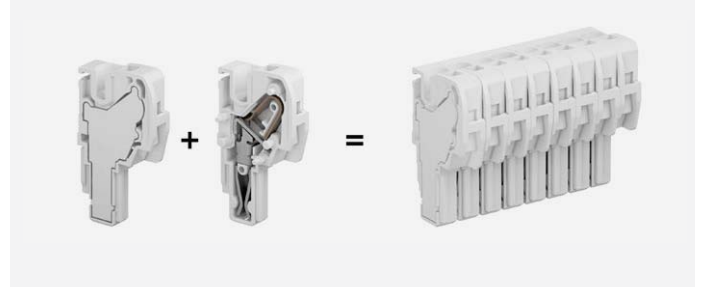

Only two plug variants are required to compose harnesses up to 15 poles

Some plugs feature a jumper channel and/or 2 connections that ease the signal distribution or wiring daisy chaining of subassemblies.

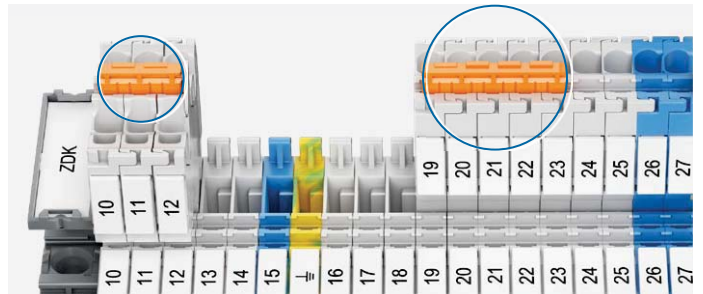

Easy signal distribution on plugs

Safety and protection

Eliminate connection errors with coding pegs:

- Simply insert the pegs to create a coding sequence.

Secure your wiring against accidental tearing:

- Automatic locking function
- Lock safely 2 to 8 plugs with only one locking device
- Cable clamp secures the wires onto the plug when pulling the plug assembly.



Convenient coding pegs

Cable clamp & locking device

SNK series, terminal blocks

Features and benefits

Faster accessories mounting

Save up to 70% mounting time thanks to:

- Screwless jumpers, component plugs, test devices, end stops and snap-in ground terminal blocks.

Closed jumper location allows great stiffness of the terminal block, avoid deflection while tightening and optimal jumper guiding.

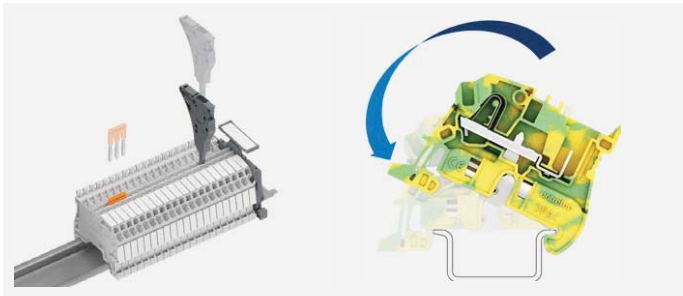

Screwless accessories

Snap-in ground terminal blocks

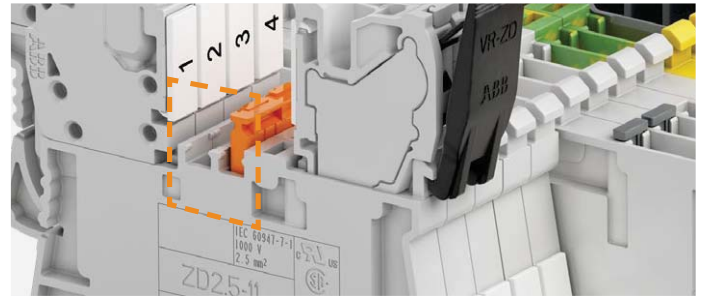

Closed jumper location for stiffness

Smart accessories

Flexible test solutions from individual insulated test adapter to test connectors for complete assemblies testing.

- Direct plug-in into jumpers channels
- 5, 6, 8 mm spacing, mixing various spacing is possible
- 1000 V rating.

Smart plug-in jumpers

Pre-cut poles removable by hand: clean cut.

Insulated up to 1000 V (avoid use of separators).

Predefined shapes in molding to easily identify connected poles with a pen.



Plug-in individual test adapter

Plug-in test connector



Pre-cut poles easy removable by hand

Predefined shape to identify connected poles

Pluggable technology - SNK series, terminal blocks

Features and benefits

Optimized logistics

Reduce your accessories inventory by up to 50%

SNK PI-Spring, screw and pluggable ranges share the same accessories.

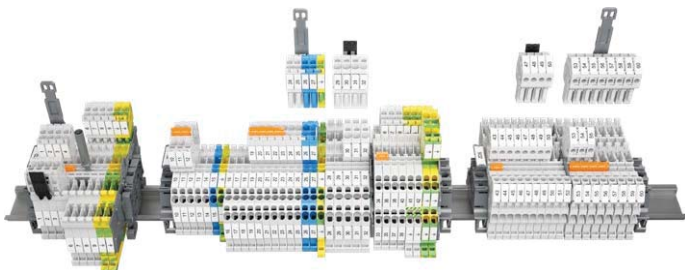

Shared accessories for SNK PI-Spring, screw and pluggable ranges

Facilitate maintenance operations

Terminal blocks can be individually removed from a terminal assembly equipped with markers: TE Connectivity markers become independent after strip mounting. The markers remain on terminal in any situation.

Markers are interchangeable: the smaller marker can fit any bigger block.



Maintenance operations facilitated

Reliable in harsh conditions

Qualified for worldwide markets, applications and for severe environments: vibration, shock, corrosion...





SNK series, terminal blocks

Pluggable technology - Range overview from 2.5 to 4 mm² - 12 to 10 AWG

Pluggable Pluggable

2

Connections
Single deck
Feed-through

4

Connections
Single deck
Feed-through
Ground

PI-Spring Pluggable

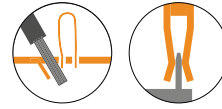

PI-Spring Pluggable

2

Connections
Single deck
Feed-through
Ground

3

Connections
Single deck
Feed-through

4

Connections
Single deck
Feed-through
Ground

Plugs

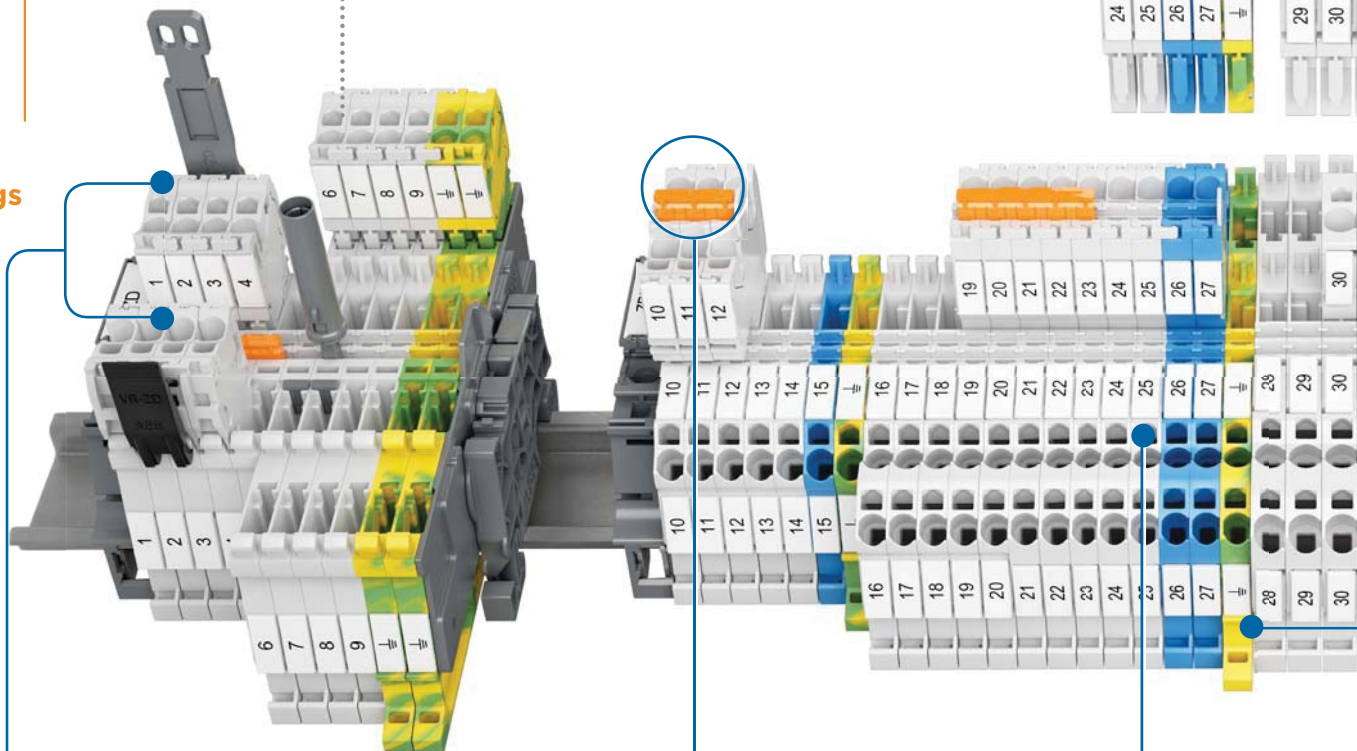

Compact plug

Save up to 15%
in height

Jumper plugs

Plugs with 1 or 2 connection
& jumper to ease potential
distribution

Reduced plug variants

Only two plugs variants
to create assemblies

Voltage test

Screwdriver entry point
accepts category II probes

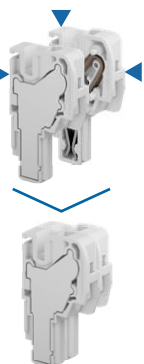

2x2

Connections

Double deck
Feed-through
Ground

Screw clamp Pluggable

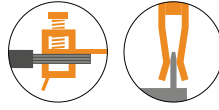

4

Connections

Single deck
Feed-through

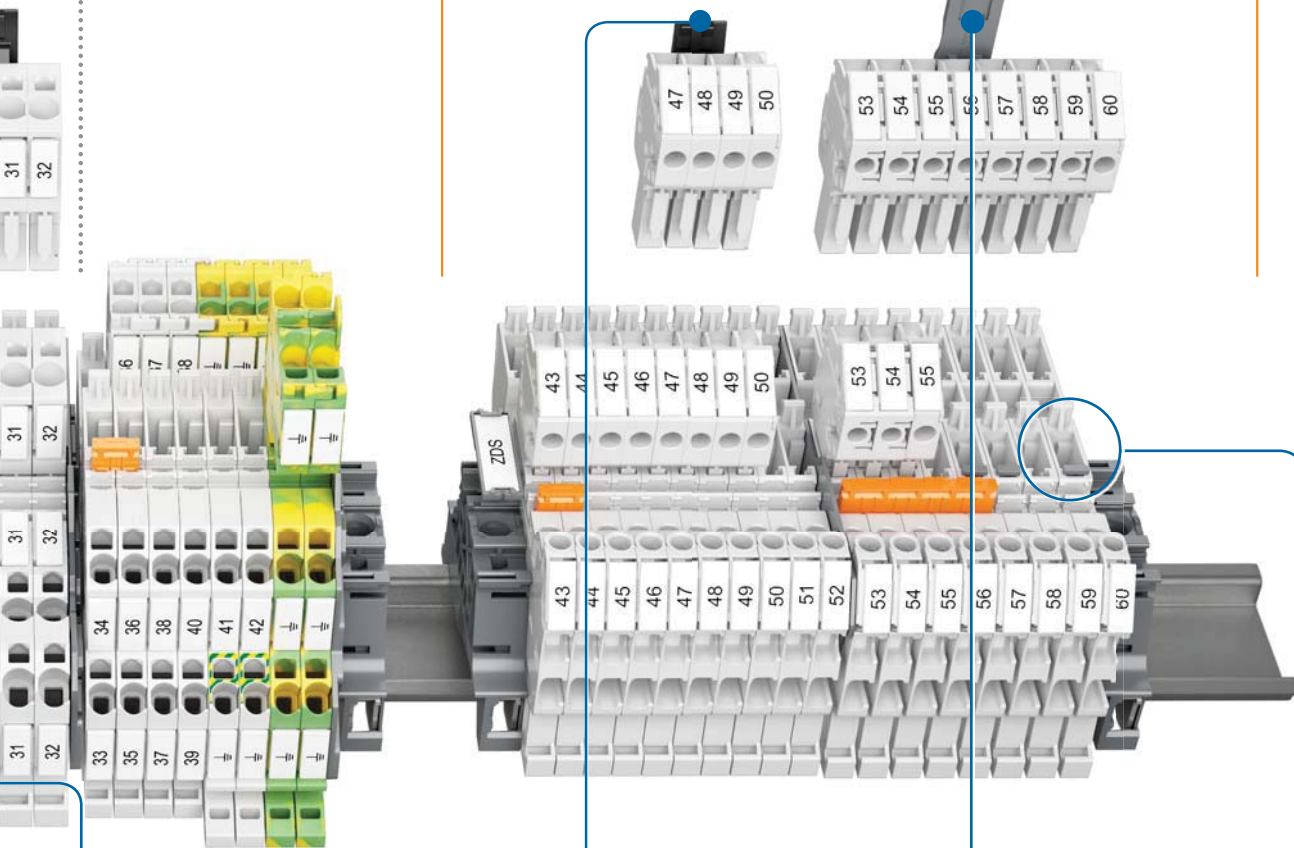

End section

No need of end section between 2.5 and 4 mm² terminal blocks



Locking device

Secure plug and wiring against accidental pulling

Cable clamp

Secure the wires onto the plug when pulling the plug assembly

Convenient coding pegs

Guarantee error free plugs insertion



15NKT64013S0201

SNK series, terminal blocks

Pluggable technology



PI-Spring Pluggable

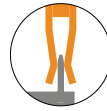

Single deck



		Feed-through		Ground	Feed-through		Ground	
Section								
2.5 mm ²	12 AWG	ZD2.5-11	ZD2.5-22	ZD2.5-22-PE	ZDK2.5-11	ZDK2.5-21	ZDK2.5-22	ZDK2.5-11-PE
4 mm ²	10 AWG					ZDK4-22		ZDK2.5-22-PE

Double deck



		Feed-through	Feed-through + ground	Ground
Section				
2.5 mm ²	12 AWG	ZDK2.5-D2	ZDK2.5-D1	ZDK2.5-D2-PE
4 mm ²	10 AWG			ZDK2.5-D1-PE

PI-Spring female plugs



		Closed		Closed		Closed		Closed		Closed		Closed	
Section													
2.5 mm ²	12 AWG	CDK2.5	CDK2.5-E	CDK2.5-J	CDK2.5-J-E	CDK2.5-2P-J	CDK2.5-2P-J-E	CDK2.5-PE	CDK2.5-PE-E	CDK2.5-J-PE	CDK2.5-J-PE-E	CDK2.5-2P-J-PE	CDK2.5-2P-J-PE
4 mm ²	10 AWG	CDK4	CDK4-E										



Screw clamp Pluggable

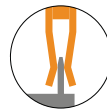

Single deck

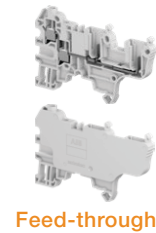

		Feed-through
Section		
4 mm ²	10 AWG	ZDS4-22 ZDS4-22-R1

Screw clamp female plugs



		Closed	
Section			
4 mm ²	10 AWG	CDS4 CDS4-R1	CDS4-E

clamp -
 Channels for jumpering or testing -
 test socket -
 Blown-fuse indicator -
 male pluggable clamp -
 female pluggable clamp

PI-Spring Pluggable

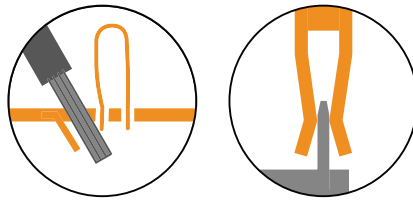

ZD2.5-11 PI-Spring pluggable terminal blocks

Feed-through - 5.2 mm 0.205 in spacing



ZD2.5-11

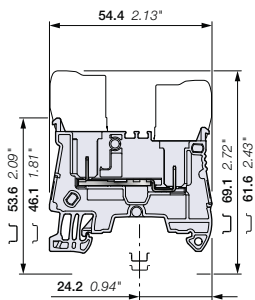

5.2 mm 0.205 in spacing

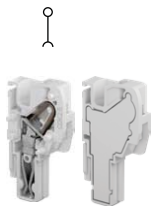

CDK2.5 CDK2.5-E

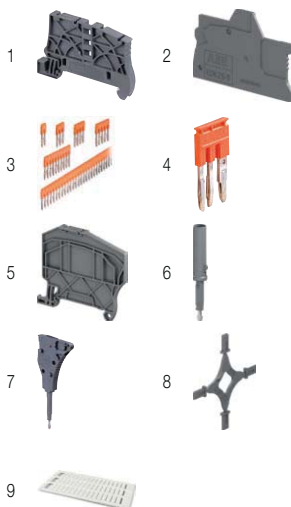

Description

- Increase your productivity with pluggable terminal blocks: possibility of pre-produced plugs harnesses, time saving plug and play assembly, reduced transportation panels preparation and final installation, easily connect sub-assemblies together,
- Simplify and secure your installation: in site faulty connection errors are eliminated, prior connection testing is eased and reliable, test connectors (TC5) withstanding 10 000 operations are compatible for convenient testing.

Ordering details

Description	Color	Type	Part Number	Pkg qty	Weight (1 pce) g
Feed-through 2 connections	Grey <input type="checkbox"/>	ZD2.5-11	1SNK805016R0000	50	5.66

Main technical data

Connecting capacity	IEC	UL - CSA	Mounting instructions
1 conductor per clamp	Rigid: Solid/Stranded	0.2 ... 4 mm ²	26 ... 12 AWG
	Flexible without ferrule	0.22 ... 2.5 mm ²	26 ... 14 AWG
	Flexible with non insulated ferrule	0.22 ... 2.5 mm ²	26 ... 14 AWG
	Flexible with insulated ferrule	0.22 ... 2.5 mm ²	26 ... 14 AWG
2 conductors per clamp	Flexible with twin ferrule	0.22 ... 0.5 mm ²	26 ... 20 AWG
	Rated current / Rated cross section	22 A / 2.5 mm ²	20 A / 12 AWG
Rated short-time withstand current (1s)	300 A		
Rated voltage	1000 V	600 V	
Impulse withstand voltage	8000 V		
Protection	IP20	NEMA 1	

The connecting capacity data for one Rigid: Solid/Stranded, or one Flexible conductor (when applicable) is a mandatory information required by IEC, UL and CSA standards (Copper conductors). All other data are provided as supplementary information only. For more details, please consult our CB, UL or CSA certificates and technical datasheet available on <http://www.TE.com>



Female plugs

Description	Color	Type	Part Number	Pkg qty	Weight (1 pce) g
Female plugs 1 pole	Grey <input type="checkbox"/>	CDK2.5	1SNK805712R0000	50	2.80
Female plugs without outer nubs - Closed 15 poles max.		CDK2.5-E	1SNK805713R0000	50	2.88

Accessories

Description	Color	Type	Part Number	Pkg qty	Weight (1 pce) g	
1 End stops 5.2 mm 0.205 in	Dark grey <input type="checkbox"/>	BAZ1	1SNK900002R0000	50	5.30	
2 End sections 1.5 mm 0.059 in	Dark grey <input type="checkbox"/>	EDK2.5-11	1SNK805915R0000	20	1.49	
3 Jumper bars 2 poles 32 A (IEC)	Orange <input type="checkbox"/>	JB5-2	1SNK905302R0000	50	1.30	
		3 poles 32 A (IEC)	JB5-3	1SNK905303R0000	50	2.00
		4 poles 32 A (IEC)	JB5-4	1SNK905304R0000	50	2.70
		5 poles 32 A (IEC)	JB5-5	1SNK905305R0000	50	3.50
		10 poles 32 A (IEC)	JB5-10	1SNK905310R0000	30	7.10
50 poles 32 A (IEC)	JB5-50	1SNK905350R0000	10	36.00		
4 Cross spacing jumpers 3 poles 32 A (IEC)	Orange <input type="checkbox"/>	JB85-3	1SNK900603R0000	10	2.80	
5 Circuit separators 3 mm 0.118 in	Dark grey <input type="checkbox"/>	CS-R2	1SNK900106R0000	20	3.80	
6 Test adapters For test plugs DIA 2 mm 0.079 in	Dark grey <input type="checkbox"/>	TP2	1SNK900203R0000	20	1.70	
		TP4	1SNK900205R0000	20	2.40	
7 Test connectors 5.2 mm 0.205 in spacing	Dark grey <input type="checkbox"/>	TC5	1SNK900200R0000	10	5.20	
		TC5-R1	1SNK900201R0000	10	5.20	
8 Coding pegs End module, 5.2 mm 0.205 in	Dark grey <input type="checkbox"/>	COP-ZD	1SNK900636R0000	10	3.57	
9 Terminal block markers	White <input type="checkbox"/>	MC512	1SNK140000R0000	22	9.00	
		MC512PA	1SNK149999R0000	20	10.00	
		MG-CPM 13 41790	1SNB041790R0512	1960	0.236	
Universal wire markers holder	Grey <input type="checkbox"/>	UMH	1SNK900611R0000	10	0.20	

Complete list of accessories is indicated in the terminal block datasheet including end stops.

Some accessories such as jumper bars may modify the terminal block's ratings: Complete information available in the accessories section of the catalog.

Technical data valid for copper conductors only.

ZD2.5-22 PI-Spring pluggable terminal blocks

Feed-through - 5.2 mm 0.205 in spacing

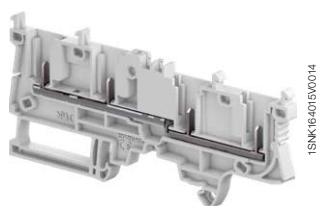

1SNK805017R0000

ZD2.5-22

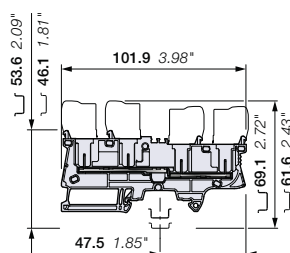

5.2 mm 0.205 in spacing



CDK2.5 CDK2.5-E



Description

- Increase your productivity with pluggable terminal blocks: possibility of pre-produced plugs harnesses, time saving plug and play assembly, reduced transportation panels preparation and final installation, easily connect sub-assemblies together,
- Simplify and secure your installation: in site faulty connection errors are eliminated, prior connection testing is eased and reliable, test connectors (TC5) withstanding 10 000 operations are compatible for convenient testing.

Ordering details

Description	Color	Type	Part Number	Pkg qty	Weight (1 pce) g
Feed-through 4 connections	Grey <input type="checkbox"/>	ZD2.5-22	1SNK805017R0000	50	12.00

Main technical data

Connecting capacity	IEC	UL - CSA	Rail	TH 35-7.5, TH 35-15
1 conductor per clamp	Rigid: Solid/Stranded	0.2 ... 4 mm ²	26 ... 12 AWG	11 mm 0.433 in
	Flexible without ferrule	0.22 ... 2.5 mm ²	26 ... 14 AWG	
	Flexible with non insulated ferrule	0.22 ... 2.5 mm ²	26 ... 14 AWG	
	Flexible with insulated ferrule	0.22 ... 2.5 mm ²	26 ... 14 AWG	
2 conductors per clamp	Flexible with twin ferrule	0.22 ... 0.5 mm ²	26 ... 20 AWG	
Rated current / Rated cross section	22 A / 2.5 mm ²	20 A / 12 AWG		
Rated short-time withstand current (1s)	300 A			
Rated voltage	1000 V	600 V		
Impulse withstand voltage	8000 V			
Protection	IP20	NEMA 1		

Mounting instructions

Wire stripping length	Tool (for flexible conductor without ferrule)	Flat screwdriver
		Ø 3.5 mm Ø 0.138 in

The connecting capacity data for one Rigid: Solid/Stranded, or one Flexible conductor (when applicable) is a mandatory information required by IEC, UL and CSA standards (Copper conductors). All other data are provided as supplementary information only. For more details, please consult our CB, UL or CSA certificates and technical datasheet available on <http://www.TE.com>

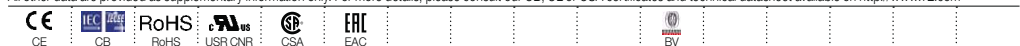

Female plugs

Description	Color	Type	Part Number	Pkg qty	Weight (1 pce) g
Female plugs 1 pole	Grey <input type="checkbox"/>	CDK2.5	1SNK805712R0000	50	2.80
Female plugs without outer nubs - Closed		CDK2.5-E	1SNK805713R0000	50	2.88

15 poles max.

Accessories

Description	Color	Type	Part Number	Pkg qty	Weight (1 pce) g	
1 End stops 5.2 mm 0.205 in	Dark grey <input type="checkbox"/>	BAZ1	1SNK900002R0000	50	5.30	
2 End sections 2.0 mm 0.079 in	Dark grey <input type="checkbox"/>	ED2.5-22	1SNK805917R0000	20	3.64	
3 Jumper bars	Orange <input type="checkbox"/>	2 poles 32 A (IEC)	JB5-2	1SNK905302R0000	50	1.30
		3 poles 32 A (IEC)	JB5-3	1SNK905303R0000	50	2.00
		4 poles 32 A (IEC)	JB5-4	1SNK905304R0000	50	2.70
		5 poles 32 A (IEC)	JB5-5	1SNK905305R0000	50	3.50
		10 poles 32 A (IEC)	JB5-10	1SNK905310R0000	30	7.10
50 poles 32 A (IEC)	JB5-50	1SNK905350R0000	10	36.00		
4 Cross spacing jumpers 3 poles 32 A (IEC)	Orange <input type="checkbox"/>	JB85-3	1SNK900603R0000	10	2.80	
5 Circuit separators 3 mm 0.118 in	Dark grey <input type="checkbox"/>	CS-R3	1SNK900107R0000	20	6.40	
6 Test adapters	Dark grey <input type="checkbox"/>	For test plugs DIA 2 mm 0.079 in	TP2	1SNK900203R0000	20	1.70
		For test plugs DIA 4 mm 0.157 in	TP4	1SNK900205R0000	20	2.40
7 Test connectors	Dark grey <input type="checkbox"/>	5.2 mm 0.205 in spacing	TC5	1SNK900200R0000	10	5.20
		End module, 5.2 mm 0.205 in	TC5-R1	1SNK900201R0000	10	5.20
8 Coding pegs	Dark grey <input type="checkbox"/>	COP-ZD	1SNK900636R0000	10	3.57	
9 Terminal block markers	White <input type="checkbox"/>	Blank card	MC512	1SNK140000R0000	22	9.00
		Blank marker	MG-CPM 13 41790	1SNB041790R0512	1960	0.236
		Universal wire markers holder	UMH	1SNK900611R0000	10	0.20

Complete list of accessories is indicated in the terminal block datasheet including end stops.

Some accessories such as jumper bars may modify the terminal block's ratings: Complete information available in the accessories section of the catalog.

Technical data valid for copper conductors only.

1SNK16402150201

ZD2.5-22-PE PI-Spring pluggable terminal blocks

Ground - 5.2 mm 0.205 in spacing



ZD2.5-22-PE

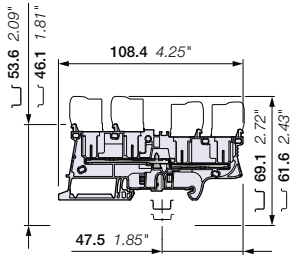

5.2 mm 0.205 in spacing

Description

- Increase your productivity with pluggable terminal blocks: possibility of pre-produced plugs harnesses, time saving plug and play assembly, reduced transportation panels preparation and final installation, easily connect sub-assemblies together,
- Simplify and secure your installation: in site faulty connection errors are eliminated, prior connection testing is eased and reliable, test connectors (TC5) withstanding 10 000 operations are compatible for convenient testing.

Ordering details

Description	Color	Type	Part Number	Pkg qty	Weight (1 pce) g
Ground 4 connections	Green-yellow	ZD2.5-22-PE	1SNK805156R0000	50	14.80

Main technical data

Connecting capacity	IEC	UL - CSA	Mounting instructions		
1 conductor per clamp	Rigid: Solid/Stranded	0.2 ... 4 mm ²	26 ... 12 AWG	Rail	TH 35-7.5, TH 35-15
	Flexible without ferrule	0.22 ... 2.5 mm ²	26 ... 14 AWG	Wire stripping length	11 mm 0.433 in
	Flexible with non insulated ferrule	0.22 ... 2.5 mm ²	26 ... 14 AWG		Tool (for flexible conductor without ferrule)
	Flexible with insulated ferrule	0.22 ... 2.5 mm ²	26 ... 14 AWG		
Rated cross section	2.5 mm ²	12 AWG			
Rated short-time withstand current (1s)	300 A	396 A			
Protection	IP20	NEMA 1			

The connecting capacity data for one Rigid: Solid/Stranded, or one Flexible conductor (when applicable) is a mandatory information required by IEC, UL and CSA standards (Copper conductors). All other data are provided as supplementary information only. For more details, please consult our CB, UL or CSA certificates and technical datasheet available on <http://www.TE.com>



Available in Q3.2019

CDK2.5-PE CDK2.5-PE-E

Female plugs

Description	Color	Type	Part Number	Pkg qty	Weight (1 pce) g
Female plugs 1 pole	Green-yellow	CDK2.5-PE	1SNK805750R0000	50	2.80
Female plugs without outer nubs - Closed 15 poles max.		CDK2.5-PE-E	1SNK805753R0000	50	2.88

Accessories

Description	Color	Type	Part Number	Pkg qty	Weight (1 pce) g	
1 End stops 5.2 mm 0.205 in	Dark grey	BAZ1	1SNK900002R0000	50	5.30	
2 End sections 2.0 mm 0.079 in	Dark grey	ED2.5-22	1SNK805917R0000	20	3.64	
3 Circuit separators 3 mm 0.118 in	Dark grey	CS-R3	1SNK900107R0000	20	6.40	
4 Test adapters	Dark grey	For test plugs DIA 2 mm 0.079 in	TP2	1SNK900203R0000	20	1.70
		For test plugs DIA 4 mm 0.157 in	TP4	1SNK900205R0000	20	2.40
5 Test connectors 5.2 mm 0.205 in spacing	Dark grey	End module, 5.2 mm 0.205 in	TC5	1SNK900200R0000	10	5.20
			TC5-R1	1SNK900201R0000	10	5.20
6 Coding pegs	Dark grey	COP-ZD	1SNK900636R0000	10	3.57	
7 Terminal block markers	White	Blank card	MC512	1SNK140000R0000	22	9.00
			MC512PA	1SNK149999R0000	20	10.00
		Blank marker	MG-CPM 13 41790	1SNB041790R0512	1960	0.236
		Universal wire markers holder	Grey	UMH	1SNK900611R0000	10

Complete list of accessories is indicated in the terminal block datasheet including end stops. Some accessories such as jumper bars may modify the terminal block's ratings: Complete information available in the accessories section of the catalog.

Technical data valid for copper conductors only.

ZDK2.5-11 PI-Spring pluggable terminal blocks

Feed-through - 5.2 mm 0.205 in spacing

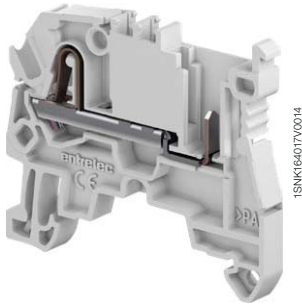

ZDK2.5-11

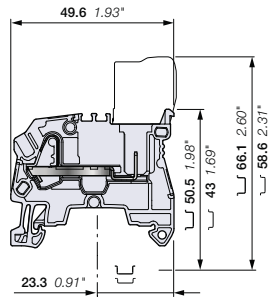

5.2 mm 0.205 in spacing

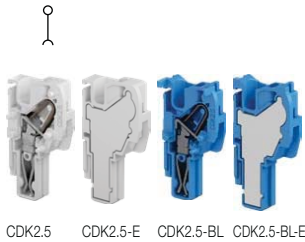

CDK2.5 CDK2.5-E CDK2.5-BL CDK2.5-BL-E

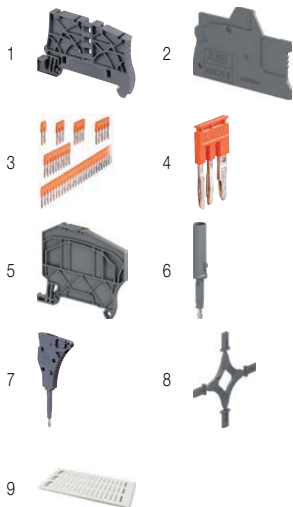

Description

- Increase your productivity with pluggable terminal blocks: possibility of pre-produced plugs harnesses, time saving plug and play assembly, reduced transportation panels preparation and final installation, easily connect sub-assemblies together,
- Simplify and secure your installation: in site faulty connection errors are eliminated, prior connection testing is eased and reliable, test connectors (TC5) withstanding 10 000 operations are compatible for convenient testing.

Ordering details

Description	Color	Type	Part Number	Pkg qty	Weight (1 pce) g
Feed-through 2 connections	Grey	ZDK2.5-11	1SNK805015R0000	50	7.00
	Blue	ZDK2.5-11-BL	1SNK805025R0000	50	7.00

Main technical data

Connecting capacity	IEC	UL - CSA	Mounting instructions
1 conductor per clamp	Rigid: Solid/Stranded	0.2 ... 4 mm ²	26 ... 12 AWG
	Flexible without ferrule	0.22 ... 2.5 mm ²	26 ... 14 AWG
	Flexible with non insulated ferrule	0.22 ... 2.5 mm ²	26 ... 14 AWG
	Flexible with insulated ferrule	0.22 ... 2.5 mm ²	26 ... 14 AWG
2 conductors per clamp	Flexible with twin ferrule	0.22 ... 0.5 mm ²	26 ... 20 AWG
Rated current / Rated cross section	24 A / 2.5 mm ²	20 A / 12 AWG	
Rated short-time withstand current (1s)	300 A		
Rated voltage	1000 V	600 V	
Impulse withstand voltage	8000 V		
Protection	IP20	NEMA 1	

The connecting capacity data for one Rigid: Solid/Stranded, or one Flexible conductor (when applicable) is a mandatory information required by IEC, UL and CSA standards (Copper conductors). All other data are provided as supplementary information only. For more details, please consult our CB, UL or CSA certificates and technical datasheet available on <http://www.TE.com>



Female plugs

Description	Color	Type	Part Number	Pkg qty	Weight (1 pce) g
Female plugs 1 pole	Grey	CDK2.5	1SNK805712R0000	50	2.80
Female plugs without outer nubs - Closed		CDK2.5-E	1SNK805713R0000	50	2.88
Female plugs 1 pole	Blue	CDK2.5-BL	1SNK805742R0000	50	2.80
Female plugs without outer nubs - Closed		CDK2.5-BL-E	1SNK805743R0000	50	2.88

15 poles max.

Accessories

Description	Color	Type	Part Number	Pkg qty	Weight (1 pce) g	
1 End stops 5.2 mm 0.205 in	Dark grey	BAZ1	1SNK900002R0000	50	5.30	
2 End sections 1.5 mm 0.059 in	Dark grey	EDK2.5-11	1SNK805915R0000	20	1.49	
3 Jumper bars 2 poles 32 A (IEC)	Orange	JB5-2	1SNK905302R0000	50	1.30	
		3 poles 32 A (IEC)	JB5-3	1SNK905303R0000	50	2.00
		4 poles 32 A (IEC)	JB5-4	1SNK905304R0000	50	2.70
		5 poles 32 A (IEC)	JB5-5	1SNK905305R0000	50	3.50
		10 poles 32 A (IEC)	JB5-10	1SNK905310R0000	30	7.10
		50 poles 32 A (IEC)	JB5-50	1SNK905350R0000	10	36.00
4 Cross spacing jumpers 3 poles 32 A (IEC)	Orange	JB85-3	1SNK900603R0000	10	2.80	
5 Circuit separators 3 mm 0.118 in	Dark grey	CS-R2	1SNK900106R0000	20	3.80	
6 Test adapters For test plugs DIA 2 mm 0.079 in	Dark grey	TP2	1SNK900203R0000	20	1.70	
		TP4	1SNK900205R0000	20	2.40	
7 Test connectors 5.2 mm 0.205 in spacing	Dark grey	TC5	1SNK900200R0000	10	5.20	
		TC5-R1	1SNK900201R0000	10	5.20	
8 Coding pegs End module, 5.2 mm 0.205 in	Dark grey	COP-ZD	1SNK900636R0000	10	3.57	
9 Terminal block markers Blank card	White	MC512	1SNK140000R0000	22	9.00	
		MC512PA	1SNK149999R0000	20	10.00	
		MG-CPM 13 41790	1SNB041790R0512	1960	0.236	
		Universal wire markers holder	UMH	1SNK900611R0000	10	0.20

Complete list of accessories is indicated in the terminal block datasheet including end stops.

Some accessories such as jumper bars may modify the terminal block's ratings: Complete information available in the accessories section of the catalog.

Technical data valid for copper conductors only.

1SNK1640235/0201

ZDK2.5-21 PI-Spring pluggable terminal blocks

Feed-through - 5.2 mm 0.205 in spacing

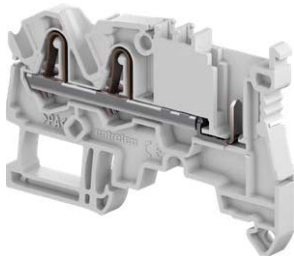

ZDK2.5-21

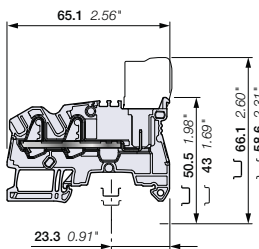

5.2 mm 0.205 in spacing



CDK2.5 CDK2.5-E

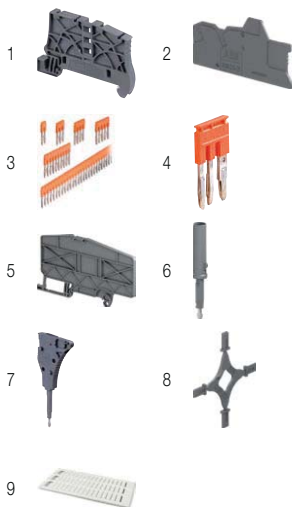

Description

- Increase your productivity with pluggable terminal blocks: possibility of pre-produced plugs harnesses, time saving plug and play assembly, reduced transportation panels preparation and final installation, easily connect sub-assemblies together,
- Simplify and secure your installation: in site faulty connection errors are eliminated, prior connection testing is eased and reliable, test connectors (TC5) withstanding 10 000 operations are compatible for convenient testing.

Ordering details

Description	Color	Type	Part Number	Pkg qty	Weight (1 pce) g
Feed-through 3 connections	Grey <input type="checkbox"/>	ZDK2.5-21	1SNK805014R0000	50	7.47

Main technical data

Connecting capacity	IEC	UL - CSA	Rail	TH 35-7.5, TH 35-15	
1 conductor per clamp	Rigid: Solid/Stranded	0.2 ... 4 mm ²	26 ... 12 AWG	Wire stripping length	11 mm 0.433 in
	Flexible without ferrule	0.22 ... 2.5 mm ²	26 ... 14 AWG	Tool (for flexible conductor without ferrule)	Flat screwdriver Ø 3.5 mm Ø 0.138 in
	Flexible with non insulated ferrule	0.22 ... 2.5 mm ²	26 ... 14 AWG		
	Flexible with insulated ferrule	0.22 ... 2.5 mm ²	26 ... 14 AWG		
Flexible with twin ferrule	0.22 ... 0.5 mm ²	26 ... 20 AWG			
2 conductors per clamp					
Rated current / Rated cross section	24 A / 2.5 mm ²	20 A / 12 AWG			
Rated short-time withstand current (1s)	300 A				
Rated voltage	1000 V	600 V			
Impulse withstand voltage	8000 V				
Protection	IP20	NEMA 1			

The connecting capacity data for one Rigid: Solid/Stranded, or one Flexible conductor (when applicable) is a mandatory information required by IEC, UL and CSA standards (Copper conductors). All other data are provided as supplementary information only. For more details, please consult our CB, UL or CSA certificates and technical datasheet available on <http://www.TE.com>



Female plugs

Description	Color	Type	Part Number	Pkg qty	Weight (1 pce) g
Female plugs 1 pole	Grey <input type="checkbox"/>	CDK2.5	1SNK805712R0000	50	2.80
Female plugs without outer nubs - Closed 15 poles max.		CDK2.5-E	1SNK805713R0000	50	2.88

Accessories

Description	Color	Type	Part Number	Pkg qty	Weight (1 pce) g	
1 End stops 5.2 mm 0.205 in	Dark grey <input type="checkbox"/>	BAZ1	1SNK900002R0000	50	5.30	
2 End sections 1.5 mm 0.059 in	Dark grey <input type="checkbox"/>	EDK2.5-21	1SNK805914R0000	20	1.90	
3 Jumper bars	Orange <input type="checkbox"/>	2 poles 32 A (IEC)	JB5-2	1SNK905302R0000	50	1.30
		3 poles 32 A (IEC)	JB5-3	1SNK905303R0000	50	2.00
		4 poles 32 A (IEC)	JB5-4	1SNK905304R0000	50	2.70
		5 poles 32 A (IEC)	JB5-5	1SNK905305R0000	50	3.50
		10 poles 32 A (IEC)	JB5-10	1SNK905310R0000	30	7.10
		50 poles 32 A (IEC)	JB5-50	1SNK905350R0000	10	36.00
4 Cross spacing jumpers 3 poles 32 A (IEC)	Orange <input type="checkbox"/>	JB85-3	1SNK900603R0000	10	2.80	
5 Circuit separators 3 mm 0.118 in	Dark grey <input type="checkbox"/>	CS-R3	1SNK900107R0000	20	6.40	
6 Test adapters	Dark grey <input type="checkbox"/>	For test plugs DIA 2 mm 0.079 in	TP2	1SNK900203R0000	20	1.70
		For test plugs DIA 4 mm 0.157 in	TP4	1SNK900205R0000	20	2.40
7 Test connectors	Dark grey <input type="checkbox"/>	5.2 mm 0.205 in spacing	TC5	1SNK900200R0000	10	5.20
		End module, 5.2 mm 0.205 in	TC5-R1	1SNK900201R0000	10	5.20
8 Coding pegs	Dark grey <input type="checkbox"/>	COP-ZD	1SNK900636R0000	10	3.57	
9 Terminal block markers	White <input type="checkbox"/>	MC512	1SNK140000R0000	22	9.00	
		MC512PA	1SNK149999R0000	20	10.00	
		Blank marker	MG-CPM 13 41790	1SNB041790R0512	1960	0.236
Universal wire markers holder	Grey <input type="checkbox"/>	UMH	1SNK900611R0000	10	0.20	

Complete list of accessories is indicated in the terminal block datasheet including end stops. Some accessories such as jumper bars may modify the terminal block's ratings: Complete information available in the accessories section of the catalog.

Technical data valid for copper conductors only.

ZDK2.5-22 PI-Spring pluggable terminal blocks

Feed-through - 5.2 mm 0.205 in spacing



ZDK2.5-22

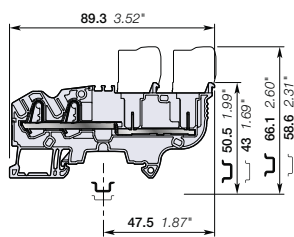

5.2 mm 0.205 in spacing

Description

- Increase your productivity with pluggable terminal blocks: possibility of pre-produced plugs harnesses, time saving plug and play assembly, reduced transportation panels preparation and final installation, easily connect sub-assemblies together,
- Simplify and secure your installation: in site faulty connection errors are eliminated, prior connection testing is eased and reliable, test connectors (TC5) withstanding 10 000 operations are compatible for convenient testing.

Ordering details

Description	Color	Type	Part number	Pkg qty	Weight (1 pce) g
Feed-through 4 connections	Grey <input type="checkbox"/>	ZDK2.5-22	1SNK805010R0000	50	9.60
Feed-through 4 connections	Blue <input type="checkbox"/>	ZDK2.5-22-BL	1SNK805020R0000	50	9.60

Main technical data

Connecting capacity	IEC	UL - CSA	Mounting instructions
1 conductor per clamp	Rigid: Solid/Stranded	0.2 ... 4 mm ²	26 ... 12 AWG
	Flexible without ferrule	0.22 ... 2.5 mm ²	26 ... 14 AWG
	Flexible with non insulated ferrule	0.22 ... 2.5 mm ²	26 ... 14 AWG
	Flexible with insulated ferrule	0.22 ... 2.5 mm ²	26 ... 14 AWG
2 conductors per clamp	Flexible with twin ferrule	0.22 ... 0.5 mm ²	26 ... 20 AWG
Rated current / Rated cross section		24 A / 2.5 mm ²	22 A / 12 AWG
Rated short-time withstand current (1s)		300 A	
Rated voltage		1000 V	600 V
Impulse withstand voltage		8000 V	
Protection		IP20	NEMA 1

The connecting capacity data for one Rigid: Solid/Stranded, or one Flexible conductor (when applicable) is a mandatory information required by IEC, UL and CSA standards (Copper conductors). All other data are provided as supplementary information only. For more details, please consult our CB, UL or CSA certificates and technical datasheet available on <http://www.TE.com>

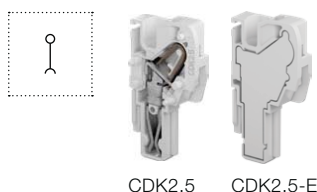
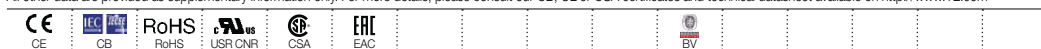

CDK2.5 CDK2.5-E

Female plugs

Description	Color	Type	Part number	Pkg qty	Weight (1 pce) g
Female plugs 1 pole	Grey <input type="checkbox"/>	CDK2.5	1SNK805712R0000	50	2.80
Female plugs without outer nubs - Closed 15 poles max.		CDK2.5-E	1SNK805713R0000	50	2.80

Accessories



Description	Color	Type	Part number	Pkg qty	Weight (1 pce) g	
1 End stops 5.2 mm 0.205 in	Dark grey <input type="checkbox"/>	BAZ1	1SNK900002R0000	50	5.30	
2 End sections 2.2 mm 0.087 in	Dark grey <input type="checkbox"/>	EDK2.5-22	1SNK805910R0000	20	3.15	
3 Jumper bars	Orange <input type="checkbox"/>	2 poles 32 A (IEC)	JB5-2	1SNK905302R0000	50	1.30
		3 poles 32 A (IEC)	JB5-3	1SNK905303R0000	50	2.00
		4 poles 32 A (IEC)	JB5-4	1SNK905304R0000	50	2.70
		5 poles 32 A (IEC)	JB5-5	1SNK905305R0000	50	3.50
		10 poles 32 A (IEC)	JB5-10	1SNK905310R0000	30	7.10
50 poles 32 A (IEC)	JB5-50	1SNK905350R0000	10	36.00		
4 Cross spacing jumpers 3 poles 32 A (IEC)	Orange <input type="checkbox"/>	JB85-3	1SNK900603R0000	10	2.80	
5 Circuit separators 3 mm 0.118 in	Dark grey <input type="checkbox"/>	CS-R3	1SNK900107R0000	20	6.40	
6 Test adapters	Dark grey <input type="checkbox"/>	For test plugs DIA 2 mm 0.079 in	TP2	1SNK900203R0000	20	1.70
		For test plugs DIA 4 mm 0.157 in	TP4	1SNK900205R0000	20	2.40
		5.2 mm 0.205 in spacing	TC5	1SNK900200R0000	10	5.20
7 Test connectors	Dark grey <input type="checkbox"/>	End module, 5.2 mm 0.205 in	TC5-R1	1SNK900201R0000	10	5.20
			COP-ZD	1SNK900636R0000	10	3.57
8 Coding pegs	Dark grey <input type="checkbox"/>		MG-CPM 13 41790	1960	0.23	
			MC512	1SNK140000R0000	22	9.00
			MC512PA	1SNK149999R0000	20	10.00
9 Terminal block markers	Grey <input type="checkbox"/>	UMH	1SNK900611R0000	10	0.20	

Complete list of accessories is indicated in the terminal block datasheet including end stops.

Some accessories such as jumper bars may modify the terminal block's ratings: Complete information available in the accessories section of the catalog.

Technical data valid for copper conductors only.

ZDK4-22 PI-Spring pluggable terminal blocks

Feed-through - 6 mm 0.236 in spacing



ZDK4-22

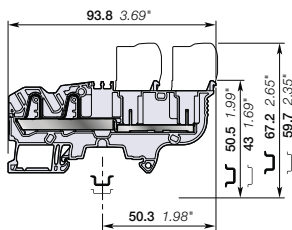

6 mm 0.236 in spacing

Description

- Increase your productivity with pluggable terminal blocks: possibility of pre-produced plugs harnesses, time saving plug and play assembly, reduced transportation panels preparation and final installation, easily connect sub-assemblies together,
- Simplify and secure your installation: in site faulty connection errors are eliminated, prior connection testing is eased and reliable, test connectors (TC5-R1 + ES-TC6) withstanding 10 000 operations are compatible for convenient testing.

Ordering details

Description	Color	Type	Part Number	Pkg qty	Weight (1 pce) g
Feed-through 4 connections	Grey <input type="checkbox"/>	ZDK4-22	1SNK806010R0000	50	14.30

Main technical data

Connecting capacity		IEC	UL - CSA	Mounting instructions	
1 conductor per clamp	Rigid: Solid/Stranded	0.5 ... 6 mm²	26 ... 10 AWG	Rail	TH 35-7.5, TH 35-15
	Flexible without ferrule	0.5 ... 4 mm²	26 ... 10 AWG	Wire stripping length	12.5 mm 0.492 in
	Flexible with non insulated ferrule	0.5 ... 4 mm²	26 ... 12 AWG	Tool (for flexible conductor without ferrule)	Flat screwdriver Ø 3.5 mm Ø 0.138 in
	Flexible with insulated ferrule	0.5 ... 4 mm²	26 ... 12 AWG		
2 conductors per clamp	Flexible with twin ferrule	0.5 ... 1 mm²	26 ... 18 AWG		
Rated current / Rated cross section		30 A / 4 mm²	30 A / 10 AWG		
Rated short-time withstand current (1s)		480 A			
Rated voltage		1000 V	600 V		
Impulse withstand voltage		8000 V			
Protection		IP20	NEMA 1		

The connecting capacity data for one Rigid: Solid/Stranded, or one Flexible conductor (when applicable) is a mandatory information required by IEC, UL and CSA standards (Copper conductors). All other data are provided as supplementary information only. For more details, please consult our CB, UL or CSA certificates and technical datasheet available on <http://www.TE.com>

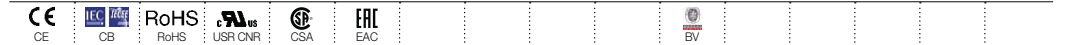

Female plugs

Description	Color	Type	Part Number	Pkg qty	Weight (1 pce) g
Female plugs 1 pole	Grey <input type="checkbox"/>	CDK4	1SNK806712R0000	50	3.80
Female plugs without outer nubs - Closed		CDK4-E	1SNK806713R0000	50	4.50

15 poles max.

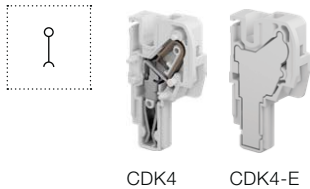

CDK4

CDK4-E

Accessories

Description	Color	Type	Part Number	Pkg qty	Weight (1 pce) g	
1 End stops 5.2 mm 0.205 in	Dark grey <input checked="" type="checkbox"/>	BAZ1	1SNK900002R0000	50	5.30	
2 End sections 2.2 mm 0.087 in	Dark grey <input checked="" type="checkbox"/>	EDK2.5-22	1SNK805910R0000	20	3.15	
3 Jumper bars	Orange <input checked="" type="checkbox"/>	2 poles 41 A (IEC)	JB6-2	1SNK906302R0000	50	1.30
		3 poles 41 A (IEC)	JB6-3	1SNK906303R0000	50	2.10
		4 poles 41 A (IEC)	JB6-4	1SNK906304R0000	50	2.90
		5 poles 41 A (IEC)	JB6-5	1SNK906305R0000	50	3.60
		10 poles 41 A (IEC)	JB6-10	1SNK906310R0000	20	7.40
		50 poles 41 A (IEC)	JB6-50	1SNK906350R0000	10	38.10
4 Cross spacing jumpers 3 poles 32 A (IEC)	Orange <input checked="" type="checkbox"/>	JB85-3	1SNK900603R0000	10	2.80	
5 Circuit separators 3 mm 0.118 in	Dark grey <input checked="" type="checkbox"/>	CS-R3	1SNK900107R0000	20	6.40	
6 Test adapters	Dark grey <input checked="" type="checkbox"/>	For test plugs DIA 2 mm 0.079 in	TP2	1SNK900203R0000	20	1.70
		For test plugs DIA 4 mm 0.157 in	TP4	1SNK900205R0000	20	2.40
7 Test connectors	Dark grey <input checked="" type="checkbox"/>	TC5-R1	1SNK900201R0000	10	5.20	
8 Spacers 0.8 mm 0.031 in	Dark grey <input checked="" type="checkbox"/>	ES-TC6	1SNK900105R0000	10	0.80	
9 Coding pegs	Dark grey <input checked="" type="checkbox"/>	COP-ZD	1SNK900636R0000	10	3.57	
10 Terminal block markers	White <input type="checkbox"/>	Blank marker	MG-CPM 13 41791	1SNB041791R0612	1680	0.27
		Blank card	MC612	1SNK150000R0000	22	10.00
			MC612PA	1SNK159999R0000	20	11.00
	Grey <input type="checkbox"/>	Universal wire markers holder	UMH	1SNK900611R0000	10	0.20

Complete list of accessories is indicated in the terminal block datasheet including end stops.

Some accessories such as jumper bars may modify the terminal block's ratings: Complete information available in the accessories section of the catalog.

Technical data valid for copper conductors only.

ZDK2.5-11-PE PI-Spring pluggable terminal blocks

Ground - 5.2 mm 0.205 in spacing



1SNK164019K0014

ZDK2.5-11-PE

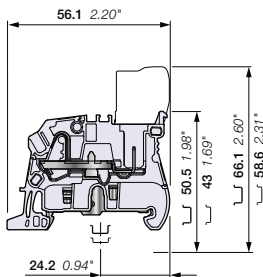

5.2 mm 0.205 in spacing

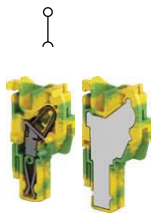

CDK2.5-PE CDK2.5-PE-E

Available in Q3.2019

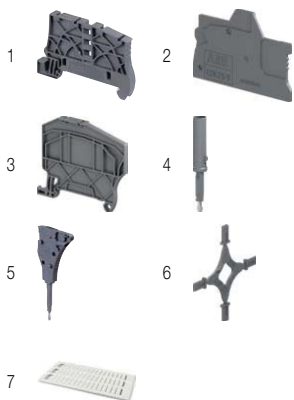

Description

- Increase your productivity with pluggable terminal blocks: possibility of pre-produced plugs harnesses, time saving plug and play assembly, reduced transportation panels preparation and final installation, easily connect sub-assemblies together,
- Simplify and secure your installation: in site faulty connection errors are eliminated, prior connection testing is eased and reliable, test connectors (TC5) withstanding 10 000 operations are compatible for convenient testing.

Ordering details

Description	Color	Type	Part Number	Pkg qty	Weight (1 pce) g
Ground 2 connections	Green-yellow	ZDK2.5-11-PE	1SNK805150R0000	50	9.62

Main technical data

Connecting capacity	IEC	UL - CSA	Mounting instructions
1 conductor per clamp	Rigid: Solid/Stranded	0.2 ... 4 mm²	26 ... 12 AWG
	Flexible without ferrule	0.22 ... 2.5 mm²	26 ... 14 AWG
	Flexible with non insulated ferrule	0.22 ... 2.5 mm²	26 ... 14 AWG
	Flexible with insulated ferrule	0.22 ... 2.5 mm²	26 ... 14 AWG
Rated cross section	2.5 mm²	12 AWG	
Rated short-time withstand current (1s)	300 A	396 A	
Protection	IP20	NEMA 1	

The connecting capacity data for one Rigid: Solid/Stranded, or one Flexible conductor (when applicable) is a mandatory information required by IEC, UL and CSA standards (Copper conductors). All other data are provided as supplementary information only. For more details, please consult our CB, UL or CSA certificates and technical datasheet available on <http://www.TE.com>

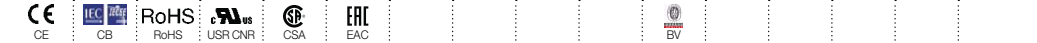

Female plugs

Description	Color	Type	Part Number	Pkg qty	Weight (1 pce) g
Female plugs 1 pole	Green-yellow	CDK2.5-PE	1SNK805750R0000	50	2.80
Female plugs without outer nubs - Closed 15 poles max.		CDK2.5-PE-E	1SNK805753R0000	50	2.88

Accessories

Description	Color	Type	Part Number	Pkg qty	Weight (1 pce) g	
1 End stops 5.2 mm 0.205 in	Dark grey	BAZ1	1SNK900002R0000	50	5.30	
2 End sections 1.5 mm 0.059 in	Dark grey	EDK2.5-11	1SNK805915R0000	20	1.49	
3 Circuit separators 3 mm 0.118 in	Dark grey	CS-R2	1SNK900106R0000	20	3.80	
4 Test adapters	Dark grey	For test plugs DIA 2 mm 0.079 in	TP2	1SNK900203R0000	20	1.70
		For test plugs DIA 4 mm 0.157 in	TP4	1SNK900205R0000	20	2.40
5 Test connectors 5.2 mm 0.205 in spacing	Dark grey	End module, 5.2 mm 0.205 in	TC5	1SNK900200R0000	10	5.20
			TC5-R1	1SNK900201R0000	10	5.20
6 Coding pegs	Dark grey	COP-ZD	1SNK900636R0000	10	3.57	
7 Terminal block markers	White	Blank card	MC512	1SNK140000R0000	22	9.00
		Blank marker	MC512PA	1SNK149999R0000	20	10.00
			MG-CPM 13 41790	1SNB041790R0512	1960	0.236
		Universal wire markers holder	UMH	1SNK900611R0000	10	0.20

Complete list of accessories is indicated in the terminal block datasheet including end stops. Some accessories such as jumper bars may modify the terminal block's ratings: Complete information available in the accessories section of the catalog.

Technical data valid for copper conductors only.

1SNK164024S0201

ZDK2.5-22-PE PI-Spring pluggable terminal blocks

Feed-through - 5.2 mm 0.205 in spacing



2.5 mm²

12 AWG



1SNK16402200014

ZDK2.5-22-PE

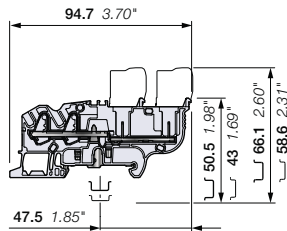

5.2 mm 0.205 in spacing

Description

- Increase your productivity with pluggable terminal blocks: possibility of pre-produced plugs harnesses, time saving plug and play assembly, reduced transportation panels preparation and final installation, easily connect sub-assemblies together,
- Simplify and secure your installation: in site faulty connection errors are eliminated, prior connection testing is eased and reliable, test connectors (TC5) withstanding 10 000 operations are compatible for convenient testing.

Ordering details

Description	Color	Type	Part Number	Pkg qty	Weight (1 pce) g
Ground 4 connections	Green-yellow	ZDK2.5-22-PE	1SNK805152R0000	50	14.05

Main technical data

Connecting capacity	IEC	UL - CSA	Mounting instructions		
1 conductor per clamp	Rigid: Solid/Stranded	0.2 ... 4 mm ²	26 ... 12 AWG	Rail	TH 35-7.5, TH 35-15
	Flexible without ferrule	0.22 ... 2.5 mm ²	26 ... 14 AWG	Wire stripping length	11 mm 0.433 in
	Flexible with non insulated ferrule	0.22 ... 2.5 mm ²	26 ... 14 AWG		Tool (for flexible conductor without ferrule)
	Flexible with insulated ferrule	0.22 ... 2.5 mm ²	26 ... 14 AWG		
Rated cross section	2.5 mm ²	12 AWG			
Rated short-time withstand current (1s)	300 A	396 A			
Protection	IP20	NEMA 1			

The connecting capacity data for one Rigid: Solid/Stranded, or one Flexible conductor (when applicable) is a mandatory information required by IEC, UL and CSA standards (Copper conductors). All other data are provided as supplementary information only. For more details, please consult our CB, UL or CSA certificates and technical datasheet available on <http://www.TE.com>

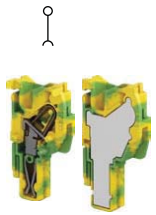

Available in Q3.2019

CDK2.5-PE CDK2.5-PE-E

Female plugs

Description	Color	Type	Part Number	Pkg qty	Weight (1 pce) g
Female plugs 1 pole	Green-yellow	CDK2.5-PE	1SNK805750R0000	50	2.80
Female plugs without outer nubs - Closed 15 poles max.		CDK2.5-PE-E	1SNK805753R0000	50	2.88

Accessories

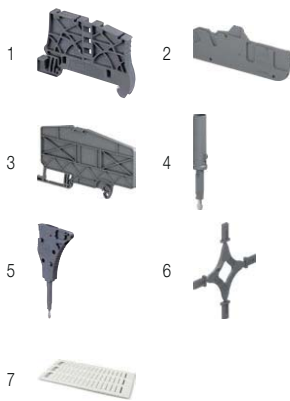

Description	Color	Type	Part Number	Pkg qty	Weight (1 pce) g	
1 End stops 5.2 mm 0.205 in	Dark grey	BAZ1	1SNK900002R0000	50	5.30	
2 End sections 2.2 mm 0.087 in	Dark grey	EDK2.5-22	1SNK805910R0000	20	3.15	
3 Circuit separators 3 mm 0.118 in	Dark grey	CS-R3	1SNK900107R0000	20	6.40	
4 Test adapters	Dark grey	For test plugs DIA 2 mm 0.079 in	TP2	1SNK900203R0000	20	1.70
		For test plugs DIA 4 mm 0.157 in	TP4	1SNK900205R0000	20	2.40
5 Test connectors 5.2 mm 0.205 in spacing	Dark grey	End module, 5.2 mm 0.205 in	TC5	1SNK900200R0000	10	5.20
			TC5-R1	1SNK900201R0000	10	5.20
6 Coding pegs	Dark grey	COP-ZD	1SNK900636R0000	10	3.57	
7 Terminal block markers	White	Blank card	MC512	1SNK140000R0000	22	9.00
		Blank marker	MC512PA	1SNK149999R0000	20	10.00
			MG-CPM 13 41790	1SNB041790R0512	1960	0.236
		Universal wire markers holder	Grey	UMH	1SNK900611R0000	10

Complete list of accessories is indicated in the terminal block datasheet including end stops. Some accessories such as jumper bars may modify the terminal block's ratings: Complete information available in the accessories section of the catalog.

Technical data valid for copper conductors only.

ZDK2.5-D2 PI-Spring pluggable terminal blocks

Double deck feed-through 2 circuits - 5.2 mm 0.205 in spacing

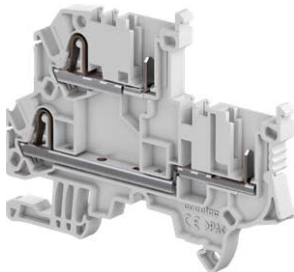

1SNK16402300014

ZDK2.5-D2

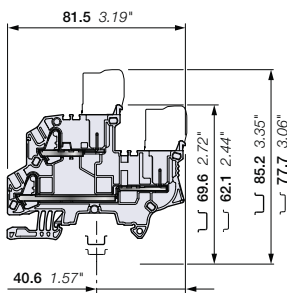

5.2 mm 0.205 in spacing

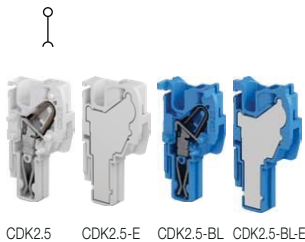

CDK2.5 CDK2.5-E CDK2.5-BL CDK2.5-BL-E

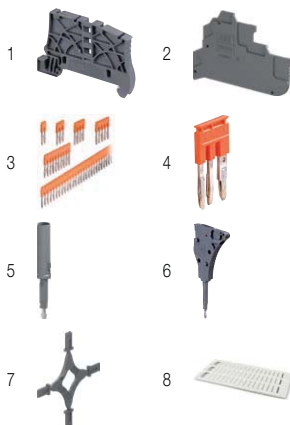

Description

- Increase your productivity with pluggable terminal blocks: possibility of pre-produced plugs harnesses, time saving plug and play assembly, reduced transportation panels preparation and final installation, easily connect sub-assemblies together,
- Simplify and secure your installation: in site faulty connection errors are eliminated, prior connection testing is eased and reliable, test connectors (TC5) withstanding 10 000 operations are compatible for convenient testing.

Ordering details

Description	Color	Type	Part Number	Pkg qty	Weight (1 pce) g
Feed-through double deck 4 connections	Grey <input type="checkbox"/>	ZDK2.5-D2	1SNK805213R0000	50	11.89
	Blue <input type="checkbox"/>	ZDK2.5-D2-BL	1SNK805223R0000	50	11.89

Main technical data

Connecting capacity	IEC	UL - CSA	Mounting instructions
1 conductor per clamp	Rigid: Solid/Stranded	0.2 ... 4 mm ²	26 ... 12 AWG
	Flexible without ferrule	0.22 ... 2.5 mm ²	26 ... 14 AWG
	Flexible with non insulated ferrule	0.22 ... 2.5 mm ²	26 ... 14 AWG
	Flexible with insulated ferrule	0.22 ... 2.5 mm ²	26 ... 14 AWG
2 conductors per clamp	Flexible with twin ferrule	0.22 ... 0.5 mm ²	26 ... 20 AWG
Rated current / Rated cross section	22 A / 2.5 mm ²	20 A / 12 AWG	
Rated short-time withstand current (1s)	300 A		
Rated voltage	800 V	600 V	
Impulse withstand voltage	8000 V		
Protection	IP20	NEMA 1	

The connecting capacity data for one Rigid: Solid/Stranded, or one Flexible conductor (when applicable) is a mandatory information required by IEC, UL and CSA standards (Copper conductors). All other data are provided as supplementary information only. For more details, please consult our CB, UL or CSA certificates and technical datasheet available on <http://www.TE.com>

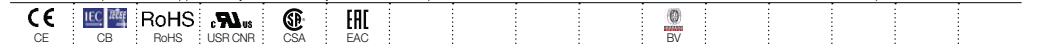

Female plugs

Description	Color	Type	Part Number	Pkg qty	Weight (1 pce) g
Female plugs 1 pole	Grey <input type="checkbox"/>	CDK2.5	1SNK805712R0000	50	2.80
Female plugs without outer nubs - Closed		CDK2.5-E	1SNK805713R0000	50	2.88
Female plugs 1 pole	Blue <input type="checkbox"/>	CDK2.5-BL	1SNK805742R0000	50	2.80
Female plugs without outer nubs - Closed		CDK2.5-BL-E	1SNK805743R0000	50	2.88

15 poles max.

Accessories

Description	Color	Type	Part Number	Pkg qty	Weight (1 pce) g	
1 End stops 5.2 mm 0.205 in	Dark grey <input type="checkbox"/>	BAZ1	1SNK900002R0000	50	5.30	
2 End sections 2.0 mm 0.079 in	Dark grey <input type="checkbox"/>	EDK2.5-D	1SNK805913R0000	20	3.88	
3 Jumper bars	Orange <input type="checkbox"/>	2 poles 32 A (IEC)	JB5-2	1SNK905302R0000	50	1.30
		3 poles 32 A (IEC)	JB5-3	1SNK905303R0000	50	2.00
		4 poles 32 A (IEC)	JB5-4	1SNK905304R0000	50	2.70
		5 poles 32 A (IEC)	JB5-5	1SNK905305R0000	50	3.50
		10 poles 32 A (IEC)	JB5-10	1SNK905310R0000	30	7.10
		50 poles 32 A (IEC)	JB5-50	1SNK905350R0000	10	36.00
4 Cross spacing jumpers 3 poles 32 A (IEC)	Orange <input type="checkbox"/>	JB85-3	1SNK900603R0000	10	2.80	
5 Test adapters	Dark grey <input type="checkbox"/>	For test plugs DIA 2 mm 0.079 in	TP2	1SNK900203R0000	20	1.70
		For test plugs DIA 4 mm 0.157 in	TP4	1SNK900205R0000	20	2.40
6 Test connectors	Dark grey <input type="checkbox"/>	5.2 mm 0.205 in spacing	TC5	1SNK900200R0000	10	5.20
		End module, 5.2 mm 0.205 in	TC5-R1	1SNK900201R0000	10	5.20
7 Coding pegs	Dark grey <input type="checkbox"/>	COP-ZD	1SNK900636R0000	10	3.57	
		MC512	1SNK140000R0000	22	9.00	
		MC512PA	1SNK149999R0000	20	10.00	
		MG-CPM 13 41790	1SNB041790R0512	1960	0.236	
8 Terminal block markers	White <input type="checkbox"/>	Blank card				
		Blank marker				
	Grey <input type="checkbox"/>	UMH	1SNK900611R0000	10	0.20	

Complete list of accessories is indicated in the terminal block datasheet including end stops.

Some accessories such as jumper bars may modify the terminal block's ratings: Complete information available in the accessories section of the catalog.

Technical data valid for copper conductors only.

1SNK16402300014

ZDK2.5-D1 PI-Spring pluggable terminal blocks

Double deck feed-through 1 circuit - 5.2 mm 0.205 in spacing

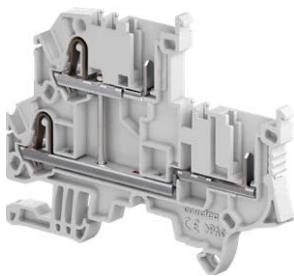

1SNK16425V0014

ZDK2.5-D1

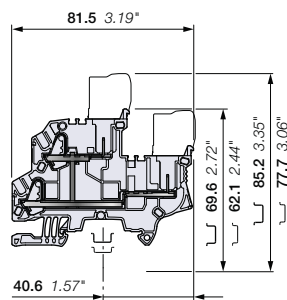

5.2 mm 0.205 in spacing



CDK2.5 CDK2.5-E

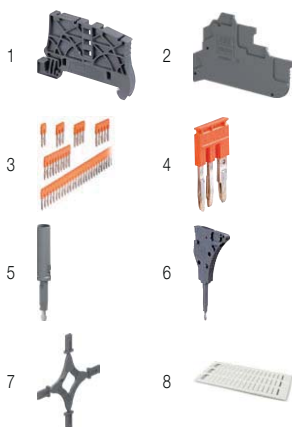

Description

- Increase your productivity with pluggable terminal blocks: possibility of pre-produced plugs harnesses, time saving plug and play assembly, reduced transportation panels preparation and final installation, easily connect sub-assemblies together,
- Simplify and secure your installation: in site faulty connection errors are eliminated, prior connection testing is eased and reliable, test connectors (TC5) withstanding 10 000 operations are compatible for convenient testing.

Ordering details

Description	Color	Type	Part Number	Pkg qty	Weight (1 pce) g
Feed-through double deck 4 connections	Grey <input type="checkbox"/>	ZDK2.5-D1	1SNK805214R0000	50	12.46

Main technical data

Connecting capacity	IEC	UL - CSA	Rail	TH 35-7.5, TH 35-15
1 conductor per clamp	Rigid: Solid/Stranded	0.2 ... 4 mm ²	26 ... 12 AWG	
	Flexible without ferrule	0.22 ... 2.5 mm ²		11 mm 0.433 in
	Flexible with non insulated ferrule	0.22 ... 2.5 mm ²	26 ... 14 AWG	
	Flexible with insulated ferrule	0.22 ... 2.5 mm ²	26 ... 14 AWG	
2 conductors per clamp	Flexible with twin ferrule	0.22 ... 0.5 mm ²	26 ... 20 AWG	
Rated current / Rated cross section	22 A / 2.5 mm ²	20 A / 12 AWG		
Rated short-time withstand current (1s)	300 A			
Rated voltage	800 V	600 V		
Impulse withstand voltage	8000 V			
Protection	IP20	NEMA 1		

Mounting instructions

Wire stripping length	Tool (for flexible conductor without ferrule)	Flat screwdriver
		Ø 3.5 mm Ø 0.138 in

The connecting capacity data for one Rigid: Solid/Stranded, or one Flexible conductor (when applicable) is a mandatory information required by IEC, UL and CSA standards (Copper conductors). All other data are provided as supplementary information only. For more details, please consult our CB, UL or CSA certificates and technical datasheet available on <http://www.TE.com>

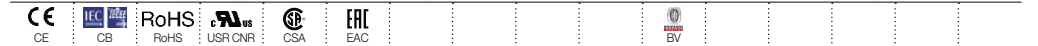

Female plugs

Description	Color	Type	Part Number	Pkg qty	Weight (1 pce) g
Female plugs 1 pole	Grey	<input type="checkbox"/> CDK2.5	1SNK805712R0000	50	2.80
Female plugs without outer nubs - Closed 15 poles max.		<input type="checkbox"/> CDK2.5-E	1SNK805713R0000	50	2.88

Accessories

Description	Color	Type	Part Number	Pkg qty	Weight (1 pce) g	
1 End stops 5.2 mm 0.205 in	Dark grey <input type="checkbox"/>	BAZ1	1SNK900002R0000	50	5.30	
2 End sections 2.0 mm 0.079 in	Dark grey <input type="checkbox"/>	EDK2.5-D	1SNK805913R0000	20	3.88	
3 Jumper bars 2 poles 32 A (IEC)	Orange <input type="checkbox"/>	JB5-2	1SNK905302R0000	50	1.30	
		3 poles 32 A (IEC)	JB5-3	1SNK905303R0000	50	2.00
		4 poles 32 A (IEC)	JB5-4	1SNK905304R0000	50	2.70
		5 poles 32 A (IEC)	JB5-5	1SNK905305R0000	50	3.50
		10 poles 32 A (IEC)	JB5-10	1SNK905310R0000	30	7.10
		50 poles 32 A (IEC)	JB5-50	1SNK905350R0000	10	36.00
4 Cross spacing jumpers 3 poles 32 A (IEC)	Orange <input type="checkbox"/>	JB85-3	1SNK900603R0000	10	2.80	
5 Test adapters For test plugs DIA 2 mm 0.079 in For test plugs DIA 4 mm 0.157 in	Dark grey <input type="checkbox"/>	TP2	1SNK900203R0000	20	1.70	
		TP4	1SNK900205R0000	20	2.40	
6 Test connectors 5.2 mm 0.205 in spacing End module, 5.2 mm 0.205 in	Dark grey <input type="checkbox"/>	TC5	1SNK900200R0000	10	5.20	
		TC5-R1	1SNK900201R0000	10	5.20	
7 Coding pegs	Dark grey <input type="checkbox"/>	COP-ZD	1SNK900636R0000	10	3.57	
		MC512	1SNK140000R0000	22	9.00	
		MC512PA	1SNK149999R0000	20	10.00	
8 Terminal block markers	White <input type="checkbox"/>	MG-CPM 13 41790	1SNB041790R0512	1960	0.236	
		Universal wire markers holder	Grey <input type="checkbox"/>	UMH	1SNK900611R0000	10

Complete list of accessories is indicated in the terminal block datasheet including end stops. Some accessories such as jumper bars may modify the terminal block's ratings: Complete information available in the accessories section of the catalog.

Technical data valid for copper conductors only.

ZDK2.5-D2-PE PI-Spring pluggable terminal blocks

Double deck feed-through + ground - 5.2 mm 0.205 in spacing

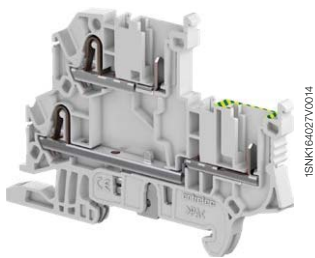

ZDK2.5-D2-PE

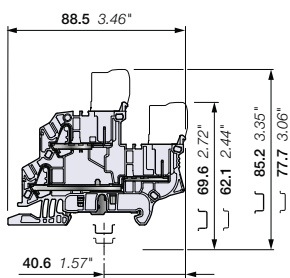

5.2 mm 0.205 in spacing

Available in Q3.2019

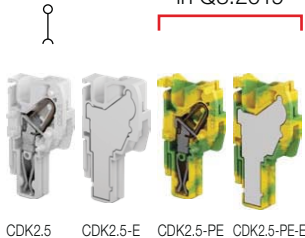

CDK2.5 CDK2.5-E CDK2.5-PE CDK2.5-PE-E



1 2 3 4 5 6 7 8

Description

- Increase your productivity with pluggable terminal blocks: possibility of pre-produced plugs harnesses, time saving plug and play assembly, reduced transportation panels preparation and final installation, easily connect sub-assemblies together,
- Simplify and secure your installation: in site faulty connection errors are eliminated, prior connection testing is eased and reliable, test connectors (TC5) withstanding 10 000 operations are compatible for convenient testing.

Ordering details

Description	Color	Type	Part Number	Pkg qty	Weight (1 pce) g
Feed-through + ground	double deck 4 connections	Grey, Green-yellow	ZDK2.5-D2-PE	1SNK805212R0000	50 16.13

Main technical data

Connecting capacity	IEC	UL - CSA	Mounting instructions		
1 conductor per clamp	Rigid: Solid/Stranded	0.2 ... 4 mm ²	26 ... 12 AWG	Rail	TH 35-7.5, TH 35-15
	Flexible without ferrule	0.22 ... 2.5 mm ²	26 ... 14 AWG	Wire stripping length	11 mm 0.433 in
	Flexible with non insulated ferrule	0.22 ... 2.5 mm ²	26 ... 14 AWG		
	Flexible with insulated ferrule	0.22 ... 2.5 mm ²	26 ... 14 AWG		
2 conductors per clamp	Flexible with twin ferrule	0.22 ... 0.5 mm ²	26 ... 20 AWG	Tool (for flexible conductor without ferrule)	Flat screwdriver Ø 3.5 mm Ø 0.138 in
Rated current / Rated cross section	22 A / 2.5 mm ²	20 A / 12 AWG			
Rated short-time withstand current (1s)	300 A	396 A			
Rated voltage	800 V	600 V			
Impulse withstand voltage	8000 V				
Protection	IP20	NEMA 1			

The connecting capacity data for one Rigid: Solid/Stranded, or one Flexible conductor (when applicable) is a mandatory information required by IEC, UL and CSA standards (Copper conductors). All other data are provided as supplementary information only. For more details, please consult our CB, UL or CSA certificates and technical datasheet available on <http://www.TE.com>

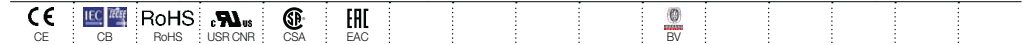

Female plugs

Description	Color	Type	Part Number	Pkg qty	Weight (1 pce) g
Female plugs	1 pole	Grey	CDK2.5	1SNK805712R0000	50 2.80
Female plugs without outer nubs - Closed	1 pole		CDK2.5-E	1SNK805713R0000	50 2.88
Female plugs	1 pole	Green-yellow	CDK2.5-PE	1SNK805750R0000	50 2.80
Female plugs without outer nubs - Closed	1 pole		CDK2.5-PE-E	1SNK805753R0000	50 2.88

15 poles max.

Accessories

Description	Color	Type	Part Number	Pkg qty	Weight (1 pce) g
1 End stops	5.2 mm 0.205 in	Dark grey	BAZ1	1SNK900002R0000	50 5.30
2 End sections	2.0 mm 0.079 in	Dark grey	EDK2.5-D	1SNK805913R0000	20 3.88
3 Jumper bars	2 poles 32 A (IEC)	Orange	JB5-2	1SNK905302R0000	50 1.30
	3 poles 32 A (IEC)		JB5-3	1SNK905303R0000	50 2.00
	4 poles 32 A (IEC)		JB5-4	1SNK905304R0000	50 2.70
	5 poles 32 A (IEC)		JB5-5	1SNK905305R0000	50 3.50
	10 poles 32 A (IEC)		JB5-10	1SNK905310R0000	30 7.10
	50 poles 32 A (IEC)		JB5-50	1SNK905350R0000	10 36.00
4 Cross spacing jumpers	3 poles 32 A (IEC)	Orange	JB85-3	1SNK900603R0000	10 2.80
5 Test adapters	For test plugs DIA 2 mm 0.079 in	Dark grey	TP2	1SNK900203R0000	20 1.70
	For test plugs DIA 4 mm 0.157 in		TP4	1SNK900205R0000	20 2.40
6 Test connectors	5.2 mm 0.205 in spacing	Dark grey	TC5	1SNK900200R0000	10 5.20
	End module, 5.2 mm 0.205 in		TC5-R1	1SNK900201R0000	10 5.20
7 Coding pegs		Dark grey	COP-ZD	1SNK900636R0000	10 3.57
		White	MC512	1SNK140000R0000	22 9.00
			MC512PA	1SNK149999R0000	20 10.00
			MG-CPM 13 41790	1SNB041790R0512	1960 0.236
8 Terminal block markers	Blank card				
	Blank marker	Grey	UMH	1SNK900611R0000	10 0.20

Complete list of accessories is indicated in the terminal block datasheet including end stops. Some accessories such as jumper bars may modify the terminal block's ratings: Complete information available in the accessories section of the catalog.

Technical data valid for copper conductors only.

ZDK2.5-D1-PE PI-Spring pluggable terminal blocks

Double deck ground - 5.2 mm 0.205 in spacing



2.5 mm²

12 AWG

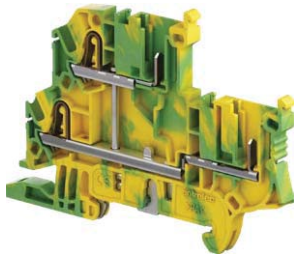

1SNK16402B0004

ZDK2.5-D1-PE

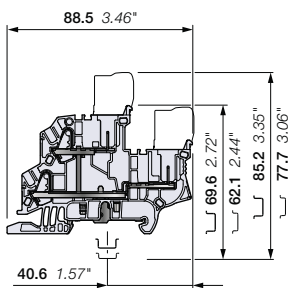

5.2 mm 0.205 in spacing



CDK2.5-PE CDK2.5-PE-E

Available in Q3.2019

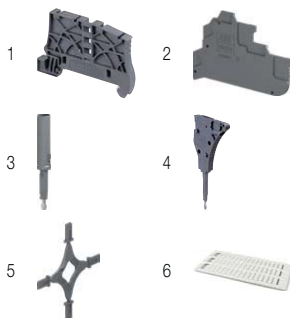

Description

- Increase your productivity with pluggable terminal blocks: possibility of pre-produced plugs harnesses, time saving plug and play assembly, reduced transportation panels preparation and final installation, easily connect sub-assemblies together,
- Simplify and secure your installation: in site faulty connection errors are eliminated, prior connection testing is eased and reliable, test connectors (TC5) withstanding 10 000 operations are compatible for convenient testing.

Ordering details

Description	Color	Type	Part Number	Pkg qty	Weight (1 pce) g
Ground double deck 4 connections	Green-yellow	ZDK2.5-D1-PE	1SNK805250R0000	50	16.80

Main technical data

Connecting capacity	IEC	UL - CSA	Mounting instructions		
1 conductor per clamp	Rigid: Solid/Stranded	0.2 ... 4 mm ²	26 ... 12 AWG	Rail	TH 35-7.5, TH 35-15
	Flexible without ferrule	0.22 ... 2.5 mm ²	26 ... 14 AWG	Wire stripping length	11 mm 0.433 in
	Flexible with non insulated ferrule	0.22 ... 2.5 mm ²	26 ... 14 AWG		Tool (for flexible conductor without ferrule)
	Flexible with insulated ferrule	0.22 ... 2.5 mm ²	26 ... 14 AWG		
Rated cross section	2.5 mm ²	12 AWG			
Rated short-time withstand current (1s)	300 A	396 A			
Protection	IP20	NEMA 1			

The connecting capacity data for one Rigid: Solid/Stranded, or one Flexible conductor (when applicable) is a mandatory information required by IEC, UL and CSA standards (Copper conductors). All other data are provided as supplementary information only. For more details, please consult our CB, UL or CSA certificates and technical datasheet available on <http://www.TE.com>

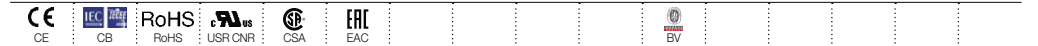

Female plugs

Description	Color	Type	Part Number	Pkg qty	Weight (1 pce) g
Female plugs 1 pole	Green-yellow	CDK2.5-PE	1SNK805750R0000	50	2.80
Female plugs without outer nubs - Closed 15 poles max.		CDK2.5-PE-E	1SNK805753R0000	50	2.88

Accessories

Description	Color	Type	Part Number	Pkg qty	Weight (1 pce) g	
1 End stops 5.2 mm 0.205 in	Dark grey	BAZ1	1SNK900002R0000	50	5.30	
2 End sections 2.0 mm 0.079 in	Dark grey	EDK2.5-D	1SNK805913R0000	20	3.88	
3 Test adapters	Dark grey	For test plugs DIA 2 mm 0.079 in	TP2	1SNK900203R0000	20	1.70
		For test plugs DIA 4 mm 0.157 in	TP4	1SNK900205R0000	20	2.40
4 Test connectors 5.2 mm 0.205 in spacing	Dark grey	End module, 5.2 mm 0.205 in	TC5	1SNK900200R0000	10	5.20
			TC5-R1	1SNK900201R0000	10	5.20
5 Coding pegs	Dark grey	COP-ZD	1SNK900636R0000	10	3.57	
6 Terminal block markers	White	MC512	1SNK140000R0000	22	9.00	
	Grey	MC512PA	1SNK149999R0000	20	10.00	
	Grey	UMH	1SNK900611R0000	10	0.20	

Complete list of accessories is indicated in the terminal block datasheet including end stops.

Some accessories such as jumper bars may modify the terminal block's ratings: Complete information available in the accessories section of the catalog.

Technical data valid for copper conductors only.

CDK2.5 PI-Spring female plugs

Female plug - 5.2 mm 0.205 in spacing

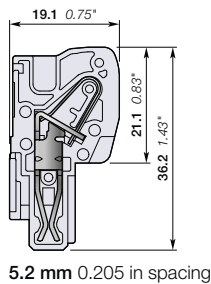
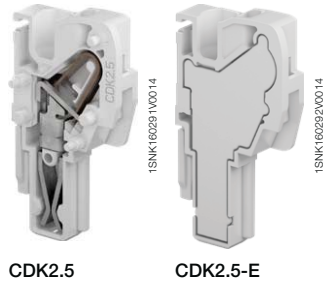

Description

- Create your own female plug assemblies without any special tools, easily snap together multiple plugs for optimal ergonomics and quick assembly,
- Increase your flexibility: eliminate stock of pre-configured female plugs, easily add an extra plug in case of needed modification,
- Reduce your stock of unitary plugs up to 30%: only two plug variants are required to compose your own subsets of plugs from 2 to 15 poles.

Ordering details

Description	Color	Type	Part number	Pkg qty	Weight (1 pce) g
Female plugs	Grey	CDK2.5	1SNK805712R0000	50	2.80
	Blue	CDK2.5-BL	1SNK805742R0000	50	2.80
	Green-Yellow	CDK2.5-PE	1SNK805750R0000	50	2.80
Female plugs without outer nubs - Closed	Grey	CDK2.5-E	1SNK805713R0000	50	2.80
	Blue	CDK2.5-BL-E	1SNK805743R0000	50	2.80
	Green-Yellow	CDK2.5-PE-E	1SNK805753R0000	50	2.80

Main technical data

Connecting capacity		IEC	UL - CSA	Mounting instructions	
1 conductor per clamp	Rigid: Solid/Stranded	0.2 ... 4 mm²	26 ... 12 AWG	Rail	
	Flexible without ferrule	0.22 ... 2.5 mm²		Wire stripping length	11 mm 0.433 in
	Flexible with non insulated ferrule	0.22 ... 2.5 mm²	26 ... 14 AWG	Tool (for flexible conductor without ferrule)	Flat screwdriver Ø 3.5 mm Ø 0.138 in
	Flexible with insulated ferrule	0.22 ... 2.5 mm²	26 ... 14 AWG		
2 conductors per clamp	Flexible with twin ferrule	0.22 ... 0.5 mm²	26 ... 20 AWG		
Rated current / Rated cross section		24 A / 2.5 mm²	22 A / 12 AWG		
Rated short-time withstand current (1s)		300 A			
Rated voltage		1000 V	600 V		
Impulse withstand voltage		8000 V			
Protection		IP20	NEMA 1		

The connecting capacity data for one Rigid: Solid/Stranded, or one Flexible conductor (when applicable) is a mandatory information required by IEC, UL and CSA standards (Copper conductors). All other data are provided as supplementary information only. For more details, please consult our CB, UL or CSA certificates and technical datasheet available on <http://www.TE.com>

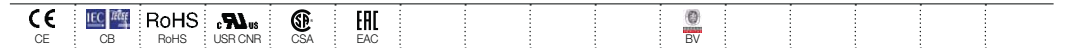

Mounting instructions

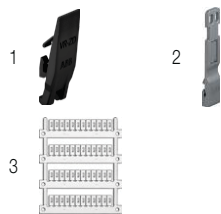

Accessories

Description	Color	Type	Part number	Pkg qty	Weight (1 pce) g
1 Locking devices	Black	VR-ZD	1SNK900637R0000	50	0.7
2 Cable clamp	Dark grey	PT-ZD	1SNK900660R0000	50	1.04
3 Terminal block markers	White	MG-CPM 13 41790	1SNB041790R0512	1960	0.23
		MG-CPMFA 43196	1SNB043196R0012	350	2.56
		MC512	1SNK140000R0000	22	9.00
	MC512PA	1SNK149999R0000	20	10.00	
	Universal wire markers holder	Grey	UMH	1SNK900611R0000	10

Complete list of accessories is indicated in the terminal block datasheet including end stops. Some accessories such as jumper bars may modify the terminal block's ratings: Complete information available in the accessories section of the catalog.

Technical data valid for copper conductors only.

CDK2.5-J PI-Spring female plugs

Female plug - 5.2 mm 0.205 in spacing

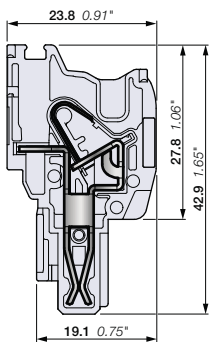
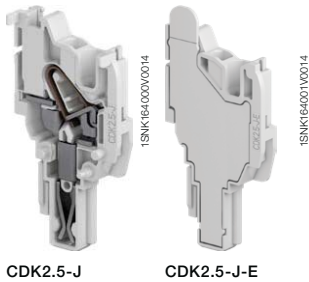

5.2 mm 0.205 in spacing

Description

- Create your own female plug assemblies without any special tools, easily snap together multiple plugs for optimal ergonomics and quick assembly,
- Increase your flexibility: eliminate stock of pre-configured female plugs, easily add an extra plug in case of needed modification,
- Reduce your stock of unitary plugs up to 30%: only two plug variants are required to compose your own subsets of plugs from 2 to 15 poles.

Description	Color	Type	Part Number	Pkg qty	Weight (1 pce)
Female plugs	Grey	CDK2.5-J	1SNK805738R0000	50	4.08
	Blue	CDK2.5-J-BL	1SNK805744R0000	50	4.08
	Green-yellow	CDK2.5-J-PE	1SNK805748R0000	50	4.08
Female plugs without outer nubs - Closed	Grey	CDK2.5-J-E	1SNK805739R0000	50	4.34
	Blue	CDK2.5-J-BL-E	1SNK805745R0000	50	4.34
	Green-yellow	CDK2.5-J-PE-E	1SNK805749R0000	50	4.34

Main technical data

Connecting capacity	IEC	UL - CSA	Mounting instructions
1 conductor per clamp	Rigid: Solid/Stranded	0.2 ... 4 mm ²	Rail Wire stripping length 11 mm 0.433 in
	Flexible without ferrule	0.22 ... 2.5 mm ²	
	Flexible with non insulated ferrule	0.22 ... 2.5 mm ²	
	Flexible with insulated ferrule	0.22 ... 2.5 mm ²	
2 conductors per clamp	Flexible with twin ferrule	0.22 ... 0.5 mm ²	Tool (for flexible conductor without ferrule) Flat screwdriver Ø 3.5 mm Ø 0.138 in
		26 ... 20 AWG	
Rated current / Rated cross section	24 A / 2.5 mm ²	20 A / 12 AWG	
Rated short-time withstand current (1s)	300 A		
Rated voltage	800 V	600 V	
Impulse withstand voltage	8000 V		
Protection	IP20	NEMA 1	

The connecting capacity data for one Rigid: Solid/Stranded, or one Flexible conductor (when applicable) is a mandatory information required by IEC, UL and CSA standards (Copper conductors). All other data are provided as supplementary information only. For more details, please consult our CB, UL or CSA certificates and technical datasheet available on <http://www.TE.com>



Mounting instructions

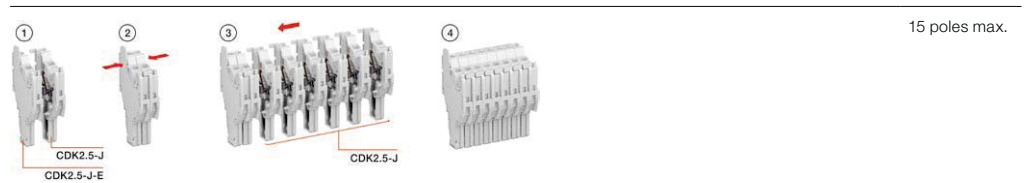

Accessories



Description	Color	Type	Part Number	Pkg qty	Weight (1 pce)
1 Jumper bars	Orange	2 poles 32 A (IEC)	JB5-2	1SNK905302R0000	50 1.30
		3 poles 32 A (IEC)	JB5-3	1SNK905303R0000	50 2.00
		4 poles 32 A (IEC)	JB5-4	1SNK905304R0000	50 2.70
		5 poles 32 A (IEC)	JB5-5	1SNK905305R0000	50 3.50
		10 poles 32 A (IEC)	JB5-10	1SNK905310R0000	30 7.10
		50 poles 32 A (IEC)	JB5-50	1SNK905350R0000	10 36.00
2 Test adapters	Dark grey	For test plugs DIA 2 mm 0.079 in	TP2	1SNK900203R0000	20 1.70
		For test plugs DIA 4 mm 0.157 in	TP4	1SNK900205R0000	20 2.40
3 Test connectors	Dark grey	5.2 mm 0.205 in spacing	TC5	1SNK900200R0000	10 5.20
		End module, 5.2 mm 0.205 in	TC5-R1	1SNK900201R0000	10 5.20
4 Locking devices	Black	VR-ZD	1SNK900637R0000	50 0.7	
5 Strain Relief	Dark grey	PT-ZD	1SNK900660R0000	50 1.04	
6 Terminal block markers	White	Blank card	MC512	1SNK140000R0000	22 9.00
			MC512PA	1SNK149999R0000	20 10.00
	Blank strip label	MG-CPMFA 43196	1SNB043196R0012	400 2.562	
	Blank marker	MG-CPM 13 41790	1SNB041790R0512	1960 0.236	
	Universal wire markers holder	Grey	UMH	1SNK900611R0000	10 0.20

Complete list of accessories is indicated in the terminal block datasheet including end stops.

Some accessories such as jumper bars may modify the terminal block's ratings: Complete information available in the accessories section of the catalog.

Technical data valid for copper conductors only.

CDK2.5-2P-J PI-Spring female plugs

Female plug - 5.2 mm 0.205 in spacing

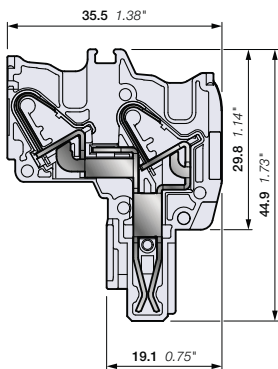
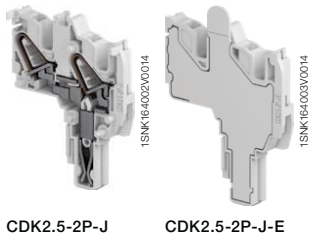

5.2 mm 0.205 in spacing

Description

- Create your own female plug assemblies without any special tools, easily snap together multiple plugs for optimal ergonomics and quick assembly,
- Increase your flexibility: eliminate stock of pre-configured female plugs, easily add an extra plug in case of needed modification,
- Reduce your stock of unitary plugs up to 30%: only two plug variants are required to compose your own subsets of plugs from 2 to 15 poles.

Description	Color	Type	Part Number	Pkg qty	Weight (1 pce) g
Female plugs	Grey	<input type="checkbox"/> CDK2.5-2P-J	1SNK805740R0000	50	5.37
	Blue	<input type="checkbox"/> CDK2.5-2P-J-BL	1SNK805746R0000	50	5.37
	Green-yellow	<input type="checkbox"/> CDK2.5-2P-J-PE	1SNK805751R0000	50	5.37
Female plugs without outer nubs - Closed	Grey	<input type="checkbox"/> CDK2.5-2P-J-E	1SNK805741R0000	50	5.74
	Blue	<input type="checkbox"/> CDK2.5-2P-J-BL-E	1SNK805747R0000	50	5.74
	Green-yellow	<input type="checkbox"/> CDK2.5-2P-J-PE-E	1SNK805752R0000	50	5.74

Main technical data

Connecting capacity	IEC	UL - CSA	Rail			
1 conductor per clamp	Rigid: Solid/Stranded	0.2 ... 4 mm ²	26 ... 12 AWG	Wire stripping length		11 mm 0.433 in
	Flexible without ferrule	0.22 ... 2.5 mm ²				
	Flexible with non insulated ferrule	0.22 ... 2.5 mm ²	26 ... 14 AWG			
	Flexible with insulated ferrule	0.22 ... 2.5 mm ²	26 ... 14 AWG			
2 conductors per clamp	Flexible with twin ferrule	0.22 ... 0.5 mm ²	26 ... 20 AWG	Tool (for flexible conductor without ferrule)		Flat screwdriver Ø 3.5 mm Ø 0.138 in
Rated current / Rated cross section		24 A / 2.5 mm ²	20 A / 12 AWG			
Rated short-time withstand current (1s)		300 A				
Rated voltage		500 V	600 V			
Impulse withstand voltage		6000 V				
Protection		IP20	NEMA 1			

Mounting instructions

The connecting capacity data for one Rigid: Solid/Stranded, or one Flexible conductor (when applicable) is a mandatory information required by IEC, UL and CSA standards (Copper conductors). All other data are provided as supplementary information only. For more details, please consult our CB, UL or CSA certificates and technical datasheet available on <http://www.TE.com>



Mounting instructions

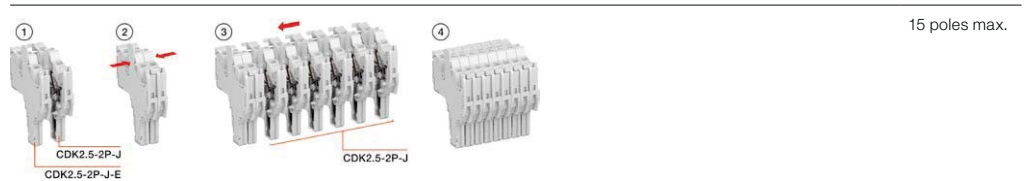

Accessories



Description	Color	Type	Part Number	Pkg qty	Weight (1 pce) g	
1 Jumper bars	Orange	2 poles 32 A (IEC)	JB5-2	1SNK905302R0000	50	1.30
		3 poles 32 A (IEC)	JB5-3	1SNK905303R0000	50	2.00
		4 poles 32 A (IEC)	JB5-4	1SNK905304R0000	50	2.70
		5 poles 32 A (IEC)	JB5-5	1SNK905305R0000	50	3.50
		10 poles 32 A (IEC)	JB5-10	1SNK905310R0000	30	7.10
		50 poles 32 A (IEC)	JB5-50	1SNK905350R0000	10	36.00
2 Test adapters	Dark grey	For test plugs DIA 2 mm 0.079 in	TP2	1SNK900203R0000	20	1.70
		For test plugs DIA 4 mm 0.157 in	TP4	1SNK900205R0000	20	2.40
3 Test connectors	Dark grey	5.2 mm 0.205 in spacing	TC5	1SNK900200R0000	10	5.20
		End module, 5.2 mm 0.205 in	TC5-R1	1SNK900201R0000	10	5.20
4 Locking devices	Black	VR-ZD	1SNK900637R0000	50	0.7	
5 Strain Relief	Dark grey	PT-ZD	1SNK900660R0000	50	1.04	
6 Terminal block markers	White	MC512	1SNK140000R0000	22	9.00	
		MC512PA	1SNK149999R0000	20	10.00	
	Blank strip label	MG-CPMFA 43196	1SNB043196R0012	400	2.562	
	Blank marker	MG-CPM 13 41790	1SNB041790R0512	1960	0.236	
	Universal wire markers holder	Grey	UMH	1SNK900611R0000	10	0.20

Complete list of accessories is indicated in the terminal block datasheet including end stops.

Some accessories such as jumper bars may modify the terminal block's ratings: Complete information available in the accessories section of the catalog.

Technical data valid for copper conductors only.

1SNK16403050201

CDK4 PI-Spring female plugs

Female plug - 6 mm 0.236 in spacing

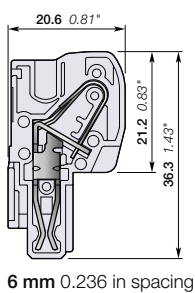
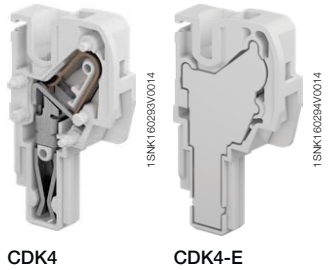

Description

- Create your own female plug assemblies without any special tools, easily snap together multiple plugs for optimal ergonomics and quick assembly,
- Increase your flexibility: eliminate stock of pre-configured female plugs, easily add an extra plug in case of needed modification,
- Reduce your stock of unitary plugs up to 30%: only two plug variants are required to compose your own subsets of plugs from 2 to 15 poles.

Ordering details

Description	Color	Type	Part Number	Pkg qty	Weight (1 pce) g
Female plugs	Grey <input type="checkbox"/>	CDK4	1SNK806712R0000	50	3.80
Female plugs without outer nubs - Closed		CDK4-E	1SNK806713R0000	50	4.50

Main technical data

Connecting capacity		IEC	UL - CSA	Mounting instructions	
1 conductor per clamp	Rigid: Solid/Stranded	0.5 ... 6 mm ²	26 ... 10 AWG	Wire stripping length	12.5 mm 0.492 in
	Flexible without ferrule	0.5 ... 4 mm ²			
	Flexible with non insulated ferrule	0.5 ... 4 mm ²	26 ... 12 AWG	Tool (for flexible conductor without ferrule)	Flat screwdriver Ø 3.5 mm Ø 0.138 in
	Flexible with insulated ferrule	0.5 ... 4 mm ²	26 ... 12 AWG		
2 conductors per clamp	Flexible with twin ferrule	0.5 ... 1 mm ²	26 ... 18 AWG		
Rated current / Rated cross section		30 A / 4 mm ²	30 A / 10 AWG		
Rated short-time withstand current (1s)		480 A			
Rated voltage		1000 V	600 V		
Impulse withstand voltage		8000 V			
Protection		IP20	NEMA 1		

The connecting capacity data for one Rigid: Solid/Stranded, or one Flexible conductor (when applicable) is a mandatory information required by IEC, UL and CSA standards (Copper conductors). All other data are provided as supplementary information only. For more details, please consult our CB, UL or CSA certificates and technical datasheet available on <http://www.TE.com>

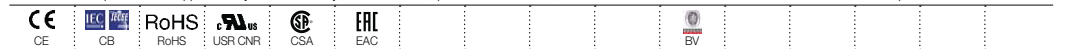

Mounting instructions



Accessories

Description	Color	Type	Part Number	Pkg qty	Weight (1 pce) g
1 Locking devices 9.4 mm 0.370 in spacing	Black <input checked="" type="checkbox"/>	VR-ZD	1SNK900637R0000	50	0.7
2 Cable Clamp 9.4 mm 0.370 in spacing	Dark grey <input checked="" type="checkbox"/>	PT-ZD	1SNK900660R0000	50	1.04
3 Terminal block markers	White <input type="checkbox"/>	MG-CPM 13 41791	1SNB041791R0612	1680	0.27
		MG-CPMFA 43196	1SNB043196R0012	350	2.56
		MC612	1SNK150000R0000	22	10.00
		MC612PA	1SNK159999R0000	20	11.00
	Universal wire markers holder	Grey <input type="checkbox"/>	UMH	1SNK900611R0000	10

Complete list of accessories is indicated in the terminal block datasheet including end stops. Some accessories such as jumper bars may modify the terminal block's ratings: Complete information available in the accessories section of the catalog.

Technical data valid for copper conductors only.

Screw clamp Pluggable

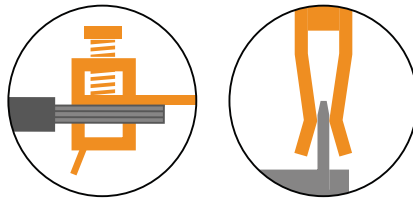

ZDS4-22 Screw clamp pluggable terminal blocks

Feed-through - 5.2 mm 0.205 in spacing

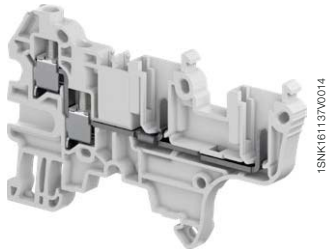

ZDS4-22

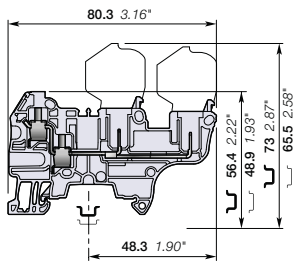

5.2 mm 0.205 in spacing

Description

- Increase your productivity with pluggable terminal blocks: possibility of pre-produced plugs harnesses, time saving plug and play assembly, reduced transportation panels preparation and final installation, easily connect sub-assemblies together,
- Simplify and secure your installation: in site faulty connection errors are eliminated, prior connection testing is eased and reliable, test connectors (TC5) withstanding 10 000 operations are compatible for convenient testing.

Ordering details

Description	Color	Type	Part Number	Pkg qty	Weight (1 pce) g
Feed-through 4 connections	Grey <input type="checkbox"/>	ZDS4-22	1SNK805013R0000	50	10.80

Main technical data

Connecting capacity		IEC	UL - CSA
1 conductor per clamp	Rigid: Solid/Stranded	0.2 ... 4 mm²	24 ... 10 AWG
	Flexible without ferrule	0.22 ... 4 mm²	24 ... 10 AWG
	Flexible with non insulated ferrule	0.22 ... 4 mm²	24 ... 10 AWG
	Flexible with insulated ferrule	0.22 ... 2.5 mm²	24 ... 12 AWG
	Gauge	A3-B3	
2 conductors per clamp	Rigid: Solid/Stranded	0.2 ... 1.5 mm²	24 ... 16 AWG
	Flexible without ferrule	0.22 ... 1.5 mm²	24 ... 16 AWG
	Flexible with twin ferrule	0.22 ... 1.5 mm²	24 ... 16 AWG
Rated current / Rated cross section		29 A / 4 mm²	28 A / 10 AWG
Rated short-time withstand current (1s)		480 A	
Rated voltage		800 V	300 V
Impulse withstand voltage		8000 V	
Protection		IP20	NEMA 1

Mounting instructions

Rail		TH 35-7.5, TH 35-15
Wire stripping length		10.5 mm 0.413 in
Tool		Flat screwdriver Ø 3.5 mm Ø 0.138 in
Torque		0.6 Nm ± 0.1 5.31 lb.in ± 0.885

The connecting capacity data for one Rigid: Solid/Stranded, or one Flexible conductor (when applicable) is a mandatory information required by IEC, UL and CSA standards (Copper conductors). All other data are provided as supplementary information only. For more details, please consult our CB, UL or CSA certificates and technical datasheet available on <http://www.TE.com>

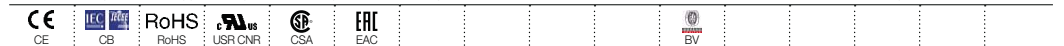

Female plugs

Description	Color	Type	Part Number	Pkg qty	Weight (1 pce) g
Female plugs 1 pole	Grey <input type="checkbox"/>	CDS4	1SNK805714R0000	50	3.90
Female plugs without outer nubs - Closed		CDS4-E	1SNK805715R0000	50	4.10

15 poles max.

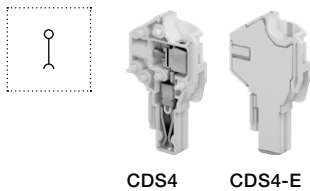

CDS4

CDS4-E

Accessories

Description	Color	Type	Part Number	Pkg qty	Weight (1 pce) g	
1 End stops 10 mm 0.394 in	Dark grey <input type="checkbox"/>	BAM4	1SNK900001R0000	50	14.00	
2 End sections 0.8 mm 0.031 in	Dark grey <input type="checkbox"/>	EDS4-22	1SNK805911R0000	20	1.85	
3 Jumper bars	Orange <input type="checkbox"/>	2 poles 32 A (IEC)	JB5-2	1SNK905302R0000	50	1.30
		3 poles 32 A (IEC)	JB5-3	1SNK905303R0000	50	2.00
		4 poles 32 A (IEC)	JB5-4	1SNK905304R0000	50	2.70
		5 poles 32 A (IEC)	JB5-5	1SNK905305R0000	50	3.50
		10 poles 32 A (IEC)	JB5-10	1SNK905310R0000	30	7.10
50 poles 32 A (IEC)		JB5-50	1SNK905350R0000	10	36.00	
4 Circuit separators 3 mm 0.118 in	Dark grey <input type="checkbox"/>	CS-R3	1SNK900107R0000	20	6.40	
5 Test adapters	Dark grey <input type="checkbox"/>	For test plugs DIA 2 mm 0.079 in	TP2	1SNK900203R0000	20	1.70
		For test plugs DIA 4 mm 0.157 in	TP4	1SNK900205R0000	20	2.40
6 Test connectors	Dark grey <input type="checkbox"/>	5.2 mm 0.205 in spacing	TC5	1SNK900200R0000	10	5.20
		End module, 5.2 mm 0.205 in	TC5-R1	1SNK900201R0000	10	5.20
7 Coding pegs	Dark grey <input type="checkbox"/>	COP-ZD	1SNK900636R0000	10	3.57	
8 Terminal block markers	White <input type="checkbox"/>	Blank marker	MG-CPM 13 41790	1SNB041790R0512	1960	0.23
		Blank card	MC512	1SNK140000R0000	22	9.00
			MC512PA	1SNK149999R0000	20	10.00
		Universal wire markers holder	Grey <input type="checkbox"/>	UMH	1SNK900611R0000	10

Complete list of accessories is indicated in the terminal block datasheet including end stops.

Some accessories such as jumper bars may modify the terminal block's ratings: Complete information available in the accessories section of the catalog.

Technical data valid for copper conductors only.

CDS4 Screw clamp female plugs

Female plug - 5.2 mm 0.205 in spacing

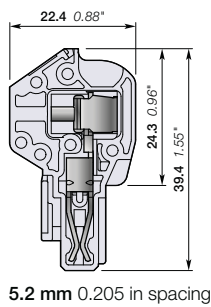
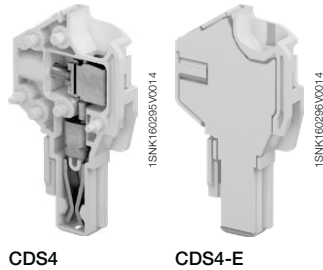

Description

- Create your own female plug assemblies without any special tools, easily snap together multiple plugs for optimal ergonomics and quick assembly,
- Increase your flexibility: eliminate stock of pre-configured female plugs, easily add an extra plug in case of needed modification,
- Reduce your stock of unitary plugs up to 30%: only two plug variants are required to compose your own subsets of plugs from 2 to 15 poles.

Ordering details

Description	Color	Type	Part Number	Pkg qty	Weight (1 pce) g
Female plugs	Grey <input type="checkbox"/>	CDS4	1SNK805714R0000	50	3.90
Female plugs without outer nubs - Closed		CDS4-E	1SNK805715R0000	50	4.10

Main technical data

Connecting capacity		IEC	UL - CSA	Mounting instructions	
1 conductor per clamp	Rigid: Solid/Stranded	0.2 ... 4 mm ²	24 ... 10 AWG	Rail	
	Flexible without ferrule	0.22 ... 4 mm ²			
	Flexible with non insulated ferrule	0.22 ... 4 mm ²	24 ... 10 AWG	Wire stripping length	
	Flexible with insulated ferrule	0.22 ... 2.5 mm ²	24 ... 12 AWG		
	Gauge	A3-B3			
2 conductors per clamp	Rigid: Solid/Stranded	0.2 ... 1.5 mm ²	24 ... 16 AWG	Tool	
	Flexible without ferrule	0.22 ... 1.5 mm ²			
	Flexible with twin ferrule	0.22 ... 1.5 mm ²	24 ... 16 AWG		
Rated current / Rated cross section		29 A / 4 mm ²	28 A / 10 AWG	Torque	
Rated short-time withstand current (1s)		480 A			
Rated voltage		800 V	300 V		
Impulse withstand voltage		8000 V			
Protection		IP20	NEMA 1		

The connecting capacity data for one Rigid: Solid/Stranded, or one Flexible conductor (when applicable) is a mandatory information required by IEC, UL and CSA standards (Copper conductors). All other data are provided as supplementary information only. For more details, please consult our CB, UL or CSA certificates and technical datasheet available on <http://www.TE.com>

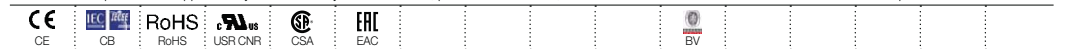

Mounting instructions

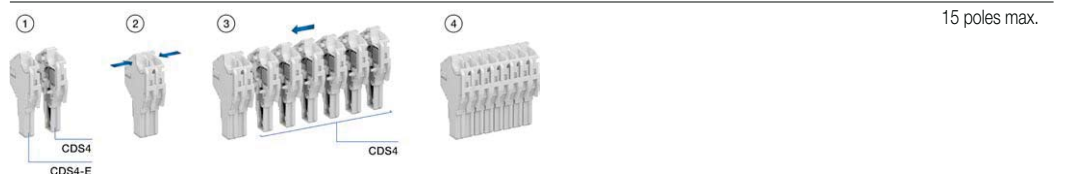

Accessories

Description	Color	Type	Part Number	Pkg qty	Weight (1 pce) g
1 Locking devices	Black <input checked="" type="checkbox"/>	VR-ZD	1SNK900637R0000	50	0.7
2 Cable Clamp	Dark grey <input checked="" type="checkbox"/>	PT-ZD	1SNK900660R0000	50	1.04
3 Terminal block markers	White <input type="checkbox"/>	MG-CPM 13 41790	1SNB041790R0512	1960	0.23
		MG-CPMFA 43196	1SNB043196R0012	350	2.56
		MC512	1SNK140000R0000	22	9.00
		MC512PA	1SNK149999R0000	20	10.00
	Universal wire markers holder	Grey <input type="checkbox"/>	UMH	1SNK900611R0000	10

Complete list of accessories is indicated in the terminal block datasheet including end stops. Some accessories such as jumper bars may modify the terminal block's ratings: Complete information available in the accessories section of the catalog.

Technical data valid for copper conductors only.

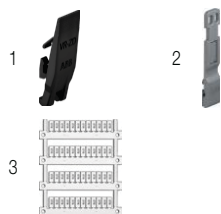

ZDS4-22-R1 Screw clamp pluggable terminal blocks

Feed-through - 6 mm 0.236 in spacing

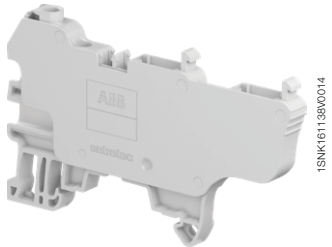

ZDS4-22-R1

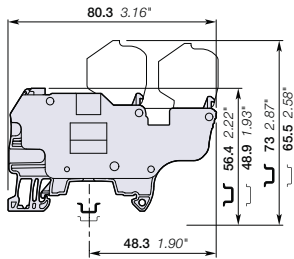

6 mm 0.236 in spacing

Description

- Increase your productivity with pluggable terminal blocks: possibility of pre-produced plugs harnesses, time saving plug and play assembly, reduced transportation panels preparation and final installation, easily connect sub-assemblies together,
- Simplify and secure your installation: in site faulty connection errors are eliminated, prior connection testing is eased and reliable, test connectors (TC5-R1 + ES-TC6) withstanding 10 000 operations are compatible for convenient testing.

Ordering details

Description	Color	Type	Part Number	Pkg qty	Weight (1 pce) g
Feed-through 4 connections	Grey <input type="checkbox"/>	ZDS4-22-R1	1SNK806013R0000	40	12.60

Main technical data

Connecting capacity		IEC	UL - CSA
1 conductor per clamp	Rigid: Solid/Stranded	0.2 ... 4 mm²	24 ... 10 AWG
	Flexible without ferrule	0.22 ... 4 mm²	24 ... 10 AWG
	Flexible with non insulated ferrule	0.22 ... 4 mm²	24 ... 10 AWG
	Flexible with insulated ferrule	0.22 ... 4 mm²	24 ... 10 AWG
	Gauge	A3-B3	
2 conductors per clamp	Rigid: Solid/Stranded	0.2 ... 1.5 mm²	24 ... 16 AWG
	Flexible without ferrule	0.22 ... 1.5 mm²	24 ... 16 AWG
	Flexible with twin ferrule	0.22 ... 1.5 mm²	24 ... 16 AWG
Rated current / Rated cross section		29 A / 4 mm²	28 A / 10 AWG
Rated short-time withstand current (1s)		480 A	
Rated voltage		800 V	300 V
Impulse withstand voltage		8000 V	
Protection		IP20	NEMA 1

Mounting instructions

Rail		TH 35-7.5, TH 35-15
Wire stripping length		10.5 mm 0.413 in
Tool		Flat screwdriver Ø 3.5 mm Ø 0.138 in
Torque		0.6 Nm ± 0.1 5.31 lb.in ± 0.885

The connecting capacity data for one Rigid: Solid/Stranded, or one Flexible conductor (when applicable) is a mandatory information required by IEC, UL and CSA standards (Copper conductors). All other data are provided as supplementary information only. For more details, please consult our CB, UL or CSA certificates and technical datasheet available on <http://www.TE.com>

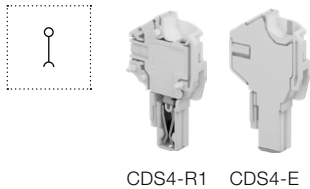
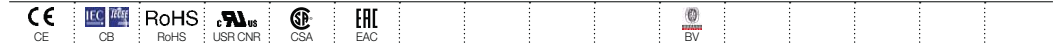

CDS4-R1 CDS4-E

Female plugs

Description	Color	Type	Part Number	Pkg qty	Weight (1 pce) g
Female plugs 1 pole	Grey <input type="checkbox"/>	CDS4-R1	1SNK806714R0000	50	4.10
Female plugs without outer nubs - Closed		CDS4-E	1SNK805715R0000	50	4.10

15 poles max.

Accessories

Description	Color	Type	Part Number	Pkg qty	Weight (1 pce) g
1 End stops 10 mm 0.394 in	Dark grey <input checked="" type="checkbox"/>	BAM4	1SNK900001R0000	50	14.00
2 Jumper bars 2 poles 41 A (IEC) 3 poles 41 A (IEC) 4 poles 41 A (IEC) 5 poles 41 A (IEC) 10 poles 41 A (IEC) 50 poles 41 A (IEC)	Orange <input checked="" type="checkbox"/>	JB6-2	1SNK906302R0000	50	1.30
		JB6-3	1SNK906303R0000	50	2.10
		JB6-4	1SNK906304R0000	50	2.90
		JB6-5	1SNK906305R0000	50	3.60
		JB6-10	1SNK906310R0000	20	7.40
		JB6-50	1SNK906350R0000	10	38.10
3 Circuit separators 3 mm 0.118 in	Dark grey <input checked="" type="checkbox"/>	CS-R3	1SNK900107R0000	20	6.40
4 Test adapters For test plugs DIA 2 mm 0.079 in For test plugs DIA 4 mm 0.157 in	Dark grey <input checked="" type="checkbox"/>	TP2	1SNK900203R0000	20	1.70
		TP4	1SNK900205R0000	20	2.40
5 Test connectors End module, 5.2 mm 0.205 in	Dark grey <input checked="" type="checkbox"/>	TC5-R1	1SNK900201R0000	10	5.20
6 Spacers 0.8 mm 0.031 in	Dark grey <input checked="" type="checkbox"/>	ES-TC6	1SNK900105R0000	10	0.80
7 Coding pegs	Dark grey <input checked="" type="checkbox"/>	COP-ZD	1SNK900636R0000	10	3.57
8 Terminal block markers	White <input type="checkbox"/>	MG-CPM 13 41791	1SNB041791R0612	1680	0.27
		MC612	1SNK150000R0000	22	10.00
		MC612PA	1SNK159999R0000	20	11.00
		UMH	1SNK900611R0000	10	0.20

Complete list of accessories is indicated in the terminal block datasheet including end stops.

Some accessories such as jumper bars may modify the terminal block's ratings: Complete information available in the accessories section of the catalog.

Technical data valid for copper conductors only.

CDS4-R1 Screw clamp female plugs

Female plug - 6 mm 0.236 in spacing

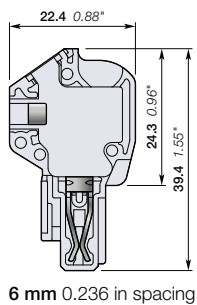
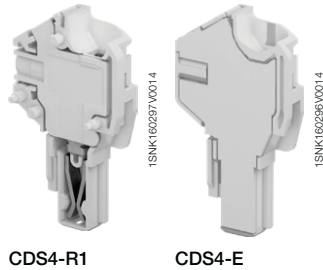

Description

- Create your own female plug assemblies without any special tools, easily snap together multiple plugs for optimal ergonomics and quick assembly,
- Increase your flexibility: eliminate stock of pre-configured female plugs, easily add an extra plug in case of needed modification,
- Reduce your stock of unitary plugs up to 30%: only two plug variants are required to compose your own subsets of plugs from 2 to 15 poles.

Ordering details

Description	Color	Type	Part Number	Pkg qty	Weight (1 pce) g
Female plugs	Grey <input type="checkbox"/>	CDS4-R1	1SNK806714R0000	50	4.10
Female plugs without outer nubs - Closed		CDS4-E	1SNK805715R0000	50	4.10

Main technical data

Connecting capacity		IEC	UL - CSA	Mounting instructions	
1 conductor per clamp	Rigid: Solid/Stranded	0.2 ... 4 mm²	24 ... 10 AWG	Rail	
	Flexible without ferrule	0.22 ... 4 mm²		Wire stripping length	10.5 mm 0.413 in
	Flexible with non insulated ferrule	0.22 ... 4 mm²	24 ... 10 AWG		
	Flexible with insulated ferrule	0.22 ... 4 mm²	24 ... 10 AWG		
Gauge		A3-B3			
2 conductors per clamp	Rigid: Solid/Stranded	0.2 ... 1.5 mm²	24 ... 16 AWG	Tool	Flat screwdriver Ø 3.5 mm Ø 0.138 in
	Flexible without ferrule	0.22 ... 1.5 mm²			
	Flexible with twin ferrule	0.22 ... 1.5 mm²	24 ... 16 AWG		
Rated current / Rated cross section		29 A / 4 mm²	28 A / 10 AWG	Torque	0.6 Nm ± 0.1 5.31 lb.in ± 0.885
Rated short-time withstand current (1s)		480 A			
Rated voltage		800 V	300 V		
Impulse withstand voltage		8000 V			
Protection		IP20	NEMA 1		

The connecting capacity data for one Rigid: Solid/Stranded, or one Flexible conductor (when applicable) is a mandatory information required by IEC, UL and CSA standards (Copper conductors). All other data are provided as supplementary information only. For more details, please consult our CB, UL or CSA certificates and technical datasheet available on <http://www.TE.com>

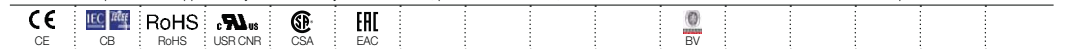

Mounting instructions

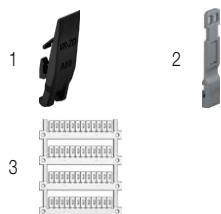

Accessories

Description	Color	Type	Part Number	Pkg qty	Weight (1 pce) g
1 Locking devices	Black <input checked="" type="checkbox"/>	VR-ZD	1SNK900637R0000	50	0.7
2 Cable Clamp	Dark grey <input checked="" type="checkbox"/>	PT-ZD	1SNK900660R0000	50	1.04
3 Terminal block markers	White <input type="checkbox"/>	MG-CPM 13 41791	1SNB041791R0612	1680	0.27
		MG-CPMFA 43196	1SNB043196R0012	350	2.56
		MC612	1SNK150000R0000	22	10.00
		MC612PA	1SNK159999R0000	20	11.00
	Universal wire markers holder	Grey <input type="checkbox"/>	UMH	1SNK900611R0000	10

Complete list of accessories is indicated in the terminal block datasheet including end stops. Some accessories such as jumper bars may modify the terminal block's ratings: Complete information available in the accessories section of the catalog.

Technical data valid for copper conductors only.

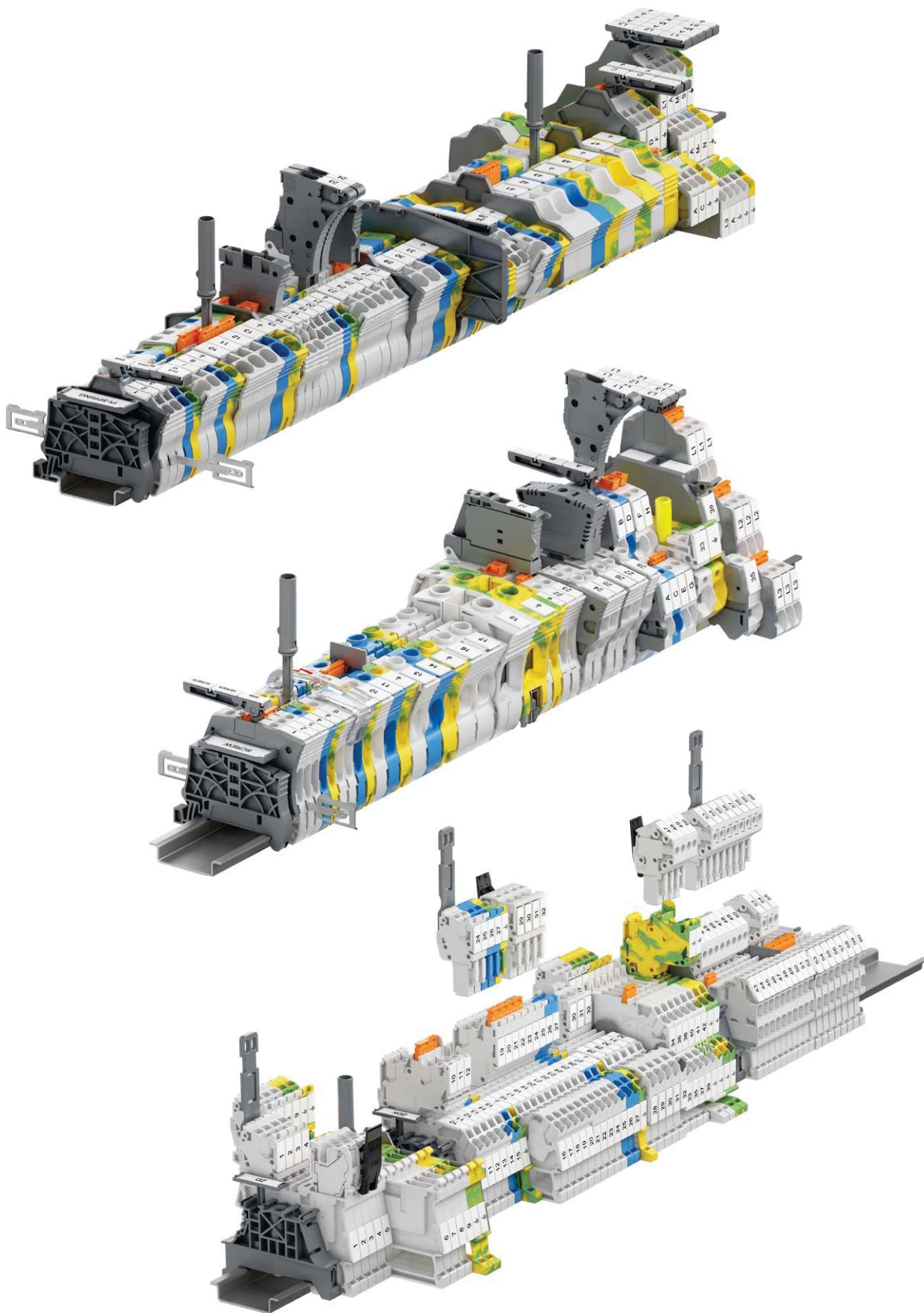

SNK series, terminal block accessories

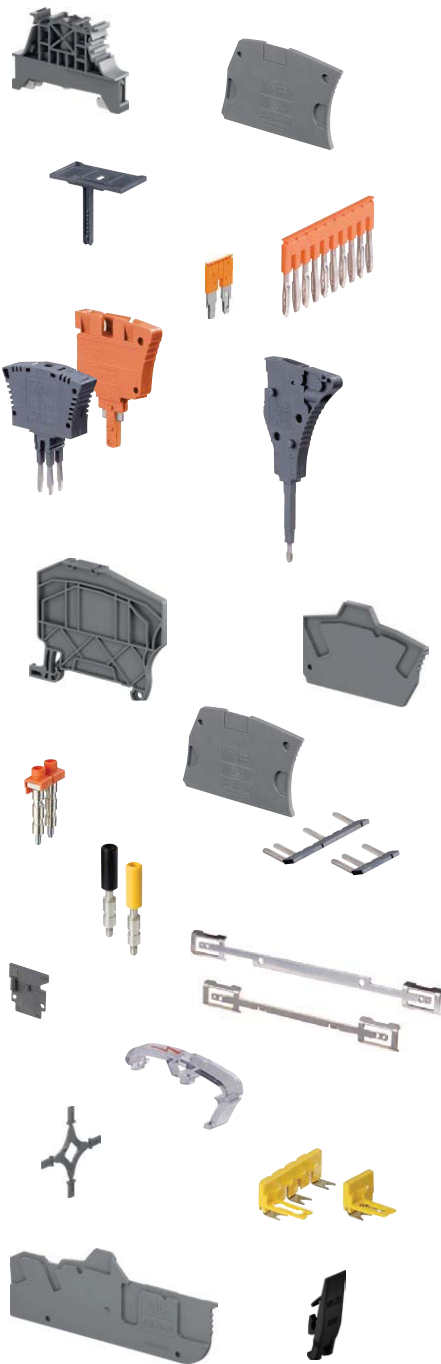

Common terminal block accessories

Mounting rail	PR	196-198
Screw end stops	BAM4, BAZH1	199
Screwless end stops	BAZ1	200
Label holders	LH, LH-R1	201
	LH-J	202
Screwless jumper bars	JB5	203
	JB6	204
	JB8	205
	JB10	206
	JB12	207
Cross spacing jumpers	JB85-3	208
Test adapters	TP2, TP4	209
Test connectors	TC5	210
Component plugs	PG5-R2	211
	PG5, PG5-R1	212
Screwdrivers	TO	213
Crimping tools	PS	213

PI-Spring terminal block accessories

End sections	EK	214-216
Circuit separators	CS-R2, CS-R3	217-218
Shield connectors	SHBP, SHB	219

Screw clamp terminal block accessories

End sections	ES	220-221
Screw jumper bars	JB8	222
	JB16, JB22	223
	JB26	224
	BJMI31, BJMI36	225
Lateral jumper bars	PC8, PC81	226
Circuit separator	CS, CS-R1	227
Shield connectors	SHBS, SHB	228
Protecting covers	PL	229
	CO, KCO	230
Short circuit bridges	SC-JB8	231
Test sockets	AJS9	232

Pluggable terminal block accessories

End sections	EDK, EDS	233-234
Coding pegs	COP	235
Locking devices	VR	235

PR mounting rail

Common terminal block accessories

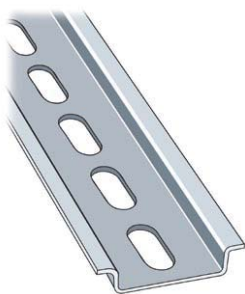

1SNK160017S0201

PR30

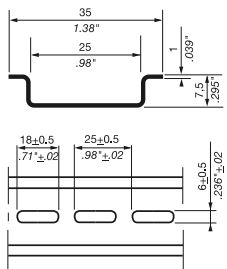

2000 mm 78.74 in spacing

Description

- Pre-punched symmetrical mounting rail,
- The slotted holes ease the mounting and allow to use existing and/or numerous fixings,
- Particularly well designed for fixing onto back-plates and for terminal assemblies of small dimensions.

Ordering details

Description	Color	Type	Part Number	Pkg meter	Weight (1 pce) g
Prepunched rail		PR30	1SNA173220R0500	2	328.00

Please note that for all rails: 1 part number equal 1 meter (39 in). Packing of 2 meters (78 in) minimum. Check that your order quantity is a multiple of 2.

Main technical data

Material	Zinc plating and passivation steel				
Rail	TH 35-7.5				
	IEC	UL - CSA			
Equivalent E-Cu cross section	All the main technical data provided are "manufacturer" values.				
RoHS	RoHS				

Mounting instructions

- In order to guarantee the performances and security of your installation, please ensure the rail and its fixings can withstand the static and dynamic loads of the components mounted on it;
- To prevent the rail from flexing (1 mm 0.039 in rail thickness only), fixing is recommended every 250 mm 9.84 in;
- To prevent any issues during mounting, screw heads used for rail fixing should not protrude from the rail (7,5 mm 0.295 in rail height only).

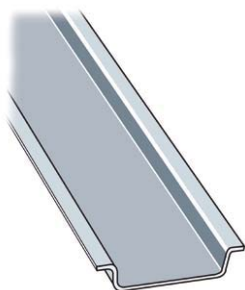

1SNK160017S0201

PR3.Z2

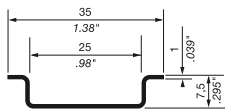

2000 mm 78.74 in spacing

Description

- Symmetrical mounting rail complying with IEC60715,
- Particularly well designed for fixing onto back-plates and for terminal assemblies of small dimensions.

Ordering details

Description	Color	Type	Part Number	Pkg meter	Weight (1 pce) g
		PR3.Z2	1SNA174300R1700	2	718.00

Please note that for all rails: 1 part number equal 1 meter (39 in). Packing of 2 meters (78 in) minimum. Check that your order quantity is a multiple of 2.

Main technical data

Material	Zinc plating and passivation steel				
Rail	TH 35-7.5				
	IEC	UL - CSA			
Equivalent E-Cu cross section	16 mm ²				
	All the main technical data provided are "manufacturer" values.				
RoHS	RoHS				

Mounting instructions

- In order to guarantee the performances and security of your installation, please ensure the rail and its fixings can withstand the static and dynamic loads of the components mounted on it;
- To prevent the rail from flexing (1 mm 0.039 in rail thickness only), fixing is recommended every 250 mm 9.84 in;
- To prevent any issues during mounting, screw heads used for rail fixing should not protrude from the rail (7,5 mm 0.295 in rail height only).

Technical data valid for copper conductors only.

PR mounting rail

Common terminal block accessories

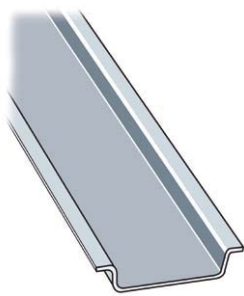

1SNA600073F0000

PR3.G2

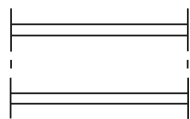
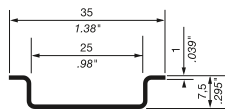

2000 mm 78.74 in spacing

Description

- Symmetrical mounting rail made of galvanised steel, complying with IEC60715,
- Particularly well designed for fixing onto back-plates and for terminal assemblies of small dimensions.

Ordering details

Description	Color	Type	Part Number	Pkg meter	Weight (1 pce) g
		PR3.G2	1SNA164800R0300	2	718.00

Please note that for all rails: 1 part number equal 1 meter (39 in). Packing of 2 meters (78 in) minimum. Check that your order quantity is a multiple of 2.

Main technical data

Material	Galvanised steel		
Rail	TH 35-7.5		
	IEC	UL - CSA	
Equivalent E-Cu cross section	16 mm ²		

All the main technical data provided are "manufacturer" values.

RoHS																			
RoHS																			

Mounting instructions

- In order to guarantee the performances and security of your installation, please ensure the rail and its fixings can withstand the static and dynamic loads of the components mounted on it;
- To prevent the rail from flexing (1 mm 0.039 in rail thickness only), fixing is recommended every 250 mm 9.84 in;
- To prevent any issues during mounting, screw heads used for rail fixing should not protrude from the rail (7,5 mm 0.295 in rail height only).

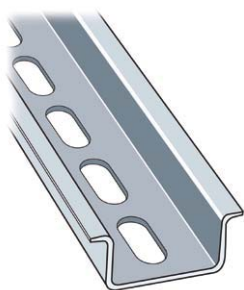

1SNA600074F0000

PR50

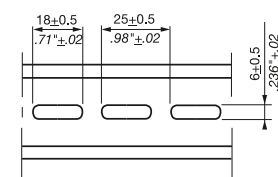
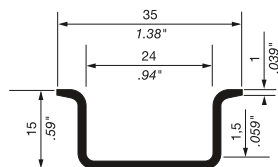

2000 mm 78.74 in spacing

Description

- Pre-punched symmetrical mounting rail,
- The slotted holes ease the mounting and allow to use existing and/or numerous fixings.

Ordering details

Description	Color	Type	Part Number	Pkg meter	Weight (1 pce) g
Prepunched rail		PR50	1SNA178529R0400	2	1288.00

Please note that for all rails: 1 part number equal 1 meter (39 in). Packing of 2 meters (78 in) minimum. Check that your order quantity is a multiple of 2.

Main technical data

Material	Zinc plating and passivation steel		
Rail	TH 35-15		
	IEC	UL - CSA	
Equivalent E-Cu cross section			

All the main technical data provided are "manufacturer" values.

RoHS																			
RoHS																			

Mounting instructions

- In order to guarantee the performances and security of your installation, please ensure the rail and its fixings can withstand the static and dynamic loads of the components mounted on it;
- To prevent the rail from flexing, fixing is recommended every 700 mm 27.6 in;
- In order to increase the accessibility of your terminal assembly, we recommend the use of our rail offset brackets EM45 (order code 1SNA008521R2600) for a 45° orientation of the rail.

Technical data valid for copper conductors only.

PR mounting rail

Common terminal block accessories

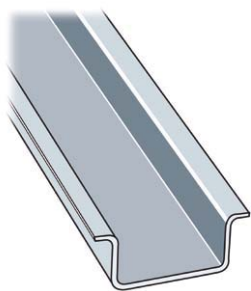

1SNA00075F0000

PR5

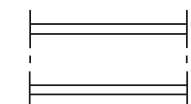
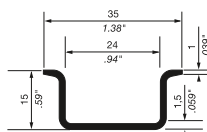

2000 mm 78.74 in spacing

Description

- Symmetrical mounting rail.

Ordering details

Description	Color	Type	Part Number	Pkg meter	Weight (1 pce) g
		PR5	1SNA168700R2200	2	1200.00

Please note that for all rails: 1 part number equal 1 meter (39 in). Packing of 2 meters (78 in) minimum. Check that your order quantity is a multiple of 2.

Main technical data

Material	Zinc plating and passivation steel
Rail	TH 35-15

	IEC	UL - CSA
--	-----	----------

Equivalent E-Cu cross section

All the main technical data provided are "manufacturer" values.

RoHS									
RoHS									

Mounting instructions

- In order to guarantee the performances and security of your installation, please ensure the rail and its fixings can withstand the static and dynamic loads of the components mounted on it;
- To prevent the rail from flexing, fixing is recommended every 700 mm 27.6 in;
- In order to increase the accessibility of your terminal assembly, we recommend the use of our rail offset brackets EM45 (order code 1SNA008521R2600) for a 45° orientation of the rail.

5

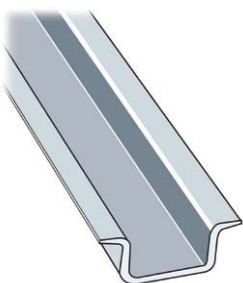

1SNA00076F0000

PR4

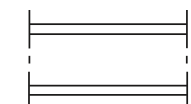
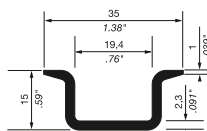

2000 mm 78.74 in spacing

Description

- Symmetrical mounting rail complying with IEC60715,
- The rigidity of the rail is maximised by the 2.3 mm 0.090 in thickness of the rail, and by its solid, non slotted construction,
- PR4 TH 35-15 is the most rigid mounting rail solution and it can support

Ordering details

Description	Color	Type	Part Number	Pkg meter	Weight (1 pce) g
Recommended for SNK ground terminal blocks up to 35 mm ² 2 AWG		PR4	1SNA168500R1200	2	915.00

Please note that for all rails: 1 part number equal 1 meter (39 in). Packing of 2 meters (78 in) minimum. Check that your order quantity is a multiple of 2.

Main technical data

Material	Zinc plating and passivation steel
Rail	TH 35-15

	IEC	UL - CSA
--	-----	----------

Equivalent E-Cu cross section

All the main technical data provided are "manufacturer" values.

RoHS									
RoHS									

Mounting instructions

- In order to guarantee the performances and security of your installation, please ensure the rail and its fixings can withstand the static and dynamic loads of the components mounted on it;
- To prevent the rail from flexing, fixing is recommended every 700 mm 27.6 in;
- In order to increase the accessibility of your terminal assembly, we recommend the use of our rail offset brackets EM45 (order code 1SNA008521R2600) for a 45° orientation of the rail.

Technical data valid for copper conductors only.

1SNA160041S0201



Screw end stops

Common terminal block accessories



1SNK160333V0014

BAM4

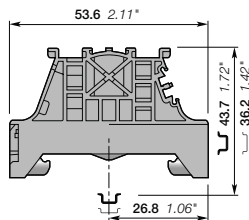

10 mm 0.394 in spacing

Mounting instructions



BAM4 screw end stops

Description

- Give efficient support to the SNK terminal blocks assemblies thanks to the BAM4 double gripping rail contact,
- Ease the assemblies identification with the BAM4 marking location compatible with all SNK markers and labels.

Ordering details

Description	Color	Type	Part Number	Pkg qty	Weight (1 pce) g
10 mm 0.394 in spacing	Dark grey	BAM4	1SNK900001R0000	50	14.00

Main technical data

Material specifications	Insulating material Flammability NF F 16 101	Polyamide V0 I2F2	Rail		TH 35-7.5, TH 35-15
Ambient temperature min/max	Service IEC 60068-2-1 Storage Installing	-55 ... +110 °C -67 ... +230 °F -55 ... +110 °C -67 ... +230 °F -5 ... +40 °C +23 ... +104 °F	Tool		Flat screwdriver Ø 5.5 mm Ø 0.217 in
			Torque		0.9 Nm ± 0.1 7.08 lb.in ± 0.88

Mounting instructions

All the main technical data provided are "manufacturer" values

RoHS	RoHS				
------	------	--	--	--	--

Accessories

Description	Color	Type	Part Number	Pkg qty	Weight (1 pce) g
Terminal block markers compatible with MG3	White	MG-CPM 13 41791	1SNB041791R0612	1680	0.27
Blank card In polycarbonate		MC812	1SNK160000R0000	22	10.00
		MC812PA	1SNK169999R0000	20	14.00
Label holder 10 mm 0.394 in width	Dark grey	LH	1SNK900605R0000	50	0.60
		LH-R1	1SNK900607R0000	50	1.10
Universal wire markers holder 5.2 mm 0.205 in spacing	Grey	UMH	1SNK900611R0000	10	0.20

BAZH1 screw end stops

Description

- Give efficient support to the SNK double deck or power terminal blocks assemblies thanks to the BAZH1 double gripping rail contact,
- Ease the assemblies identification with label holders.

Ordering details

Description	Color	Type	Part Number	Pkg qty	Weight (1 pce) g
10 mm 0.394 in spacing	Dark grey	BAZH1	1SNK900102R0000	20	24.00

Main technical data

Material specifications	Insulating material Flammability NF F 16 101	Polyamide V0 I2F2	Rail		TH 35-7.5
Ambient temperature min/max	Service IEC 60068-2-1 Storage Installing	-55 ... +110 °C -67 ... +230 °F -55 ... +110 °C -67 ... +230 °F -5 ... +40 °C +23 ... +104 °F	Tool		Flat screwdriver Ø 5.5 mm Ø 0.217 in
			Torque		1.3 Nm ± 0.1 11.4 lb.in ± 0.88

Mounting instructions

All the main technical data provided are "manufacturer" values

RoHS	RoHS				
------	------	--	--	--	--

Accessories

Description	Color	Type	Part Number	Pkg qty	Weight (1 pce) g
Terminal block markers compatible with MG3	White	MG-CPM 13 41791	1SNB041791R0612	1680	0.27
Blank card In polycarbonate		MC812	1SNK160000R0000	22	10.00
		MC812PA	1SNK169999R0000	20	14.00
Label holder 10 mm 0.394 in width	Dark grey	LH	1SNK900605R0000	50	0.60
		LH-R1	1SNK900607R0000	50	1.10
Universal wire markers holder 5.2 mm 0.205 in spacing	Grey	UMH	1SNK900611R0000	10	0.20

Technical data valid for copper conductors only.



1SNK160094R0014

BAZH1

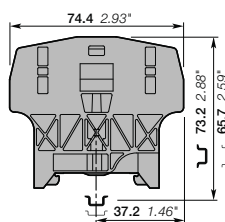

10 mm 0.394 in spacing

Screwless end stops

Common terminal block accessories



BAZ1

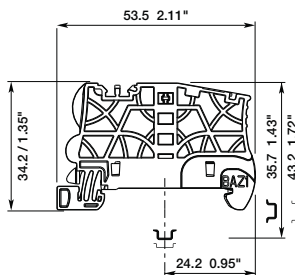

5.2 mm 0.205 in spacing

BAZ1 screwless end stops

Description

- Reduce the size of your terminal block assemblies with the screwless reduced spacing BAZ1 end stop,
- Ease the assemblies identification with various markers and label holders.

Ordering details

Description	Color	Type	Part Number	Pkg qty	Weight (1 pce) g
5.2 mm 0.205 in spacing	Dark grey <input checked="" type="checkbox"/>	BAZ1	1SNK900002R0000	50	5.30

Main technical data

Material specifications	Insulating material	Polyamide
	Flammability	V0
	NF F 16 101	I2F2
Ambient temperature min/max	Service IEC 60068-2-1	-55 ... +110 °C -67 ... +230 °F
	Storage	-55 ... +110 °C -67 ... +230 °F
	Installing	-5 ... +40 °C +23 ... +104 °F

Mounting instructions

Rail	TH 35-7.5

All the main technical data provided are "manufacturer" values

RoHS	RoHS
<input checked="" type="checkbox"/>	<input checked="" type="checkbox"/>

Accessories

Description	Color	Type	Part Number	Pkg qty	Weight (1 pce) g
Terminal block markers compatible with MG3	White <input type="checkbox"/>	MG-CPM 13 41790	1SNB041790R0512	1960	0.23
Blank card compatible with HTP500		MC512	1SNK140000R0000	22	9.00
		MC512PA	1SNK149999R0000	20	10.00
Label holder compatible with AMS600	Dark grey <input checked="" type="checkbox"/>	LH	1SNK900605R0000	50	0.60
		LH-R1	1SNK900607R0000	50	1.10
Universal wire markers holder 5.2 mm 0.205 in spacing	Grey <input type="checkbox"/>	UMH	1SNK900611R0000	10	0.20

Technical data valid for copper conductors only.

Label holder

Common terminal block accessories



1SNK1603340014

LH
10 mm 0.394 in spacing

LH label holder

Description

- Easily identify your terminal blocks assembly with white or yellow labels,
- Adjustable in height for best visibility,
- Compatible with all SNK end stops.

Ordering details

Description	Color	Type	Part Number	Pkg qty	Weight (1 pce) g
10 mm 0.394 in width	Dark grey <input checked="" type="checkbox"/>	LH	1SNK900605R0000	50	0.60

Main technical data

Material specifications	Insulating material Flammability NF F 16 101	Polyamide V0 I2F2			
Ambient temperature min/max	Service IEC 60068-2-1	-55 ... +110 °C	-67 ... +230 °F		
	Storage	-55 ... +110 °C	-67 ... +230 °F		
	Installing	-5 ... +40 °C	+23 ... +104 °F		

All the main technical data provided are "manufacturer" values

RoHS
RoHS

Accessories

Description	Color	Type	Part Number	Pkg qty	Weight (1 pce) g
Self-adhesive precut blank label compatible with HTP500	White <input type="checkbox"/>	MCLH	1SNK900630R0000	25	10.00
Self-adhesive precut blank label compatible with HTP500	White <input type="checkbox"/>	RCPEAD-TT	1SNA235158R0100	25	9.80
	Yellow <input type="checkbox"/>	RCPEAD-TT-YL	1SNA235159R0200	25	12.10
Pre-printed cover marker	Transparent <input checked="" type="checkbox"/>	EPR2	1SNA399726R0700	10	4.00
Precut blank label compatible with MG3	White <input type="checkbox"/>	MG-TAR 45490	1SNB045490R8530	1650	0.371
Self-adhesive precut blank label compatible with MG3	Yellow <input type="checkbox"/>	MG-TAA 49448	1SNB049448R8530	825	0.55
	White <input type="checkbox"/>	MG-TAA 49498	1SNB049498R8530	825	0.55
Self-adhesive precut blank label compatible with HTP500	Yellow <input type="checkbox"/>	MCLH-YL	1SNK900633R0000	25	10.00



1SNK1603350014

LH
19.5 mm 0.768 in spacing

LH-R1 label holder

Description

- Easily identify your terminal blocks assembly with white or yellow labels,
- Adjustable in height for best visibility,
- Compatible with all SNK end stops.

Ordering details

Description	Color	Type	Part Number	Pkg qty	Weight (1 pce) g
19.5 mm 0.768 in width	Dark grey <input checked="" type="checkbox"/>	LH-R1	1SNK900607R0000	50	1.10

Main technical data

Material specifications	Insulating material Flammability NF F 16 101	Polyamide V0 I2F2			
Ambient temperature min/max	Service IEC 60068-2-1	-55 ... +110 °C	-67 ... +230 °F		
	Storage	-55 ... +110 °C	-67 ... +230 °F		
	Installing	-5 ... +40 °C	+23 ... +104 °F		

All the main technical data provided are "manufacturer" values

RoHS
RoHS

Accessories

Description	Color	Type	Part Number	Pkg qty	Weight (1 pce) g
Self-adhesive precut blank label compatible with HTP500	White <input type="checkbox"/>	MCLH-R1	1SNK900631R0000	25	10.00
Precut blank label compatible with AMS600	White <input type="checkbox"/>	RCPEB	1SNA178430R0500	1	
	Transparent <input checked="" type="checkbox"/>	EPR1	1SNA178431R2200	1	0.05
Self-adhesive precut blank label compatible with HTP500	White <input type="checkbox"/>	PIB2-TT	1SNA235155R2600	25	9.70
	Yellow <input type="checkbox"/>	PIB2-TT-YL	1SNA235157R2000	25	9.40
Precut blank label compatible with MG3	White <input type="checkbox"/>	MG-TAR 45194	1SNB045194R1735	900	0.62
Self-adhesive precut blank label compatible with MG3	Yellow <input type="checkbox"/>	MG-TAA 49148	1SNB049148R1735	450	0.91
	White <input type="checkbox"/>	MG-TAA 49198	1SNB049198R1735	450	0.91
Self-adhesive precut blank label compatible with HTP500	Yellow <input type="checkbox"/>	MCLH-R1-YL	1SNK900634R0000	25	10.00

Technical data valid for copper conductors only.

Mounting instructions



Label holder

Common terminal block accessories



1SNK1603470014

LH

4.8 mm 0.189 in spacing

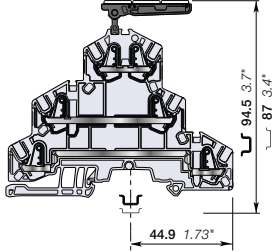

LH-J label holder

Description

Easily identify your block with three standard 5.2 mm 0.205 in spacing SNK markers. It fits in the jumper channel of the SNK terminal blocks.

Ordering details

Description	Color	Type	Part Number	Pkg qty	Weight (1 pce) g
Rotating label holder with three SNK markers housings - 4.8 mm 0.189 in spacing	Dark grey <input checked="" type="checkbox"/>	LH-J	1SNK900606R0000	100	0.73

Main technical data

Material specifications	Insulating material	Polyamide			
	Flammability	V0			
Ambient temperature min/max	NF F 16 101	I2F2			
	Service IEC 60068-2-1	-55 ... +110 °C	-67 ... +230 °F		
	Storage	-55 ... +110 °C	-67 ... +230 °F		
	Installing	-5 ... +40 °C	+23 ... +104 °F		

All the main technical data provided are "manufacturer" values

RoHS	<input checked="" type="checkbox"/>								
RoHS									

Accessories

Description	Color	Type	Part Number	Pkg qty	Weight (1 pce) g
Blank marker compatible with MG3	White <input type="checkbox"/>	MG-CPM 13 41790	1SNB041790R0512	1960	0.23
Blank card compatible with HTP500	White <input type="checkbox"/>	MC512	1SNK140000R0000	22	9.00
	White <input type="checkbox"/>	MC512PA	1SNK149999R0000	20	10.00
Universal wire markers holder 5.2 mm 0.205 in spacing	Grey <input type="checkbox"/>	UMH	1SNK900611R0000	10	0.20

Technical data valid for copper conductors only.

JB5 screwless jumper bars

Common terminal block accessories



1SNK160143F0014

JB5
5.2 mm 0.205 in spacing

Description

Facilitate & secure your jumper bar assembly process:

- Screwless mounting,
- Pre-cut poles for alternated jumpering between terminal blocks,
- Insulated,
- Positive locking,
- Perfectly adapted to low level electrical contact (20mA, 50mV).

Ordering details

Description	Color	Type	Part Number	Pkg qty	Weight (1 pce) g
5.2 mm 0.205 in spacing	Orange	JB5-2	1SNK905302R0000	50	1.30
		JB5-3	1SNK905303R0000	50	2.00
		JB5-4	1SNK905304R0000	50	2.70
		JB5-5	1SNK905305R0000	50	3.50
		JB5-10	1SNK905310R0000	30	7.10
		JB5-50	1SNK905350R0000	10	36.00

Main technical data

Material specifications	Insulating material	Polyamide		
	Flammability	V0		
Ambient temperature min/max	NF F 16 101	I2F3		
	Service IEC 60068-2-1	-55 ... +110 °C	-67 ... +230 °F	
	Storage	-55 ... +110 °C	-67 ... +230 °F	
	Installing	-5 ... +40 °C	+23 ... +104 °F	
		IEC	UL - CSA	Ex e
Rated current		32 A	30 A	
Rated voltage	1 - Standard use	1000 V	600 V	Please consult us
	2 - Cut extremities	800 V	300 V	
	3 - Cut poles	630 V	300 V	
	4 - Alternated poles	400 V	150 V	
	5 - Alternated poles with cut extremities	400 V	150 V	
Impulse withstand voltage		8000 V		
Protection		IP20	NEMA 1	
All the main technical data are indicative "manufacturer" values.				
	RoHS			
	RoHS			

Mounting instructions

①

②

③

④

⑤

1 - Standard use

2 - Cut extremities
For voltage rating > 50 V and Uimp > 2.5 KV, the below accessories must be installed on the cut side of the jumper to guarantee IP20 and voltage rating:

ZS...	Feed-through	CS circuit separator
ZK...	Double deck / triple deck	ES... end section
	All functions	EK... end section

Ensure a good straight cut by positioning the cutting tool on the vertical snicks of the insulated part of the jumper.

15 poles max. recommended for convenient mounting.

3 - Cut poles

4 - Alternated poles

5 - Alternated poles with cut extremities
When using cut jumpers, cut extremities should be placed oppositely to allow end sections / circuit separators placement at each cut extremities.

For all other applications, please consult us.

Technical data valid for copper conductors only.

JB6 screwless jumper bars

Common terminal block accessories



1SNK160143P0014

JB6
6 mm 0.236 in spacing

Description

Facilitate & secure your jumper bar assembly process:

- Screwless mounting,
- Pre-cut poles for alternated jumpering between terminal blocks,
- Insulated,
- Positive locking,
- Perfectly adapted to low level electrical contact (20mA, 50mV).

Ordering details

Description	Color	Type	Part Number	Pkg qty	Weight (1 pce) g
6 mm 0.236 in spacing	Orange	JB6-2	1SNK906302R0000	50	1.30
		JB6-3	1SNK906303R0000	50	2.10
		JB6-4	1SNK906304R0000	50	2.90
		JB6-5	1SNK906305R0000	50	3.60
		JB6-10	1SNK906310R0000	20	7.40
		JB6-50	1SNK906350R0000	10	38.10

Main technical data

Material specifications	Insulating material	Polyamide		
	Flammability	V0		
	NF F 16 101	I2F3		
Ambient temperature min/max	Service IEC 60068-2-1	-55 ... +110 °C	-67 ... +230 °F	
	Storage	-55 ... +110 °C	-67 ... +230 °F	
	Installing	-5 ... +40 °C	+23 ... +104 °F	
		IEC	UL - CSA	Ex e
Rated current		41 A	30 A	
Rated voltage	1 - Standard use	1000 V	600 V	Please consult our dedicated certificates
	2 - Cut extremities	800 V	300 V	
	3 - Cut poles	630 V	300 V	
	4 - Alternated poles	400 V	150 V	
	5 - Alternated poles with cut extremities	400 V	150 V	
Impulse withstand voltage		8000 V		
Protection		IP20	NEMA 1	
All the main technical data are indicative "manufacturer" values.				
	RoHS			
	RoHS			

Mounting instructions

1 - Standard use

2 - Cut extremities
For voltage rating > 50 V and Uimp > 2.5 KV, the below accessories must be installed on the cut side of the jumper to guarantee IP20 and voltage rating:

ZS...	Feed-through	CS circuit separator
ZK...	Double deck / triple deck	ES... end section
	All functions	EK... end section

Ensure a good straight cut by positioning the cutting tool on the vertical snicks of the insulated part of the jumper.

15 poles max. recommended for convenient mounting.

3 - Cut poles

4 - Alternated poles

5 - Alternated poles with cut extremities
When using cut jumpers, cut extremities should be placed oppositely to allow end sections / circuit separators placement at each cut extremities.

For all other applications, please consult us.

Technical data valid for copper conductors only.

1SNK16029S0201

JB8 screwless jumper bars

Common terminal block accessories



1SNK160146P0014

JB8
8 mm 0.315 in spacing

Description

Facilitate & secure your jumper bar assembly process:

- Screwless mounting,
- Pre-cut poles for alternated jumpering between terminal blocks,
- Insulated,
- Positive locking,
- Perfectly adapted to low level electrical contact (20mA, 50mV).

Ordering details

Description		Color	Type	Part Number	Pkg qty	Weight (1 pce) g
8 mm 0.315 in spacing	2 poles	Orange	JB8-2	1SNK908302R0000	50	2.70
	3 poles		JB8-3	1SNK908303R0000	50	4.10
	4 poles		JB8-4	1SNK908304R0000	50	5.60
	5 poles		JB8-5	1SNK908305R0000	40	7.00
	10 poles		JB8-10	1SNK908310R0000	20	14.20

Main technical data

Material specifications	Insulating material	Polyamide		
	Flammability	V0		
	NF F 16 101	I2F3		
Ambient temperature min/max	Service IEC 60068-2-1	-55 ... +110 °C	-67 ... +230 °F	
	Storage	-55 ... +110 °C	-67 ... +230 °F	
	Installing	-5 ... +40 °C	+23 ... +104 °F	
Rated current		IEC	UL - CSA	Ex e
		57 A	42 A	
Rated voltage	1 - Standard use	1000 V	600 V	693 V
	2 - Cut extremities	800 V	300 V	440 V
	3 - Cut poles	630 V	300 V	440 V
	4 - Alternated poles	630 V	150 V	352 V
	5 - Alternated poles with cut extremities	630 V	150 V	352 V
Impulse withstand voltage		6000 V		
Protection		IP20	NEMA 1	
All the main technical data are indicative "manufacturer" values.				
	RoHS			
	RoHS			

Mounting instructions

①

②

③

④

⑤

1 - Standard use

2 - Cut extremities
For voltage rating > 50 V and Uimp > 2.5 KV, the below accessories must be installed on the cut side of the jumper to guarantee IP20 and voltage rating:

ZS...	Feed-through	CS circuit separator
	Double deck / triple deck	ES... end section
ZK...	All functions	EK... end section

Ensure a good straight cut by positioning the cutting tool on the vertical snicks of the insulated part of the jumper.

3 - Cut poles

4 - Alternated poles

5 - Alternated poles with cut extremities
When using cut jumpers, cut extremities should be placed oppositely to allow end sections / circuit separators placement at each cut extremities.

For all other applications, please consult us.

Technical data valid for copper conductors only.

JB10 screwless jumper bars

Common terminal block accessories



1SNK16014BFT014

JB10
10 mm 0.394 in spacing

Description

Facilitate & secure your jumper bar assembly process:

- Screwless mounting,
- Pre-cut poles for alternated jumpering between terminal blocks,
- Insulated,
- Positive locking,
- Perfectly adapted to low level electrical contact (20mA, 50mV).

Ordering details

Description		Color	Type	Part Number	Pkg qty	Weight (1 pce) g
10 mm 0.394 in spacing	2 poles	Orange	JB10-2	1SNK910302R0000	50	4.60
	3 poles		JB10-3	1SNK910303R0000	50	7.10
	4 poles		JB10-4	1SNK910304R0000	40	9.40
	5 poles		JB10-5	1SNK910305R0000	30	12.00
	10 poles		JB10-10	1SNK910310R0000	20	24.00

Main technical data

Material specifications	Insulating material	Polyamide		
	Flammability	V0		
	NF F 16 101	I2F3		
Ambient temperature min/max	Service IEC 60068-2-1	-55 ... +110 °C	-67 ... +230 °F	
	Storage	-55 ... +110 °C	-67 ... +230 °F	
	Installing	-5 ... +40 °C	+23 ... +104 °F	
Rated current		IEC	UL - CSA	Ex e
		76 A	67 A	
Rated voltage	1 - Standard use	1000 V	600 V	693 V
	2 - Cut extremities	800 V	300 V	440 V
	3 - Cut poles	630 V	300 V	440 V
	4 - Alternated poles	400 V	150 V	275 V
	5 - Alternated poles with cut extremities	250 V	150 V	176 V
Impulse withstand voltage		6000 V		
Protection		IP20	NEMA 1	
All the main technical data are indicative "manufacturer" values.				
	RoHS			
	RoHS			

Mounting instructions

1 - Standard use

2 - Cut extremities
For voltage rating > 50 V and Uimp > 2.5 KV, the below accessories must be installed on the cut side of the jumper to guarantee IP20 and voltage rating:

ZS...	Feed-through	CS circuit separator
	Double deck / triple deck	ES... end section
ZK...	All functions	EK... end section

Ensure a good straight cut by positioning the cutting tool on the vertical snicks of the insulated part of the jumper.

3 - Cut poles

4 - Alternated poles

5 - Alternated poles with cut extremities
When using cut jumpers, cut extremities should be placed oppositely to allow end sections / circuit separators placement at each cut extremities.

For all other applications, please consult us.

Technical data valid for copper conductors only.

JB12 screwless jumper bars

Common terminal block accessories



JB12
12 mm 0.472 in spacing

Description

Facilitate & secure your jumper bar assembly process:

- Screwless mounting,
- Pre-cut poles for alternated jumpering between terminal blocks,
- Insulated,
- Positive locking,
- Perfectly adapted to low level electrical contact (20mA, 50mV).

Ordering details

Description	Color	Type	Part Number	Pkg qty	Weight (1 pce) g
12 mm 0.472 in spacing	Orange	JB12-2	1SNK912302R0000	50	4.90
		JB12-3	1SNK912303R0000	50	7.60
		JB12-5	1SNK912305R0000	20	12.90

Main technical data

Material specifications	Insulating material	Polyamide		
	Flammability	V0		
	NF F 16 101	I2F2		
Ambient temperature min/max	Service IEC 60068-2-1	-55 ... +110 °C	-67 ... +230 °F	
	Storage	-55 ... +110 °C	-67 ... +230 °F	
	Installing	-5 ... +40 °C	+23 ... +104 °F	
		IEC	UL - CSA	Ex e
Rated current		76 A	67 A	
Rated voltage	1 - Standard use	1000 V	600 V	693 V
	2 - Cut extremities	800 V	300 V	440 V
	3 - Cut poles	630 V	300 V	440 V
	4 - Alternated poles	320 V	150 V	220 V
	5 - Alternated poles with cut extremities	250 V	150 V	176 V
Impulse withstand voltage		6000 V		
Protection		IP20	NEMA 1	
All the main technical data are indicative "manufacturer" values.				
	RoHS			
	RoHS			

Mounting instructions

①

1 - Standard use

②

2 - Cut extremities

For voltage rating > 50 V and Uimp > 2.5 KV, the below accessories must be installed on the cut side of the jumper to guarantee IP20 and voltage rating:

ZS...	Feed-through	CS circuit separator
	Double deck / triple deck	ES... end section
ZK...	All functions	EK... end section

③

3 - Cut poles

④

4 - Alternated poles

⑤

5 - Alternated poles with cut extremities

When using cut jumpers, cut extremities should be placed oppositely to allow end sections / circuit separators placement at each cut extremities.

For all other applications, please consult us.

Technical data valid for copper conductors only.

JB85-3 cross spacing jumpers

Common terminal block accessories

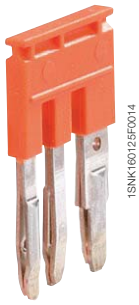

JB85
8 mm 0.315 in spacing

Description

- Allows power distribution between terminal blocks with different spacing,
- JB5-3, JB6-3 and JB8-3 can be used as cross spacing jumpers (see selection table on mounting instructions below).

Ordering details

Description	Color	Type	Part Number	Pkg qty	Weight (1 pce) g
Cross spacing jumpers : 3 poles	Orange	JB85-3	1SNK900603R0000	10	2.80

Main technical data

Material specifications	Insulating material	Polyamide	
	Flammability	V0	
Ambient temperature min/max	NF F 16 101	I2F3	
	Service IEC 60068-2-1	-55 ... +110 °C	-67 ... +230 °F
	Storage	-55 ... +110 °C	-67 ... +230 °F
	Installing	-5 ... +40 °C	+23 ... +104 °F

	IEC	UL - CSA	Ex e
Rated current	32 A	30 A	
Rated voltage	Standard use	1000 V	600 V
	Cut extremities	800 V	300 V
	Cut poles	630 V	300 V
Impulse withstand voltage	8000 V		
Protection	IP20	NEMA 1	

All the main technical data provided are "manufacturer" values

RoHS									
------	--	--	--	--	--	--	--	--	--

Mounting instructions

Cross spacing jumper selection between A and B terminal blocks with different spacing.

	B 5.2 mm	6 mm	8 mm
A 6 mm	JB5.3	-	-
A 8 mm	JB85.3	JB85.3	-
A 10 mm	JB85.3	JB85.3	JB8.3
A 12 mm	JB85.3	JB6.3	-

Yellow cell: for ZS and ZK terminal blocks

Blue cell: for ZS terminal blocks only

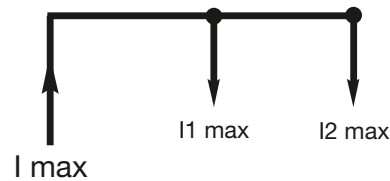

$$I1 \text{ max} + I2 \text{ max} \leq I \text{ max}$$

$$I1 \text{ max} \leq I \text{ rated terminal block}$$

$$I2 \text{ max} \leq I \text{ rated terminal block}$$

Technical data valid for copper conductors only.

Test adapters

Common terminal block accessories



TP
7.6 mm 0.299 in spacing

Mounting instructions

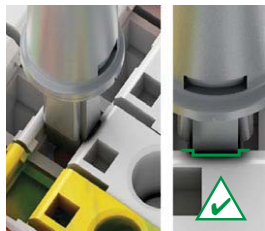

TP2 test adapters

Description

- Insulated test adapter that enables individual voltage control,
- Direct plug-in solution into the jumpers channels,
- Compatible with standard isolated or non isolated test plugs DIA 2 mm 0.079 in and 2.3 mm 0.090 in,
- Withstand more than 10000 operations according to TE Connectivity test standards.

Ordering details

Description	Color	Type	Part Number	Pkg qty	Weight (1 pce)
For test plugs DIA 2 mm 0.079 in	Dark grey ■	TP2	1SNK900203R0000	20	1.70

Main technical data

Material specifications	Insulating material	Polyamide		
	Flammability	V0		
	NF F 16 101	I2F2		
Ambient temperature min/max	Service IEC 60068-2-1	-55 ... +110 °C	-67 ... +230 °F	
	Storage	-55 ... +110 °C	-67 ... +230 °F	
	Installing	-5 ... +40 °C	+23 ... +104 °F	
		IEC	UL - CSA	Ex e
Rated current		10 A		
Rated voltage	Standard use	1000 V	600 V	Not authorized
Impulse withstand voltage		8000 V		
Protection		IP20	NEMA 1	

All the main technical data provided are "manufacturer" values

RoHS
RoHS



TP
7.6 mm 0.299 in spacing

Mounting instructions

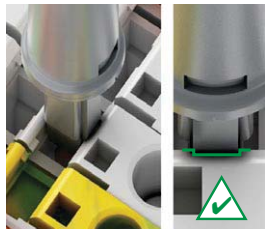

TP4 test adapters

Description

- Isolated test adapter that enables individual voltage control,
- Direct plug-in solution into the jumpers channels,
- Compatible with standard isolated or non isolated test plugs DIA 4 mm 0.157 in,
- Withstand more than 10000 operations according to TE Connectivity test standards.

Ordering details

Description	Color	Type	Part Number	Pkg qty	Weight (1 pce)
For test plugs DIA 4 mm 0.157 in	Dark grey ■	TP4	1SNK900205R0000	20	2.40

Main technical data

Material specifications	Insulating material	Polyamide		
	Flammability	V0		
	NF F 16 101	I2F2		
Ambient temperature min/max	Service IEC 60068-2-1	-55 ... +110 °C	-67 ... +230 °F	
	Storage	-55 ... +110 °C	-67 ... +230 °F	
	Installing	-5 ... +40 °C	+23 ... +104 °F	
		IEC	UL - CSA	Ex e
Rated current		16 A		
Rated voltage	Standard use	1000 V	600 V	Not authorized
Impulse withstand voltage		8000 V		
Protection		IP20	NEMA 1	

All the main technical data provided are "manufacturer" values

RoHS
RoHS

Technical data valid for copper conductors only.

TC5 test connectors

Common terminal block accessories



5.2 mm 0.205 in spacing

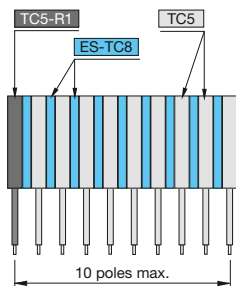
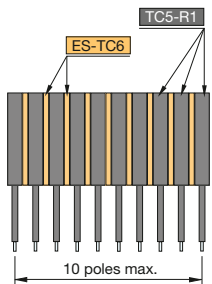
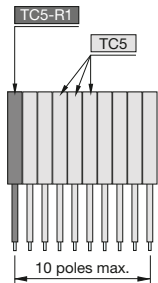



PT-3

Description

Ease the testing of terminal block assemblies:

- Make your own test connector assembly with our modular solution mixing various spacings,
- Direct plug-in solution into the jumpers channels,
- Withstand more than 10000 operations according to TE Connectivity test standards.

Main technical data

Connecting capacity		IEC	UL - CSA	Mounting instructions		
1 conductor per clamp	Rigid: Solid/Stranded	0.2 ... 1.5 mm ²		Rail	Wire stripping length 	8 mm 0.314 in
	Flexible without ferrule	0.22 ... 1.5 mm ²				
	Flexible with non insulated ferrule	0.22 ... 1.5 mm ²		Tool 	Flat screwdriver Ø 2.5 mm Ø 0.098 in	
	Flexible with insulated ferrule	0.22 ... 1.5 mm ²				
Gauge		A1-B1		Torque 	0.5 Nm ± 0.1 3.43 lb.in ± 0.885	
2 conductors per clamp	Rigid: Solid/Stranded	0.2 ... 0.75 mm ²				
		Flexible without ferrule	0.22 ... 0.75 mm ²			
		Flexible with twin ferrule	0.22 ... 0.75 mm ²			
Rated current / Rated cross section		16 A / 1.5 mm ²				
Rated short-time withstand current (1s)		180 A				
Rated voltage		1000 V				
Impulse withstand voltage		8000 V				
Protection		IP20	NEMA 1			

The connecting capacity data for one Rigid: Solid/Stranded, or one Flexible conductor (when applicable) is a mandatory information required by IEC, UL and CSA standards (Copper conductors). All other data are provided as supplementary information only. For more details, please consult our CB, UL or CSA certificates and technical datasheet available on <http://www.TE.com>

Material specifications		Insulating material	Polyamide	
Flammability		NF F 16 101	V0	
Ambient temperature min/max		Service IEC 60068-2-1	-55 ... +110 °C	-67 ... +230 °F
		Storage	-55 ... +110 °C	-67 ... +230 °F
		Installing	-5 ... +40 °C	+23 ... +104 °F

All the main technical data provided are *manufacturer* values

RoHS	
RoHS	

Ordering details

Test connectors for 5.2 mm 0.205 in spacing terminal blocks

Description	Color	Type	Part Number	Pkg qty	Weight (1 pce) g
Test connectors 5.2 mm 0.205 in spacing	Dark grey	TC5	1SNK900200R0000	10	5.20
End module, 5.2 mm 0.205 in		TC5-R1	1SNK900201R0000	10	5.20

Ordering details

Test connectors for 6 mm 0.236 in spacing terminal blocks

Description	Color	Type	Part Number	Pkg qty	Weight (1 pce) g
Test connectors End module, 5.2 mm 0.205 in	Dark grey	TC5-R1	1SNK900201R0000	10	5.20
Spacers 0.8 mm 0.031 in spacing		ES-TC6	1SNK900105R0000	10	0.80

Ordering details

Test connectors for 8 mm 0.315 in spacing terminal blocks

Description	Color	Type	Part Number	Pkg qty	Weight (1 pce) g
Test connectors 5.2 mm 0.205 in spacing	Dark grey	TC5	1SNK900200R0000	10	5.20
End module, 5.2 mm 0.205 in		TC5-R1	1SNK900201R0000	10	5.20
Spacers 2.8 mm 0.110 in spacing		ES-TC8	1SNK900104R0000	10	1.40

Accessories

Description	Color	Type	Part Number	Pkg qty	Weight (1 pce) g
Cable clamps	Dark grey	PT-3	1SNK900625R0000	20	1.00
Terminal block markers	White	MG-CPM 13 41790	1SNB041790R0512	1960	0.23
		MC512	1SNK140000R0000	22	9.00
		MC512PA	1SNK149999R0000	20	10.00
Universal wire markers holder	Grey	UMH	1SNK900611R0000	10	0.20

Technical data valid for copper conductors only.

Component plugs

Common terminal block accessories

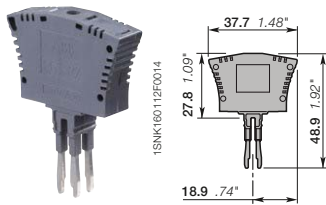

PG5

9.95 mm 0.392 in spacing

Mounting instructions

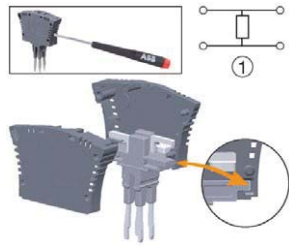

- Open the PG5-R2 with a flat screw-driver DIA . 3.5 mm 0.138 in,
- Use a soldering iron to fix your component,
- Close the PG5-R2,
- Plug-in in the terminal blocks jumper channels.

PG5-R2 component plugs

Description

- Component holder compatible with 5.2 mm 0.205 in spacing ZS4 feed-through terminal blocks,
- Fit components 16 x 16 x 8.5 mm 0.630 x 0.630 x 0.335 in (not supplied with plug) such as resistors, diodes, varistance,
- Direct plug-in into the terminal blocks jumper channels,
- Maximum dissipated power: 2 W.

Ordering details

Description	Color	Type	Part Number	Pkg qty	Weight (1 pce) g
Components insertion between 2 blocks	Dark grey <input checked="" type="checkbox"/>	PG5-R2	1SNK900403R0000	20	8.00

Main technical data

Material specifications	Insulating material	Polyamide			
	Flammability	V0			
	NF F 16 101	I2F2			
Ambient temperature min/max	Service IEC 60068-2-1	-55 ... +110 °C	-67 ... +230 °F		
	Storage	-55 ... +110 °C	-67 ... +230 °F		
	Installing	-5 ... +40 °C	+23 ... +104 °F		
		IEC	UL - CSA		
Rated current					
Rated voltage		250 V			
Impulse withstand voltage		4000 V			
Protection		IP20	NEMA 1		

All the main technical data provided are "manufacturer" values

	RoHS				
	RoHS				

Accessories

Description	Color	Type	Part Number	Pkg qty	Weight (1 pce) g	
Terminal block markers	White <input type="checkbox"/>	MG-CPM 13 41790	1SNB041790R0512	1960	0.23	
Blank card		In polycarbonate	MC512	1SNK140000R0000	22	9.00
		Blank card	MC512PA	1SNK149999R0000	20	10.00
Universal wire markers holder	Grey <input type="checkbox"/>	UMH	1SNK900611R0000	10	0.20	

Technical data valid for copper conductors only.

Component plugs

Common terminal block accessories

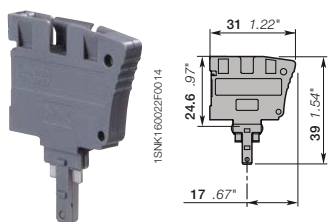

PG5
5.2 mm 0.205 in spacing

Mounting instructions



– Direct plug-in in disconnect with plug terminal block

PG5 component plugs

Description

- Ease the components installation (components not supplied with plug) with our quick plug-in mounting system which avoids soldering process,
- Accept 8.8 x 3.2 mm 0.346 x 0.125 in components such as resistors, diodes or subminiature fuses (fully encapsulated),
- Maximum dissipated power: 1 W.

Ordering details

Description	Color	Type	Part Number	Pkg qty	Weight (1 pce) g
Components in series with circuit	Dark grey <input checked="" type="checkbox"/>	PG5	1SNK900401R0000	20	3.50

Main technical data

Material specifications	Insulating material	Polyamide			
	Flammability	V0			
	NF F 16 101	I2F2			
Ambient temperature min/max	Service IEC 60068-2-1	-55 ... +110 °C	-67 ... +230 °F		
	Storage	-55 ... +110 °C	-67 ... +230 °F		
	Installing	-5 ... +40 °C	+23 ... +104 °F		
		IEC	UL - CSA		
Rated current					
Rated voltage		400 V	150 V		
Impulse withstand voltage		6000 V			
Protection		IP20	NEMA 1		

All the main technical data provided are "manufacturer" values

RoHS

Accessories

Description	Color	Type	Part Number	Pkg qty	Weight (1 pce) g
Terminal block markers	White <input type="checkbox"/>	MG-CPM 13 41790	1SNB041790R0512	1960	0.23
Blank card	In polycarbonate	MC512	1SNK140000R0000	22	9.00
		MC512PA	1SNK149999R0000	20	10.00
Universal wire markers holder	Grey <input type="checkbox"/>	UMH	1SNK900611R0000	10	0.20

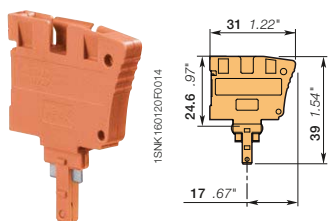

PG5
5.2 mm 0.205 in spacing

Mounting instructions



- PG5-R1 totally inserted: closed circuit,
- PG5-R1 inserted in central position: open circuit, plug secured in isolated central position

PG5-R1 disconnect plugs

Description

Allow disconnect function when associated with the disconnect with plug terminal blocks.

Ordering details

Description	Color	Type	Part Number	Pkg qty	Weight (1 pce) g
Equipped with linking bar	Orange <input checked="" type="checkbox"/>	PG5-R1	1SNK900402R0000	20	3.50

Main technical data

Material specifications	Insulating material	Polyamide			
	Flammability	V0			
	NF F 16 101	I2F3			
Ambient temperature min/max	Service IEC 60068-2-1	-55 ... +110 °C	-67 ... +230 °F		
	Storage	-55 ... +110 °C	-67 ... +230 °F		
	Installing	-5 ... +40 °C	+23 ... +104 °F		
		IEC	UL - CSA		
Rated current		18 A	20 A		
Rated voltage		400 V	150 V		
Impulse withstand voltage		6000 V			
Protection		IP20	NEMA 1		

All the main technical data provided are "manufacturer" values

RoHS

Accessories

Description	Color	Type	Part Number	Pkg qty	Weight (1 pce) g
Terminal block markers	White <input type="checkbox"/>	MG-CPM 13 41790	1SNB041790R0512	1960	0.23
Blank card	In polycarbonate	MC512	1SNK140000R0000	22	9.00
		MC512PA	1SNK149999R0000	20	10.00
Universal wire markers holder	Grey <input type="checkbox"/>	UMH	1SNK900611R0000	10	0.20

Technical data valid for copper conductors only.

Tools

Common terminal block accessories



TO

1SNK160242F0014

TO screwdrivers

Description

Flat head screwdriver

Ordering details

Description	Color	Type	Part Number	Pkg qty	Weight (1 pce) g
Insulated screwdriver 1000V IEC dimensions 3.5 x 100 mm 0.138 x 3.94 in		TO3.5-100-INS	1SNK900644R0000	1	37.00
screwdriver 3.5 x 50 mm 0.138 x 1.97 in		TO3.5-50	1SNK900640R0000	12	22.00
screwdriver 3.5 x 50 mm 0.138 x 1.97 in Angled 60°		TO3.5-50-A	1SNK900659R0000	12	21.6
screwdriver 4 x 100 mm 0.157 x 3.94 in		TO4-100	1SNK900641R0000	1	42.00
screwdriver 5.5 x 125 mm 0.216 x 4.92 in		TO5.5-125	1SNK900642R0000	1	75.50
screwdriver 6.5 x 150 mm 0.256 x 5.90 in		TO6.5-150	1SNK900643R0000	1	121.00



PS

1SNK160127F0014

PS crimping tools

Description

- Crimp flexible conductors equipped with ferrules from 0.08 to 10 mm² 28 AWG to 7 AWG,
- Semi-automatic crimping tool.

Ordering details

Description	Color	Type	Part Number	Pkg qty	Weight (1 pce) g
180 mm 7.09 in length		PS-3	1SNK900650R0000	1	380.00

Technical data valid for copper conductors only.

End sections

PI-Spring terminal block accessories



1SNK160233V0014

EK2.5

EK2.5 end sections

Description

- Unique dark grey color that fits all terminal blocks colours and ease the identification of circuits within your terminal block assemblies,
- Compatible with ZK2.5, ZK2.5-PE, ZK4, ZK4-PE, ZK6 and ZK6-PE PI-Spring screwless terminal blocks.

Ordering details

Description	Color	Type	Part Number	Pkg qty	Weight (1 pce) g
2 mm 0.079 in spacing	Dark grey	EK2.5	1SNK705910R0000	20	1.80



1SNK160234V0014

EK2.5-3P

EK2.5-3P end sections

Description

- Unique dark grey color that fits all terminal blocks colours and ease the identification of circuits within your terminal block assemblies,
- Compatible with ZK2.5-3P, ZK2.5-PE-3P, ZK4-3P, ZK4-PE-3P, ZK2.5-S..., ZK2.5-SP and ZK2.5-SF... PI-Spring screwless terminal blocks.

Ordering details

Description	Color	Type	Part Number	Pkg qty	Weight (1 pce) g
2 mm 0.079 in spacing	Dark grey	EK2.5-3P	1SNK705911R0000	20	2.40



1SNK160235V0014

EK2.5-4P

EK2.5-4P end sections

Description

- Unique dark grey color that fits all terminal blocks colours and ease the identification of circuits within your terminal block assemblies,
- Compatible with ZK2.5-4P, ZK2.5-PE-4P, ZK4-4P and ZK4-PE-4P PI-Spring screwless terminal blocks.

Ordering details

Description	Color	Type	Part Number	Pkg qty	Weight (1 pce) g
2 mm 0.079 in spacing	Dark grey	EK2.5-4P	1SNK705912R0000	20	2.70

Main technical data

Material specifications	Insulating material	Polyamide			
	Flammability	V0			
	NF F 16 101	I2F2			
Ambient temperature min/max	Service IEC 60068-2-1	-55 ... +110 °C	-67 ... +230 °F		
	Storage	-55 ... +110 °C	-67 ... +230 °F		
	Installing	-5 ... +40 °C	+23 ... +104 °F		

All the main technical data provided are "manufacturer" values.

RoHS					
------	--	--	--	--	--

Technical data valid for copper conductors only.

1SNK160064S0201

End sections

PI-Spring terminal block accessories



1SNK160339V0014

EK2.5-S-4P

EK2.5-S-4P end sections

Description

- Unique dark grey color that fits all terminal blocks colours and ease the identification of circuits within your terminal block assemblies,
- Compatible with ZK2.5-S-4P, ZK2.5-SP-4P, ZK2.5-CH-4P... PI-Spring screwless terminal blocks.

Ordering details

Description	Color	Type	Part Number	Pkg qty	Weight (1 pce) g
2 mm 0.079 in spacing	Dark grey	EK2.5-S-4P	1SNK705913R0000	20	2.94

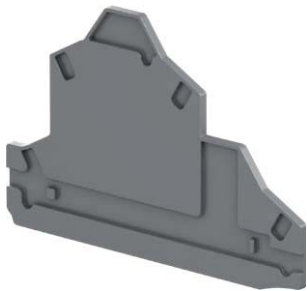

1SNK160237V0014

EK2.5-D2

EK2.5-D2 end sections

Description

- Compatible with ZK2.5-D2, ZK2.5-D2-PE, ZK2.5-D1 and ZK2.5-D1-PE PI-Spring screwless terminal blocks.

Ordering details

Description	Color	Type	Part Number	Pkg qty	Weight (1 pce) g
2 mm 0.079 in spacing	Dark grey	EK2.5-D2	1SNK705960R0000	20	3.40



1SNK160346V0014

EK2.5-T3

EK2.5-T3 end sections

Description

- Compatible with ZK2.5-T3, ZK2.5-T1, ZK2.5-T1-PE, ZK2.5-L-L-PE and ZK2.5-L-N-PE PI-Spring screwless terminal blocks.

Ordering details

Description	Color	Type	Part Number	Pkg qty	Weight (1 pce) g
0.8 mm 0.031 in spacing	Dark grey	EK2.5-T3	1SNK705961R0000	20	4.76

Main technical data

Material specifications	Insulating material	Polyamide			
	Flammability	V0			
	NF F 16 101	I2F2			
Ambient temperature min/max	Service IEC 60068-2-1	-55 ... +110 °C	-67 ... +230 °F		
	Storage	-55 ... +110 °C	-67 ... +230 °F		
	Installing	-5 ... +40 °C	+23 ... +104 °F		

All the main technical data provided are "manufacturer" values.

	RoHS				
	RoHS				

Technical data valid for copper conductors only.

End sections

PI-Spring terminal block accessories



1SNK160238V0014

EK6-3P

EK6-3P end sections

Description

– Compatible with ZK6-3P and ZK6-PE-3P PI-Spring screwless terminal blocks.

Ordering details

Description	Color	Type	Part Number	Pkg qty	Weight (1 pce) g
2 mm 0.079 in spacing	Dark grey	EK6-3P	1SNK708911R0000	20	2.80

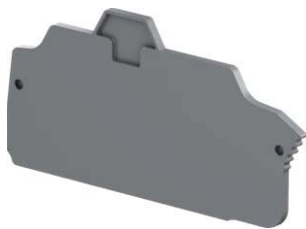

1SNK160238V0014

EK10

EK10 end sections

Description

– Compatible with ZK10, ZK10-PE, ZK16 and ZK16-PE PI-Spring screwless terminal blocks.

Ordering details

Description	Color	Type	Part Number	Pkg qty	Weight (1 pce) g
2 mm 0.079 in spacing	Dark grey	EK10	1SNK710910R0000	20	3.30



1SNK160318V0014

EK10-3P

EK10-3P end sections

Description

– Unique dark grey color that fits all terminal blocks colours and ease the identification of circuits within your terminal block assemblies,
– Compatible with ZK10-3P, ZK10-PE-3P, ZK16-3P, ZK16-PE-3P... PI-Spring screwless terminal blocks.

Ordering details

Description	Color	Type	Part Number	Pkg qty	Weight (1 pce) g
2 mm 0.079 in spacing	Dark grey	EK10-3P	1SNK710911R0000	20	4.5

Main technical data

Material specifications	Insulating material	Polyamide			
	Flammability	V0			
	NF F 16 101	I2F2			
Ambient temperature min/max	Service IEC 60068-2-1	-55 ... +110 °C	-67 ... +230 °F		
	Storage	-55 ... +110 °C	-67 ... +230 °F		
	Installing	-5 ... +40 °C	+23 ... +104 °F		

All the main technical data provided are "manufacturer" values.

RoHS					
RoHS					

Technical data valid for copper conductors only.

1SNK160095S0201

Circuit separators

PI-Spring terminal blocks accessories



1SNK1502400014

CS-R2

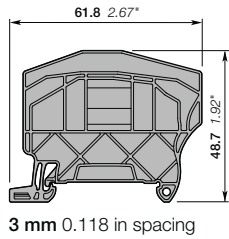

CS-R2 circuit separators

Description

- Compact circuits separator solution (only 3mm spacing) which provides a convenient visual identification of the several circuits within terminal assemblies,
- Unique top marking possibility that can replace the conventional solution of "end stop with label holder" for demanding applications with high space constraints, - Compatible with all PI-spring feed-through and ground terminal blocks up to 8 mm spacing,
- Mounting on DIN3-TH35 rail.

Ordering details

Description	Color	Type	Part Number	Pkg qty	Weight (1 pce) g
3 mm 0.118 in spacing	Dark grey <input checked="" type="checkbox"/>	CS-R2	1SNK900106R0000	20	3.80

Main technical data

Material specifications	Insulating material	Polyamide			
	Flammability	V0			
	NF F 16 101	I2F2			
Ambient temperature min/max	Service IEC 60068-2-1	-55 ... +110 °C	-67 ... +230 °F		
	Storage	-55 ... +110 °C	-67 ... +230 °F		
	Installing	-5 ... +40 °C	+23 ... +104 °F		

All the main technical data provided are "manufacturer" values

	RoHS <input checked="" type="checkbox"/>				
	RoHS				

Accessories

Description	Color	Type	Part Number	Pkg qty	Weight (1 pce) g
Terminal block markers	White <input type="checkbox"/>	MG-CPM 13 41791	1SNB041791R0612	1680	0.27
Labels	Yellow <input checked="" type="checkbox"/>	MG-VYT 46415	1SNB046415R0615	5250	0.04
	White <input type="checkbox"/>	MG-VYT 46915	1SNB046915R0615	5250	0.05
Blank card	In polycarbonate				
	Blank card	MC612	1SNK15000R0000	22	10.00
Universal wire markers holder	Grey <input type="checkbox"/>	UMH	1SNK900611R0000	10	0.20

Technical data valid for copper conductors only.



1SNK160241V0014

CS-R3

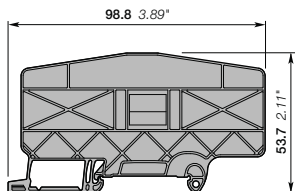

3 mm 0.118 in spacing

CS-R3 circuit separators

Description

- Compact circuits separator solution (only 3mm spacing) which provides a convenient visual identification of the several circuits within terminal assemblies,
- Unique top marking possibility that can replace the conventional solution of "end stop with label holder" for demanding applications with high space constraints,
- Compatible with all single deck PI-spring terminal blocks and ZS10-ST...terminal blocks ,
- Mounting on DIN3-TH35 rail.

Ordering details

Description	Color	Type	Part Number	Pkg qty	Weight (1 pce) g
3 mm 0.118 in spacing	Dark grey <input checked="" type="checkbox"/>	CS-R3	1SNK900107R0000	20	6.40

Main technical data

Material specifications	Insulating material	Polyamide			
	Flammability	V0			
	NF F 16 101	I2F2			
Ambient temperature min/max	Service IEC 60068-2-1	-55 ... +110 °C	-67 ... +230 °F		
	Storage	-55 ... +110 °C	-67 ... +230 °F		
	Installing	-5 ... +40 °C	+23 ... +104 °F		

All the main technical data provided are "manufacturer" values

RoHS									
<input checked="" type="checkbox"/>									

Accessories

Description	Color	Type	Part Number	Pkg qty	Weight (1 pce) g	
Terminal block markers	White <input type="checkbox"/>	MG-CPM 13 41790	1SNB041790R0512	1960	0.23	
		MG-CPM 13 41791	1SNB041791R0612	1680	0.27	
Labels	Yellow <input checked="" type="checkbox"/>	MG-VYT 46415	1SNB046415R0615	5250	0.04	
		MG-VYT 46915	1SNB046915R0615	5250	0.05	
Blank card	White <input type="checkbox"/>	In polycarbonate	MC512	1SNK140000R0000	22	9.00
		Blank card	MC512PA	1SNK149999R0000	20	10.00
		In polycarbonate	MC612	1SNK150000R0000	22	10.00
		Blank card	MC612PA	1SNK159999R0000	20	11.00
Universal wire markers holder 5.2 mm 0.205 in spacing	Grey <input type="checkbox"/>	UMH	1SNK900611R0000	10	0.20	

Technical data valid for copper conductors only.

Shield connectors

PI-Spring terminal block accessories



1SNK1600627R0014

SHBP/SHB

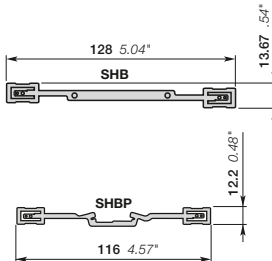

SHBP/SHB shield connectors for PI-Spring terminal blocks

Description

- Ensure the continuity of your shield connection,
- Various connection solutions available: RILS cable ties, soldering, quick-connect.

Ordering details

Description	Color	Type	Part Number	Pkg qty	Weight (1 pce) g
Compatible with ZK2.5 and ZK2.5-S terminal blocks		SHBP	1SNK900601R0000	20	4.10
Compatible with ZS and ZK double deck terminal blocks:		SHB	1SNK900602R0000	20	4.90

Main technical data

Material specifications	Insulating material				
	Flammability				
Ambient temperature min/max	NF F 16 101				
	Service IEC 60068-2-1	-55 ... +110 °C	-67 ... +230 °F		
	Storage	-55 ... +110 °C	-67 ... +230 °F		
	Installing	-5 ... +40 °C	+23 ... +104 °F		

SHBP	IEC	UL - CSA	Ex e
Rated voltage	100 V		50 V

All the main technical data provided are "manufacturer" values

	RoHS								
	RoHS								

Accessories for screw clamp and PI-Spring terminal blocks

Description	Color	Type	Part Number	Pkg qty	Weight (1 pce) g
Cable ties	For SNK shield connector	RILS	1SNK900627R0000	10	0.30

Mounting instructions



- SHBS is directly fixed on the terminal block,
- SHB is fixed on the ES4-D2 end section,
- SHBP is directly fixed on the terminal block,
- Connect the cable shielding on the shielding connector with:
 - RILS cable ties,
 - quick-connect (the shield connector needs to be prepared),
 - soldering iron.

Technical data valid for copper conductors only.

End sections

Screw clamp terminal block accessories



1SNK161019P0014

ES4

ES4 end sections

Description

- Unique dark grey color that fits all terminal blocks colours and ease the identification of circuits within your terminal block assemblies,
- Compatible with feed-through, ground and disconnect screw clamp terminal blocks.

Ordering details

Description	Color	Type	Part Number	Pkg qty	Weight (1 pce) g
2.2 mm 0.087 in spacing	Dark grey	ES4	1SNK505910R0000	20	2.20



1SNK160229W0014

ES6-3S

ES6-3S end sections

Description

- Compatible with ZS6-3S and ZS6-3S-PE terminal blocks.

Ordering details

Description	Color	Type	Part Number	Pkg qty	Weight (1 pce) g
2.2 mm 0.087 in spacing	Dark grey	ES6-3S	1SNK505912R0000	20	2.50



1SNK160230V0014

ES6-4S

ES6-4S end sections

Description

- Compatible with ZS6-4S, ZS6-4S-PE, ZS6-S-4S-T2 and ZS4-PE-R2 terminal blocks.

Ordering details

Description	Color	Type	Part Number	Pkg qty	Weight (1 pce) g
2.2 mm 0.087 in spacing	Dark grey	ES6-4S	1SNK505911R0000	20	3.10



1SNK161012P0014

ES4-D2

ES4-D2 end sections

Description

- Unique dark grey color that fits all terminal blocks colours and ease the identification of circuits within your terminal block assemblies,
- Compatible with double deck screw clamp terminal blocks

Ordering details

Description	Color	Type	Part Number	Pkg qty	Weight (1 pce) g
2.55 mm 0.100 in spacing	Dark grey	ES4-D2	1SNK505960R0000	20	4.10

Main technical data

Material specifications	Insulating material	Polyamide			
	Flammability	V0			
	NF F 16 101	I2F2			
Ambient temperature min/max	Service IEC 60068-2-1	-55 ... +110 °C	-67 ... +230 °F		
	Storage	-55 ... +110 °C	-67 ... +230 °F		
	Installing	-5 ... +40 °C	+23 ... +104 °F		

All the main technical data provided are "manufacturer" values.

RoHS					
RoHS					

Technical data valid for copper conductors only.

1SNK160061S0201

End sections

Screw clamp terminal block accessories

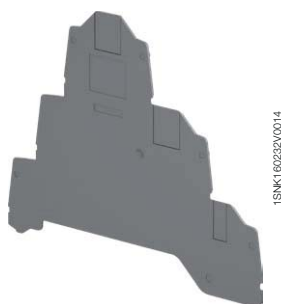

1SNK16023V0014

ES4-T3

ES4-T3 end sections

Description

- Compatible with ZS4-T3 terminal block.

Ordering details

Description	Color	Type	Part Number	Pkg qty	Weight (1 pce) g
0.8 mm 0.031 in spacing	Dark grey	ES4-T3	1SNK505961R0000	20	4.20

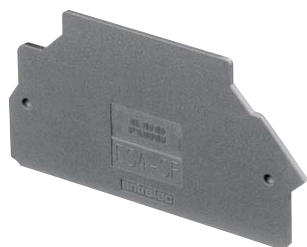

1SNK161026F0014

ES4-SF

ES4-SF end sections

Description

- Compatible with fuse ZS4-SF1... and disconnect screw clamp terminal blocks ZS4-S-R3.

Ordering details

Description	Color	Type	Part Number	Pkg qty	Weight (1 pce) g
1.5 mm 0.059 in spacing	Dark grey	ES4-SF	1SNK508960R0000	20	1.80

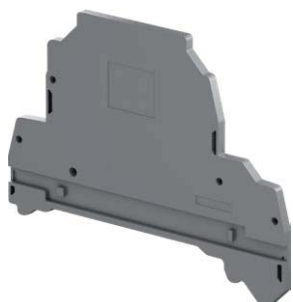

1SNK160231W0014

ES4-D2-SF1

ES4-D2-SF1 end sections

Description

- Compatible with ZS4-D2-SF1 ... terminal blocks.

Ordering details

Description	Color	Type	Part Number	Pkg qty	Weight (1 pce) g
2.5 mm 0.098 in spacing	Dark grey	ES4-D2-SF1	1SNK508911R0000	20	5.00



1SNK16102ZF0014

ES10-ST

ES10-ST end sections

Description

- Unique dark grey color that fits all test disconnect terminal blocks ZS10-ST... and ease the identification of circuits within your terminal block assemblies,
- Also compatible with ZS10-R1 and ZS10-PE-R1.

Ordering details

Description	Color	Type	Part Number	Pkg qty	Weight (1 pce) g
2 mm 0.079 in spacing	Dark grey	ES10-ST	1SNK508910R0000	20	3.5

Accessories

Description	Color	Type	Part Number	Pkg qty	Weight (1 pce) g
Circuit separators	Dark grey	CS	1SNK900101R0000	20	0.20

Main technical data

Material specifications	Insulating material	Polyamide			
	Flammability	V0			
	NF F 16 101	I2F2			
Ambient temperature min/max	Service IEC 60068-2-1	-55 ... +110 °C	-67 ... +230 °F		
	Storage	-55 ... +110 °C	-67 ... +230 °F		
	Installing	-5 ... +40 °C	+23 ... +104 °F		

All the main technical data provided are "manufacturer" values.

RoHS	RoHS				
------	------	--	--	--	--

Technical data valid for copper conductors only.

1SNK160062S0201

Screw jumper bars

Screw clamp terminal block accessories



1SNK1602 12F0014

JB8
8 mm 0.315 in spacing

Mounting instructions

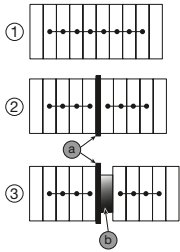

- 1 - Rated voltage: 160 V (IEC) / Not authorized (UL)
 - 2 - Rated voltage: 320 V (IEC) / Not authorized (UL)
 - 3 - Rated voltage: 1000 V (IEC) / 300 V (UL)
- a - End section ES10-ST
b - End stop BAZ1

JB8 jumper bars

Description

Insulated jumper bar with screw mounting.

Ordering details

Description		Color	Type	Part Number	Pkg qty	Weight (1 pce) g
8 mm 0.315 in spacing	2 poles	Orange	JB8-2-R1	1SNK908902R0000	10	7.6
	3 poles		JB8-3-R1	1SNK908903R0000	10	11.6
	4 poles		JB8-4-R1	1SNK908904R0000	10	15.5
	5 poles		JB8-5-R1	1SNK908905R0000	10	19.4
	10 poles		JB8-10-R1	1SNK908910R0000	10	39.00

Main technical data

Material specifications	Insulating material Flammability NF F 16 101	Polyamide V0 I2F3	Rail	
Ambient temperature min/max	Service IEC 60068-2-1	-55 ... +110 °C -67 ... +230 °F	Tool	Flat screwdriver Ø 3.5 mm Ø 0.138 in
	Storage	-55 ... +110 °C -67 ... +230 °F	Torque	0.7 Nm ± 0.1 6.2 lb.in ± 0.88
	Installing	-5 ... +40 °C +23 ... +104 °F		
Rated current		IEC 50 A	UL - CSA 51 A	Ex e
Rated voltage	Standard use	160 V		
	Alternated poles			Not authorized
Impulse withstand voltage				
Protection		IP20	NEMA 1	
All the main technical data provided are "manufacturer" values				
	RoHS RoHS			

Technical data valid for copper conductors only.

Screw jumper bars

Screw clamp terminal block accessories



1SNK16012AF0014

JB16
16 mm 0.630 in spacing

Mounting instructions



- With flat pliers, cut out the partitions on the terminal block insulating body. Be careful to not cut out the jumpered terminal blocks partitions at both ends of the assembly in order to maintain the IP20, Nema1 protection and insulation.
- Install the jumper bar with the recommended tool and torque.

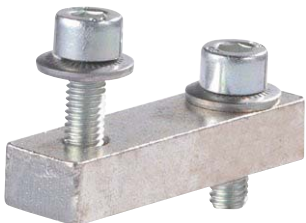

1SNK160100F0014

JB22
22 mm 0.866 in spacing

Mounting instructions



- With flat pliers, cut out the partitions on the terminal block insulating body. Be careful to not cut out the jumpered terminal blocks partitions at both ends of the assembly in order to maintain the IP20, Nema1 protection and insulation.
- Install the jumper bar with the recommended tool and torque.

JB16 jumper bars

Description

Insulated jumper bar with screw mounting.

Ordering details

Description		Color	Type	Part Number	Pkg qty	Weight (1 pce) g
16 mm 0.630 in spacing	2 poles	Orange	JB16-2	1SNK916302R0000	10	10.00
	3 poles		JB16-3	1SNK916303R0000	10	16.00
	4 poles		JB16-4	1SNK916304R0000	10	22.00
	5 poles		JB16-5	1SNK916305R0000	10	28.00
	10 poles		JB16-10	1SNK916310R0000	10	56.60

Main technical data

Material specifications	Insulating material	Polyamide		Rail	
	Flammability	V0		Tool	Flat screwdriver Ø 5.5 mm Ø 0.217 in
	NF F 16 101	I2F3			
Ambient temperature min/max	Service IEC 60068-2-1	-55 ... +110 °C	-67 ... +230 °F	Torque	1.2 Nm ± 0.1 10.6 lb.in ± 0.885
	Storage	-55 ... +110 °C	-67 ... +230 °F		
	Installing	-5 ... +40 °C	+23 ... +104 °F		
Rated current		IEC 125 A	UL - CSA 150 A	Ex e	
Rated voltage	Standard use	1000 V	600 V		
		Alternated poles		Not authorized	
Impulse withstand voltage		8000 V			
Protection		IP20	NEMA 1		
All the main technical data provided are "manufacturer" values					
	RoHS				

JB22 jumper bars

Description

Screw jumper bars

Ordering details

Description		Color	Type	Part Number	Pkg qty	Weight (1 pce) g
22 mm 0.866 in spacing	2 poles		JB22-2	1SNK922302R0000	5	27.00
	3 poles		JB22-3	1SNK922303R0000	5	43.30
	5 poles		JB22-5	1SNK922305R0000	5	76.10
	10 poles		JB22-10	1SNK922310R0000	5	157.40

Main technical data

Material specifications	Insulating material	Polyamide		Rail	
	Flammability	V0		Tool	Allen key Ø 4 mm Ø 0.157 in
	NF F 16 101	I2F3			
Ambient temperature min/max	Service IEC 60068-2-1	-55 ... +110 °C	-67 ... +230 °F	Torque	2 Nm ± 0.4 17.7 lb.in ± 3.54
	Storage	-55 ... +110 °C	-67 ... +230 °F		
	Installing	-5 ... +40 °C	+23 ... +104 °F		
Rated current		IEC 192 A	UL - CSA 175 A	Ex e	
Rated voltage	Standard use	1000 V	600 V	630 V	
		Alternated poles		Not authorized	
Impulse withstand voltage		8000 V			
Protection		IP20			
All the main technical data provided are "manufacturer" values					
	RoHS				

Technical data valid for copper conductors only.

Screw jumper bars

Screw clamp terminal block accessories

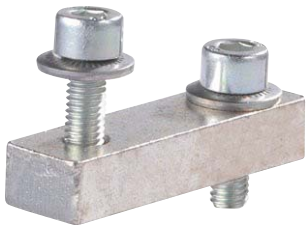

1SNK160100P0014

JB26
26 mm 1.024 in spacing

JB26 jumper bars

Description

Screw jumper bars

Ordering details

Description		Color	Type	Part Number	Pkg qty	Weight (1 pce) g
26 mm 1.02 in spacing	2 poles		JB26-2	1SNK926302R0000	5	41.20
	3 poles		JB26-3	1SNK926303R0000	5	65.70
	5 poles		JB26-5	1SNK926305R0000	5	115.70
	10 poles		JB26-10	1SNK926310R0000	5	241.50

Mounting instructions

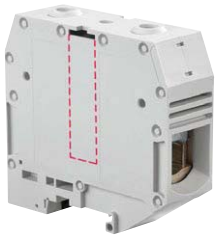

- With flat pliers, cut out the partitions on the terminal block insulating body. Be careful to not cut out the jumpered terminal blocks partitions at both ends of the assembly in order to maintain the IP20, Nema1 protection and insulation,
- Install the jumper bar with the recommended tool and torque.

Main technical data

Material specifications	Insulating material			Rail		
	Flammability			Tool		Allen key Ø 4 mm Ø 0.157 in
Ambient temperature min/max	Service IEC 60068-2-1	-55 ... +110 °C	-67 ... +230 °F	Torque		2 Nm ± 0.4 17.7 lb.in ± 3.54
	Storage	-55 ... +110 °C	-67 ... +230 °F			
	Installing	-5 ... +40 °C	+23 ... +104 °F			
		IEC	UL - CSA	Ex e		
Rated current		232 A	230 A			
Rated voltage	Standard use	1000 V	600 V	630 V		
	Alternated poles			Not authorized		
Impulse withstand voltage		8000 V				
Protection		IP20				
All the main technical data provided are *manufacturer* values						
RoHS						
RoHS						

Technical data valid for copper conductors only.

Screw jumper bars

Screw clamp terminal block accessories

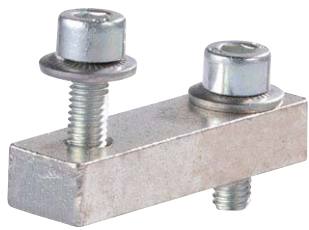

1SNK160100F0014

BJMI31

31 mm 1.22 in spacing

Mounting instructions



- With flat pliers, cut out the partitions on the terminal block insulating body. Be careful not to cut out the jumpered terminal blocks partitions at both ends of the assembly in order to maintain the IP20, Nema1 protection and insulation,
- Install the jumper bar with the recommended tool and torque.

BJMI31 jumper bars

Description

Screw jumper bars

Ordering details

Description		Color	Type	Part Number	Pkg qty	Weight (1 pce) g
31mm 1.220 in spacing	2 poles		BJMI31.2	1SNA206053R0700	1	120.00
	3 poles		BJMI31.3	1SNA206054R0000	1	190.00

Main technical data

Material specifications	Insulating material			Rail		
	Flammability			Tool		Allen key Ø 5 mm
Ambient temperature min/max	Service IEC 60068-2-1	-55 ... +110 °C	-67 ... +230 °F	Torque		Ø 0.196 in 3 Nm ± 0.4 26.55 lb.in ± 3.54
	Storage	-55 ... +110 °C	-67 ... +230 °F			
	Installing	-5 ... +40 °C	+23 ... +104 °F			
Rated current	Standard use	IEC	UL - CSA	Ex e		
		309 A	445 A			
Rated voltage	Standard use	1000 V	600 V			
		Alternated poles			Not authorized	
Impulse withstand voltage		8000 V				
Protection		IP20				

All the main technical data provided are "manufacturer" values

RoHS	RoHS	RoHS	RoHS	RoHS	RoHS	RoHS	RoHS	RoHS	RoHS

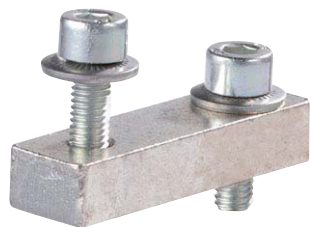

1SNK160100F0014

BJMI36

36 mm 1.42 in spacing

Mounting instructions

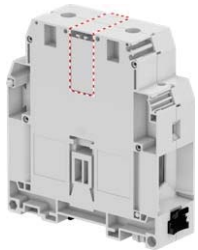

- With flat pliers, cut out the partitions on the terminal block insulating body. Be careful not to cut out the jumpered terminal blocks partitions at both ends of the assembly in order to maintain the IP20, Nema1 protection and insulation,
- Install the jumper bar with the recommended tool and torque.

BJMI36 jumper bars

Description

Screw jumper bars

Ordering details

Description		Color	Type	Part Number	Pkg qty	Weight (1 pce) g
36mm 1.417 in spacing	2 poles		BJMI36.2	1SNA206126R2500	1	170.00
	3 poles		BJMI36.3	1SNA206223R0600	1	260.00

Main technical data

Material specifications	Insulating material			Rail		
	Flammability			Tool		Allen key Ø 5 mm
Ambient temperature min/max	Service IEC 60068-2-1	-55 ... +110 °C	-67 ... +230 °F	Torque		Ø 0.196 in 3 Nm ± 0.4 26.55 lb.in ± 3.54
	Storage	-55 ... +110 °C	-67 ... +230 °F			
	Installing	-5 ... +40 °C	+23 ... +104 °F			
Rated current	Standard use	IEC	UL - CSA	Ex e		
		415 A	620 A			
Rated voltage	Standard use	1000 V	600 V			
		Alternated poles			Not authorized	
Impulse withstand voltage		8000 V				
Protection		IP20				

All the main technical data provided are "manufacturer" values

RoHS	RoHS	RoHS	RoHS	RoHS	RoHS	RoHS	RoHS	RoHS	RoHS

Technical data valid for copper conductors only.

Lateral jumper bars

Screw clamp terminal block accessories



1SNK160112PC014

PC8

8 mm 0.315 in spacing

Mounting instructions for ZS10-ST...

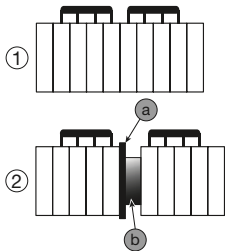

1 - Rated voltage: 630 V (IEC) / 150 V (UL)

2 - Rated voltage: 630 V (IEC) / 300 V (UL)

a - End section ES10-ST

b - End stop BAZ1

PC8 lateral jumper bars

Description

IP20 Comb jumper bars,

- direct insertion in the screw clamp before tightening the screws, above the eventual conductor (if conductor used with ferrule, we recommend the use of long ferrule for optimized mounting ergonomony with test disconnect terminal blocks),
- Multiple versions available in pre-cut poles for test disconnect terminal blocks applications.

Ordering details

Description	Color	Type	Part Number	Pkg qty	Weight (1 pce) g
Lateral jumper bars					
8 mm 0.315 in spacing	Black	PC8-2	1SNA116538R1700	10	3.00
2 poles		PC8-3	1SNA116539R1000	10	4.00
3 poles		PC8-4	1SNA116540R2500	10	6.00
4 poles		PC8-10	1SNA163313R2400	10	14.00
10 poles					

Lateral jumper bars pre-cut poles

Description	Color	Type	Part Number	Pkg qty	Weight (1 pce) g
Lateral jumper bars pre-cut poles					
8 mm 0.315 in spacing	Black	PC8-R1	1SNA400711R0600	10	6.60
4/6 poles		PC8-R2	1SNA400712R0700	10	7.80
4/8 poles		PC8-R3	1SNA400713R0000	10	9.00
4/10 poles		PC8-R4	1SNA400724R0300	10	4.50
3/4 poles		PC8-R5	1SNA400842R0000	10	6.60
4/7 poles		PC8-R6	1SNA400843R0000	10	6.60
2/3 poles		PC8-R7	1SNA400849R0000	10	6.60
4/6 poles		PC8-R8	1SNA400850R0000	10	7.80
4/8 poles					

Main technical data

Material specifications	Insulating material	Polyamide			
	Flammability	V0			
	NF F 16 101	I2F3			
Ambient temperature min/max	Service IEC 60068-2-1	-55 ... +110 °C	-67 ... +230 °F		
	Storage	-55 ... +110 °C	-67 ... +230 °F		
	Installing	-5 ... +40 °C	+23 ... +104 °F		

All the main technical data provided are *manufacturer* values

RoHS
RoHS



1SNK160537PC014

PC81

8 mm 0.315 in spacing

PC81 lateral jumper bars

Description

Comb-type jumper bar, allows the connection of consecutive blocks or not by one compression clamp connection.

Ordering details

Description	Color	Type	Part Number	Pkg qty	Weight (1 pce) g
8 mm 0.315 in spacing	Grey	PC81-10	1SNA173523R1100	10	5.00
10 poles					

Main technical data

Material specifications	Insulating material	Brass/polyamide			
	Flammability	V0			
	NF F 16 101	I2F3			
Ambient temperature min/max	Service IEC 60068-2-1	-55 ... +110 °C	-67 ... +230 °F		
	Storage	-55 ... +110 °C	-67 ... +230 °F		
	Installing	-5 ... +40 °C	-23 ... +104 °F		

All the main technical data provided are *manufacturer* values

RoHS
RoHS

Technical data valid for copper conductors only.

Circuit separators

Screw clamp terminal block accessories



1SNK160002R0014

CS
0 mm 0 in spacing

Mounting instructions



CS circuit separators

Description

- The CS circuit separator avoids the derating of terminal blocks when cut jumper bars JB are used,
- Compatible with feed-through terminal blocks up to 16 mm² 4 AWG,
- Without spacing loss.

Ordering details

Description	Color	Type	Part Number	Pkg qty	Weight (1 pce) g
0 mm 0 in spacing	Dark grey	CS	1SNK900101R0000	20	0.20

Main technical data

Material specifications	Insulating material	Polyamide			
	Flammability	V0			
Ambient temperature min/max	NF F 16 101	I2F2			
	Service IEC 60068-2-1	-55 ... +110 °C	-67 ... +230 °F		
	Storage	-55 ... +110 °C	-67 ... +230 °F		
	Installing	-5 ... +40 °C	+23 ... +104 °F		
All the main technical data provided are "manufacturer" values					
RoHS					



1SNK160003R0014

CS-R1

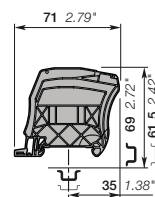

3 mm 0.118 in spacing

CS-R1 circuit separators

Description

- Ease the visual identification of the several circuits within your terminal block assemblies,
- Compatible with feed-through terminal blocks up to 35 mm² 0 AWG,
- Intermediate cover holder for CO protective cover,
- Mounting on DIN3-TH35 rail.

Ordering details

Description	Color	Type	Part Number	Pkg qty	Weight (1 pce) g
3 mm 0.118 in spacing	Dark grey	CS-R1	1SNK900103R0000	20	5.20

Main technical data

Material specifications	Insulating material	Polyamide			
	Flammability	V0			
Ambient temperature min/max	NF F 16 101	I2F2			
	Service IEC 60068-2-1	-55 ... +110 °C	-67 ... +230 °F		
	Storage	-55 ... +110 °C	-67 ... +230 °F		
	Installing	-5 ... +40 °C	+23 ... +104 °F		
All the main technical data provided are "manufacturer" values					
RoHS					

Mounting instructions



Accessories

Description	Color	Type	Part Number	Pkg qty	Weight (1 pce) g	
Terminal block markers	White	MG-CPM 13 41790	1SNB041790R0512	1960	0.23	
Blank card		In polycarbonate	MC512	1SNK140000R0000	22	9.00
		Blank card	MC512PA	1SNK149999R0000	20	10.00
Universal wire markers holder	Grey	UMH	1SNK900611R0000	10	0.20	

Technical data valid for copper conductors only.

Shield connectors

Screw clamp terminal block accessories



SHBS/SHB

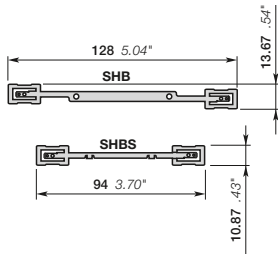

SHBS/SHB shield connectors

Description

- Ensure the continuity of your shield connection,
- Various connection solutions available: RILS cable ties, soldering, quick-connect.

Ordering details

Description	Color	Type	Part Number	Pkg qty	Weight (1 pce) g
Compatible with ZS feed-through terminal blocks		SHBS	1SNK900600R0000	20	3.50
Compatible with ZS and ZK double deck terminal blocks		SHB	1SNK900602R0000	20	4.90

Main technical data

Material specifications	Insulating material	Flammability	NF F 16 101
Ambient temperature min/max	Service IEC 60068-2-1	-55 ... +110 °C	-67 ... +230 °F
	Storage	-55 ... +110 °C	-67 ... +230 °F
	Installing	-5 ... +40 °C	+23 ... +104 °F

SHBS	IEC	UL - CSA	Ex e
Rated voltage	320 V		125 V

All the main technical data provided are "manufacturer" values

RoHS	RoHS

Accessories for screw clamp and PI-Spring terminal blocks

Description	Color	Type	Part Number	Pkg qty	Weight (1 pce) g
Cable ties	For SNK shield connector	RILS	1SNK900627R0000	10	0.30

Mounting instructions



- SHBS is directly fixed on the terminal block,
- SHB is fixed on the ES4-D2 end section,
- SHBP is directly fixed on the terminal block,
- Connect the cable shielding on the shielding connector with:
- RILS cable ties,
- quick-connect (the shield connector needs to be prepared),
- soldering iron.

Technical data valid for copper conductors only.

PL protecting covers

Screw clamp terminal block accessories



1SNK16006R0014

PL

Mounting instructions



- The mounting of the PL does not require a screwdriver,
- The dismounting of the PL requires a screwdriver DIA .4 mm 0.160 in, the screwdriver must be positioned in the cover centered hole.

Description

- Prohibit access to the screw clamps,
- Indicate live circuits.

Ordering details

Description	Color	Type	Part Number	Pkg qty	Weight (1 pce) g
5.2 mm 0.205 in spacing	Transparent <input checked="" type="checkbox"/>	PL5	1SNK900618R0000	10	1.50
6 mm 0.236 in spacing		PL6	1SNK900619R0000	10	1.80
8 mm 0.315 in spacing		PL8	1SNK900620R0000	10	2.60
10 mm 0.394 in spacing		PL10	1SNK900621R0000	10	3.10
16 mm 0.630 in spacing		PL16	1SNK900622R0000	10	4.60

Main technical data

Material specifications	Insulating material	Polycarbonate	Mounting instructions		
Flammability	NF F 16 101	V2	Tool		Flat screwdriver Ø 4 mm Ø 0.157 in
Ambient temperature min/max	Service IEC 60068-2-1	-55 ... +110 °C -67 ... +230 °F			
	Storage	-55 ... +110 °C -67 ... +230 °F			
	Installing	-5 ... +40 °C +23 ... +104 °F			

All the main technical data provided are "manufacturer" values

RoHS									
	RoHS								

Technical data valid for copper conductors only.

Protecting covers

Screw clamp terminal block accessories



1SNK160110FC0014

CO

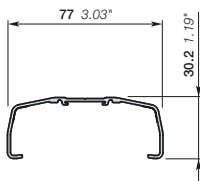

CO protecting covers

Description

- Restrict access to your assembly with the protecting cover CO installed with KCO mounting kit (2 end stops, 2 sealing accessories),
- Compatible with SNK feed-through terminal blocks up to 35 mm² 0 AWG.

Ordering details

Description	Color	Type	Part Number	Pkg qty	Weight (1 pce)
1 m 39.4 in length	Transparent <input checked="" type="checkbox"/>	CO	1SNK900604R0000	1	300.00

Main technical data

Material specifications	Insulating material	PVC			
	Flammability	V0			
Ambient temperature min/max	Service IEC 60068-2-1	-55 ... +80 °C	-67 ... +176 °F		
	Storage	-55 ... +80 °C	-67 ... +176 °F		
	Installing	-5 ... +40 °C	+23 ... +104 °F		

All the main technical data provided are "manufacturer" values

RoHS
RoHS

Accessories

Description	Color	Type	Part Number	Pkg qty	Weight (1 pce)
Protecting cover kits	Dark grey <input checked="" type="checkbox"/>	KCO	1SNK900624R0000	1	47.80
Label	White <input type="checkbox"/>	PAM43020	1SNA235106R2600	20	27.00

Mounting instructions



- Restrict access to the circuit by sealing the cover:
- Drill on the CO center line at 5 mm 0.197 in from the extremity with 5 mm 0.197 in diameter drill,
 - Pass the sealing collar through the CO and KCO holes.



1SNK160144F0014

KCO

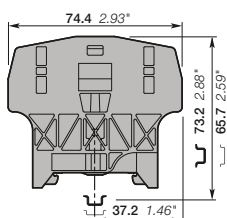

KCO protecting cover kits

Description

- Mount your protecting cover with the KCO versatile mounting kit (2 end stops, 2 sealing accessories):
- Maintain the cover,
 - Reliably seal the access to the terminal assembly if needed,
 - Use it as well as an end stop.

Ordering details

Description	Color	Type	Part Number	Pkg qty	Weight (1 pce)
Mounting kit for cover CO	Dark grey <input checked="" type="checkbox"/>	KCO	1SNK900624R0000	1	47.80

Main technical data

Material specifications	Insulating material	Polyamide		Rail	G32, TH 35-7.5, TH 36-15, TH 15-5.5
	Flammability	V0		Tool	Flat screwdriver Ø 4 mm Ø 0.157 in
Ambient temperature min/max	Service IEC 60068-2-1	-55 ... +110 °C	-67 ... +230 °F		
	Storage	-55 ... +110 °C	-67 ... +230 °F		
	Installing	-5 ... +40 °C	+23 ... +104 °F		

All the main technical data provided are "manufacturer" values

RoHS
RoHS

Technical data valid for copper conductors only.

Short circuit bridges

Screw clamp terminal block accessories



SC-JB8

8 mm 0.315 in spacing



1SNK160231F0014

SC-JB8 short circuit bridges

Description

- Allow safe short-circuiting of current Transformers circuits,
- Insulated,
- Fully operated by screwdriver,
- Short circuited fixed position secured thanks to AJS9 tightening,
- Adapted hook shape maintains the bridge on the terminal block in the non short-circuited position,
- The orange version can be used as fixed jumpers.

Ordering details

Description		Color	Type	Part Number	Pkg qty	Weight (1 pce) g
8 mm 0.315 in spacing	2 poles	Yellow 	SC-JB8-2	1SNK900652R0000	25	2.00
	3 poles		SC-JB8-3	1SNK900653R0000	25	3.4
	4 poles		SC-JB8-4	1SNK900654R0000	25	4.7
	3/5 poles		SC-JB8-5	1SNK900655R0000	25	4.7
	3 poles		Orange 	SC-JB8-3-OR	1SNK900657R0000	25
	4 poles	SC-JB8-4-OR		1SNK900658R0000	25	

Main technical data

Material specifications	Insulating material	Polyamide	
	Flammability	V0	
	NF F 16 101	I2F3	
Ambient temperature min/max	Service IEC 60068-2-1	-55 ... +110 °C	-67 ... +230 °F
	Storage	-55 ... +110 °C	-67 ... +230 °F
	Installing	-5 ... +40 °C	+23 ... +104 °F

All the main technical data provided are "manufacturer" values

	RoHS																		
	RoHS																		

Technical data valid for copper conductors only.

Test sockets

Screw clamp terminal block accessories



AJS

4 mm 0.157 in spacing

AJS test sockets

Description

- Insulated test sockets,
 - Many colors available for circuit identification,
 - Compatible with standard DIA 4 mm 0.157 in test plugs:
 - insulated (according to IEC 60101-031) - not insulated (with mobile protection),
 - Compatible with ZS10-ST...SNK series terminal blocks, M6/8.ST...SNA series terminal blocks, D6/8.ST.RS..Solution series terminal blocks



Ordering details

Description	Color	Type	Part Number	Pkg qty	Weight (1 pce) g
Test sockets DIA 4 mm 0.157 in	Grey <input type="checkbox"/>	AJS9-GR	1SNA206682R0300	25	3.60
	Blue <input type="checkbox"/>	AJS9-BL	1SNA206683R0400	25	3.60
	Yellow <input type="checkbox"/>	AJS9	1SNA179726R0200	25	3.60
	Green <input type="checkbox"/>	AJS9-GN	1SNA206681R0200	25	3.60
	Red <input type="checkbox"/>	AJS9-RD	1SNA206720R1400	25	3.60
	Purple <input type="checkbox"/>	AJS9-PR	1SNA206772R0000	25	3.60
	Brown <input type="checkbox"/>	AJS9-BR	1SNA206782R0000	25	3.60
	White <input type="checkbox"/>	AJS9-WH	1SNA206765R0000	25	3.60
	Black <input type="checkbox"/>	AJS9-BK	1SNA206680R1500	25	3.60

Main technical data

Material specifications	Insulating material	Polyamide	
	Flammability	V0	
	NF F 16 101	I2F3	
Ambient temperature min/max	Service IEC 60068-2-1	-55 ... +110 °C	-67 ... +230 °F
	Storage	-55 ... +110 °C	-67 ... +230 °F
	Installing	-5 ... +40 °C	+23 ... +104 °F

Mounting instructions

Tool		Flat screwdriver Ø 3.5 mm Ø 0.138 in
Torque		0.5 Nm ± 0.1 4.42 lb.in ± 0.88

All the main technical data provided are "manufacturer" values

RoHS	<input type="checkbox"/>								
RoHS	<input type="checkbox"/>								

Technical data valid for copper conductors only.

End sections

Pluggable terminal block accessories



EDK2.5-22

1SNK805910R0000

EDK2.5-22 end sections

Description

– Compatible with ZDK2.5-22 and ZDK4-22 pluggable terminal blocks.

Description	Color	Type	Part Number	Pkg qty	Weight 1 pce g
2.2 mm 0.087 in spacing	Dark grey	■ EDK2.5-22	1SNK805910R0000	20	3.08



EDK2.5-21

1SNK805914R0000

EDK2.5-21 end sections

Description

– Compatible with ZDK2.5-11, ZDK2.5-11-BL and ZDK2.5-11-PE pluggable terminal blocks.

Description	Color	Type	Part Number	Pkg qty	Weight 1 pce g
1.5 mm 0.059 in spacing	Dark grey	■ EDK2.5-21	1SNK805914R0000	20	1.90



EDK2.5-11

1SNK805915R0000

EDK2.5-11 end sections

Description

– Compatible with ZDK2.5-11 pluggable terminal blocks.

Description	Color	Type	Part Number	Pkg qty	Weight 1 pce g
1.5 mm 0.059 in spacing	Dark grey	■ EDK2.5-11	1SNK805915R0000	20	1.49



EDK2.5-D

1SNK805913R0000

EDK2.5-D end sections

Description

– Compatible with ZDK2.5-D2, ZDK2.5-D2-BL, ZDK2.5-D1, ZDK2.5-D1-PE and ZDK2.5-D2-PE pluggable terminal blocks.

Description	Color	Type	Part Number	Pkg qty	Weight 1 pce g
2 mm 0.079 in spacing	Dark grey	■ EDK2.5-D	1SNK805913R0000	20	3.88

Main technical data

Material specifications	Insulating material	Polyamide	
	Flammability	V0	
	NF F 16 101	I2F2	
Ambient temperature min/max	Service IEC 60068-2-1	-55 ... +110 °C	-67 ... +230 °C
	Storage	-55 ... +110 °C	-67 ... +230 °C
	Installing	-5 ... +40 °C	+23 ... +104 °C

All the main technical data provided are "manufacturer" values.

RoHS

Technical data valid for copper conductors only.

End sections

Pluggable terminal block accessories



1SNK164028W0014

ED2.5-22 end sections

Description

– Compatible with ZD2.5-22 and ZD2.5-22-PE pluggable terminal blocks.

Ordering details

Description	Color	Type	Part Number	Pkg qty	Weight (1 pce) g
2 mm 0.079 in spacing	Dark grey	ED2.5-22	1SNK805917R0000	20	3.64

ED2.5-22



1SNK164032W0014

EDS4-22 end sections

Description

– Compatible with ZDS4-22 pluggable terminal block.

Ordering details

Description	Color	Type	Part Number	Pkg qty	Weight (1 pce) g
0.8 mm 0.031 in spacing	Dark grey	EDS4-22	1SNK805911R0000	20	1.85

EDS4-22

Main technical data

Material specifications	Insulating material	Polyamide	
	Flammability	V0	
	NF F 16 101	I2F2	
Ambient temperature min/max	Service IEC 60068-2-1	-55 ... +110 °C	-67 ... +230 °C
	Storage	-55 ... +110 °C	-67 ... +230 °C
	Installing	-5 ... +40 °C	+23 ... +104 °C

All the main technical data provided are "manufacturer" values.

RoHS																			
RoHS																			

Technical data valid for copper conductors only.

1SNK164034S0201

Coding pegs - Locking devices

Pluggable terminal block accessories



COP

COP coding pegs

Description

– The coding pegs prevent plugs to be inserted into the wrong circuit.

Ordering details

Description	Color	Type	Part Number	Pkg qty	Weight (1 pce) g
	Dark grey ■	COP-ZD	1SNK900636R0000	10	3.57

Main technical data

Material specifications	Insulating material	Polyamide	
	Flammability	V0	
	NF F 16 101	I2F2	
Ambient temperature min/max	Service IEC 60068-2-1	-55 ... +110 °C	-67 ... +230 °F
	Storage	-55 ... +110 °C	-67 ... +230 °F
	Installing	-5 ... +40 °C	+23 ... +104 °F

All the main technical data provided are "manufacturer" values.

RoHS	RoHS								
------	------	--	--	--	--	--	--	--	--

Mounting instructions

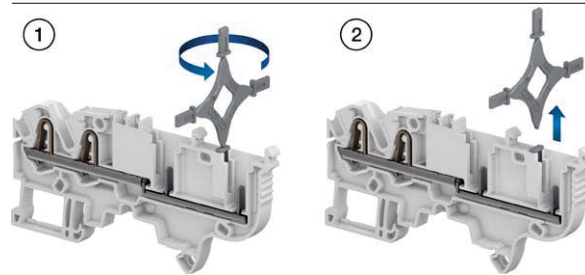

VR

9.4 mm 0.370 in spacing

VR locking devices

Description

- Automatic locking providing excellent plug withstand in case of accidental pulling,
- Lock safely one or two CDK or CDS plugs on ZDK and ZDS pluggable terminal blocks,
- Install one VR... up to 8 poles plugs assembly and two VR... up to 15 poles assembly.

Ordering details

Description	Color	Type	Part Number	Pkg qty	Weight (1 pce) g
9.4 mm 0.370 in spacing	Black ■	VR-ZD	1SNK900637R0000	50	6.5

Main technical data

Material specifications	Insulating material	Polyacetal	
	Flammability	HB	
	NF F 16 101		
Ambient temperature min/max	Service IEC 60068-2-1	-55 ... +110 °C	-67 ... +230 °F
	Storage	-55 ... +110 °C	-67 ... +230 °F
	Installing	-5 ... +40 °C	+23 ... +104 °F

All the main technical data provided are "manufacturer" values.

RoHS	RoHS								
------	------	--	--	--	--	--	--	--	--

Mounting instructions

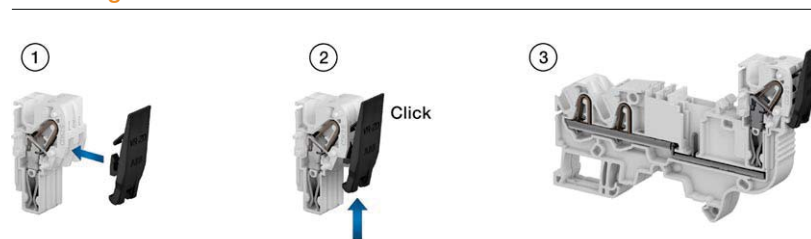

Technical data valid for copper conductors only.



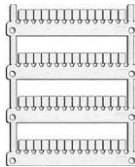

Selection guide	238-239
MG3 thermal transfer printer	240-241
AMS 600 and AMS 250 plotter	242-243

Terminal block markers

5.2 mm 0.205 in spacing

MC512, MG-CPM-13	Blank card in polycarbonate	244
MC512PA	Blank card in polyamide	245
	Pre-printed marker card for horizontal terminal block assembly	246-247
	Pre-printed marker card for vertical terminal block assembly	248-249

6 mm 0.236 in spacing

MC612, MG-CPM-13	Blank card in polycarbonate	250
MC612PA	Blank card in polyamide	251
	Pre-printed marker card for horizontal terminal block assembly	252-253
	Pre-printed marker card for vertical terminal block assembly	254

8 mm 0.315 in spacing

MC812, MC812PA	Blank card	256
MC812PA	Pre-printed marker card for horizontal terminal block assembly	257-258
	Pre-printed marker card for vertical terminal block assembly	259-260

Markers

UMH	Universal wire markers holder	261
MG2-TDMO	Clip-on blank wire marker	261
MG-TAR, MG-TAA	Markers for components	262
MG-TAPW	Markers for components	263
MCLH	Label	264

Marking systems

HTP500	Consumable	265
MG3	Thermal transfer printer	266
AMS	Plotter	267-268

For versatile applications



Marking systems	MG3
Technology	Thermal transfer
Printing mode	Manual
Printing speed	Medium
Printing quality	300 x 600 dpi
1 ribbon or ink cartridge printing capacity	~ 160 000, MG-CPM (5 x 10 mm markers)
Printing color available (monochrome)	Black / Red / Blue / Green / White
Terminal block markers material	Polycarbonate
Terminal block markers	
SNK series terminal blocks blank markers polyamide	–
SNK series terminal blocks blank markers polycarbonate	MG-CPM
SNK series terminal blocks blank markers PVC	MG-CPMF
End stop markers	2 marker types
Other terminal blocks manufacturers blank markers	15 manufacturers
Wires and cables markers	4 marker types
Components and equipment markers	9 marker types

For basic marking applications



AMS 600 - AMS 250

Plotter

Manual

Low

300 x 300 dpi

~ 230 000 markers (with 3 characters per markers)

Black

Polyamide

MC...PA

-

-

4 marker types

5 manufacturers

1 marker type

9 marker types



The versatile, compact and robust marking system

MARKINGGenius® MG3 is a high resolution printer based on thermal transfer technology for producing high quality identification and labelling for terminal blocks, cables and all equipment mounted in electrical panels.

Compact, ergonomic, clean and quiet, MARKINGGenius® MG3 may be conveniently located in an office or workshop or easily transported in the field.

Thermal transfer technology uses heat to transfer characters or symbols onto a plastic marker through an ink ribbon.

Besides the excellent printing quality, there is no drying time and the markers are instantly usable.

With the MG3 thermal transfer printer, forget about drying times and clogged print head problems.

Combined simplicity, performance and make savings

Facilitate your printing process

Compact design (382 x 230 x 230 mm) facilitates use in workshops or in the field.

Easy to install and use: comprehensive quick-start kit. Intuitive software with easy data import and entry.

Versatile: many different media available: plastic markers, stickers, labels etc.

Save time and consumables

Gain time with a short printing process:

12 seconds cycle. Carriage loading and unloading operation is fast and simple.

Economic: up to 300 000 markers with one ribbon. Partially printed marker card may be reused to avoid wastage.

No drying time: printed markers are immediately ready to use.

Experience quality

High Quality printing: 300 x 600 dpi for image or graphic printing.

Robust: all moving parts are in metal.



High quality printing



Short printing cycle of 12 seconds



Economic: up to 300 000 markers with one ribbon



Many media types available for printing

MG3 thermal transfer printer

Components of the kit

The MG3 printer is delivered with a comprehensive set of accessories for getting started quickly

Kit (Part number: 1SNB419001R0000) including:

- 1 Thermal transfer printer
- 1 Software CD
- 1 Power supply cable
- 1 USB cable
- 1 Installation, operating, maintenance and user documentation
- 1 Protective cover
- 1 Ribbon take up spool
- 1 MG2-QTB support plate for terminal block markers (MG-CPM-01, 02, 03, 04, 07)
- 1 MG2-PWC support plate for wire and cable markers (MG-TPM)
- 1 MG2-PLT support plate for wire and cable markers (MG-TPMF) and various labels and signs
- 1 MG2-ETB Support plate for SNK series terminal block markers (MG-CPM-13)
- 1 MG2-ETR Black printing ribbon.

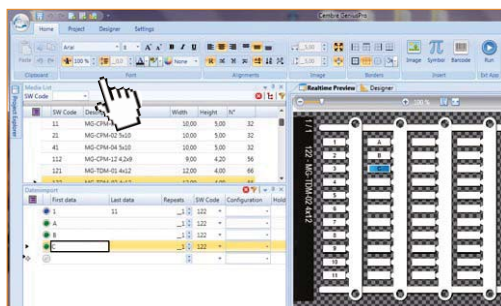

Genius Pro software

The Genius Pro software application benefits from long experience in the field and requires the operator to have only basic skills in order to use it. It is application-oriented and provides fast and easy data entry including a dynamic full-size media preview giving an accurate representation of the current job.

Features / characteristics:

- More than ten types of counter such as *.txt, *.cad, *.dbf, *.xls can be imported
- AutoCAD, Elcad, Spac and Excel import
- MATRIX, ACS and Simplo conversion

- Optimised printing of media for cables, terminal blocks, control gear, connectors, push buttons, components, panels and self-adhesive labels
- Specially developed proprietary Genius font and also Windows fonts
- Designs customised media
- Vector, drawing and clip art printing
- Free upgrades for each new release
- Microsoft® Windows® XP, Windows Vista®, Windows 2000 SP4®, Windows 7®.

AMS 600 and AMS 250 plotter

The universal standard for printing jobs



AMS 600

Universal printing plotter

Compatible with all original manufacturer terminal block markers (polyamide), it can also print other identification supports such as: wire and cable markers, push buttons, panels... This plotter offers a large working area, hosting up to 4 different support plates for one plot job.

Error detection mode

The A3 panel automatically recognises the support plate and avoids the need to select marking elements, it also warns the user when the support is wrongly installed.

Dry out protection system

Pens are prevented from drying out thanks to AMS 600 integrated pen station.



AMS 250

Compact

This A4 plotter is smaller than AMS 600 and is more suited to a cluttered environment.

Automatic installation

The installation program starts automatically. The computer just needs to be rebooted after it has finished and printing can start.

What you see is what you get !

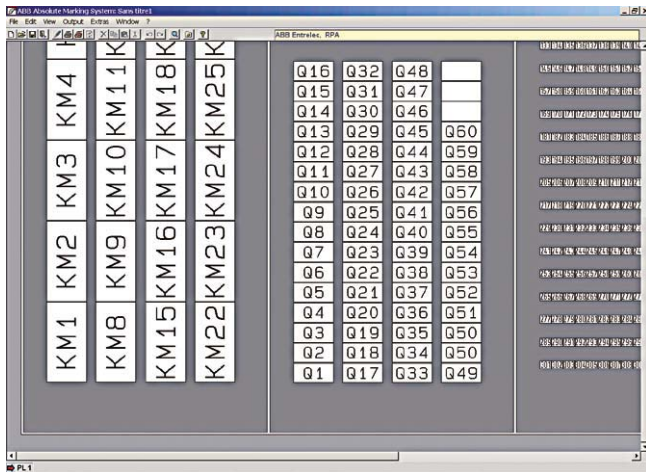

User friendly
Microsoft® Windows® software

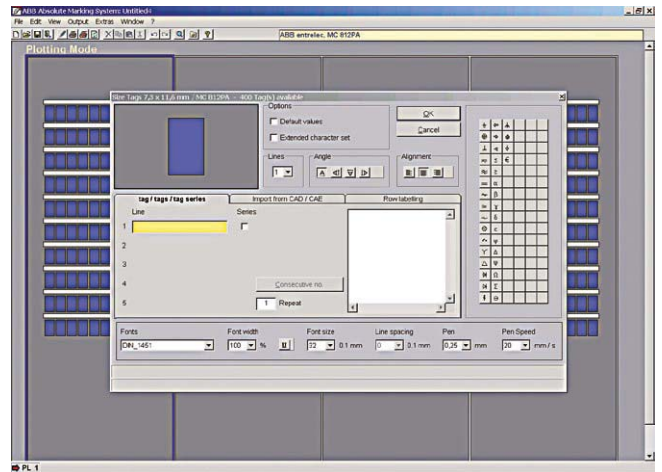

Time saving: data import function
from CAD, TXT and Excel® files



New special ink disposable plotter pens ED-R

- Disposable pens ED-R almost never clog, they are ideal for use in particularly dry environments.
- These pens are filled with the permanent ink ED, most suitable for marking various plastic surfaces.
- The ED ink should only be used on plastic material. Do not clean or touch with aggressive fluids.
- For applications outside of the control panel the ink P 2.0 is more suitable and durable.

Terminal block markers

Blank card in polycarbonate - 5.2 mm 0.205 in spacing



MC512

MC512 terminal block markers

Description

- MC512 marker card in polycarbonate for high marking quality, durability and speed when marked with the HTP500 printer,
- Excellent marking durability in the most severe environments,
- Improved marking visibility thanks to the increased marking surface +20% (12 mm 0.472 in).

Main technical data

Material	Flammability	Maximum printed digits				Dimensions	
		Horizontal		Vertical		mm	inches
Polycarbonate	V0	3	8	4.8	12	0.189	0.472

Ordering details

Description	Number of markers per card	Color	Type	Part Number	Pkg card	Weight (1 pce) g
Blank card	45	White <input type="checkbox"/>	MC512	1SNK140000R0000	22	9.00
		Yellow <input checked="" type="checkbox"/>	MC512-YL	1SNK140004R0000	22	9.00



HTP500-V2

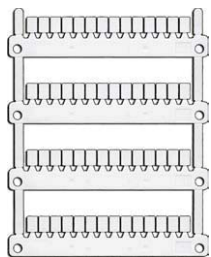

MG-CPM-13

MG-CPM-13 terminal block markers

Description

- MG-CPM-13 41790 and 41740 markers are used for marking 5.2 mm 0.205 in spacing SNK terminal blocks,
- Provide an elevate mechanical robustness, high dimensional stability and are halogen free,
- Single application on terminal block,
- 35 cards per packing

Main technical data

Material	Flammability	Maximum printed digits				Dimensions	
		Horizontal		Vertical		mm	inches
Polycarbonate	V2	3	8	4.8	12	0.196	0.472

Ordering details

Description	Number of markers per card	Color	Type	Part Number	Pkg marker	Weight (1 pce) g
Blank card	56	White <input type="checkbox"/>	MG-CPM 13 41790	1SNB041790R0512	1960	0.232
		Yellow <input checked="" type="checkbox"/>	MG-CPM 13 41740	1SNB041740R0512	1960	0.232

Marking systems

Description	Type	Part Number	Pkg qty	Weight (1 pce) g
Thermal transfer printer	MG3 KIT	1SNB419001R0000	1	12600.00

Marking systems accessories

Description	Type	Part Number	Pkg qty	Weight (1 pce) g
Support plate for MG-CPM-13	MG2-ETB 991016	1SNB991016R0000	1	100.00



MG3 KIT

Terminal block markers

Blank card in polyamide - 5.2 mm 0.205 in spacing



MC512PA



AMS 600

MC512PA terminal block markers

Description

- MC512PA marker card in polyamide to be marked on AMS 600 marking table for medium scale volumes and standard industrial applications,
- Terminal blocks are directly independent after strip mounting,
- Improved marking visibility thanks to the increased marking surface +20% (12 mm 0.472 in).

Main technical data

Material	Flammability	Maximum printed digits		Dimensions	
		Horizontal	Vertical	mm	inches
Polyamide	V2	3	8	4.8 x 12	0.189 x 0.472

Ordering details

Description	Number of markers per card	Color	Type	Part Number	Pkg card	Weight (1 pce) g
Blank card	100	White <input type="checkbox"/>	MC512PA	1SNK149999R0000	20	10.00

Marking systems

Description	Type	Part Number	Pkg qty	Weight (1 pce) g
AMS plotter	AMS 600 KIT	1SNA360000R2400	1	12600.00

Marking systems accessories

Description	Type	Part Number	Pkg qty	Weight (1 pce) g
Marking support plate for MC PA marker cards (3 MC PA marker cards per plate)	SPRC 30-3	1SNA360039R1700	1	300.00

MC512PA terminal block markers

Pre-printed marker card for horizontal terminal block assembly



MC512PA



5.2 mm 0.205 in spacing

Description

Save printing time with our large pre-printed cards offer with pre-printed numbers, letters or symbols.

Main technical data

Material	Flammability	Dimensions	
		mm	inches
Polyamide	V2	4.8 x 12	0.189 x 0.472

Ordering details

Description	Number of markers per card	Color	Type	Part Number	Pkg card	Weight (1 pce) g
0->9 (x10)	100	White <input type="checkbox"/>	MC512PA	1SNK140091R0000	1	10.00
1->10 (x10)	100	White <input type="checkbox"/>	MC512PA	1SNK140011R0000	1	10.00
11->20 (x10)	100	White <input type="checkbox"/>	MC512PA	1SNK140021R0000	1	10.00
21->30 (x10)	100	White <input type="checkbox"/>	MC512PA	1SNK140031R0000	1	10.00
31->40 (x10)	100	White <input type="checkbox"/>	MC512PA	1SNK140041R0000	1	10.00
41->50 (x10)	100	White <input type="checkbox"/>	MC512PA	1SNK140051R0000	1	10.00
51->60 (x10)	100	White <input type="checkbox"/>	MC512PA	1SNK140061R0000	1	10.00
61->70 (x10)	100	White <input type="checkbox"/>	MC512PA	1SNK140071R0000	1	10.00
71->80 (x10)	100	White <input type="checkbox"/>	MC512PA	1SNK140081R0000	1	10.00
81->90 (x10)	100	White <input type="checkbox"/>	MC512PA	1SNK140083R0000	1	10.00
91->100 (x10)	100	White <input type="checkbox"/>	MC512PA	1SNK140101R0000	1	10.00
101->110 (x10)	100	White <input type="checkbox"/>	MC512PA	1SNK140111R0000	1	10.00
111->120 (x10)	100	White <input type="checkbox"/>	MC512PA	1SNK140121R0000	1	10.00
121->130 (x10)	100	White <input type="checkbox"/>	MC512PA	1SNK140131R0000	1	10.00
131->140 (x10)	100	White <input type="checkbox"/>	MC512PA	1SNK140141R0000	1	10.00
141->150 (x10)	100	White <input type="checkbox"/>	MC512PA	1SNK140151R0000	1	10.00
151->160 (x10)	100	White <input type="checkbox"/>	MC512PA	1SNK140161R0000	1	10.00
161->170 (x10)	100	White <input type="checkbox"/>	MC512PA	1SNK140171R0000	1	10.00
171->180 (x10)	100	White <input type="checkbox"/>	MC512PA	1SNK140181R0000	1	10.00
181->190 (x10)	100	White <input type="checkbox"/>	MC512PA	1SNK140191R0000	1	10.00
191->200 (x10)	100	White <input type="checkbox"/>	MC512PA	1SNK140201R0000	1	10.00
1->100	100	White <input type="checkbox"/>	MC512PA	1SNK145011R0000	1	10.00
101->200	100	White <input type="checkbox"/>	MC512PA	1SNK145021R0000	1	10.00
201->300	100	White <input type="checkbox"/>	MC512PA	1SNK145031R0000	1	10.00
301->400	100	White <input type="checkbox"/>	MC512PA	1SNK145041R0000	1	10.00
401->500	100	White <input type="checkbox"/>	MC512PA	1SNK145051R0000	1	10.00
501->600	100	White <input type="checkbox"/>	MC512PA	1SNK145061R0000	1	10.00
601->700	100	White <input type="checkbox"/>	MC512PA	1SNK145071R0000	1	10.00
701->800	100	White <input type="checkbox"/>	MC512PA	1SNK145081R0000	1	10.00
801->900	100	White <input type="checkbox"/>	MC512PA	1SNK145091R0000	1	10.00
A (x100)	100	White <input type="checkbox"/>	MC512PA	1SNK146011R0000	1	10.00
B (x100)	100	White <input type="checkbox"/>	MC512PA	1SNK146021R0000	1	10.00
C (x100)	100	White <input type="checkbox"/>	MC512PA	1SNK146031R0000	1	10.00
D (x100)	100	White <input type="checkbox"/>	MC512PA	1SNK146041R0000	1	10.00
E (x100)	100	White <input type="checkbox"/>	MC512PA	1SNK146051R0000	1	10.00
F (x100)	100	White <input type="checkbox"/>	MC512PA	1SNK146061R0000	1	10.00
G (x100)	100	White <input type="checkbox"/>	MC512PA	1SNK146071R0000	1	10.00
H (x100)	100	White <input type="checkbox"/>	MC512PA	1SNK146081R0000	1	10.00
I (x100)	100	White <input type="checkbox"/>	MC512PA	1SNK146091R0000	1	10.00
J (x100)	100	White <input type="checkbox"/>	MC512PA	1SNK146101R0000	1	10.00
K (x100)	100	White <input type="checkbox"/>	MC512PA	1SNK146111R0000	1	10.00
L (x100)	100	White <input type="checkbox"/>	MC512PA	1SNK146121R0000	1	10.00
M (x100)	100	White <input type="checkbox"/>	MC512PA	1SNK146131R0000	1	10.00
N (x100)	100	White <input type="checkbox"/>	MC512PA	1SNK146141R0000	1	10.00
O (x100)	100	White <input type="checkbox"/>	MC512PA	1SNK146151R0000	1	10.00
P (x100)	100	White <input type="checkbox"/>	MC512PA	1SNK146161R0000	1	10.00
Q (x100)	100	White <input type="checkbox"/>	MC512PA	1SNK146171R0000	1	10.00
R (x100)	100	White <input type="checkbox"/>	MC512PA	1SNK146181R0000	1	10.00
S (x100)	100	White <input type="checkbox"/>	MC512PA	1SNK146191R0000	1	10.00
T (x100)	100	White <input type="checkbox"/>	MC512PA	1SNK146201R0000	1	10.00
U (x100)	100	White <input type="checkbox"/>	MC512PA	1SNK146211R0000	1	10.00
V (x100)	100	White <input type="checkbox"/>	MC512PA	1SNK146221R0000	1	10.00
W (x100)	100	White <input type="checkbox"/>	MC512PA	1SNK146231R0000	1	10.00
X (x100)	100	White <input type="checkbox"/>	MC512PA	1SNK146241R0000	1	10.00
Y (x100)	100	White <input type="checkbox"/>	MC512PA	1SNK146251R0000	1	10.00

Continue on next page →

1SNK160004S0201 - Rev. A

MC512PA terminal block markers

Pre-printed marker card for horizontal terminal block assembly



MC512PA



5.2 mm 0.205 in spacing

Ordering details

Description	Number of markers per card	Color	Type	Part Number	Pkg card	Weight (1 pce) g
← Continuation of previous page						
Z (x100)	100	White <input type="checkbox"/>	MC512PA	1SNK146261R0000	1	10.00
0 (x100)	100	White <input type="checkbox"/>	MC512PA	1SNK147001R0000	1	10.00
1 (x100)	100	White <input type="checkbox"/>	MC512PA	1SNK147011R0000	1	10.00
2 (x100)	100	White <input type="checkbox"/>	MC512PA	1SNK147021R0000	1	10.00
3 (x100)	100	White <input type="checkbox"/>	MC512PA	1SNK147031R0000	1	10.00
4 (x100)	100	White <input type="checkbox"/>	MC512PA	1SNK147041R0000	1	10.00
5 (x100)	100	White <input type="checkbox"/>	MC512PA	1SNK147051R0000	1	10.00
6 (x100)	100	White <input type="checkbox"/>	MC512PA	1SNK147061R0000	1	10.00
7 (x100)	100	White <input type="checkbox"/>	MC512PA	1SNK147071R0000	1	10.00
8 (x100)	100	White <input type="checkbox"/>	MC512PA	1SNK147081R0000	1	10.00
9 (x100)	100	White <input type="checkbox"/>	MC512PA	1SNK147091R0000	1	10.00
+ (x100)	100	White <input type="checkbox"/>	MC512PA	1SNK148001R0000	1	10.00
- (x100)	100	White <input type="checkbox"/>	MC512PA	1SNK148011R0000	1	10.00
~ (x100)	100	White <input type="checkbox"/>	MC512PA	1SNK148021R0000	1	10.00
= (x100)	100	White <input type="checkbox"/>	MC512PA	1SNK148031R0000	1	10.00
≠ (x100)	100	White <input type="checkbox"/>	MC512PA	1SNK148041R0000	1	10.00
L1 (x100)	100	White <input type="checkbox"/>	MC512PA	1SNK148051R0000	1	10.00
L2 (x100)	100	White <input type="checkbox"/>	MC512PA	1SNK148061R0000	1	10.00
L3 (x100)	100	White <input type="checkbox"/>	MC512PA	1SNK148071R0000	1	10.00
PE (x100)	100	White <input type="checkbox"/>	MC512PA	1SNK148091R0000	1	10.00
U1 (x100)	100	White <input type="checkbox"/>	MC512PA	1SNK148101R0000	1	10.00
U2 (x100)	100	White <input type="checkbox"/>	MC512PA	1SNK148111R0000	1	10.00
U3 (x100)	100	White <input type="checkbox"/>	MC512PA	1SNK148121R0000	1	10.00
V1 (x100)	100	White <input type="checkbox"/>	MC512PA	1SNK148131R0000	1	10.00
V2 (x100)	100	White <input type="checkbox"/>	MC512PA	1SNK148141R0000	1	10.00
V3 (x100)	100	White <input type="checkbox"/>	MC512PA	1SNK148151R0000	1	10.00
W1 (x100)	100	White <input type="checkbox"/>	MC512PA	1SNK148161R0000	1	10.00
W2 (x100)	100	White <input type="checkbox"/>	MC512PA	1SNK148171R0000	1	10.00
W3 (x100)	100	White <input type="checkbox"/>	MC512PA	1SNK148181R0000	1	10.00
L1-L2-L3-N-PE (x20)	100	White <input type="checkbox"/>	MC512PA	1SNK149001R0000	1	10.00
U1-U2-U3-V1-V2-V3-W1-W2-W3 (x10) + U1 (x10)	100	White <input type="checkbox"/>	MC512PA	1SNK149011R0000	1	10.00

MC512PA terminal block markers

Pre-printed marker card for vertical terminal block assembly



MC512PA



5.2 mm 0.205 in spacing

Description

Save printing time with our large pre-printed cards offer with pre-printed numbers, letters or symbols.

Main technical data

Material	Flammability	Dimensions	
		mm	inches
Polyamide	V2	4.8 x 12	0.189 x 0.472

Ordering details

Description	Number of markers per card	Color	Type	Part Number	Pkg card	Weight (1 pce) g
0->9 (x10)	100	White <input type="checkbox"/>	MC512PA	1SNK140092R0000	1	10.00
1->10 (x10)	100	White <input type="checkbox"/>	MC512PA	1SNK140012R0000	1	10.00
11->20 (x10)	100	White <input type="checkbox"/>	MC512PA	1SNK140022R0000	1	10.00
21->30 (x10)	100	White <input type="checkbox"/>	MC512PA	1SNK140032R0000	1	10.00
31->40 (x10)	100	White <input type="checkbox"/>	MC512PA	1SNK140042R0000	1	10.00
41->50 (x10)	100	White <input type="checkbox"/>	MC512PA	1SNK140052R0000	1	10.00
51->60 (x10)	100	White <input type="checkbox"/>	MC512PA	1SNK140062R0000	1	10.00
61->70 (x10)	100	White <input type="checkbox"/>	MC512PA	1SNK140072R0000	1	10.00
71->80 (x10)	100	White <input type="checkbox"/>	MC512PA	1SNK140082R0000	1	10.00
81->90 (x10)	100	White <input type="checkbox"/>	MC512PA	1SNK140084R0000	1	10.00
91->100 (x10)	100	White <input type="checkbox"/>	MC512PA	1SNK140102R0000	1	10.00
101->110 (x10)	100	White <input type="checkbox"/>	MC512PA	1SNK140112R0000	1	10.00
111->120 (x10)	100	White <input type="checkbox"/>	MC512PA	1SNK140122R0000	1	10.00
121->130 (x10)	100	White <input type="checkbox"/>	MC512PA	1SNK140132R0000	1	10.00
131->140 (x10)	100	White <input type="checkbox"/>	MC512PA	1SNK140142R0000	1	10.00
141->150 (x10)	100	White <input type="checkbox"/>	MC512PA	1SNK140152R0000	1	10.00
151->160 (x10)	100	White <input type="checkbox"/>	MC512PA	1SNK140162R0000	1	10.00
161->170 (x10)	100	White <input type="checkbox"/>	MC512PA	1SNK140172R0000	1	10.00
171->180 (x10)	100	White <input type="checkbox"/>	MC512PA	1SNK140182R0000	1	10.00
181->190 (x10)	100	White <input type="checkbox"/>	MC512PA	1SNK140192R0000	1	10.00
191->200 (x10)	100	White <input type="checkbox"/>	MC512PA	1SNK140202R0000	1	10.00
1->100	100	White <input type="checkbox"/>	MC512PA	1SNK145012R0000	1	10.00
101->200	100	White <input type="checkbox"/>	MC512PA	1SNK145022R0000	1	10.00
201->300	100	White <input type="checkbox"/>	MC512PA	1SNK145032R0000	1	10.00
301->400	100	White <input type="checkbox"/>	MC512PA	1SNK145042R0000	1	10.00
401->500	100	White <input type="checkbox"/>	MC512PA	1SNK145052R0000	1	10.00
501->600	100	White <input type="checkbox"/>	MC512PA	1SNK145062R0000	1	10.00
601->700	100	White <input type="checkbox"/>	MC512PA	1SNK145072R0000	1	10.00
701->800	100	White <input type="checkbox"/>	MC512PA	1SNK145082R0000	1	10.00
801->900	100	White <input type="checkbox"/>	MC512PA	1SNK145092R0000	1	10.00
901->1000	100	White <input type="checkbox"/>	MC512PA	1SNK145102R0000	1	10.00
A (x100)	100	White <input type="checkbox"/>	MC512PA	1SNK146012R0000	1	10.00
B (x100)	100	White <input type="checkbox"/>	MC512PA	1SNK146022R0000	1	10.00
C (x100)	100	White <input type="checkbox"/>	MC512PA	1SNK146032R0000	1	10.00
D (x100)	100	White <input type="checkbox"/>	MC512PA	1SNK146042R0000	1	10.00
E (x100)	100	White <input type="checkbox"/>	MC512PA	1SNK146052R0000	1	10.00
F (x100)	100	White <input type="checkbox"/>	MC512PA	1SNK146062R0000	1	10.00
G (x100)	100	White <input type="checkbox"/>	MC512PA	1SNK146072R0000	1	10.00
H (x100)	100	White <input type="checkbox"/>	MC512PA	1SNK146082R0000	1	10.00
I (x100)	100	White <input type="checkbox"/>	MC512PA	1SNK146092R0000	1	10.00
J (x100)	100	White <input type="checkbox"/>	MC512PA	1SNK146102R0000	1	10.00
K (x100)	100	White <input type="checkbox"/>	MC512PA	1SNK146112R0000	1	10.00
L (x100)	100	White <input type="checkbox"/>	MC512PA	1SNK146122R0000	1	10.00
M (x100)	100	White <input type="checkbox"/>	MC512PA	1SNK146132R0000	1	10.00
N (x100)	100	White <input type="checkbox"/>	MC512PA	1SNK146142R0000	1	10.00
O (x100)	100	White <input type="checkbox"/>	MC512PA	1SNK146152R0000	1	10.00
P (x100)	100	White <input type="checkbox"/>	MC512PA	1SNK146162R0000	1	10.00
Q (x100)	100	White <input type="checkbox"/>	MC512PA	1SNK146172R0000	1	10.00
R (x100)	100	White <input type="checkbox"/>	MC512PA	1SNK146182R0000	1	10.00
S (x100)	100	White <input type="checkbox"/>	MC512PA	1SNK146192R0000	1	10.00
T (x100)	100	White <input type="checkbox"/>	MC512PA	1SNK146202R0000	1	10.00
U (x100)	100	White <input type="checkbox"/>	MC512PA	1SNK146212R0000	1	10.00
V (x100)	100	White <input type="checkbox"/>	MC512PA	1SNK146222R0000	1	10.00

Continue on next page →

1SNK16005S0201 - Rev. A

MC512PA terminal block markers

Pre-printed marker card for vertical terminal block assembly



MC512PA



5.2 mm 0.205 in spacing

Ordering details

Description	Number of markers per card	Color	Type	Part Number	Pkg card	Weight (1 pce) g
← Continuation of previous page						
W (x100)	100	White <input type="checkbox"/>	MC512PA	1SNK146232R0000	1	10.00
X (x100)	100	White <input type="checkbox"/>	MC512PA	1SNK146242R0000	1	10.00
Y (x100)	100	White <input type="checkbox"/>	MC512PA	1SNK146252R0000	1	10.00
Z (x100)	100	White <input type="checkbox"/>	MC512PA	1SNK146262R0000	1	10.00
0 (x100)	100	White <input type="checkbox"/>	MC512PA	1SNK147002R0000	1	10.00
1 (x100)	100	White <input type="checkbox"/>	MC512PA	1SNK147012R0000	1	10.00
2 (x100)	100	White <input type="checkbox"/>	MC512PA	1SNK147022R0000	1	10.00
3 (x100)	100	White <input type="checkbox"/>	MC512PA	1SNK147032R0000	1	10.00
4 (x100)	100	White <input type="checkbox"/>	MC512PA	1SNK147042R0000	1	10.00
5 (x100)	100	White <input type="checkbox"/>	MC512PA	1SNK147052R0000	1	10.00
6 (x100)	100	White <input type="checkbox"/>	MC512PA	1SNK147062R0000	1	10.00
7 (x100)	100	White <input type="checkbox"/>	MC512PA	1SNK147072R0000	1	10.00
8 (x100)	100	White <input type="checkbox"/>	MC512PA	1SNK147082R0000	1	10.00
9 (x100)	100	White <input type="checkbox"/>	MC512PA	1SNK147092R0000	1	10.00
+ (x100)	100	White <input type="checkbox"/>	MC512PA	1SNK148002R0000	1	10.00
- (x100)	100	White <input type="checkbox"/>	MC512PA	1SNK148012R0000	1	10.00
~ (x100)	100	White <input type="checkbox"/>	MC512PA	1SNK148022R0000	1	10.00
= (x100)	100	White <input type="checkbox"/>	MC512PA	1SNK148032R0000	1	10.00
± (x100)	100	White <input type="checkbox"/>	MC512PA	1SNK148042R0000	1	10.00
L1 (x100)	100	White <input type="checkbox"/>	MC512PA	1SNK148052R0000	1	10.00
L2 (x100)	100	White <input type="checkbox"/>	MC512PA	1SNK148062R0000	1	10.00
L3 (x100)	100	White <input type="checkbox"/>	MC512PA	1SNK148072R0000	1	10.00
PE (x100)	100	White <input type="checkbox"/>	MC512PA	1SNK148092R0000	1	10.00
U1 (x100)	100	White <input type="checkbox"/>	MC512PA	1SNK148102R0000	1	10.00
U2 (x100)	100	White <input type="checkbox"/>	MC512PA	1SNK148112R0000	1	10.00
U3 (x100)	100	White <input type="checkbox"/>	MC512PA	1SNK148122R0000	1	10.00
V1 (x100)	100	White <input type="checkbox"/>	MC512PA	1SNK148132R0000	1	10.00
V2 (x100)	100	White <input type="checkbox"/>	MC512PA	1SNK148142R0000	1	10.00
V3 (x100)	100	White <input type="checkbox"/>	MC512PA	1SNK148152R0000	1	10.00
W1 (x100)	100	White <input type="checkbox"/>	MC512PA	1SNK148162R0000	1	10.00
W2 (x100)	100	White <input type="checkbox"/>	MC512PA	1SNK148172R0000	1	10.00
W3 (x100)	100	White <input type="checkbox"/>	MC512PA	1SNK148182R0000	1	10.00
+24V (x100)	100	White <input type="checkbox"/>	MC512PA	1SNK148192R0000	1	10.00
+48V (x100)	100	White <input type="checkbox"/>	MC512PA	1SNK148202R0000	1	10.00
-24V (x100)	100	White <input type="checkbox"/>	MC512PA	1SNK148212R0000	1	10.00
-48V (x100)	100	White <input type="checkbox"/>	MC512PA	1SNK148222R0000	1	10.00
L1-L2-L3-N-PE (x20)	100	White <input type="checkbox"/>	MC512PA	1SNK149002R0000	1	10.00
U1-U2-U3-V1-V2-V3-W1-W2-W3 (x10) + U1 (x10)	100	White <input type="checkbox"/>	MC512PA	1SNK149012R0000	1	10.00

Terminal block markers

Blank card in polycarbonate - 6 mm 0.236 in spacing



MC612



HTP500-V2

MC612 terminal block markers

Description

- MC612 marker card in polycarbonate for high marking quality, durability and speed when marked with the HTP500 printer,
- Excellent marking durability in the most severe environments,
- Improved marking visibility thanks to the increased marking surface +20% (12 mm 0.472 in).

Main technical data

Material	Flammability	Maximum printed digits				Dimensions	
		mm		inches			
Polycarbonate	V0	Horizontal	3	Vertical	8	5.6 x 12	0.220 x 0.472

Ordering details

Description	Number of markers per card	Color	Type	Part number	Pkg card	Weight
						(1 pce) g
Blank card	39	White <input type="checkbox"/>	MC612	1SNK15000R0000	22	10.00
		Yellow <input checked="" type="checkbox"/>	MC612-YL	1SNK150004R0000	22	10.00

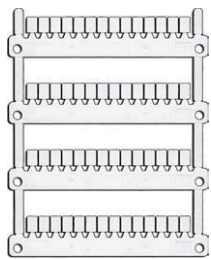

MG-CPM-13



MG3 KIT

MG-CPM-13 terminal block markers

Description

- MG-CPM-13 41791 and 41741 markers are used for marking 6 mm 0.236 in spacing SNK terminal blocks,
- Provide an elevate mechanical robustness, high dimensional stability and are halogen free,
- Single application on terminal block,
- 35 cards per packing.

Main technical data

Material	Flammability	Maximum printed digits				Dimensions	
		mm		inches			
Polycarbonate	V0	Horizontal	3	Vertical	8	5.6 x 12	0.236 x 0.472

Ordering details

Description	Number of markers per card	Color	Type	Part number	Pkg marker	Weight
						(1 pce) g
Blank card	48	White <input type="checkbox"/>	MG-CPM 13 41791	1SNB041791R0612	1680	0.273
		Yellow <input checked="" type="checkbox"/>	MG-CPM 13 41741	1SNB041741R0612	1680	0.273

Marking systems

Description	Type	Part number	Pkg qty	Weight (1 pce) g
Thermal transfer printer	MG3 KIT	1SNB419001R0000	1	12600.00

Marking systems accessories

Description	Type	Part number	Pkg qty	Weight (1 pce) g
Support plate for MG-CPM-13	MG2-ETB 991016	1SNB991016R0000	1	100.00

Terminal block markers

Blank card in polyamide - 6 mm 0.236 in spacing



MC612



AMS 600

MC612PA terminal block markers

Description

- MC612PA marker card in polyamide to be marked on AMS 600 marking table for medium scale volumes and standard industrial applications,
- Terminal blocks are directly independent after strip mounting,
- Improved marking visibility thanks to the increased marking surface +20% (12 mm 0.472 in).

Main technical data

Material	Flammability	Maximum printed digits		Dimensions	
		Horizontal	Vertical	mm	inches
Polyamide	V2	3	8	5.6 x 12	0.220 x 0.472

Ordering details

Description	Number of markers per card	Color	Type	Part Number	Pkg card	Weight (1 pce) g
Blank card	100	White <input type="checkbox"/>	MC612PA	1SNK159999R0000	20	11.00

Marking systems

Description	Type	Part Number	Pkg qty	Weight (1 pce) g
AMS plotter	AMS 600 KIT	1SNA360000R2400	1	12600.00

Marking systems accessories

Description	Type	Part Number	Pkg qty	Weight (1 pce) g
Marking support plate for MC PA marker cards (3 MC PA marker cards per plate)	SPRC 30-3	1SNA360039R1700	1	300.00

MC612PA terminal block markers

Pre-printed marker card for horizontal terminal block assembly



MC612PA



6 mm 0.236 in spacing

Description

Save printing time with our large pre-printed cards offer with pre-printed numbers, letters or symbols.

Main technical data

Material	Flammability	Dimensions	
		mm	inches
Polyamide	V2	5.6 x 12	0.220 x 0.472

Ordering details

Description	Number of markers per card	Color	Type	Part Number	Pkg card	Weight (1 pce) g
0->9 (x10)	100	White <input type="checkbox"/>	MC612PA	1SNK150091R0000	1	11.00
1->10 (x10)	100	White <input type="checkbox"/>	MC612PA	1SNK150011R0000	1	11.00
11->20 (x10)	100	White <input type="checkbox"/>	MC612PA	1SNK150021R0000	1	11.00
21->30 (x10)	100	White <input type="checkbox"/>	MC612PA	1SNK150031R0000	1	11.00
31->40 (x10)	100	White <input type="checkbox"/>	MC612PA	1SNK150041R0000	1	11.00
41->50 (x10)	100	White <input type="checkbox"/>	MC612PA	1SNK150051R0000	1	11.00
51->60 (x10)	100	White <input type="checkbox"/>	MC612PA	1SNK150061R0000	1	11.00
61->70 (x10)	100	White <input type="checkbox"/>	MC612PA	1SNK150071R0000	1	11.00
71->80 (x10)	100	White <input type="checkbox"/>	MC612PA	1SNK150081R0000	1	11.00
81->90 (x10)	100	White <input type="checkbox"/>	MC612PA	1SNK150083R0000	1	11.00
91->100 (x10)	100	White <input type="checkbox"/>	MC612PA	1SNK150101R0000	1	11.00
101->110 (x10)	100	White <input type="checkbox"/>	MC612PA	1SNK150111R0000	1	11.00
111->120 (x10)	100	White <input type="checkbox"/>	MC612PA	1SNK150121R0000	1	11.00
121->130 (x10)	100	White <input type="checkbox"/>	MC612PA	1SNK150131R0000	1	11.00
131->140 (x10)	100	White <input type="checkbox"/>	MC612PA	1SNK150141R0000	1	11.00
141->150 (x10)	100	White <input type="checkbox"/>	MC612PA	1SNK150151R0000	1	11.00
151->160 (x10)	100	White <input type="checkbox"/>	MC612PA	1SNK150161R0000	1	11.00
161->170 (x10)	100	White <input type="checkbox"/>	MC612PA	1SNK150171R0000	1	11.00
171->180 (x10)	100	White <input type="checkbox"/>	MC612PA	1SNK150181R0000	1	11.00
181->190 (x10)	100	White <input type="checkbox"/>	MC612PA	1SNK150191R0000	1	11.00
191->200 (x10)	100	White <input type="checkbox"/>	MC612PA	1SNK150201R0000	1	11.00
1->100	100	White <input type="checkbox"/>	MC612PA	1SNK155011R0000	1	11.00
101->200	100	White <input type="checkbox"/>	MC612PA	1SNK155021R0000	1	11.00
201->300	100	White <input type="checkbox"/>	MC612PA	1SNK155031R0000	1	11.00
301->400	100	White <input type="checkbox"/>	MC612PA	1SNK155041R0000	1	11.00
401->500	100	White <input type="checkbox"/>	MC612PA	1SNK155051R0000	1	11.00
501->600	100	White <input type="checkbox"/>	MC612PA	1SNK155061R0000	1	11.00
601->700	100	White <input type="checkbox"/>	MC612PA	1SNK155071R0000	1	11.00
701->800	100	White <input type="checkbox"/>	MC612PA	1SNK155081R0000	1	11.00
801->900	100	White <input type="checkbox"/>	MC612PA	1SNK155091R0000	1	11.00
A (x100)	100	White <input type="checkbox"/>	MC612PA	1SNK156011R0000	1	11.00
B (x100)	100	White <input type="checkbox"/>	MC612PA	1SNK156021R0000	1	11.00
C (x100)	100	White <input type="checkbox"/>	MC612PA	1SNK156031R0000	1	11.00
D (x100)	100	White <input type="checkbox"/>	MC612PA	1SNK156041R0000	1	11.00
E (x100)	100	White <input type="checkbox"/>	MC612PA	1SNK156051R0000	1	11.00
F (x100)	100	White <input type="checkbox"/>	MC612PA	1SNK156061R0000	1	11.00
G (x100)	100	White <input type="checkbox"/>	MC612PA	1SNK156071R0000	1	11.00
H (x100)	100	White <input type="checkbox"/>	MC612PA	1SNK156081R0000	1	11.00
I (x100)	100	White <input type="checkbox"/>	MC612PA	1SNK156091R0000	1	11.00
J (x100)	100	White <input type="checkbox"/>	MC612PA	1SNK156101R0000	1	11.00
K (x100)	100	White <input type="checkbox"/>	MC612PA	1SNK156111R0000	1	11.00
L (x100)	100	White <input type="checkbox"/>	MC612PA	1SNK156121R0000	1	11.00
M (x100)	100	White <input type="checkbox"/>	MC612PA	1SNK156131R0000	1	11.00
N (x100)	100	White <input type="checkbox"/>	MC612PA	1SNK156141R0000	1	11.00
O (x100)	100	White <input type="checkbox"/>	MC612PA	1SNK156151R0000	1	11.00
P (x100)	100	White <input type="checkbox"/>	MC612PA	1SNK156161R0000	1	11.00
Q (x100)	100	White <input type="checkbox"/>	MC612PA	1SNK156171R0000	1	11.00
R (x100)	100	White <input type="checkbox"/>	MC612PA	1SNK156181R0000	1	11.00
S (x100)	100	White <input type="checkbox"/>	MC612PA	1SNK156191R0000	1	11.00
T (x100)	100	White <input type="checkbox"/>	MC612PA	1SNK156201R0000	1	11.00
U (x100)	100	White <input type="checkbox"/>	MC612PA	1SNK156211R0000	1	11.00
V (x100)	100	White <input type="checkbox"/>	MC612PA	1SNK156221R0000	1	11.00
W (x100)	100	White <input type="checkbox"/>	MC612PA	1SNK156231R0000	1	11.00

Continue on next page →

1SNK16007S0201 - Rev. A

MC612PA terminal block markers

Pre-printed marker card for horizontal terminal block assembly



MC612PA



6 mm 0.236 in spacing

Ordering details

Description	Number of markers per card	Color	Type	Part Number	Pkg card	Weight (1 pce) g
← Continuation of previous page						
X (x100)	100	White <input type="checkbox"/>	MC612PA	1SNK156241R0000	1	11.00
Y (x100)	100	White <input type="checkbox"/>	MC612PA	1SNK156251R0000	1	11.00
Z (x100)	100	White <input type="checkbox"/>	MC612PA	1SNK156261R0000	1	11.00
0 (x100)	100	White <input type="checkbox"/>	MC612PA	1SNK157001R0000	1	11.00
1 (x100)	100	White <input type="checkbox"/>	MC612PA	1SNK157011R0000	1	11.00
2 (x100)	100	White <input type="checkbox"/>	MC612PA	1SNK157021R0000	1	11.00
3 (x100)	100	White <input type="checkbox"/>	MC612PA	1SNK157031R0000	1	11.00
4 (x100)	100	White <input type="checkbox"/>	MC612PA	1SNK157041R0000	1	11.00
5 (x100)	100	White <input type="checkbox"/>	MC612PA	1SNK157051R0000	1	11.00
6 (x100)	100	White <input type="checkbox"/>	MC612PA	1SNK157061R0000	1	11.00
7 (x100)	100	White <input type="checkbox"/>	MC612PA	1SNK157071R0000	1	11.00
8 (x100)	100	White <input type="checkbox"/>	MC612PA	1SNK157081R0000	1	11.00
9 (x100)	100	White <input type="checkbox"/>	MC612PA	1SNK157091R0000	1	11.00
+ (x100)	100	White <input type="checkbox"/>	MC612PA	1SNK158001R0000	1	11.00
- (x100)	100	White <input type="checkbox"/>	MC612PA	1SNK158011R0000	1	11.00
~ (x100)	100	White <input type="checkbox"/>	MC612PA	1SNK158021R0000	1	11.00
= (x100)	100	White <input type="checkbox"/>	MC612PA	1SNK158031R0000	1	11.00
Ground (x100)	100	White <input type="checkbox"/>	MC612PA	1SNK158041R0000	1	11.00
L1 (x100)	100	White <input type="checkbox"/>	MC612PA	1SNK158051R0000	1	11.00
L2 (x100)	100	White <input type="checkbox"/>	MC612PA	1SNK158061R0000	1	11.00
L3 (x100)	100	White <input type="checkbox"/>	MC612PA	1SNK158071R0000	1	11.00
PE (x100)	100	White <input type="checkbox"/>	MC612PA	1SNK158091R0000	1	11.00
U1 (x100)	100	White <input type="checkbox"/>	MC612PA	1SNK158101R0000	1	11.00
U2 (x100)	100	White <input type="checkbox"/>	MC612PA	1SNK158111R0000	1	11.00
U3 (x100)	100	White <input type="checkbox"/>	MC612PA	1SNK158121R0000	1	11.00
V1 (x100)	100	White <input type="checkbox"/>	MC612PA	1SNK158131R0000	1	11.00
V2 (x100)	100	White <input type="checkbox"/>	MC612PA	1SNK158141R0000	1	11.00
V3 (x100)	100	White <input type="checkbox"/>	MC612PA	1SNK158151R0000	1	11.00
W1 (x100)	100	White <input type="checkbox"/>	MC612PA	1SNK158161R0000	1	11.00
W2 (x100)	100	White <input type="checkbox"/>	MC612PA	1SNK158171R0000	1	11.00
W3 (x100)	100	White <input type="checkbox"/>	MC612PA	1SNK158181R0000	1	11.00
L1-L2-L3-N-PE (x20)	100	White <input type="checkbox"/>	MC612PA	1SNK159001R0000	1	11.00
U1-U2-U3-V1-V2-V3-W1-W2-W3 (x10) + U1 (x10)	100	White <input type="checkbox"/>	MC612PA	1SNK159011R0000	1	11.00

MC612PA terminal block markers

Pre-printed marker card for vertical terminal block assembly



MC612PA



6 mm 0.236 in spacing

Description

Save printing time with our large pre-printed cards offer with pre-printed numbers, letters or symbols.

Main technical data

Material	Flammability	Dimensions	
		mm	inches
Polyamide	V2	5.6 x 12	0.220 x 0.472

Ordering details

Description	Number of markers per card	Color	Type	Part Number	Pkg card	Weight (1 pce) g
0->9 (x10)	100	White	<input type="checkbox"/> MC612PA	1SNK150092R0000	1	11.00
1->10 (x10)	100	White	<input type="checkbox"/> MC612PA	1SNK150012R0000	1	11.00
11->20 (x10)	100	White	<input type="checkbox"/> MC612PA	1SNK150022R0000	1	11.00
21->30 (x10)	100	White	<input type="checkbox"/> MC612PA	1SNK150032R0000	1	11.00
31->40 (x10)	100	White	<input type="checkbox"/> MC612PA	1SNK150042R0000	1	11.00
41->50 (x10)	100	White	<input type="checkbox"/> MC612PA	1SNK150052R0000	1	11.00
51->60 (x10)	100	White	<input type="checkbox"/> MC612PA	1SNK150062R0000	1	11.00
61->70 (x10)	100	White	<input type="checkbox"/> MC612PA	1SNK150072R0000	1	11.00
71->80 (x10)	100	White	<input type="checkbox"/> MC612PA	1SNK150082R0000	1	11.00
81->90 (x10)	100	White	<input type="checkbox"/> MC612PA	1SNK150084R0000	1	11.00
91->100 (x10)	100	White	<input type="checkbox"/> MC612PA	1SNK150102R0000	1	11.00
101->110 (x10)	100	White	<input type="checkbox"/> MC612PA	1SNK150112R0000	1	11.00
111->120 (x10)	100	White	<input type="checkbox"/> MC612PA	1SNK150122R0000	1	11.00
121->130 (x10)	100	White	<input type="checkbox"/> MC612PA	1SNK150132R0000	1	11.00
131->140 (x10)	100	White	<input type="checkbox"/> MC612PA	1SNK150142R0000	1	11.00
141->150 (x10)	100	White	<input type="checkbox"/> MC612PA	1SNK150152R0000	1	11.00
151->160 (x10)	100	White	<input type="checkbox"/> MC612PA	1SNK150162R0000	1	11.00
161->170 (x10)	100	White	<input type="checkbox"/> MC612PA	1SNK150172R0000	1	11.00
171->180 (x10)	100	White	<input type="checkbox"/> MC612PA	1SNK150182R0000	1	11.00
181->190 (x10)	100	White	<input type="checkbox"/> MC612PA	1SNK150192R0000	1	11.00
191->200 (x10)	100	White	<input type="checkbox"/> MC612PA	1SNK150202R0000	1	11.00
1->100	100	White	<input type="checkbox"/> MC612PA	1SNK155012R0000	1	11.00
101->200	100	White	<input type="checkbox"/> MC612PA	1SNK155022R0000	1	11.00
201->300	100	White	<input type="checkbox"/> MC612PA	1SNK155032R0000	1	11.00
301->400	100	White	<input type="checkbox"/> MC612PA	1SNK155042R0000	1	11.00
401->500	100	White	<input type="checkbox"/> MC612PA	1SNK155052R0000	1	11.00
501->600	100	White	<input type="checkbox"/> MC612PA	1SNK155062R0000	1	11.00
601->700	100	White	<input type="checkbox"/> MC612PA	1SNK155072R0000	1	11.00
701->800	100	White	<input type="checkbox"/> MC612PA	1SNK155082R0000	1	11.00
801->900	100	White	<input type="checkbox"/> MC612PA	1SNK155092R0000	1	11.00
901->1000	100	White	<input type="checkbox"/> MC612PA	1SNK155102R0000	1	11.00
A (x100)	100	White	<input type="checkbox"/> MC612PA	1SNK156012R0000	1	11.00
B (x100)	100	White	<input type="checkbox"/> MC612PA	1SNK156022R0000	1	11.00
C (x100)	100	White	<input type="checkbox"/> MC612PA	1SNK156032R0000	1	11.00
D (x100)	100	White	<input type="checkbox"/> MC612PA	1SNK156042R0000	1	11.00
E (x100)	100	White	<input type="checkbox"/> MC612PA	1SNK156052R0000	1	11.00
F (x100)	100	White	<input type="checkbox"/> MC612PA	1SNK156062R0000	1	11.00
G (x100)	100	White	<input type="checkbox"/> MC612PA	1SNK156072R0000	1	11.00
H (x100)	100	White	<input type="checkbox"/> MC612PA	1SNK156082R0000	1	11.00
I (x100)	100	White	<input type="checkbox"/> MC612PA	1SNK156092R0000	1	11.00
J (x100)	100	White	<input type="checkbox"/> MC612PA	1SNK156102R0000	1	11.00
K (x100)	100	White	<input type="checkbox"/> MC612PA	1SNK156112R0000	1	11.00
L (x100)	100	White	<input type="checkbox"/> MC612PA	1SNK156122R0000	1	11.00
M (x100)	100	White	<input type="checkbox"/> MC612PA	1SNK156132R0000	1	11.00
N (x100)	100	White	<input type="checkbox"/> MC612PA	1SNK156142R0000	1	11.00
O (x100)	100	White	<input type="checkbox"/> MC612PA	1SNK156152R0000	1	11.00
P (x100)	100	White	<input type="checkbox"/> MC612PA	1SNK156162R0000	1	11.00
Q (x100)	100	White	<input type="checkbox"/> MC612PA	1SNK156172R0000	1	11.00
R (x100)	100	White	<input type="checkbox"/> MC612PA	1SNK156182R0000	1	11.00
S (x100)	100	White	<input type="checkbox"/> MC612PA	1SNK156192R0000	1	11.00
T (x100)	100	White	<input type="checkbox"/> MC612PA	1SNK156202R0000	1	11.00
U (x100)	100	White	<input type="checkbox"/> MC612PA	1SNK156212R0000	1	11.00
V (x100)	100	White	<input type="checkbox"/> MC612PA	1SNK156222R0000	1	11.00
W (x100)	100	White	<input type="checkbox"/> MC612PA	1SNK156232R0000	1	11.00
X (x100)	100	White	<input type="checkbox"/> MC612PA	1SNK156242R0000	1	11.00

Continue on next page →

1SNK160009S0201 - Rev. A

MC612PA terminal block markers

Pre-printed marker card for vertical terminal block assembly



MC612PA



6 mm 0.236 in spacing

Ordering details

Description	Number of markers per card	Color	Type	Part Number	Pkg card	Weight (1 pce) g
← Continuation of previous page						
Y (x100)	100	White	MC612PA	1SNK156252R0000	1	11.00
Z (x100)	100	White	MC612PA	1SNK156262R0000	1	11.00
0 (x100)	100	White	MC612PA	1SNK157002R0000	1	11.00
1 (x100)	100	White	MC612PA	1SNK157012R0000	1	11.00
2 (x100)	100	White	MC612PA	1SNK157022R0000	1	11.00
3 (x100)	100	White	MC612PA	1SNK157032R0000	1	11.00
4 (x100)	100	White	MC612PA	1SNK157042R0000	1	11.00
5 (x100)	100	White	MC612PA	1SNK157052R0000	1	11.00
6 (x100)	100	White	MC612PA	1SNK157062R0000	1	11.00
7 (x100)	100	White	MC612PA	1SNK157072R0000	1	11.00
8 (x100)	100	White	MC612PA	1SNK157082R0000	1	11.00
9 (x100)	100	White	MC612PA	1SNK157092R0000	1	11.00
+ (x100)	100	White	MC612PA	1SNK158002R0000	1	11.00
- (x100)	100	White	MC612PA	1SNK158012R0000	1	11.00
~ (x100)	100	White	MC612PA	1SNK158022R0000	1	11.00
= (x100)	100	White	MC612PA	1SNK158032R0000	1	11.00
± (x100)	100	White	MC612PA	1SNK158042R0000	1	11.00
L1 (x100)	100	White	MC612PA	1SNK158052R0000	1	11.00
L2 (x100)	100	White	MC612PA	1SNK158062R0000	1	11.00
L3 (x100)	100	White	MC612PA	1SNK158072R0000	1	11.00
PE (x100)	100	White	MC612PA	1SNK158092R0000	1	11.00
U1 (x100)	100	White	MC612PA	1SNK158102R0000	1	11.00
U2 (x100)	100	White	MC612PA	1SNK158112R0000	1	11.00
U3 (x100)	100	White	MC612PA	1SNK158122R0000	1	11.00
V1 (x100)	100	White	MC612PA	1SNK158132R0000	1	11.00
V2 (x100)	100	White	MC612PA	1SNK158142R0000	1	11.00
V3 (x100)	100	White	MC612PA	1SNK158152R0000	1	11.00
W1 (x100)	100	White	MC612PA	1SNK158162R0000	1	11.00
W2 (x100)	100	White	MC612PA	1SNK158172R0000	1	11.00
W3 (x100)	100	White	MC612PA	1SNK158182R0000	1	11.00
+24V (x100)	100	White	MC612PA	1SNK158192R0000	1	11.00
+48V (x100)	100	White	MC612PA	1SNK158202R0000	1	11.00
-24V (x100)	100	White	MC612PA	1SNK158212R0000	1	11.00
-48V (x100)	100	White	MC612PA	1SNK158222R0000	1	11.00
L1-L2-L3-N-PE (x20)	100	White	MC612PA	1SNK159002R0000	1	11.00
U1-U2-U3-V1-V2-V3-W1-W2-W3 (x10) + U1 (x10)	100	White	MC612PA	1SNK159012R0000	1	11.00

MC812 terminal block markers

Blank card in polycarbonate or polyamide - 8 mm 0.315 in spacing



MC812



HTP500-V2

MC812 terminal block markers

Description

- MC812 marker card in polycarbonate for high marking quality, durability and speed when marked with the HTP500 printer,
- Excellent marking durability in the most severe environments,
- Improved marking visibility thanks to the increased marking surface +20% (12 mm 0.472 in)

Main technical data

Material	Flammability	Maximum printed digits				Dimensions	
		mm		inches			
Polycarbonate	V0	Horizontal	4	Vertical	8	7.6 x 12	0.299 x 0.472

Ordering details

Description	Number of markers per card	Color	Type	Part number	Pkg card	Weight (1 pce) g
Blank card	30	White <input type="checkbox"/>	MC812	1SNK160000R0000	22	10.00
		Yellow <input type="checkbox"/>	MC812-YL	1SNK160004R0000	22	10.00



MC812PA



AMS 600

MC812PA terminal block markers

Description

- MC812PA marker card in polyamide to be marked on AMS 600 marking table for medium scale volumes and standard industrial applications,
- Terminal blocks are directly independent after strip mounting,
- Improved marking visibility thanks to the increased marking surface +20% (12 mm 0.472 in)

Main technical data

Material	Flammability	Maximum printed digits				Dimensions	
		mm		inches			
Polyamide	V2	Horizontal	3	Vertical	8	7.6 x 12	0.299 x 0.472

Ordering details

Description	Number of markers per card	Color	Type	Part number	Pkg card	Weight (1 pce) g
Blank card	100	White <input type="checkbox"/>	MC812PA	1SNK169999R0000	20	14.00

Marking systems

Description	Type	Part number	Pkg qty	Weight (1 pce) g
AMS plotter	AMS 600 KIT	1SNA360000R2400	1	12600.00

Marking systems accessories

Description	Type	Part number	Pkg qty	Weight (1 pce) g
Marking support plate for MC PA marker cards (3 MC PA marker cards per plate)	SPRC 30-3	1SNA360039R1700	1	300.00

MC812PA terminal block markers

Pre-printed marker card for horizontal terminal block assembly



MC812PA



8 mm 0.315 in spacing

Description

Save printing time with our large pre-printed cards offer with pre-printed numbers, letters or symbols.

Main technical data

Material	Flammability	Dimensions	
		mm	inches
Polyamide	V2	7.6 x 12	0.299 x 0.472

Ordering details

Description	Number of markers per card	Color	Type	Part Number	Pkg card	Weight (1 pce) g
0->9 (x10)	100	White <input type="checkbox"/>	MC812PA	1SNK160091R0000	1	14.00
1->10 (x10)	100	White <input type="checkbox"/>	MC812PA	1SNK160011R0000	1	14.00
11->20 (x10)	100	White <input type="checkbox"/>	MC812PA	1SNK160021R0000	1	14.00
21->30 (x10)	100	White <input type="checkbox"/>	MC812PA	1SNK160031R0000	1	14.00
31->40 (x10)	100	White <input type="checkbox"/>	MC812PA	1SNK160041R0000	1	14.00
41->50 (x10)	100	White <input type="checkbox"/>	MC812PA	1SNK160051R0000	1	14.00
51->60 (x10)	100	White <input type="checkbox"/>	MC812PA	1SNK160061R0000	1	14.00
61->70 (x10)	100	White <input type="checkbox"/>	MC812PA	1SNK160071R0000	1	14.00
71->80 (x10)	100	White <input type="checkbox"/>	MC812PA	1SNK160081R0000	1	14.00
81->90 (x10)	100	White <input type="checkbox"/>	MC812PA	1SNK160083R0000	1	14.00
91->100 (x10)	100	White <input type="checkbox"/>	MC812PA	1SNK160101R0000	1	14.00
101->110 (x10)	100	White <input type="checkbox"/>	MC812PA	1SNK160111R0000	1	14.00
111->120 (x10)	100	White <input type="checkbox"/>	MC812PA	1SNK160121R0000	1	14.00
121->130 (x10)	100	White <input type="checkbox"/>	MC812PA	1SNK160131R0000	1	14.00
131->140 (x10)	100	White <input type="checkbox"/>	MC812PA	1SNK160141R0000	1	14.00
141->150 (x10)	100	White <input type="checkbox"/>	MC812PA	1SNK160151R0000	1	14.00
151->160 (x10)	100	White <input type="checkbox"/>	MC812PA	1SNK160161R0000	1	14.00
161->170 (x10)	100	White <input type="checkbox"/>	MC812PA	1SNK160171R0000	1	14.00
171->180 (x10)	100	White <input type="checkbox"/>	MC812PA	1SNK160181R0000	1	14.00
181->190 (x10)	100	White <input type="checkbox"/>	MC812PA	1SNK160191R0000	1	14.00
191->200 (x10)	100	White <input type="checkbox"/>	MC812PA	1SNK160201R0000	1	14.00
1->100	100	White <input type="checkbox"/>	MC812PA	1SNK165011R0000	1	14.00
101->200	100	White <input type="checkbox"/>	MC812PA	1SNK165021R0000	1	14.00
201->300	100	White <input type="checkbox"/>	MC812PA	1SNK165031R0000	1	14.00
301->400	100	White <input type="checkbox"/>	MC812PA	1SNK165041R0000	1	14.00
401->500	100	White <input type="checkbox"/>	MC812PA	1SNK165051R0000	1	14.00
501->600	100	White <input type="checkbox"/>	MC812PA	1SNK165061R0000	1	14.00
601->700	100	White <input type="checkbox"/>	MC812PA	1SNK165071R0000	1	14.00
701->800	100	White <input type="checkbox"/>	MC812PA	1SNK165081R0000	1	14.00
801->900	100	White <input type="checkbox"/>	MC812PA	1SNK165091R0000	1	14.00
A (x100)	100	White <input type="checkbox"/>	MC812PA	1SNK166011R0000	1	14.00
B (x100)	100	White <input type="checkbox"/>	MC812PA	1SNK166021R0000	1	14.00
C (x100)	100	White <input type="checkbox"/>	MC812PA	1SNK166031R0000	1	14.00
D (x100)	100	White <input type="checkbox"/>	MC812PA	1SNK166041R0000	1	14.00
E (x100)	100	White <input type="checkbox"/>	MC812PA	1SNK166051R0000	1	14.00
F (x100)	100	White <input type="checkbox"/>	MC812PA	1SNK166061R0000	1	14.00
G (x100)	100	White <input type="checkbox"/>	MC812PA	1SNK166071R0000	1	14.00
H (x100)	100	White <input type="checkbox"/>	MC812PA	1SNK166081R0000	1	14.00
I (x100)	100	White <input type="checkbox"/>	MC812PA	1SNK166091R0000	1	14.00
J (x100)	100	White <input type="checkbox"/>	MC812PA	1SNK166101R0000	1	14.00
K (x100)	100	White <input type="checkbox"/>	MC812PA	1SNK166111R0000	1	14.00
L (x100)	100	White <input type="checkbox"/>	MC812PA	1SNK166121R0000	1	14.00
M (x100)	100	White <input type="checkbox"/>	MC812PA	1SNK166131R0000	1	14.00
N (x100)	100	White <input type="checkbox"/>	MC812PA	1SNK166141R0000	1	14.00
O (x100)	100	White <input type="checkbox"/>	MC812PA	1SNK166151R0000	1	14.00
P (x100)	100	White <input type="checkbox"/>	MC812PA	1SNK166161R0000	1	14.00
Q (x100)	100	White <input type="checkbox"/>	MC812PA	1SNK166171R0000	1	14.00
R (x100)	100	White <input type="checkbox"/>	MC812PA	1SNK166181R0000	1	14.00
S (x100)	100	White <input type="checkbox"/>	MC812PA	1SNK166191R0000	1	14.00
T (x100)	100	White <input type="checkbox"/>	MC812PA	1SNK166201R0000	1	14.00
U (x100)	100	White <input type="checkbox"/>	MC812PA	1SNK166211R0000	1	14.00
V (x100)	100	White <input type="checkbox"/>	MC812PA	1SNK166221R0000	1	14.00

Continue on next page →

1SNK160010S0201 - Rev. A

MC812PA terminal block markers

Pre-printed marker card for horizontal terminal block assembly



MC812PA



8 mm 0.315 in spacing

Ordering details

Description	Number of markers per card	Color	Type	Part Number	Pkg card	Weight (1 pce) g
← Continuation of previous page						
W (x100)	100	White <input type="checkbox"/>	MC812PA	1SNK166231R0000	1	14.00
X (x100)	100	White <input type="checkbox"/>	MC812PA	1SNK166241R0000	1	14.00
Y (x100)	100	White <input type="checkbox"/>	MC812PA	1SNK166251R0000	1	14.00
Z (x100)	100	White <input type="checkbox"/>	MC812PA	1SNK166261R0000	1	14.00
0 (x100)	100	White <input type="checkbox"/>	MC812PA	1SNK167001R0000	1	14.00
1 (x100)	100	White <input type="checkbox"/>	MC812PA	1SNK167011R0000	1	14.00
2 (x100)	100	White <input type="checkbox"/>	MC812PA	1SNK167021R0000	1	14.00
3 (x100)	100	White <input type="checkbox"/>	MC812PA	1SNK167031R0000	1	14.00
4 (x100)	100	White <input type="checkbox"/>	MC812PA	1SNK167041R0000	1	14.00
5 (x100)	100	White <input type="checkbox"/>	MC812PA	1SNK167051R0000	1	14.00
6 (x100)	100	White <input type="checkbox"/>	MC812PA	1SNK167061R0000	1	14.00
7 (x100)	100	White <input type="checkbox"/>	MC812PA	1SNK167071R0000	1	14.00
8 (x100)	100	White <input type="checkbox"/>	MC812PA	1SNK167081R0000	1	14.00
9 (x100)	100	White <input type="checkbox"/>	MC812PA	1SNK167091R0000	1	14.00
+ (x100)	100	White <input type="checkbox"/>	MC812PA	1SNK168001R0000	1	14.00
- (x100)	100	White <input type="checkbox"/>	MC812PA	1SNK168011R0000	1	14.00
~ (x100)	100	White <input type="checkbox"/>	MC812PA	1SNK168021R0000	1	14.00
= (x100)	100	White <input type="checkbox"/>	MC812PA	1SNK168031R0000	1	14.00
≡ (x100)	100	White <input type="checkbox"/>	MC812PA	1SNK168041R0000	1	14.00
L1 (x100)	100	White <input type="checkbox"/>	MC812PA	1SNK168051R0000	1	14.00
L2 (x100)	100	White <input type="checkbox"/>	MC812PA	1SNK168061R0000	1	14.00
L3 (x100)	100	White <input type="checkbox"/>	MC812PA	1SNK168071R0000	1	14.00
PE (x100)	100	White <input type="checkbox"/>	MC812PA	1SNK168091R0000	1	14.00
U1 (x100)	100	White <input type="checkbox"/>	MC812PA	1SNK168101R0000	1	14.00
U2 (x100)	100	White <input type="checkbox"/>	MC812PA	1SNK168111R0000	1	14.00
U3 (x100)	100	White <input type="checkbox"/>	MC812PA	1SNK168121R0000	1	14.00
V1 (x100)	100	White <input type="checkbox"/>	MC812PA	1SNK168131R0000	1	14.00
V2 (x100)	100	White <input type="checkbox"/>	MC812PA	1SNK168141R0000	1	14.00
V3 (x100)	100	White <input type="checkbox"/>	MC812PA	1SNK168151R0000	1	14.00
W1 (x100)	100	White <input type="checkbox"/>	MC812PA	1SNK168161R0000	1	14.00
W2 (x100)	100	White <input type="checkbox"/>	MC812PA	1SNK168171R0000	1	14.00
W3 (x100)	100	White <input type="checkbox"/>	MC812PA	1SNK168181R0000	1	14.00
L1-L2-L3-N-PE (x20)	100	White <input type="checkbox"/>	MC812PA	1SNK169001R0000	1	14.00
U1-U2-U3-V1-V2-V3-W1-W2-W3 (x10) + U1 (x10)	100	White <input type="checkbox"/>	MC812PA	1SNK169011R0000	1	14.00

MC812PA terminal block markers

Pre-printed marker card for vertical terminal block assembly



MC812PA



8 mm 0.315 in spacing

Description

Save printing time with our large pre-printed cards offer with pre-printed numbers, letters or symbols.

Main technical data

Material	Flammability	Dimensions	
		mm	inches
Polyamide	V2	7.6 x 12	0.299 x 0.472

Ordering details

Description	Number of markers per card	Color	Type	Part Number	Pkg card	Weight (1 pce) g
0->9 (x10)	100	White	MC812PA	1SNK160092R0000	1	14.00
1->10 (x10)	100	White	MC812PA	1SNK160012R0000	1	14.00
11->20 (x10)	100	White	MC812PA	1SNK160022R0000	1	14.00
21->30 (x10)	100	White	MC812PA	1SNK160032R0000	1	14.00
31->40 (x10)	100	White	MC812PA	1SNK160042R0000	1	14.00
41->50 (x10)	100	White	MC812PA	1SNK160052R0000	1	14.00
51->60 (x10)	100	White	MC812PA	1SNK160062R0000	1	14.00
61->70 (x10)	100	White	MC812PA	1SNK160072R0000	1	14.00
71->80 (x10)	100	White	MC812PA	1SNK160082R0000	1	14.00
81->90 (x10)	100	White	MC812PA	1SNK160084R0000	1	14.00
91->100 (x10)	100	White	MC812PA	1SNK160102R0000	1	14.00
101->110 (x10)	100	White	MC812PA	1SNK160112R0000	1	14.00
111->120 (x10)	100	White	MC812PA	1SNK160122R0000	1	14.00
121->130 (x10)	100	White	MC812PA	1SNK160132R0000	1	14.00
131->140 (x10)	100	White	MC812PA	1SNK160142R0000	1	14.00
141->150 (x10)	100	White	MC812PA	1SNK160152R0000	1	14.00
151->160 (x10)	100	White	MC812PA	1SNK160162R0000	1	14.00
161->170 (x10)	100	White	MC812PA	1SNK160172R0000	1	14.00
171->180 (x10)	100	White	MC812PA	1SNK160182R0000	1	14.00
181->190 (x10)	100	White	MC812PA	1SNK160192R0000	1	14.00
191->200 (x10)	100	White	MC812PA	1SNK160202R0000	1	14.00
1->100	100	White	MC812PA	1SNK165012R0000	1	14.00
101->200	100	White	MC812PA	1SNK165022R0000	1	14.00
201->300	100	White	MC812PA	1SNK165032R0000	1	14.00
301->400	100	White	MC812PA	1SNK165042R0000	1	14.00
401->500	100	White	MC812PA	1SNK165052R0000	1	14.00
501->600	100	White	MC812PA	1SNK165062R0000	1	14.00
601->700	100	White	MC812PA	1SNK165072R0000	1	14.00
701->800	100	White	MC812PA	1SNK165082R0000	1	14.00
801->900	100	White	MC812PA	1SNK165092R0000	1	14.00
901->1000	100	White	MC812PA	1SNK165102R0000	1	14.00
A (x100)	100	White	MC812PA	1SNK166012R0000	1	14.00
B (x100)	100	White	MC812PA	1SNK166022R0000	1	14.00
C (x100)	100	White	MC812PA	1SNK166032R0000	1	14.00
D (x100)	100	White	MC812PA	1SNK166042R0000	1	14.00
E (x100)	100	White	MC812PA	1SNK166052R0000	1	14.00
F (x100)	100	White	MC812PA	1SNK166062R0000	1	14.00
G (x100)	100	White	MC812PA	1SNK166072R0000	1	14.00
H (x100)	100	White	MC812PA	1SNK166082R0000	1	14.00
I (x100)	100	White	MC812PA	1SNK166092R0000	1	14.00
J (x100)	100	White	MC812PA	1SNK166102R0000	1	14.00
K (x100)	100	White	MC812PA	1SNK166112R0000	1	14.00
L (x100)	100	White	MC812PA	1SNK166122R0000	1	14.00
M (x100)	100	White	MC812PA	1SNK166132R0000	1	14.00
N (x100)	100	White	MC812PA	1SNK166142R0000	1	14.00
O (x100)	100	White	MC812PA	1SNK166152R0000	1	14.00
P (x100)	100	White	MC812PA	1SNK166162R0000	1	14.00
Q (x100)	100	White	MC812PA	1SNK166172R0000	1	14.00
R (x100)	100	White	MC812PA	1SNK166182R0000	1	14.00
S (x100)	100	White	MC812PA	1SNK166192R0000	1	14.00
T (x100)	100	White	MC812PA	1SNK166202R0000	1	14.00
U (x100)	100	White	MC812PA	1SNK166212R0000	1	14.00
V (x100)	100	White	MC812PA	1SNK166222R0000	1	14.00

Continue on next page →

1SNK160011S0201 - Rev. A

MC812PA terminal block markers

Pre-printed marker card for vertical terminal block assembly



MC812PA



8 mm 0.315 in spacing

Ordering details

Description	Number of markers per card	Color	Type	Part Number	Pkg card	Weight (1 pce) g
← Continuation of previous page						
W (x100)	100	White <input type="checkbox"/>	MC812PA	1SNK166232R0000	1	14.00
X (x100)	100	White <input type="checkbox"/>	MC812PA	1SNK166242R0000	1	14.00
Y (x100)	100	White <input type="checkbox"/>	MC812PA	1SNK166252R0000	1	14.00
Z (x100)	100	White <input type="checkbox"/>	MC812PA	1SNK166262R0000	1	14.00
0 (x100)	100	White <input type="checkbox"/>	MC812PA	1SNK167002R0000	1	14.00
1 (x100)	100	White <input type="checkbox"/>	MC812PA	1SNK167012R0000	1	14.00
2 (x100)	100	White <input type="checkbox"/>	MC812PA	1SNK167022R0000	1	14.00
3 (x100)	100	White <input type="checkbox"/>	MC812PA	1SNK167032R0000	1	14.00
4 (x100)	100	White <input type="checkbox"/>	MC812PA	1SNK167042R0000	1	14.00
5 (x100)	100	White <input type="checkbox"/>	MC812PA	1SNK167052R0000	1	14.00
6 (x100)	100	White <input type="checkbox"/>	MC812PA	1SNK167062R0000	1	14.00
7 (x100)	100	White <input type="checkbox"/>	MC812PA	1SNK167072R0000	1	14.00
8 (x100)	100	White <input type="checkbox"/>	MC812PA	1SNK167082R0000	1	14.00
9 (x100)	100	White <input type="checkbox"/>	MC812PA	1SNK167092R0000	1	14.00
+ (x100)	100	White <input type="checkbox"/>	MC812PA	1SNK168002R0000	1	14.00
- (x100)	100	White <input type="checkbox"/>	MC812PA	1SNK168012R0000	1	14.00
~ (x100)	100	White <input type="checkbox"/>	MC812PA	1SNK168022R0000	1	14.00
= (x100)	100	White <input type="checkbox"/>	MC812PA	1SNK168032R0000	1	14.00
± (x100)	100	White <input type="checkbox"/>	MC812PA	1SNK168042R0000	1	14.00
L1 (x100)	100	White <input type="checkbox"/>	MC812PA	1SNK168052R0000	1	14.00
L2 (x100)	100	White <input type="checkbox"/>	MC812PA	1SNK168062R0000	1	14.00
L3 (x100)	100	White <input type="checkbox"/>	MC812PA	1SNK168072R0000	1	14.00
PE (x100)	100	White <input type="checkbox"/>	MC812PA	1SNK168092R0000	1	14.00
U1 (x100)	100	White <input type="checkbox"/>	MC812PA	1SNK168102R0000	1	14.00
U2 (x100)	100	White <input type="checkbox"/>	MC812PA	1SNK168112R0000	1	14.00
U3 (x100)	100	White <input type="checkbox"/>	MC812PA	1SNK168122R0000	1	14.00
V1 (x100)	100	White <input type="checkbox"/>	MC812PA	1SNK168132R0000	1	14.00
V2 (x100)	100	White <input type="checkbox"/>	MC812PA	1SNK168142R0000	1	14.00
V3 (x100)	100	White <input type="checkbox"/>	MC812PA	1SNK168152R0000	1	14.00
W1 (x100)	100	White <input type="checkbox"/>	MC812PA	1SNK168162R0000	1	14.00
W2 (x100)	100	White <input type="checkbox"/>	MC812PA	1SNK168172R0000	1	14.00
W3 (x100)	100	White <input type="checkbox"/>	MC812PA	1SNK168182R0000	1	14.00
+24V (x100)	100	White <input type="checkbox"/>	MC812PA	1SNK168192R0000	1	14.00
+48V (x100)	100	White <input type="checkbox"/>	MC812PA	1SNK168202R0000	1	14.00
-24V (x100)	100	White <input type="checkbox"/>	MC812PA	1SNK168212R0000	1	14.00
-48V (x100)	100	White <input type="checkbox"/>	MC812PA	1SNK168222R0000	1	14.00
L1-L2-L3-N-PE (x20)	100	White <input type="checkbox"/>	MC812PA	1SNK169002R0000	1	14.00
U1-U2-U3-V1-V2-V3-W1-W2-W3 (x10) + U1 (x10)	100	White <input type="checkbox"/>	MC812PA	1SNK169012R0000	1	14.00

UMH universal wire markers holder - MG2-TDMO clip-on blank wire marker

Markers and marking systems



5.2 mm 0.205 in spacing

Mounting instructions



Install the UMH on the terminal blocks (strip mounting) and slide on the wire markers.

UMH universal wire markers holder

Description

- Compatible with MG2 - TDMO wire markers and most of the wire markers available on the market (wire markers not supplied with UMH);
- Quickly put it on any SNK terminal blocks and accessories: strip mounting of 10 parts for 5.2 mm 0.205 in spacing, unitary mounting for other spacings.

Ordering details

Description	Color	Type	Part Number	Pkg qty	Weight (1 pce) g
5.2 mm 0.205 in spacing	Grey <input type="checkbox"/>	UMH	1SNK900611R0000	10	0.20

Main technical data

Material specifications	Insulating material	Polyamide		
	Flammability	V0		
	NF F 16 101	I2F2		
Ambient temperature min/max	Service IEC 60068-2-1	-55 ... +110 °C	-67 ... +230 °F	
	Storage	-55 ... +110 °C	-67 ... +230 °F	
	Installing	-5 ... +40 °C	-23 ... +104 °F	

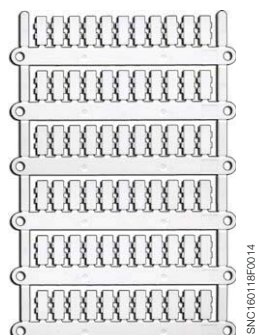

MG2-TDMO

MG2-TDMO clip-on blank wire marker

Description

- Rigid Polycarbonate marker to be directly printed and snapped on the wire or the UMH wire marker holder,
- Print with support plate MG2-PTM.

Main technical data

Material	Flammability	Temperature range
PC	V0	-40°C ... +140°C, - 22°F ... +176°F

Ordering details

Dimensions mm in	Number of markers per card	Color	Type	Part Number	SW code	Pkg qty	Weight (1 pce) g
MG2-TDMO-01							
4 x 12 0.157 x 0.472	40	White <input type="checkbox"/>	MG2-TDMO-01 40390	1SNB040390R0412	125	880	0.30
4 x 16 0.157 x 0.630	40	White <input type="checkbox"/>	MG2-TDMO-01 40391	1SNB040391R0416	128	880	0.30
4 x 12 0.157 x 0.472	40	Yellow <input checked="" type="checkbox"/>	MG2-TDMO-01 40340	1SNB040340R0412	125	800	0.30
4 x 16 0.157 x 0.630	40	Yellow <input checked="" type="checkbox"/>	MG2-TDMO-01 40341	1SNB040341R0416	128	800	0.30
MG2-TDMO-02							
4 x 12 0.157 x 0.472	40	White <input type="checkbox"/>	MG2-TDMO-02 40490	1SNB040490R0412	126	640	0.40
4 x 16 0.157 x 0.630	40	White <input type="checkbox"/>	MG2-TDMO-02 40491	1SNB040491R0416	129	640	0.40
4 x 12 0.157 x 0.472	40	Yellow <input checked="" type="checkbox"/>	MG2-TDMO-02 40440	1SNB040440R0412	126	640	0.40
4 x 16 0.157 x 0.630	40	Yellow <input checked="" type="checkbox"/>	MG2-TDMO-02 40441	1SNB040441R0416	129	640	0.40
MG2-TDMO-03							
4 x 12 0.157 x 0.472	40	White <input type="checkbox"/>	MG2-TDMO-03 40590	1SNB040590R0412	127	560	0.40
4 x 16 0.157 x 0.630	40	White <input type="checkbox"/>	MG2-TDMO-03 40591	1SNB040591R0416	130	560	0.40
4 x 12 0.157 x 0.472	40	Yellow <input checked="" type="checkbox"/>	MG2-TDMO-03 40540	1SNB040540R0412	127	560	0.40
4 x 16 0.157 x 0.630	40	Yellow <input checked="" type="checkbox"/>	MG2-TDMO-03 40541	1SNB040541R0416	130	560	0.40

Marking system

MG3 KIT <input checked="" type="checkbox"/>	AMS 250	AMS 600	HTP500
---	---------	---------	--------

Description	Support status	Type	Part Number	Pkg qty	Weight (1 pce) g
Support plate					
Support plate for cable tags MG2-TDMO & MG-TDM 4x16mm	Purchased separately	MG2-PTM 991010	1SNB991010R0000	1	116.00



MG3 KIT

Markers for components

Markers and marking systems

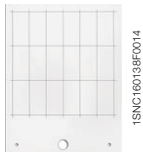

MG-TAR

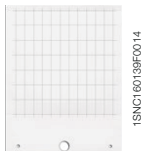
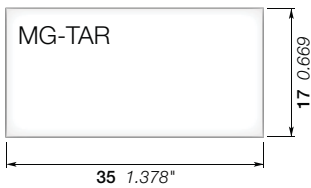
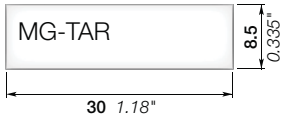

MG-TAA

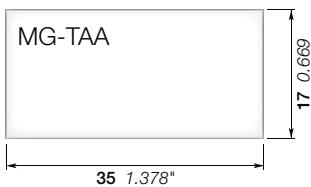
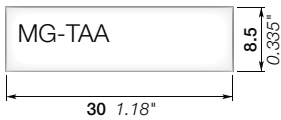

MG-TAR markers for components

Description

Identify your terminal blocks assembly with the pre-cut blank label adapted to the LH label holders.

Ordering details

Description	Nb. of markers per card	Nb. of card by package	Color	Type	Part Number	SW code	Pkg	Weight
For LH label holder	33	50	White <input type="checkbox"/>	MG-TAR 45490	1SNB045490R8530	720	marker	1 marker g
For LH-R1 label holder	18	50		MG-TAR 45194	1SNB045194R1735	711		900 0.628

Main technical data

Material specifications	Insulating material	Rigid PVC					
	Flammability	V0					
	NF F 16 101						
Ambient temperature min/max	Service IEC 60068-2-1	-30 ... +80 °C	-22 ... +176 °F				
	Storage	-30 ... +80 °C	-22 ... +176 °F				
	Installing	+10 ... +40 °C	+50 ... +104 °F				

MG-TAA markers for components

Description

Identify your terminal blocks assembly with the self adhesive label adapted to the LH label holders.

Ordering details

Description	Nb. of markers per card	Nb. of card by package	Color	Type	Part Number	SW code	Pkg	Weight
For LH label holder	33	25	White <input type="checkbox"/>	MG-TAA 49498	1SNB049498R8530	33	825	0.55
	33	25	Yellow <input type="checkbox"/>	MG-TAA 49448	1SNB049448R8530	33	825	0.55
For LH-R1 label holder	18	25	White <input type="checkbox"/>	MG-TAA 49198	1SNB049198R1735	711	450	0.91
	18	25	Yellow <input type="checkbox"/>	MG-TAA 49148	1SNB049148R1735	711	450	0.91

Main technical data

Material specifications	Insulating material	Rigid PVC					
	Flammability	V0					
	NF F 16 101						
Ambient temperature min/max	Service IEC 60068-2-1	-30 ... +80 °C	-22 ... +176 °F				
	Storage	-30 ... +80 °C	-22 ... +176 °F				
	Installing	+10 ... +40 °C	+50 ... +104 °F				

Marking system & accessories

Description	Color	Type	Part Number	Pkg	Weight
Thermal transfer printer	Grey <input type="checkbox"/>	MG3 KIT	1SNB419001R0000	1 qty	12600 (1 pce) g



Markers for components

Markers and marking systems



MG-TAPW

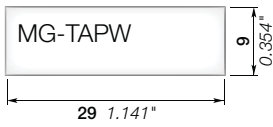

MG-TAPW markers for components

Description

Identify your terminal blocks assembly with the precut blank label adapted to the LH label holders.

Ordering details

Description	Nb. of markers per card	Nb. of card by package	Color	Type	Part Number	SW code	Pkg marker	Weight 1 marker g
For LH label holder	30	50	White <input type="checkbox"/>	MG-TAPW 49096	1SNB049096R0929	363	1500	0.30
	30	50	Yellow <input type="checkbox"/>	MG-TAPW 49046	1SNB049046R0929	363	1500	0.30

Main technical data

Material specifications	Insulating material	Rigid PVC				
	Flammability	V0				
Ambient temperature min/max	NF F 16 101					
	Service IEC 60068-2-1	-30 ... +80 °C	-22 ... +176 °F			
	Storage	-30 ... +80 °C	-22 ... +176 °F			
	Installing	+10 ... +40 °C	+50 ... +104 °F			



Marking system & accessories

Description	Color	Type	Part Number	Pkg qty	Weight (1 pce) g
Thermal transfer printer	Grey <input type="checkbox"/>	MG3 KIT	1SNB419001R0000	1	12600

1SNK160100S0201

Label

Markers and marking systems

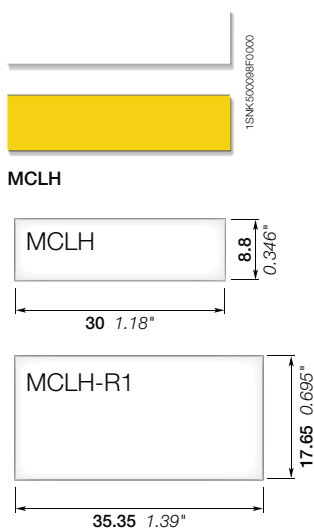

MCLH label

Description

Identify your terminal blocks assembly with the self adhesive label adapted to the LH label holders.

Ordering details

Description	Nb. of markers per card	Nb. of card by package	Color	Type	Part Number	SW code	Pkg	Weight
For LH label holder	36	25	White <input type="checkbox"/>	MCLH	1SNK900630R0000		card	1 card g
			Yellow <input checked="" type="checkbox"/>	MCLH-YL	1SNK900633R0000		25	10.00
For LH-R1 label holder	15	25	White <input type="checkbox"/>	MCLH-R1	1SNK900631R0000		25	10.00
			Yellow <input checked="" type="checkbox"/>	MCLH-R1-YL	1SNK900634R0000		25	10.00

Main technical data

Material specifications	Insulating material	PVC + adhesive acrylic				
	Flammability	V0				
	NF F 16 101					
Ambient temperature min/max	Service IEC 60068-2-1	-55 ... +110 °C	-67 ... +230 °F			
	Storage	-55 ... +110 °C	-67 ... +230 °F			
	Installing	-5 ... +40 °C	+23 ... +104 °F			

Marking system & accessories

Description	Color	Type	Part Number	Pkg	Weight
1 Plotter		AMS 600 KIT	1SNA360000R2400	1	12600.00
2 Support plate for AMS		SPRC 21	1SNA360031R0600	1	851.00

Complete list of accessories is indicated in the terminal block datasheet including end stops.

Some accessories such as jumper bars may modify the terminal block's ratings: Complete information available in the accessories section of the catalog.

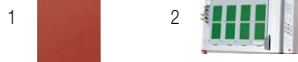

HTP500 thermal transfer printer

Consumables



HTP500-CLEAN



HTP500-FEED



HTP500-PL2



RIB-B

Feeders and support plates

Description	Color	Type	Part Number	Pkg qty	Weight (1 pce) g
Universal feeder for marker cards		HTP500-FEED	1SNA235703R0400	1	
Support plate for TE Connectivity terminal block markers		HTP500-PL2	1SNA235705R0600	1	
Universal support plate for wire markers		HTP500-PL	1SNA235704R0500	1	

Accessories

Description	Color	Type	Part Number	Pkg qty	Weight (1 pce) g
Black ribbon cassette		RIB-B	1SNA235710R0600	3	
Red ribbon cassette for identification plates and adhesive labels		RIB-R	1SNA235711R2300	3	
Red ribbon cassette for terminal blocks and wire markers		RIB-RS	1SNA235718R0200	3	
Cleaning cassette		HTP500-CLEAN	1SNA235714R2600	1	
Standard cleaning roll ø18		HTP500-ROLL	1SNA235715R2700	1	
Printing head		HTP500-PRINT	1SNA235716R2000	1	
Dust cover for HTP500 and AMS 600 systems		DUST COVER	1SNA360161R1500	1	
Wooden box for HTP500-V2 KIT		HTP500-WB	1SNA235717R2100	1	
Software CD		HTS500	1SNA235702R0300	1	
Support table		HTP500-BAS	1SNA235706R0700	1	
Power supply cable		HTP500-PW	1SNA235709R1200	1	

MG3 thermal transfer printer

Kit and accessories



MG3 KIT

Description

- Versatile,
- Compact and robust,
- Easy to install and use.

Ordering details

Description	Color	Type	Part Number	Pkg pce	Weight (1 pce) g
MG3 Thermal transfer printer KIT		MG3 KIT	1SNB419001R0000	1	12600.00
List of items included in the KIT:					
1 MG3 Thermal transfer printer		MG3			
1 Software CD		MG3 SOFTWARE			
1 Power supply cable		MG3 POWER			
1 USB cable		MG3 USB			
1 Protective cover		MG2 COVE 991680			
1 Ribbon take up spool		MG2-CRB 991654			
1 Black monochrome ribbon		MG2-ETR 991600			
1 Support plate for cable tags MG-TPM		MG2-PWC 991000			
1 Support plate for labels, cables, plates and various markers		MG2-PLT 991002			
1 Support plate for terminal block markers MG-CPM-01(5x10 and 5x15),02,03,04,07		MG2-QTB 991011			
1 Support plate for SNK series terminal block markers (MG-CPM-13)		MG2-ETB 991016			



Support plate MG2-...

Support plates

Description	Color	Type	Part Number	Pkg pce	Weight (1 pce) g
Support template for:					
Cable tags MG-TPM		MG2-PWC 991000	1SNB991000R0000	1	148.00
Labels, cable tags, plates and various markers		MG2-PLT 991002	1SNB991002R0000	1	148.00
Terminal block markers MG-CPM-05,12		MG2-WTB 991004	1SNB991004R0000	1	151.00
Terminal block markers MG-CPM-06		MG2-STB 991005	1SNB991005R0000	1	158.00
Terminal block markers MG-CPM-10		MG2-CTB 991006	1SNB991006R0000	1	156.00
Cable tags MG-TDM (4x12 mm)		MG2-PTD 991007	1SNB991007R0000	1	126.00
Terminal block markers MG-CPM-01 (5x7 mm)		MG2-MTB 991008	1SNB991008R0000	1	149.00
Cable tags MG2-TDMO and MG-TDM (4x16 mm)		MG2-PTM 991010	1SNB991010R0000	1	116.00
Terminal block markers MG-CPM-01 (5x10 and 5x15 mm),02,03,04,07		MG2-QTB 991011	1SNB991011R0000	1	120.00
Terminal block markers TE Connectivity RC and MC series		MG2-ABM 991012	1SNB991012R0000	1	146.00
Terminal block markers MG-CPM-09		MG2-LTB 991013	1SNB991013R0000	1	128.00
Terminal block markers SNK series MG-CPM-13		MG2-ETB 991016	1SNB991016R0000	1	100.00

PET blank cover for support plate

Description	Color	Type	Part Number	Pkg pce	Weight (1 pce) g
PET blank for support plate MG2-PWC		MG2-TWC 991502	1SNB991502R0000	3	16.70
PET blank for support plate MG2-PLT		MG2-TLT 991522	1SNB991522R0000	3	14.70
PET blank for support plate MG2-PTD		MG2-TTD 991563	1SNB991563R0000	3	11.70
PET blank for support plate MG2-MTB		MG2-TMT 991513	1SNB991513R0000	3	12.00
PET blank for support plate MG2-WTB		MG2-TWT 991542	1SNB991542R0000	3	12.00
PET blank for support plate MG2-STB		MG2-TST 991552	1SNB991552R0000	3	21.50
PET blank for support plate MG2-CTB		MG2-TCT 991562	1SNB991562R0000	3	12.00
PET blank for support plate MG2-QTB		MG2-TGT 991532	1SNB991532R0000	3	11.70
PET blank for support plate MG2-ETB		MG2-TTB 991512	1SNB991512R0000	3	10.70



Ribbons MG2-ETR...

Accessories

Description	Color	Type	Part Number	Pkg pce	Weight (1 pce) g
Print head cleaning kit		MG2-CKP 991670	1SNB991670R0000	1	336.00
Black monochrome ribbon	Black ■	MG2-ETR 991600	1SNB991600R0000	1	227.00
Blue monochrome ribbon	Blue ■	MG2-ETR 991601	1SNB991601R0000	1	229.00
Red monochrome ribbon	Red ■	MG2-ETR 991602	1SNB991602R0000	1	255.00
Green monochrome ribbon	Green ■	MG2-ETR 991603	1SNB991603R0000	1	247.00
White monochrome ribbon	White □	MG2-ETR 991606	1SNB991606R0000	1	333.00

AMS plotter

Kit and accessories



AMS 600

AMS 600

Description

- For basic marking applications,
- Economic,
- Full-size format,
- Print original manufacturers' markers.

Ordering details

Description	Color	Type	Part Number	Pkg pce	Weight (1 pce) g
AMS 600 Plotter KIT		AMS 600 KIT	1SNA360000R2400	1	12600
List of items included in the KIT:					
1 AMS 600 plotter pen printer		AMS 600			
1 Software CD		AMS SOFTWARE			
1 Power supply cable		AMS POWER			
1 USB cable		AMS USB			
1 Support plate for RC / MC / RCTT / WMTT / BA4 / RCT		SPRC1			
1 Support plate for MC...PA		SPRC 30-3			
1 Plotter pen Ø 0.25 mm .01 in		AMS PEN 0.25			
1 Plotter pen Ø 0.35 mm .014 in		AMS PEN 0.35			
5 Ink cartridges		AMS INK CARTRIDGES			
1 Cleaner fluid		AMS CLEANER FLUID			
1 Cleaner kit		AMS CLEANER KIT			



AMS 250

AMS 250

Description

- Basic needs,
- Economic,
- Half-size format
- Compatible with most of AMS 600 accessories.

Ordering details

Description	Color	Type	Part Number	Pkg pce	Weight (1 pce) g
AMS 250 Plotter KIT		AMS 250 BASIC KIT	1SNA360000R2500	1	8800
List of items included in the KIT:					
1 AMS 250 plotter pen printer		AMS 250 BASIC			
1 Software CD		AMS SOFTWARE			
1 Power supply cable		AMS POWER			
1 USB cable		AMS USB			
1 Support plate for BA4 / MC / RC / RCAL / RCT / RCTT		SPRC2			
1 Disposable plotter pen Ø 0.25 mm .01 in EDR ink		DISPOSABLE AMS PEN ED-R 0.25			
1 Disposable plotter pen Ø 0.35 mm .014 in EDR ink		DISPOSABLE AMS PEN ED-R 0.35			

AMS plotter Kit and accessories

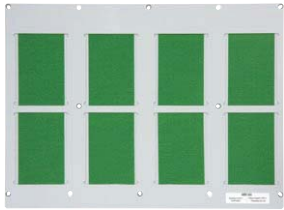

SPRC1

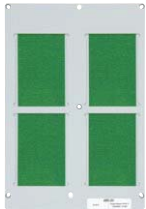

SPRC2



SPRC30-3

Support plates for TE Connectivity markers

Description	Compatibility		Type	Part Number	Pkg pce	Weight (1 pce) g
	AMS 500 AMS 600	AMS 250				
Support plates for:						
RC/MC/RCTT/WMTT/BA4/RCT full format	●		SPRC 1	1SNA360010R1500	1	1500.00
RC/MC/RCTT/WMTT/BA4/RCT		●	SPRC 2	1SNA360011R1500	1	600.00
RB strips	●	●	SPRC 4	1SNA360014R0500	1	300.00
RTM7-9	●		SPRC 5	1SNA360015R0600	1	1700.00
PIB	●	●	SPRC 13	1SNA360023R0600	1	260.00
BA5-50	●	●	SPRC 14	1SNA360024R0700	1	300.00
RC-X10A	●	●	SPRC 15	1SNA360025R0000	1	300.00
2 RC cards	●	●	SPRC 16	1SNA360026R0100	1	300.00
WM markers	●	●	SPRC 26	1SNA360036R0300	1	300.00
PAM strip	●	●	SPRC 27	1SNA360037R0400	1	300.00
RPCV markers	●	●	SPRC 28	1SNA360040R2300	1	300.00
RCL P. W510	●	●	SPRC 29	1SNA360038R1500	1	300.00
MC... PA	●	●	SPRC 30-3	1SNA360039R1700	1	500.00
A4 universal support plate	●	●	SPRC 21	1SNA360031R0600	1	500.00

Support plates for other manufacturers

Description	Compatibility		Type	Part Number	Pkg pce	Weight (1 pce) g
	AMS 500 AMS 600	AMS 250				
Support plates for markers:						
Wieland	●	●	SPRC 6	1SNA360016R0700	1	350.00
Weidmüller	●	●	SPRC 7	1SNA360017R0000	1	400.00
Phoenix ZBM 5/6	●	●	SPRC 8	1SNA360018R1100	1	300.00
Phoenix ZB	●	●	SPRC 9	1SNA360019R1200	1	300.00
Allen Bradley WRZ	●	●	SPRC 10	1SNA360020R1700	1	330.00
Wago mini WSB5	●	●	SPRC 11	1SNA360021R0400	1	300.00

Accessories

Description	Diameter Color	Type	Part Number	Pkg pce	Weight (1 pce) g	
Plotter pen P 2.0 black ink	Ø 0.18 mm 0.007 in	Red ■	AMS PEN 0.18	1SNA360103R1400	1	15.00
	Ø 0.25 mm 0.01 in	White □	AMS PEN 0.25	1SNA360100R2500	1	15.00
	Ø 0.35 mm 0.014 in	Yellow ■	AMS PEN 0.35	1SNA360101R1200	1	15.00
	Ø 0.50 mm 0.02 in	Brown ■	AMS PEN 0.50	1SNA360104R1500	1	26.00
	Ø 0.70 mm 0.028 in	Blue ■	AMS PEN 0.70	1SNA360105R1600	1	26.00
	Ø 1.00 mm 0.039 in	Orange ■	AMS PEN 1.00	1SNA360106R1700	1	26.00
Disposable plotter pen P 2.0 black ink	Ø 0.25 mm 0.01 in	White □	DISPOSABLE AMS PEN 0.25	1SNA360120R1000	1	24.00
	Ø 0.35 mm 0.014 in	Yellow ■	DISPOSABLE AMS PEN 0.35	1SNA360121R0500	1	24.00
Disposable plotter pen ED-R black ink	Ø 0.18 mm 0.007 in	Red ■	DISPOSABLE AMS PEN ED-R 0.18	1SNA360124R1000	1	24.00
	Ø 0.25 mm 0.01 in	White □	DISPOSABLE AMS PEN ED-R 0.25	1SNA360122R1000	1	24.00
	Ø 0.35 mm 0.014 in	Yellow ■	DISPOSABLE AMS PEN ED-R 0.35	1SNA360123R0500	1	24.00
5 ink cartridges 1 ml		AMS INK CARTRIDGES	1SNA360150R2600	1	18.00	
2 cleaner fluid bottles, 2x10 ml		AMS CLEANER FLUID	1SNA360155R1700	1	40.00	
Cleaner kit including: 1 rinse bottle and 1 blotting paper		AMS CLEANER KIT	1SNA360156R1000	1	34.00	
Dust cover		DUST COVER	1SNA360161R1500	1	200.00	
Service kit for pen maintenance		SERVICE KIT FOR AMS 600	1SNA360162R1600	1	12.00	
Self-adhesive support for support plate SPRC 1		SPDST1	1SNA360163R1700	1	70.00	
Plotter head for AMS 600 including 1 printing module, 1 pen holder and 1 dust cover		PEN HOLDER	1SNA360098R1200	1	85.00	



AMS PEN



AMS CLEANER KIT

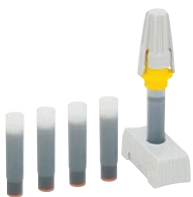

AMS INK CARTRIDGES



Index

Part Number classification

Part Number	Type	Page	Part Number	Type	Page	Part Number	Type	Page
1SNK905303R0000	JB5-3	21						
1SNK905304R0000	JB5-4	21						
1SNK905305R0000	JB5-5	21						
1SNK905310R0000	JB5-10	21						
1SNK905350R0000	JB5-50	21						
1SNK906302R0000	JB6-2	24						
1SNK906303R0000	JB6-3	24						
1SNK906304R0000	JB6-4	24						
1SNK906305R0000	JB6-5	24						
1SNK906310R0000	JB6-10	24						
1SNK906350R0000	JB6-50	24						
1SNK908302R0000	JB8-2	27						
1SNK908303R0000	JB8-3	27						
1SNK908304R0000	JB8-4	27						
1SNK908305R0000	JB8-5	27						
1SNK908310R0000	JB8-10	27						
1SNK908902R0000	JB8-2-R1	154						
1SNK908903R0000	JB8-3-R1	154						
1SNK908904R0000	JB8-4-R1	154						
1SNK908905R0000	JB8-5-R1	154						
1SNK908910R0000	JB8-10-R1	154						
1SNK910302R0000	JB10-2	29						
1SNK910303R0000	JB10-3	29						
1SNK910304R0000	JB10-4	29						
1SNK910305R0000	JB10-5	29						
1SNK910310R0000	JB10-10	29						
1SNK912302R0000	JB12-2	30						
1SNK912303R0000	JB12-3	30						
1SNK912305R0000	JB12-5	30						
1SNK916302R0000	JB16-2	87						
1SNK916303R0000	JB16-3	87						
1SNK916304R0000	JB16-4	87						
1SNK916305R0000	JB16-5	87						
1SNK916310R0000	JB16-10	87						
1SNK922302R0000	JB22-2	89						
1SNK922303R0000	JB22-3	89						
1SNK922305R0000	JB22-5	89						
1SNK922310R0000	JB22-10	89						
1SNK926302R0000	JB26-2	90						
1SNK926303R0000	JB26-3	90						
1SNK926305R0000	JB26-5	90						
1SNK926310R0000	JB26-10	90						

Index

Type classification

Type	Part Number	Page	Type	Part Number	Page	Type	Part Number	Page
AJS9	1SNA179726R0200	152	ES4-T3	1SNK505961R0000	146	1SNK140122R0000	248	
AJS9-BK	1SNA206680R1500	154	ES6-3S	1SNK505912R0000	82	1SNK140131R0000	246	
AJS9-BL	1SNA206683R0400	154	ES6-4S	1SNK50591R0000	83	1SNK140132R0000	248	
AJS9-BR	1SNA206782R0000	154	ES-TC6	1SNK900105R0000	24	1SNK140141R0000	246	
AJS9-GN	1SNA206681R0200	154	ES-TC8	1SNK900104R0000	27	1SNK140142R0000	248	
AJS9-GR	1SNA206682R0300	154	HTP500-BAS	1SNA235706R0700	265	1SNK140151R0000	246	
AJS9-PR	1SNA206772R0000	154	HTP500-CLEAN	1SNA235714R2600	265	1SNK140152R0000	248	
AJS9-RD	1SNA206720R1400	154	HTP500-FEED	1SNA235703R0400	265	1SNK140161R0000	246	
AJS9-WH	1SNA206765R0000	154	HTP500-PL	1SNA235704R0500	265	1SNK140162R0000	248	
AL4-M3	1SNA206721R0100	152	HTP500-PL2	1SNA235705R0600	265	1SNK140171R0000	246	
AMS 250 BASIC KIT	1SNA360000R2500	267	HTP500-PRINT	1SNA235716R2000	265	1SNK140172R0000	248	
AMS 600 KIT	1SNA360000R2400	245	HTP500-PW	1SNA235709R1200	265	1SNK140181R0000	246	
AMS CLEANER FLUID	1SNA360155R1700	268	HTP500-ROLL	1SNA235715R2700	265	1SNK140182R0000	248	
AMS CLEANER KIT	1SNA360156R1000	268	HTP500-WB	1SNA235717R2100	265	1SNK140191R0000	246	
AMS INK CARTRIDGES	1SNA360150R2600	268	HTS500	1SNA235702R0300	265	1SNK140192R0000	248	
AMS PEN 0.18	1SNA360103R1400	268	JB10-10	1SNK910310R0000	29	1SNK140201R0000	246	
AMS PEN 0.25	1SNA360100R2500	268	JB10-2	1SNK910302R0000	29	1SNK140202R0000	248	
AMS PEN 0.35	1SNA360101R1200	268	JB10-3	1SNK910303R0000	29	1SNK145011R0000	246	
AMS PEN 0.50	1SNA360104R1500	268	JB10-4	1SNK910304R0000	29	1SNK145012R0000	248	
AMS PEN 0.70	1SNA360105R1600	268	JB10-5	1SNK910305R0000	29	1SNK145021R0000	246	
AMS PEN 1.00	1SNA360106R1700	268	JB12-2	1SNK912302R0000	30	1SNK145022R0000	248	
ANT	1SNA168675R1400	120	JB12-3	1SNK912303R0000	30	1SNK145031R0000	246	
BAM4	1SNK900001R0000	80	JB12-5	1SNK912305R0000	30	1SNK145032R0000	248	
BAZ1	1SNK900002R0000	30	JB16-10	1SNK916310R0000	87	1SNK145041R0000	246	
BAZH1	1SNK900102R0000	56	JB16-2	1SNK916302R0000	87	1SNK145042R0000	248	
BJM131.2	1SNA206053R0700	91	JB16-3	1SNK916303R0000	87	1SNK145051R0000	246	
BJM131.3	1SNA206054R0000	91	JB16-4	1SNK916304R0000	87	1SNK145052R0000	248	
BJM136.2	1SNA206126R2500	92	JB16-5	1SNK916305R0000	87	1SNK145061R0000	246	
BJM136.3	1SNA206223R0600	92	JB22-10	1SNK922310R0000	89	1SNK145062R0000	248	
CDK2.5	1SNK805712R0000	172	JB22-2	1SNK922302R0000	89	1SNK145071R0000	246	
CDK2.5-2P-J	1SNK805740R0000	187	JB22-3	1SNK922303R0000	89	1SNK145072R0000	248	
CDK2.5-2P-J-BL	1SNK805746R0000	187	JB22-5	1SNK922305R0000	89	1SNK145081R0000	246	
CDK2.5-2P-J-BL-E	1SNK805747R0000	187	JB26-10	1SNK926310R0000	90	1SNK145082R0000	248	
CDK2.5-2P-J-E	1SNK805741R0000	187	JB26-2	1SNK926302R0000	90	1SNK145091R0000	246	
CDK2.5-2P-J-PE	1SNK805751R0000	187	JB26-3	1SNK926303R0000	90	1SNK145092R0000	248	
CDK2.5-2P-J-PE-E	1SNK805752R0000	187	JB26-5	1SNK926305R0000	90	1SNK145102R0000	246	
CDK2.5-BL	1SNK805742R0000	175	JB5-10	1SNK905310R0000	21	1SNK146011R0000	246	
CDK2.5-BL-E	1SNK805743R0000	175	JB5-2	1SNK905302R0000	21	1SNK146012R0000	248	
CDK2.5-E	1SNK805713R0000	172	JB5-3	1SNK905303R0000	21	1SNK146021R0000	246	
CDK2.5-J	1SNK805738R0000	186	JB5-4	1SNK905304R0000	21	1SNK146022R0000	248	
CDK2.5-J-BL	1SNK805744R0000	186	JB5-5	1SNK905305R0000	21	1SNK146031R0000	246	
CDK2.5-J-BL-E	1SNK805745R0000	186	JB5-50	1SNK905350R0000	21	1SNK146032R0000	248	
CDK2.5-J-E	1SNK805739R0000	186	JB6-10	1SNK906310R0000	24	1SNK146041R0000	246	
CDK2.5-J-PE	1SNK805748R0000	186	JB6-2	1SNK906302R0000	24	1SNK146042R0000	248	
CDK2.5-J-PE-E	1SNK805749R0000	186	JB6-3	1SNK906303R0000	24	1SNK146051R0000	246	
CDK2.5-PE	1SNK805750R0000	174	JB6-4	1SNK906304R0000	24	1SNK146052R0000	248	
CDK2.5-PE-E	1SNK805753R0000	174	JB6-5	1SNK906305R0000	24	1SNK146061R0000	246	
CDK4	1SNK806712R0000	178	JB6-50	1SNK906350R0000	24	1SNK146062R0000	248	
CDK4-E	1SNK806713R0000	178	JB8-10	1SNK908310R0000	27	1SNK146071R0000	246	
CDS4	1SNK805714R0000	190	JB8-10-R1	1SNK908910R0000	154	1SNK146072R0000	248	
CDS4-E	1SNK805715R0000	190	JB8-2	1SNK908302R0000	27	1SNK146081R0000	246	
CDS4-R1	1SNK806714R0000	192	JB8-2-R1	1SNK908902R0000	154	1SNK146082R0000	248	
CN5	1SNA179371R1600	120	JB8-3	1SNK908303R0000	27	1SNK146091R0000	246	
CO	1SNK900604R0000	155	JB8-3-R1	1SNK908903R0000	154	1SNK146092R0000	248	
COP-ZD	1SNK900636R0000	172	JB8-4	1SNK908304R0000	27	1SNK146101R0000	246	
CPBP1	1SNA399788R1600	91	JB8-4-R1	1SNK908904R0000	154	1SNK146102R0000	248	
CPBP2	1SNA399787R0500	92	JB8-5	1SNK908305R0000	27	1SNK146111R0000	246	
CS	1SNK900101R0000	80	JB85-3	1SNK900603R0000	21	1SNK146112R0000	248	
CS-R1	1SNK900103R0000	80	JB8-5-R1	1SNK908905R0000	154	1SNK146121R0000	246	
CS-R2	1SNK900106R0000	21	KCO	1SNK900624R0000	155	1SNK146122R0000	248	
CS-R3	1SNK900107R0000	30	LH	1SNK900605R0000	199	1SNK146131R0000	246	
DISPOSABLE AMS PEN 0.25	1SNA360120R1000	268	LH-J	1SNK900606R0000	56	1SNK146132R0000	248	
DISPOSABLE AMS PEN 0.35	1SNA360121R0500	268	LH-R1	1SNK900607R0000	199	1SNK146141R0000	246	
DISPOSABLE AMS PEN ED-R 0.18	1SNA360124R1000	268	MC512	1SNK140000R0000	21	1SNK146142R0000	248	
DISPOSABLE AMS PEN ED-R 0.25	1SNA360122R1000	268	MC512PA	1SNK140011R0000	246	1SNK146151R0000	246	
DISPOSABLE AMS PEN ED-R 0.35	1SNA360123R0500	268		1SNK140012R0000	248	1SNK146152R0000	248	
DUST COVER	1SNA360161R1500	265		1SNK140021R0000	246	1SNK146161R0000	246	
ED2.5-22	1SNK805917R0000	173		1SNK140022R0000	248	1SNK146162R0000	248	
EDK2.5-11	1SNK805915R0000	172		1SNK140031R0000	246	1SNK146171R0000	246	
EDK2.5-21	1SNK805914R0000	176		1SNK140032R0000	248	1SNK146172R0000	248	
EDK2.5-22	1SNK805910R0000	177		1SNK140041R0000	246	1SNK146181R0000	246	
EDK2.5-D	1SNK805913R0000	181		1SNK140042R0000	248	1SNK146182R0000	248	
EDS4-22	1SNK805911R0000	190		1SNK140051R0000	246	1SNK146191R0000	246	
EK10	1SNK710910R0000	29		1SNK140052R0000	248	1SNK146192R0000	248	
EK10-3P	1SNK710911R0000	31		1SNK140061R0000	246	1SNK146201R0000	246	
EK2.5	1SNK705910R0000	21		1SNK140062R0000	248	1SNK146202R0000	248	
EK2.5-3P	1SNK705911R0000	22		1SNK140071R0000	246	1SNK146211R0000	246	
EK2.5-4P	1SNK705912R0000	23		1SNK140072R0000	248	1SNK146212R0000	248	
EK2.5-D2	1SNK705960R0000	56		1SNK140081R0000	246	1SNK146221R0000	246	
EK2.5-S-4P	1SNK705913R0000	50		1SNK140082R0000	248	1SNK146222R0000	248	
EK2.5-T3	1SNK705961R0000	60		1SNK140083R0000	246	1SNK146231R0000	246	
EK6-3P	1SNK708911R0000	28		1SNK140084R0000	248	1SNK146232R0000	249	
EPR1	1SNA178431R2200	201		1SNK140091R0000	246	1SNK146241R0000	246	
EPR2	1SNA399726R0700	201		1SNK140092R0000	248	1SNK146242R0000	249	
ES10-ST	1SNK508910R0000	152		1SNK140101R0000	246	1SNK146251R0000	246	
ES4	1SNK505910R0000	80		1SNK140102R0000	248	1SNK146252R0000	249	
ES4-D2	1SNK505960R0000	136		1SNK140111R0000	246	1SNK146261R0000	247	
ES4-D2-SF1	1SNK508911R0000	144		1SNK140112R0000	248	1SNK146262R0000	249	
ES4-SF	1SNK508960R0000	120		1SNK140121R0000	246	1SNK147001R0000	247	

Index

Type classification

Type	Part Number	Page	Type	Part Number	Page	Type	Part Number	Page
	1SNK147002R0000	249		1SNK150112R0000	254		1SNK156262R0000	255
	1SNK147011R0000	247		1SNK150121R0000	252		1SNK157001R0000	253
	1SNK147012R0000	249		1SNK150122R0000	254		1SNK157002R0000	255
	1SNK147021R0000	247		1SNK150131R0000	252		1SNK157011R0000	253
	1SNK147022R0000	249		1SNK150132R0000	254		1SNK157012R0000	255
	1SNK147031R0000	247		1SNK150141R0000	252		1SNK157021R0000	253
	1SNK147032R0000	249		1SNK150142R0000	254		1SNK157022R0000	255
	1SNK147041R0000	247		1SNK150151R0000	252		1SNK157031R0000	253
	1SNK147042R0000	249		1SNK150152R0000	254		1SNK157032R0000	255
	1SNK147051R0000	247		1SNK150161R0000	252		1SNK157041R0000	253
	1SNK147052R0000	249		1SNK150162R0000	254		1SNK157042R0000	255
	1SNK147061R0000	247		1SNK150171R0000	252		1SNK157051R0000	253
	1SNK147062R0000	249		1SNK150172R0000	254		1SNK157052R0000	255
	1SNK147071R0000	247		1SNK150181R0000	252		1SNK157061R0000	253
	1SNK147072R0000	249		1SNK150182R0000	254		1SNK157062R0000	255
	1SNK147081R0000	247		1SNK150191R0000	252		1SNK157071R0000	253
	1SNK147082R0000	249		1SNK150192R0000	254		1SNK157072R0000	255
	1SNK147091R0000	247		1SNK150201R0000	252		1SNK157081R0000	253
	1SNK147092R0000	249		1SNK150202R0000	254		1SNK157082R0000	255
	1SNK148001R0000	247		1SNK155011R0000	252		1SNK157091R0000	253
	1SNK148002R0000	249		1SNK155012R0000	254		1SNK157092R0000	255
	1SNK148011R0000	247		1SNK155021R0000	252		1SNK158001R0000	253
	1SNK148012R0000	249		1SNK155022R0000	254		1SNK158002R0000	255
	1SNK148021R0000	247		1SNK155031R0000	252		1SNK158011R0000	253
	1SNK148022R0000	249		1SNK155032R0000	254		1SNK158012R0000	255
	1SNK148031R0000	247		1SNK155041R0000	252		1SNK158021R0000	253
	1SNK148032R0000	249		1SNK155042R0000	254		1SNK158022R0000	255
	1SNK148041R0000	247		1SNK155051R0000	252		1SNK158031R0000	253
	1SNK148042R0000	249		1SNK155052R0000	254		1SNK158032R0000	255
	1SNK148051R0000	247		1SNK155061R0000	252		1SNK158041R0000	253
	1SNK148052R0000	249		1SNK155062R0000	254		1SNK158042R0000	255
	1SNK148061R0000	247		1SNK155071R0000	252		1SNK158051R0000	253
	1SNK148062R0000	249		1SNK155072R0000	254		1SNK158052R0000	255
	1SNK148071R0000	247		1SNK155081R0000	252		1SNK158061R0000	253
	1SNK148072R0000	249		1SNK155082R0000	254		1SNK158062R0000	255
	1SNK148091R0000	247		1SNK155091R0000	252		1SNK158071R0000	253
	1SNK148092R0000	249		1SNK155092R0000	254		1SNK158072R0000	255
	1SNK148101R0000	247		1SNK155102R0000	252		1SNK158091R0000	253
	1SNK148102R0000	249		1SNK156011R0000	252		1SNK158092R0000	255
	1SNK148111R0000	247		1SNK156012R0000	254		1SNK158101R0000	253
	1SNK148112R0000	249		1SNK156021R0000	252		1SNK158102R0000	255
	1SNK148121R0000	247		1SNK156022R0000	254		1SNK158111R0000	253
	1SNK148122R0000	249		1SNK156031R0000	252		1SNK158112R0000	255
	1SNK148131R0000	247		1SNK156032R0000	254		1SNK158121R0000	253
	1SNK148132R0000	249		1SNK156041R0000	252		1SNK158122R0000	255
	1SNK148141R0000	247		1SNK156042R0000	254		1SNK158131R0000	253
	1SNK148142R0000	249		1SNK156051R0000	252		1SNK158132R0000	255
	1SNK148151R0000	247		1SNK156052R0000	254		1SNK158141R0000	253
	1SNK148152R0000	249		1SNK156061R0000	252		1SNK158142R0000	255
	1SNK148161R0000	247		1SNK156062R0000	254		1SNK158151R0000	253
	1SNK148162R0000	249		1SNK156071R0000	252		1SNK158152R0000	255
	1SNK148171R0000	247		1SNK156072R0000	254		1SNK158161R0000	253
	1SNK148172R0000	249		1SNK156081R0000	252		1SNK158162R0000	255
	1SNK148181R0000	247		1SNK156082R0000	254		1SNK158171R0000	253
	1SNK148182R0000	249		1SNK156091R0000	252		1SNK158172R0000	255
	1SNK148192R0000	247		1SNK156092R0000	254		1SNK158181R0000	253
	1SNK148202R0000	249		1SNK156101R0000	252		1SNK158182R0000	255
	1SNK148212R0000	247		1SNK156102R0000	254		1SNK158192R0000	253
	1SNK148222R0000	249		1SNK156111R0000	252		1SNK158202R0000	255
	1SNK149001R0000	247		1SNK156112R0000	254		1SNK158212R0000	253
	1SNK149002R0000	249		1SNK156121R0000	252		1SNK158222R0000	255
	1SNK149011R0000	247		1SNK156122R0000	254		1SNK159001R0000	253
	1SNK149012R0000	249		1SNK156131R0000	252		1SNK159002R0000	255
	1SNK149999R0000	21		1SNK156132R0000	254		1SNK159011R0000	253
MC512-YL	1SNK140004R0000	244		1SNK156141R0000	252		1SNK159012R0000	255
MC612	1SNK150000R0000	24		1SNK156142R0000	254	MC612-YL	1SNK159999R0000	24
MC612PA	1SNK150011R0000	252		1SNK156151R0000	252	MC612	1SNK150004R0000	250
	1SNK150012R0000	254		1SNK156152R0000	254	MC812	1SNK160000R0000	30
	1SNK150021R0000	252		1SNK156161R0000	252	MC812PA	1SNK160011R0000	257
	1SNK150022R0000	254		1SNK156162R0000	254		1SNK160012R0000	259
	1SNK150031R0000	252		1SNK156171R0000	252		1SNK160021R0000	257
	1SNK150032R0000	254		1SNK156172R0000	254		1SNK160022R0000	259
	1SNK150041R0000	252		1SNK156181R0000	252		1SNK160031R0000	257
	1SNK150042R0000	254		1SNK156182R0000	254		1SNK160032R0000	259
	1SNK150051R0000	252		1SNK156191R0000	252		1SNK160041R0000	257
	1SNK150052R0000	254		1SNK156192R0000	254		1SNK160042R0000	259
	1SNK150061R0000	252		1SNK156201R0000	252		1SNK160051R0000	257
	1SNK150062R0000	254		1SNK156202R0000	254		1SNK160052R0000	259
	1SNK150071R0000	252		1SNK156211R0000	252		1SNK160061R0000	257
	1SNK150072R0000	254		1SNK156212R0000	254		1SNK160062R0000	259
	1SNK150081R0000	252		1SNK156221R0000	252		1SNK160071R0000	257
	1SNK150082R0000	254		1SNK156222R0000	254		1SNK160072R0000	259
	1SNK150083R0000	252		1SNK156231R0000	252		1SNK160081R0000	257
	1SNK150084R0000	254		1SNK156232R0000	254		1SNK160082R0000	259
	1SNK150091R0000	252		1SNK156241R0000	253		1SNK160083R0000	257
	1SNK150092R0000	254		1SNK156242R0000	254		1SNK160084R0000	259
	1SNK150101R0000	252		1SNK156251R0000	253		1SNK160091R0000	257
	1SNK150102R0000	254		1SNK156252R0000	255		1SNK160092R0000	259
	1SNK150111R0000	252		1SNK156261R0000	253		1SNK160101R0000	257

Index

Type classification

Type	Part Number	Page	Type	Part Number	Page	Type	Part Number	Page
	1SNK160102R0000	259		1SNK166252R0000	260	MG2-STB 991005	1SNB991005R0000	266
	1SNK160111R0000	257		1SNK166261R0000	258	MG2-TCT 991562	1SNB991562R0000	266
	1SNK160112R0000	259		1SNK166262R0000	260	MG2-TDMO-01 40340	1SNB040340R0412	261
	1SNK1601121R0000	257		1SNK167001R0000	258	MG2-TDMO-01 40341	1SNB040341R0416	261
	1SNK160122R0000	259		1SNK167002R0000	260	MG2-TDMO-01 40390	1SNB040390R0412	261
	1SNK160131R0000	257		1SNK167011R0000	258	MG2-TDMO-01 40391	1SNB040391R0416	261
	1SNK160132R0000	259		1SNK167012R0000	260	MG2-TDMO-02 40440	1SNB040440R0412	261
	1SNK160141R0000	257		1SNK167021R0000	258	MG2-TDMO-02 40441	1SNB040441R0416	261
	1SNK160142R0000	259		1SNK167022R0000	260	MG2-TDMO-02 40490	1SNB040490R0412	261
	1SNK160151R0000	257		1SNK167031R0000	258	MG2-TDMO-02 40491	1SNB040491R0416	261
	1SNK160152R0000	259		1SNK167032R0000	260	MG2-TDMO-03 40540	1SNB040540R0412	261
	1SNK160161R0000	257		1SNK167041R0000	258	MG2-TDMO-03 40541	1SNB040541R0416	261
	1SNK160162R0000	259		1SNK167042R0000	260	MG2-TDMO-03 40590	1SNB040590R0412	261
	1SNK160171R0000	257		1SNK167051R0000	258	MG2-TDMO-03 40591	1SNB040591R0416	261
	1SNK160172R0000	259		1SNK167052R0000	260	MG2-TGT 991532	1SNB991532R0000	266
	1SNK160181R0000	257		1SNK167061R0000	258	MG2-TLT 991522	1SNB991522R0000	266
	1SNK160182R0000	259		1SNK167062R0000	260	MG2-TMT 991513	1SNB991513R0000	266
	1SNK160191R0000	257		1SNK167071R0000	258	MG2-TST 991552	1SNB991552R0000	266
	1SNK160192R0000	259		1SNK167072R0000	260	MG2-TTB 991512	1SNB991512R0000	266
	1SNK160201R0000	257		1SNK167081R0000	258	MG2-TTD 991563	1SNB991563R0000	266
	1SNK160202R0000	259		1SNK167082R0000	260	MG2-TWC 991502	1SNB991502R0000	266
	1SNK165011R0000	257		1SNK167091R0000	258	MG2-TWT 991542	1SNB991542R0000	266
	1SNK165012R0000	259		1SNK167092R0000	260	MG2-WTB 991004	1SNB991004R0000	266
	1SNK165021R0000	257		1SNK168001R0000	258	MG3 KIT	1SNB419001R0000	244
	1SNK165022R0000	259		1SNK168002R0000	260	MG-CPM 13 41740	1SNB041740R0512	244
	1SNK165031R0000	257		1SNK168011R0000	258	MG-CPM 13 41741	1SNB041741R0612	250
	1SNK165032R0000	259		1SNK168012R0000	260	MG-CPM 13 41790	1SNB041790R0512	21
	1SNK165041R0000	257		1SNK168021R0000	258	MG-CPM 13 41791	1SNB041791R0612	30
	1SNK165042R0000	259		1SNK168022R0000	260	MG-CPMFA 43196	1SNB043196R0012	185
	1SNK165051R0000	257		1SNK168031R0000	258	MG-TAA 49148	1SNB049148R1735	201
	1SNK165052R0000	259		1SNK168032R0000	260	MG-TAA 49198	1SNB049198R1735	201
	1SNK165061R0000	257		1SNK168041R0000	258	MG-TAA 49448	1SNB049448R8530	201
	1SNK165062R0000	259		1SNK168042R0000	260	MG-TAA 49498	1SNB049498R8530	201
	1SNK165071R0000	257		1SNK168051R0000	258	MG-TAPW 49046	1SNB049046R0929	263
	1SNK165072R0000	259		1SNK168052R0000	260	MG-TAPW 49096	1SNB049096R0929	263
	1SNK165081R0000	257		1SNK168061R0000	258	MG-TAR 45194	1SNB045194R1735	201
	1SNK165082R0000	259		1SNK168062R0000	260	MG-TAR 45490	1SNB045490R8530	201
	1SNK165091R0000	257		1SNK168071R0000	258	MG-VYT 46415	1SNB046415R0615	217
	1SNK165092R0000	259		1SNK168072R0000	260	MG-VYT 46915	1SNB046915R0615	217
	1SNK165102R0000	259		1SNK168091R0000	258	PAM43020	1SNA235106R2600	230
	1SNK166011R0000	257		1SNK168092R0000	260	PC5-10	1SNA113544R1200	105
	1SNK166012R0000	259		1SNK168101R0000	258	PC5-2	1SNA113542R1000	105
	1SNK166021R0000	257		1SNK168102R0000	260	PC8-10	1SNA163313R2400	155
	1SNK166022R0000	259		1SNK168111R0000	258	PC81-10	1SNA173523R1100	120
	1SNK166031R0000	257		1SNK168112R0000	260	PC8-2	1SNA116538R1700	226
	1SNK166032R0000	259		1SNK168121R0000	258	PC8-3	1SNA116539R1000	226
	1SNK166041R0000	257		1SNK168122R0000	260	PC8-4	1SNA116540R2500	226
	1SNK166042R0000	259		1SNK168131R0000	258	PC8-R1	1SNA400711R0600	153
	1SNK166051R0000	257		1SNK168132R0000	260	PC8-R2	1SNA400712R0700	155
	1SNK166052R0000	259		1SNK168141R0000	258	PC8-R3	1SNA400713R0000	155
	1SNK166061R0000	257		1SNK168142R0000	260	PC8-R4	1SNA400724R0300	155
	1SNK166062R0000	259		1SNK168151R0000	258	PC8-R5	1SNA400842R0000	155
	1SNK166071R0000	257		1SNK168152R0000	260	PC8-R6	1SNA400843R0000	155
	1SNK166072R0000	259		1SNK168161R0000	258	PC8-R7	1SNA400849R0000	155
	1SNK166081R0000	257		1SNK168162R0000	260	PC8-R8	1SNA400850R0000	155
	1SNK166082R0000	259		1SNK168171R0000	258	PEN HOLDER	1SNA360098R1200	268
	1SNK166091R0000	257		1SNK168172R0000	260	PG5	1SNK900401R0000	52
	1SNK166092R0000	259		1SNK168181R0000	258	PG5-R1	1SNK900402R0000	52
	1SNK166101R0000	257		1SNK168182R0000	260	PG5-R2	1SNK900403R0000	211
	1SNK166102R0000	259		1SNK168192R0000	260	PIB2-TT	1SNA235155R2600	201
	1SNK166111R0000	257		1SNK168202R0000	260	PIB2-TT-YL	1SNA235157R2000	201
	1SNK166112R0000	259		1SNK168212R0000	260	PL10	1SNK900621R0000	85
	1SNK166121R0000	257		1SNK168222R0000	260	PL16	1SNK900622R0000	87
	1SNK166122R0000	259		1SNK169001R0000	258	PL5	1SNK900618R0000	80
	1SNK166131R0000	257		1SNK169002R0000	260	PL6	1SNK900619R0000	81
	1SNK166132R0000	259		1SNK169011R0000	258	PL8	1SNK900620R0000	84
	1SNK166141R0000	257		1SNK169012R0000	260	PR3_G2	1SNA164800R0300	197
	1SNK166142R0000	259		1SNK169999R0000	30	PR3_Z2	1SNA174300R1700	196
	1SNK166151R0000	257	MC812-YL	1SNK160004R0000	256	PR30	1SNA173220R0500	196
	1SNK166152R0000	259	MCLH	1SNK900630R0000	201	PR4	1SNA168500R1200	198
	1SNK166161R0000	257	MCLH-R1	1SNK900631R0000	201	PR5	1SNA168700R2200	198
	1SNK166162R0000	259	MCLH-R1-YL	1SNK900634R0000	201	PR50	1SNA178529R0400	197
	1SNK166171R0000	257	MCLH-YL	1SNK900633R0000	201	PS-3	1SNK900650R0000	213
	1SNK166172R0000	259	MG2-ABM 991012	1SNB991012R0000	266	PT-3	1SNK900625R0000	210
	1SNK166181R0000	257	MG2-CKP 991670	1SNB991670R0000	266	PT-ZD	1SNK900660R0000	185
	1SNK166182R0000	259	MG2-CTB 991006	1SNB991006R0000	266	RC1010	1SNA238000R1600	91
	1SNK166191R0000	257	MG2-ETB 991016	1SNB991016R0000	244	RCPEAD-TT	1SNA235158R0100	201
	1SNK166192R0000	259	MG2-ETR 991600	1SNB991600R0000	266	RCPEAD-TT-YL	1SNA235159R0200	201
	1SNK166201R0000	257	MG2-ETR 991601	1SNB991601R0000	266	RCPEB	1SNA178430R0500	201
	1SNK166202R0000	259	MG2-ETR 991602	1SNB991602R0000	266	RIB-B	1SNA235710R0600	265
	1SNK166211R0000	257	MG2-ETR 991603	1SNB991603R0000	266	RIB-R	1SNA235711R2300	265
	1SNK166212R0000	259	MG2-ETR 991606	1SNB991606R0000	266	RIB-RS	1SNA235718R0200	265
	1SNK166221R0000	257	MG2-LTB 991013	1SNB991013R0000	266	RIIS	1SNK900627R0000	219
	1SNK166222R0000	259	MG2-MTB 991008	1SNB991008R0000	266	SC-JB8-2	1SNK900652R0000	152
	1SNK166231R0000	258	MG2-PLT 991002	1SNB991002R0000	266	SC-JB8-3	1SNK900653R0000	156
	1SNK166232R0000	260	MG2-PTD 991007	1SNB991007R0000	266	SC-JB8-3-OR	1SNK900657R0000	231
	1SNK166241R0000	258	MG2-PTM 991010	1SNB991010R0000	261	SC-JB8-4	1SNK900654R0000	156
	1SNK166242R0000	260	MG2-PWC 991000	1SNB991000R0000	266	SC-JB8-4-OR	1SNK900658R0000	231
	1SNK166251R0000	258	MG2-QTB 991011	1SNB991011R0000	266	SC-JB8-5	1SNK900655R0000	231

Index

Type classification

Type	Part Number	Page	Type	Part Number	Page	Type	Part Number	Page
ZS50-YL	1SNK516060R0000	88						
ZS6	1SNK506010R0000	81						
ZS6-3S	1SNK506011R0000	82						
ZS6-3S-BL	1SNK506021R0000	82						
ZS6-3S-PE	1SNK506151R0000	82						
ZS6-3S-YL	1SNK506067R0000	82						
ZS6-4S	1SNK506012R0000	83						
ZS6-4S-BL	1SNK506022R0000	83						
ZS6-4S-PE	1SNK506152R0000	83						
ZS6-4S-YL	1SNK506068R0000	83						
ZS6-BK	1SNK506066R0000	81						
ZS6-BL	1SNK506020R0000	81						
ZS6-BR	1SNK506064R0000	81						
ZS6-D1	1SNK506211R0000	139						
ZS6-D1-PE	1SNK506250R0000	138						
ZS6-D1-RD	1SNK506214R0000	139						
ZS6-D2	1SNK506210R0000	138						
ZS6-D2-BK	1SNK506266R0000	138						
ZS6-D2-BL	1SNK506220R0000	138						
ZS6-D2-OR	1SNK506230R0000	138						
ZS6-D2-PE	1SNK506212R0000	140						
ZS6-D2-RD	1SNK506262R0000	138						
ZS6-D2-WH	1SNK506265R0000	138						
ZS6-D2-YL	1SNK506260R0000	138						
ZS6-GN	1SNK506061R0000	81						
ZS6-OR	1SNK506030R0000	81						
ZS6-PE	1SNK506150R0000	81						
ZS6-PR	1SNK506063R0000	81						
ZS6-RD	1SNK506062R0000	81						
ZS6-S	1SNK506315R0000	109						
ZS6-S-4S-T2	1SNK506316R0000	110						
ZS6-S-BL	1SNK506322R0000	109						
ZS6-WH	1SNK506065R0000	81						
ZS6-YL	1SNK506060R0000	81						
ZS70	1SNK522010R0000	89						
ZS70-BL	1SNK522020R0000	89						
ZS70-PE	1SNK522150R0000	89						
ZS70-YL	1SNK522060R0000	89						
ZS95	1SNK526010R0000	90						
ZS95-BL	1SNK526020R0000	90						
ZS95-PE	1SNK526150R0000	90						
ZS95-YL	1SNK526060R0000	90						

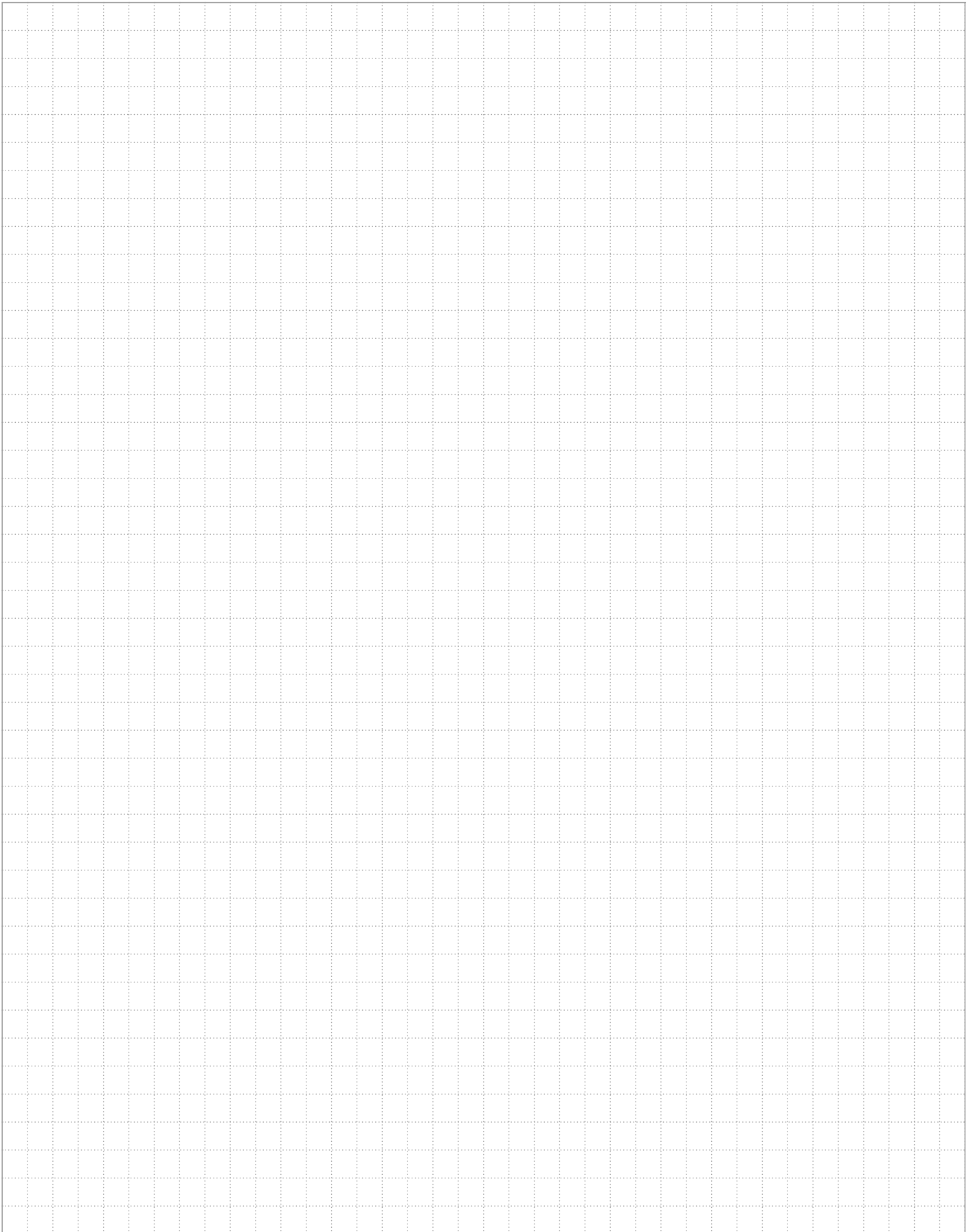

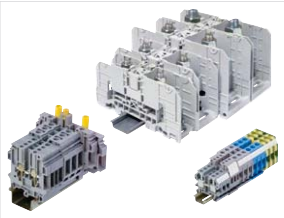

DEDICATED APPLICATIONS TERMINAL BLOCKS

IDC, spring loaded, stud, screw, spring, pluggable technologies

ENTRELEC Terminal Blocks

ENTRELEC Terminal blocks

TE Connectivity proposes one of the largest Din Rail Terminal block offering on the market with various technologies: screw, PI-Spring, spring, IDC, pluggable, stud, etc. found in over 8000 products & solutions.

You can access to more product details, use the order code or the product type in our web site: te.com

D2.5/S.ADO IDC terminal blocks
Feed-through ADO - screw clamp - 5 mm 0.197 in spacing



1 mm² 18 AWG

Description

- With the TE Connectivity ADO System™, experience the fastest and most reliable connection on the market.
- This solution brings all the benefits of the ADO System™ and allows you to connect standard screw clamps.
- Up to 2 wires per connection in the ADO System™ connection.

Ordering details

Description	Color	Type	Part Number	PKG	Design
Feed-through	Gray	Standard	15NA19954R2300	50	15NA19954R2300
Feed-through	Gray	Standard	15NA19954R2300	50	15NA19954R2300
Feed-through	Gray	Standard	15NA19954R2300	50	15NA19954R2300

Main technical data

ADO	AWG	UL	CSA	Wire stripping length	Wire diameter
ADO	18-22	UL	CSA	18 mm	1.6 mm
ADO	18-22	UL	CSA	18 mm	1.6 mm
ADO	18-22	UL	CSA	18 mm	1.6 mm

Mounting options

Mounting options	Part Number	Design
Mounting options	15NA19954R2300	15NA19954R2300
Mounting options	15NA19954R2300	15NA19954R2300
Mounting options	15NA19954R2300	15NA19954R2300

Material

Material	Part Number	Design
Material	15NA19954R2300	15NA19954R2300
Material	15NA19954R2300	15NA19954R2300
Material	15NA19954R2300	15NA19954R2300



ACTIVE

TE Part # 15NA19954R2300
TE Internal #: 15NA19954R2300

Add to List

Compatible Parts & Tooling

Documents Features Product Compliance

Datasheets & Catalog Pages

ENTRELEC Terminal Blocks Catalogue (RUS)
RUS_DS_11773967-1_RUS_1218.pdf
ENO_DS_15NA19954R2300_A.pdf English

15NCA1600650201



Dedicated applications

Terminal blocks



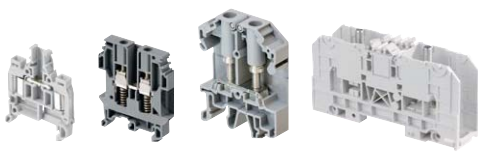
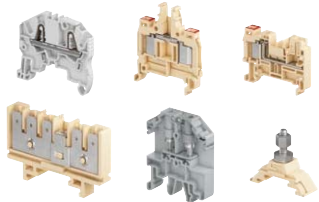

<u>Connection devices offering</u>	2	1
<u>ADO System® IDC terminal blocks</u>	11	2
<u>Spring loaded screw clamp terminal blocks</u>	59	3
<u>Stud terminal blocks</u>	71	4
<u>Ring lug terminal blocks</u>	99	5
<u>Miniblocks</u>	109	6
<u>Test & measurement terminal blocks</u>	153	7
<u>Pluggable terminal blocks</u>	173	8
<u>Sensors / Actuators terminal blocks</u>	189	9
<u>Installation terminal blocks</u>	207	10
<u>Protection terminal blocks</u>	237	11
<u>Disconnect terminal blocks</u>	243	12
<u>Component holder terminal blocks</u>	251	13
<u>Index</u>	265	14

TE Connectivity proposes one of the largest Din Rail Terminal block offering on the market with various technologies: screw, PI-Spring, spring, IDC, pluggable, stud, etc. found in over 8000 products & solutions.

	SNK terminal blocks		Dedicated applications terminal blocks		Terminal blocks for railway applications
					
Scope	Qualified for worldwide applications and severe environments (such as hazardous locations, railways, marine and solar applications..). From 0.2 to 300 mm ² .		Specific terminal blocks and technologies for dedicated applications and markets.		The largest offering on the market for rolling stock and infrastructures.
Product families & functions	SNK PI-Spring technology 2.5 to 16 mm ² 12 to 4 AWG	Feed-through Multi-deck Ground Disconnect for fuses Component holder	ADO System® (IDC) 0.22 to 4 mm ² 24 to 12 AWG	ADO-ADO or ADO-screw clamp Feed-through / Multi-deck / Ground / Disconnect / for fuses / Component holder	SNK PI-Spring technology 2.5 to 16 mm ² 12 to 4 AWG
			Safety (spring loaded) 0.22 to 10 mm ² 24 to 6 AWG	Feed-through Disconnect Test & measurement	SNK pluggable screw & PI-Spring technologies 2.5 to 4 mm ² 12 to 10 AWG
	SNK screw clamp technology 4 to 240 mm ² 12 to 500 Kcmil	Feed-through Multi-deck Ground Disconnect for fuses Test & measurement Marshalling Component holder	Stud 25 to 300 mm ² 4 AWG to 1000 Kcmil	One stud 2 studs One stud - One screw clamp	ADO System® (IDC) 1.5 to 4 mm ² 16 to 12 AWG
			Ring lug 6 to 16 mm ² 8 to 6 AWG	Feed-through Test & measurement	Stud 4 to 185 mm ²
	SNK pluggable screw & PI-Spring technologies 2.5 to 4 mm ² 12 to 10 AWG	Feed-through Multi-deck Ground	Miniblocks 1.5 to 6 mm ² 18 to 8 AWG	Screw clamp Spring ADO System® (IDC)	Quick-connect 2.5 to 6 mm ²
			Other types Test & measurement: with sliding link, blade, plug Pluggable: feed-through, double deck, disconnect Sensors/actuators: screw, spring, ADO system (IDC) Installation: screw, spring Protection: ground + neutral Component holders: screw, spring, ADO system (IDC)		



www.te.com

DBL power distribution blocks	ESSAILEC® test blocks	Interfast PLC pre-wiring system	Marking solutions
			
<p>The preferred choice for primary power distribution and solar applications.</p>	<p>Test blocks for safe and easy testing on secondary circuits of current and voltage transformers and sensors.</p>	<p>PLC pre-wiring system for fast, flexible, reliable connection of PLC's in process automation applications.</p>	<p>Markers & marking systems for all identification requirements in electrical panels.</p>
<p>From 80 A up to 550 A (IEC)</p> <p>Modular blocks: single pole, three & four poles, up to 12 outputs</p> <p>Terminal blocks types: 2 to 10 poles, up to 20 outputs</p>	<p>Current and voltage sockets & plugs</p> <p>Simultaneous testing of 1 to 4 independent circuits on the same socket</p> <p>Several testing principle such as "make before break" for safe current transformer testing</p> <p>Panel and switchboard mounting : base, flush, rack, TH35 rail</p> <p>Multicircuits sockets & plugs</p>	<p>Interfast PCB: Compact & standard modules</p> <p>Interfast MS: Modular system based on terminal block technology</p> <p>Functions:</p> <ul style="list-style-type: none"> - 1 to 4 wire connections (sensors) - Disconnect - Fuse - Signal indication - Relays - Optocouplers - Solenoid valve control - Galvanic isolation (2.5 kV). 	<p>Terminal block identification and group markers</p> <p>Wire and cable identification</p> <p>Component and equipment identification</p> <p>Panel identification</p> <p>Pre-printed markers for terminal blocks</p>

Screw clamp technology

The heavy duty connection

Unique design, flies over time thanks to its reliability and safety

The TE Connectivity screw clamp technology is designed to avoid accidental releases due to vibrations, shocks or even abusive cable draw. Our exclusive design minimizes the needs of retightening campaigns.

High density capacity

The screw clamp technology can fit up to two conductors per clamp which offers extended possibilities in electrical cabinets.

Features

The TE Connectivity exclusive anti-release system creates a controlled locking-screw effect thanks to the 2 overlapping tabs that maintain the clamp parts. The screw is locked in total safety. The retightening campaigns are not needed anymore!

The clamp is punched, which increases the number of screw threads by 30 % meaning a high torque resistance

Hardened steel makes the connection very reliable

Flap avoiding the insertion of cable underneath the clamp

The screw tightens the conductive bar to the cable. There is no torsion effect applied to the cable

Screw

Screw clamp

Conductive linking bar

Stripped wire

From 0.22 mm² up to 240 mm²
From 24 AWG up to 500 Kcmil

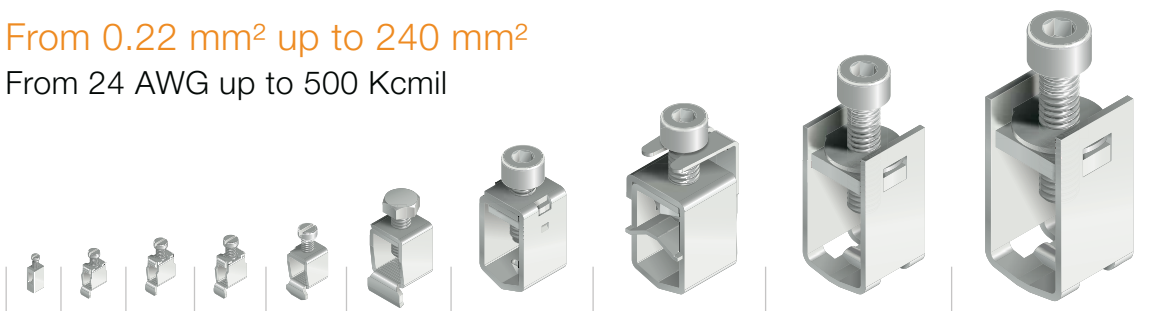

TE Connectivity spring loaded screw clamp technology

The safety connection for demanding working conditions

Exclusive design provide robustness and connection safety

The TE Connectivity screw clamp spring loaded terminal is designed to guarantee electrical continuity even when screws are loosened unintentionally.

It features all the benefits of our screw clamp with additional vibration, shock resistant and maintenance free performances.

High density wiring

The screw clamp spring loaded terminal can fit up to two conductors equipped with bent ferrules per clamp.

Features

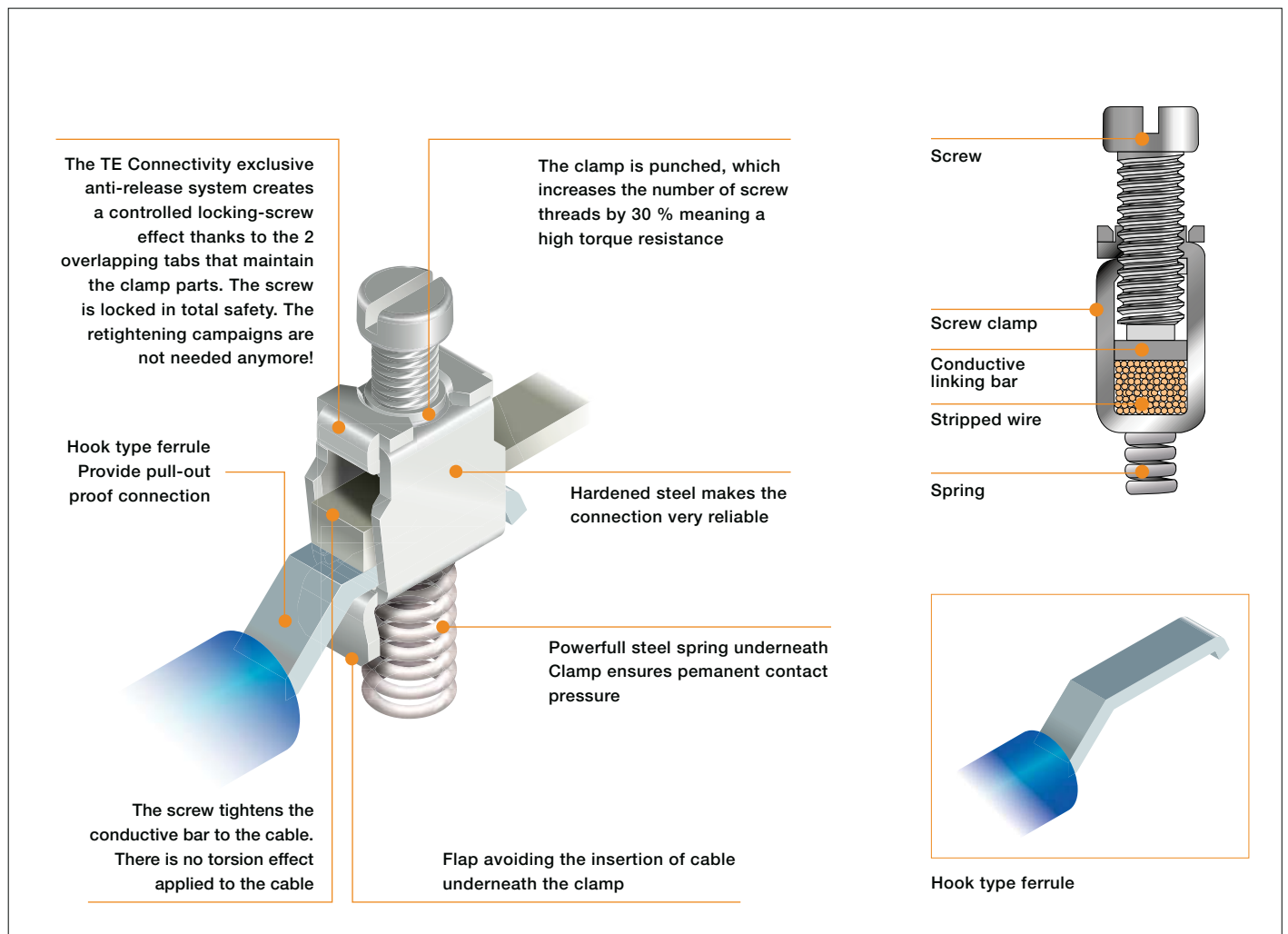

From 0.22 mm² up to 10 mm²

From 24 AWG up to 6 AWG

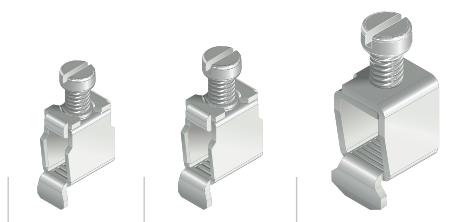

TE Connectivity spring clamp technology

Experience the flexible connection

The TE Connectivity spring clamp technology combines all the features appreciated from electrical users by combining flexibility of use with front entry, a good vibration withstand, clamping pressure non dependent on the operator and automatic creeping compensation suppressing the needs of retightening campaigns.

Features

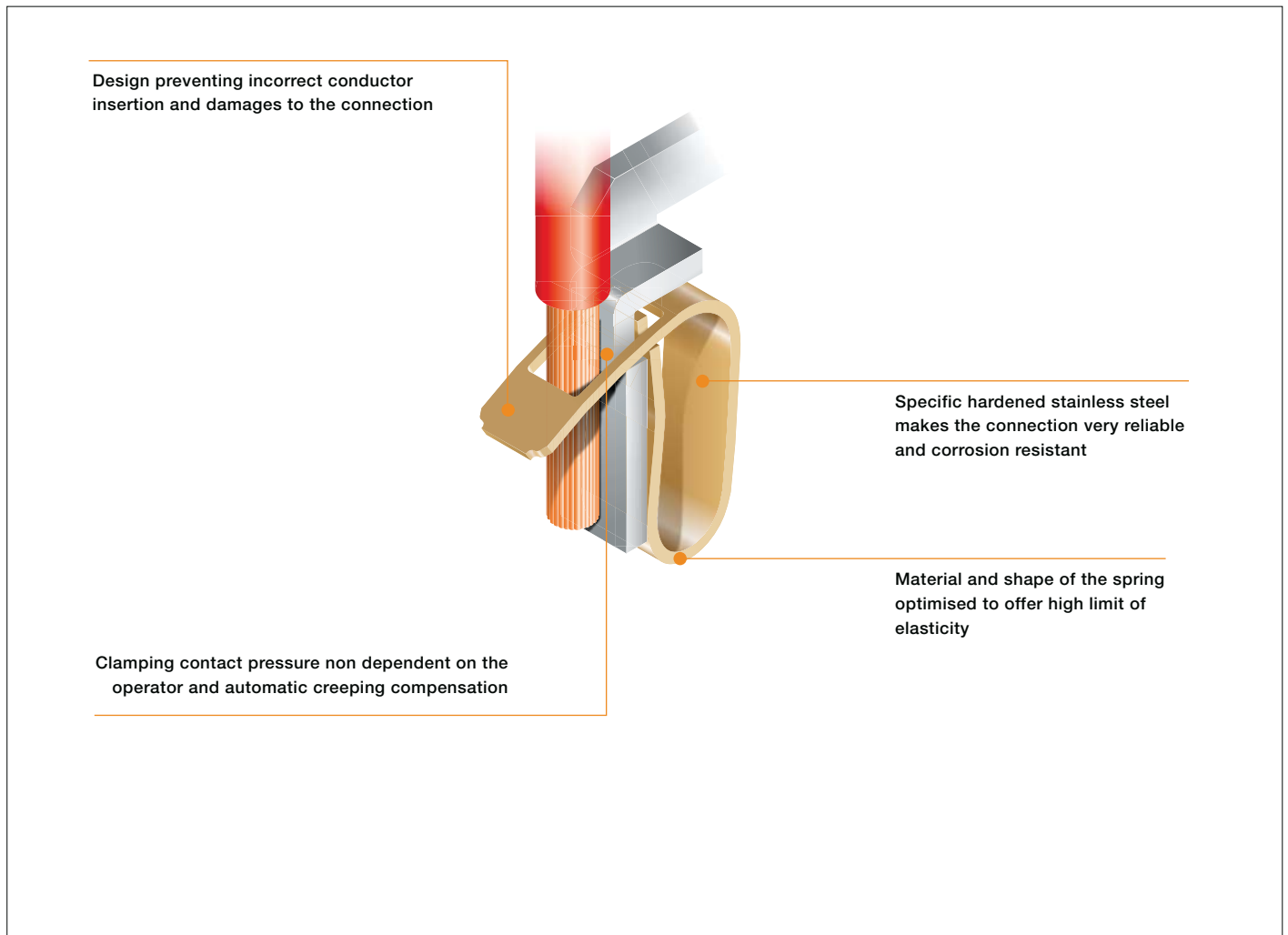

From 0.12 mm² up to 35 mm²

From 26 AWG up to 2 AWG



1SNC16212S0201

ADO System® IDC technology

The fastest and most reliable connection technology

ADO system® is based on Insulation Displacement Connection (IDC) technology. IDC technology can be found in various applications outside the electrical world. (RJ45 connectors used in Telecom for instance).

Our ADO system® features one single piece which (when associated with its dedicated tool) combines the wire preparation and the wire connection. Its design is made to connect up to two conductors (standard wires as well as special wires) in the same jaw.

Features

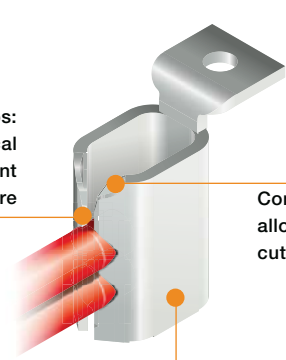

Contact lips: allows the electrical contact with a permanent cable contact pressure

Cone entry shape: allows the insulation cutting

ADO system® jaw: "C shape" spring

Corrosion proof

Gas-tight connection
Contact points are wrapped by the insulation.

Low galvanic couple of copper alloy jaw pinching the wire at two points.

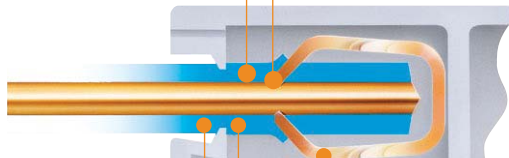

Vibration proof

Wire insulation is pinched by the insulating body.

Unstripping insulator absorbs vibrations.

Contact forces are permanently balanced.

Instructions:

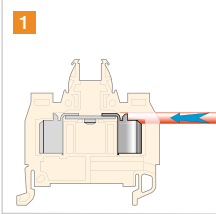

1 Insert the wire (not stripped) in the ADO System® jaw until it butts.

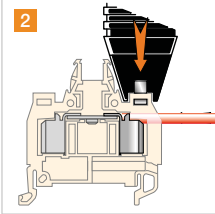

2 Position the tool in the recess and pull the trigger fully and release it.

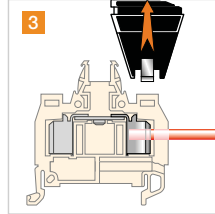

3 Remove the trigger. (the tool will not be released if the connection is not completed).

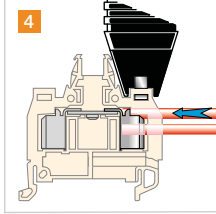

4 Follow the same process if a second wire has to be connected (same size and same nature). The first wire preliminary installed, will remain perfectly and safely maintained in the clamp during the second wire cabling process.

Two conductors

From 0.22 mm² up to 4 mm²
From 24 AWG up to 12 AWG

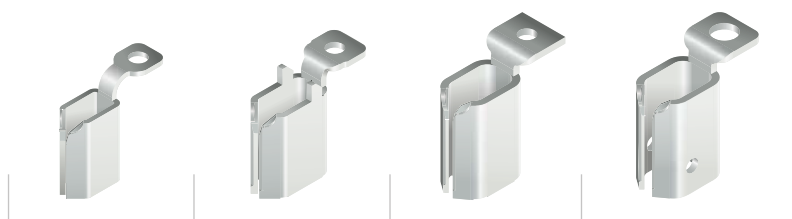

TE Connectivity Stud technology

The connection for power and energy circuits

Reliability first

Stud technology is designed to ensure a reliable connection thanks to the combination of:

- Vibration resistant equipments (nuts, washers),
- Lugs crimped on the cable provide pull-out proof termination.

This technology is very popular on the American market and particularly in the energy applications.

Available configurations

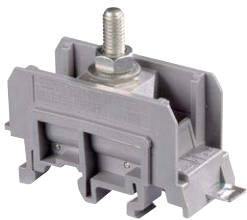

One stud

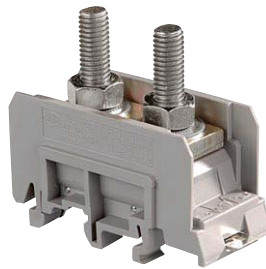

Two studs

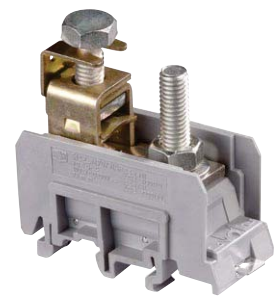

One screw clamp / one stud

Connection technics

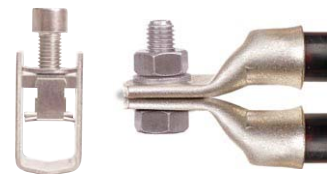
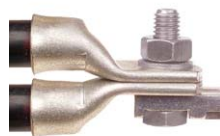

Up to 300 mm² / 1 000 Kcmil



M4-M5
6 mm²
8 AWG



M6
35 mm²
1 AWG



M8
70 mm²
000 AWG



M10
120 mm²
300 Kcmil



M12
185 mm²
500 Kcmil



M16
300 mm²
1 000 Kcmil



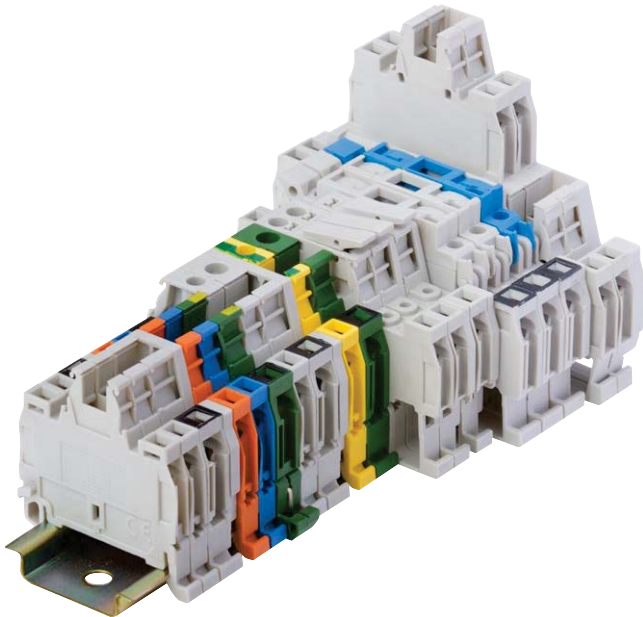

1SINC163102S0201

Dedicated applications terminal blocks

ADO System® IDC technology

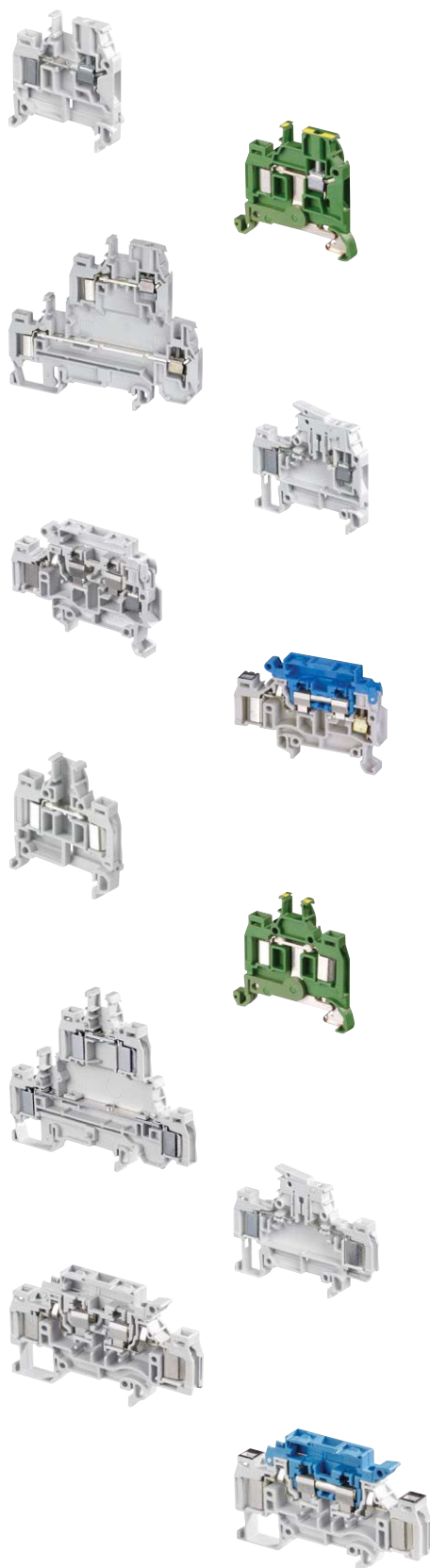

Technologies presentation	12
Overview	14

ADO / screw clamp

Feed-through

1 mm ² / 18 AWG	D2.5/5.ADO	17
1.5 mm ² / 16 AWG	D4/6.ADO	18
2.5 mm ² / 14 AWG	D6/8.ADO	20
4 mm ² / 12 AWG	D6/8.ADO3	22

Ground

1 mm ² / 18 AWG	D2.5/5.P.ADO	23
1.5 mm ² / 16 AWG	D4/6.P.ADO	24
2.5 mm ² / 14 AWG	D6/8.P.ADO	25
4 mm ² / 12 AWG	D6/8.P.ADO3	26

Double deck

1.5 mm ² / 16 AWG	D4/6.D2.ADO	27
2.5 mm ² / 14 AWG	D6/8.D2.ADO	28

Disconnect with blade

1 mm ² / 18 AWG	D2.5/5.SN.ADO	29
1.5 mm ² / 16 AWG	D4/6.SN.ADO	31
2.5 mm ² / 14 AWG	D4/8.SN.ADO	33

For 5 x 20 and 5 x 25 mm fuse (0.197 x 0.787 in and 0.197 x 0.984 in)

1.5 mm ² / 16 AWG	D4/8.SF...I.ADO	34 to 36
2.5 mm ² / 14 AWG	D4/8.SF...I.ADO2	37 to 38

Disconnect with lever

1.5 mm ² / 16 AWG	D4/8.SN...I.ADO	39
2.5 mm ² / 14 AWG	D4/8.SN...I.ADO2	40

ADO / ADO

Feed-through

1 mm ² / 18 AWG	D1/5.ADO	41
1.5 mm ² / 16 AWG	D1.5/6.ADO	42
2.5 mm ² / 14 AWG	D2.5/8.ADO	43
4 mm ² / 12 AWG	D4/8.ADO	44

Ground

1 mm ² / 18 AWG	D1/5.P.ADO	45
1.5 mm ² / 16 AWG	D1.5/6.P.ADO	46
2.5 mm ² / 14 AWG	D2.5/8.P.ADO	47
4 mm ² / 12 AWG	D4/8.P.ADO	48

Double deck

1.5 mm ² / 16 AWG	D1.5/6.D2.ADO	49
------------------------------	---------------	----

Disconnect with blade

1 mm ² / 18 AWG	D1/5.SNT2.ADO	50
1.5 mm ² / 16 AWG	D1.5/6.SNT2.ADO	51
2.5 mm ² / 14 AWG	D2.5/8.SNT2.ADO	52

For 5 x 20 and 5 x 25 mm fuse (0.197 x 0.787 in and 0.197 x 0.984 in)

1.5 mm ² / 16 AWG	D1.5/8.SF.ADO	53 to 54
2.5 mm ² / 14 AWG	D2.5/8.SF.ADO2	55 to 56

Disconnect with lever

2.5 mm ² / 14 AWG	D4/8.SNNT.ADO2	57
------------------------------	----------------	----

Dedicated applications terminal blocks

ADO System® IDC technology



Rely on our expertise

With ADO System®, TE Connectivity is the leader in IDC technology since 25 years. More than 4000 customers worldwide are using this technology with success in the most severe environments.

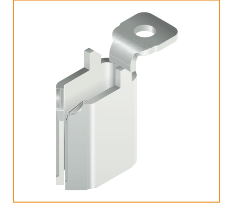

Qualified for worldwide markets and applications
Eco-designed according to international environmental standards in sustainable development.



Experience the fastest and the most reliable connection on the market

Secure your connection process

Tool is **locked** on terminal block **during all connection process**. The conductor requires **no preparation** (no stripping, no ferrule). **Maintenance free** (screwless connection).

No fatigue thanks to the use of automatic tool.

Well adapted to special cables.

Speed up your wiring process and reduce time to market!

Reduce wiring time up to 80 % compare to a screw connection with ferrules.

High speed Connection process: **less than 3 seconds!**

No preparation of cable, no tightening, no use of ferrules.

Pneumatic tool available for even faster process.

Trust ADO System® reliability in any environments

ADO System® technology provides **superior performances** and is the best solution for installations with **severe** constraints (continuity of service, clearance for work) as well as strong environmental requirements (**vibrations, corrosion**) This is the reason why today ADO System® is successfully used in **chemical/petrochemical, traction, waste water treatment** environments.



Connection process secured:
Tool locked on terminal blocks, high speed connection

1SNC163079S0201

ADO System® IDC technology

The fastest and most reliable connection technology

ADO System® is based on Insulation Displacement Connection (IDC) technology. IDC technology can be found in various applications outside the electrical world. (RJ45 connectors used in Telecom for instance).

Our ADO System® features one single piece which (when associated with its dedicated tool) combines the wire preparation and the wire connection. Its design is made to connect up to two conductors (standard wires as well as special wires) in the same jaw.

Features

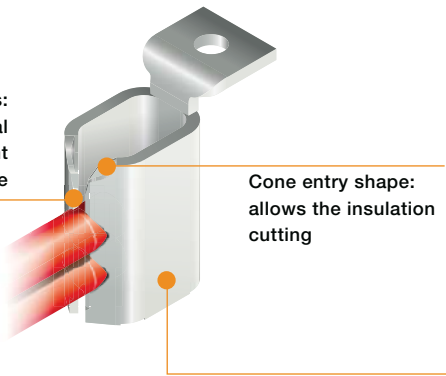

Contact lips:
allows the electrical contact with a permanent cable contact pressure

Cone entry shape:
allows the insulation cutting

ADO System® jaw:
"C shape" spring

Corrosion proof

Gas-tight connection
Contact points are wrapped by the insulation.

Low galvanic couple of copper alloy jaw pinching the wire at two points.

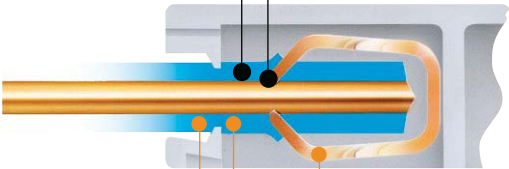

Vibration proof

Wire insulation is pinched by the insulating body.

Unstripping insulator absorbs vibrations.

Contact forces are permanently balanced.

Instructions:

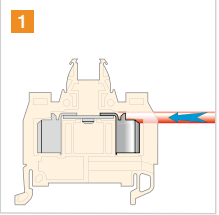

1

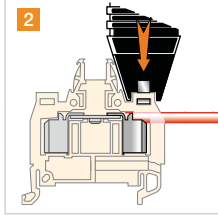

2

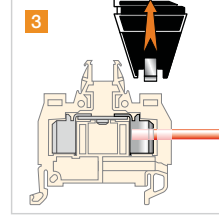

3

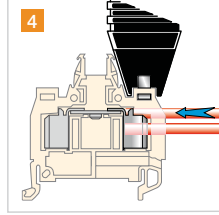

4

Two conductors

- 1** Insert the wire (not stripped) in the ADO System® jaw until it butts.
- 2** Position the tool in the recess and pull the trigger fully and release it.
- 3** Remove the trigger. (the tool will not be released if the connection is not completed).
- 4** Follow the same process if a second wire has to be connected (same size and same nature). The first wire preliminary installed, will remain perfectly and safely maintained in the clamp during the second wire cabling process.

From 0.22 mm² up to 4 mm²
From 24 AWG up to 12 AWG

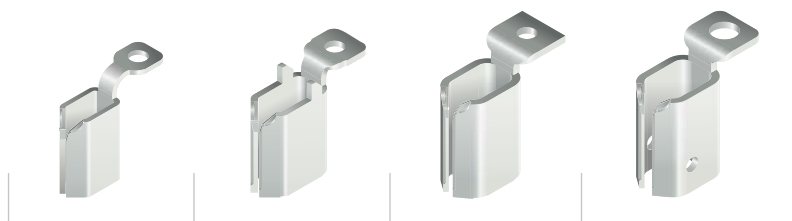

Dedicated applications terminal blocks

ADO System® IDC technology

ADO / screw clamp



Feed-through



Ground



Double deck

Section		Feed-through		Ground		Double deck	
IEC	UL/CSA						
1 mm ²	18 AWG	D2.5/5.ADO	5 mm 0.197 in	D2.5/5.PADO	5 mm 0.197 in		
1.5 mm ²	16 AWG	D4/6.ADO	6 mm 0.236 in	D4/6.PADO	6 mm 0.236 in	D4/6.D2.ADO	6 mm 0.236 in
2.5 mm ²	14 AWG	D6/8.ADO	8 mm 0.315 in	D6/8.PADO	8 mm 0.315 in	D6/8.D2.ADO	8 mm 0.315 in
4 mm ²	12 AWG	D6/8.ADO3	8 mm 0.315 in	D6/8.PADO3	8 mm 0.315 in		

ADO / ADO



Feed-through



Ground



Double deck

Section		Feed-through		Ground		Double deck	
IEC	UL/CSA						
1 mm ²	18 AWG	D1/5.ADO	5 mm 0.197 in	D1/5.PADO	5 mm 0.197 in		
1.5 mm ²	16 AWG	D1.5/6.ADO	6 mm 0.236 in	D1.5/6.PADO	6 mm 0.236 in	D1.5/6.D2.ADO	6 mm 0.236 in
2.5 mm ²	14 AWG	D2.5/8.ADO	8 mm 0.315 in	D2.5/8.PADO	8 mm 0.315 in		
4 mm ²	12 AWG	D4/8.ADO	8 mm 0.315 in	D4/8.PADO	8 mm 0.315 in		

Complementary functions: see related chapters in this catalog



Miniblocks

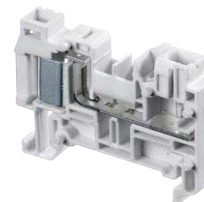

Pluggable



Disconnect with blade



D2.5/5.SN.ADO	5 mm 0.197 in
D4/6.SN.ADO	6 mm 0.236 in
D4/8.SN.ADO	8 mm 0.315 in



Fuse



D4/8.SF...I.ADO	8 mm 0.315 in
D4/8.SF...I.ADO2	8 mm 0.315 in

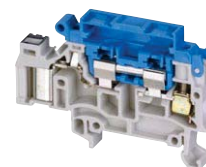

Disconnect with lever



D4/8.SN...I.ADO	8 mm 0.315 in
D4/8.SN...I.ADO2	8 mm 0.315 in

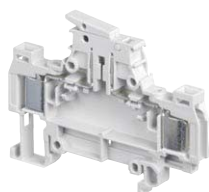

Disconnect with blade



D1/5.SNT2.ADO	5 mm 0.197 in
D1.5/6.SNT2.ADO	6 mm 0.236 in
D2.5/8.SNT2.ADO	8 mm 0.315 in



Fuse



D1.5/8.SF.ADO	8 mm 0.315 in
D2.5/8.SF.ADO2	8 mm 0.315 in

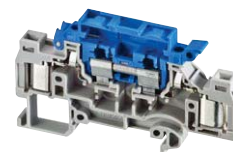

Disconnect with lever



D1.5/8.SNN.ADO	8 mm 0.315 in
D2.5/8.SNNT.ADO2	8 mm 0.315 in



Sensors / actuators



Component holders

D2.5/5.ADO IDC terminal blocks

Feed-through ADO - screw clamp - 5 mm 0.197 in spacing



D2.5/5.ADO

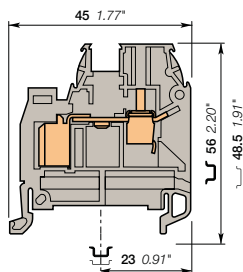

5 mm 0.197 in spacing

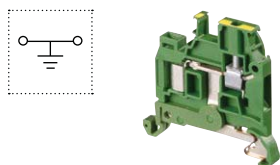
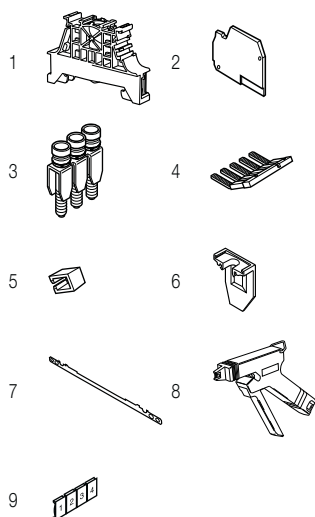

Description

- With the TE Connectivity ADO System®, experience the fastest and most reliable connection on the market,
- This solution brings all the benefits of the ADO System® and allows installators to connect on standard screw clamp,
- Up to 2 wires per connection in the ADO System® connection.

Ordering details

Description	Color	Type	Part Number	Pkg pce	Weight (1 pce) g
Feed-through	Grey	D2.5/5.ADO	1SNA199554R2300	50	6.00
	Blue	D2.5/5.N.ADO	1SNA199556R2500	50	6.00
	Orange	D2.5/5.ADO	1SNA199555R2400	50	6.00

Main technical data

		IEC	UL	CSA	Mounting instructions	
ADO	Rigid: Solid/Stranded	0.2-1 mm²		24-18 AWG	Rail	TH 35-7.5, TH 35-15
	Flexible without ferrule	0.22-1 mm²		24-18 AWG	Wire stripping length	9.5 mm 0.37 in
Screw clamp	Rigid: Solid/Stranded	0.2-4 mm²		22-12 AWG	Tool	Flat screwdriver Ø 3.5 mm Ø 0.138 in
	Flexible without ferrule	0.22-2.5 mm²				
	Flexible with insulated ferrule					
	Gauge	A3				
Rated current / Rated cross section		13.5 A / 1 mm²		7 A / 18 AWG	Torque	0.4 - 0.6 N.m 3.5 - 5.3 lb.in
Rated short-time withstand current (1s)		120 A				
Rated voltage		1000 V		600 V		
Impulse withstand voltage		8000 V				
Protection		IP20		NEMA 1		

The connecting capacity data for one Rigid: Solid/Stranded, or one Flexible conductor (when applicable) is a mandatory information required by IEC, UL and CSA standards (Copper conductors). All other data are provided as supplementary information only. For more details, please consult our CB, UL or CSA certificates and technical datasheet available on <http://www.TE.com>

RoHS	RoHS	cCSAus	Gost R
------	------	--------	--------

Accessories

Description	Color	Type	Part Number	Pkg pce	Weight (1 pce) g		
1 End stops	Dark grey	BAM4	1SNK900001R0000	50	14.00		
		BAZ1	1SNK900002R0000	50	5.30		
2 End sections	Grey	FEDAD1	1SNA199336R2000	20	2.50		
3 Jumper bars	Grey	2 poles	BJMI5-2	1SNA176278R1600	10	3.30	
		3 poles	BJMI5-3	1SNA176279R1700	10	5.00	
		4 poles	BJMI5-4	1SNA176280R0500	10	6.70	
		5 poles	BJMI5-5	1SNA176281R2200	10	8.40	
		10 poles	BJMI5-10	1SNA176282R2300	10	16.90	
4 Lateral jumper bars	Grey	2 poles	PC5-2	1SNA113542R1000	10	1.80	
		10 poles	PC5-10	1SNA113544R1200	10	6.00	
5 Insulating tips		For lateral jumper bars type PC...	EIP	1SNA113550R2400	10		
6 Circuit separators	Grey	0 mm	0 in	SCAD5	1SNA199551R2000	10	0.30
7 Shield connectors				CBM5	1SNA178745R1400	50	
8 Tools		Semi automatic tool		OUPAD	1SNA178944R0400	1	205.00
		Hand tool		OUMAD	1SNA179466R0600	1	29.00
9 Terminal block markers	White	Blank card	RC510	1SNA231000R0700	1	5.20	

Complete list of accessories is indicated in the terminal block datasheet.

Some accessories such as jumper bars may modify the terminal block's ratings: complete information in the accessories catalogue pages.

Ground IDC terminal blocks

Description	Color	Type	Part Number	Pkg pce	Weight (1 pce) g
Ground	Green-yellow	D2.5/5.P.ADO	1SNA399030R0500	50	9.00

Technical data valid for copper conductors only.

D4/6.ADO IDC terminal blocks

Feed-through ADO - screw clamp - 6 mm 0.236 in spacing

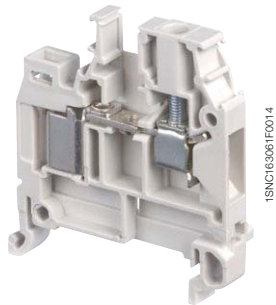

D4/6.ADO

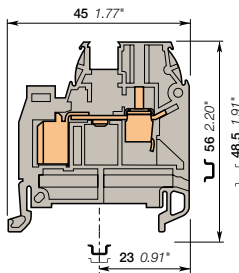

Description

- With the TE Connectivity ADO System®, experience the fastest and most reliable connection on the market,
- This solution brings all the benefits of the ADO System® and allows installators to connect on standard screw clamp,
- Up to 2 wires per connection in the ADO System® connection.

Ordering details

Description	Color	Type	Part Number	Pkg pce	Weight (1 pce) g
Feed-through	Grey <input type="checkbox"/>	D4/6.ADO	1SNA199034R1500	50	7.00
	Blue <input type="checkbox"/>	D4/6.N.ADO	1SNA199036R1700	50	7.00
	Orange <input type="checkbox"/>	D4/6.ADO	1SNA199035R1600	50	7.00

Main technical data

		IEC	UL	CSA	Mounting instructions	
ADO	Rigid: Solid/Stranded	0.34-1.5 mm²	22-16 AWG	22-16 AWG	Rail	TH 35-7.5, TH 35-15
	Flexible without ferrule	0.34-1.5 mm²			Wire stripping length	9.5 mm 0.37 in
Screw clamp	Rigid: Solid/Stranded	0.2-4 mm²	22-10 AWG	22-10 AWG	Tool	Flat screwdriver Ø 4 mm Ø 0.157 in
	Flexible without ferrule	0.22-4 mm²				
	Flexible with insulated ferrule				Torque	0.5 - 0.8 N.m 4.4 - 7.1 lb.in
	Gauge	A4				
Rated current / Rated cross section		17.5 A / 1.5 mm²	18 A / 16 AWG	18 A / 16 AWG		
Rated short-time withstand current (1s)		180 A				
Rated voltage		1000 V	600 V	600 V		
Impulse withstand voltage		8000 V				
Protection		IP20	NEMA 1			

The connecting capacity data for one Rigid: Solid/Stranded, or one Flexible conductor (when applicable) is a mandatory information required by IEC, UL and CSA standards (Copper conductors). All other data are provided as supplementary information only. For more details, please consult our CB, UL or CSA certificates and technical datasheet available on <http://www.TE.com>



6 mm 0.236 in spacing

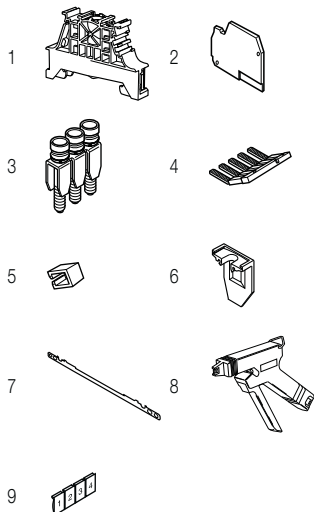

Accessories

Description	Color	Type	Part Number	Pkg pce	Weight (1 pce) g	
1 End stops	Dark grey <input type="checkbox"/>	BAM4	1SNK900001R0000	50	14.00	
		BAZ1	1SNK900002R0000	50	5.30	
2 End sections	Grey <input type="checkbox"/>	FEDAD1	1SNA199336R2000	20	2.50	
3 Jumper bars		2 poles 32 A	BJM16-2	1SNA176663R0000	10	4.40
		3 poles	BJM16-3	1SNA176664R0100	10	6.70
		4 poles	BJM16-4	1SNA176665R0200	10	8.90
		5 poles	BJM16-5	1SNA176666R0300	10	11.20
		10 poles	BJM16-10	1SNA176667R0400	10	22.40
4 Lateral jumper bars	Grey <input type="checkbox"/>	2 poles 35 A	PC6-2	1SNA113546R1400	10	2.00
		10 poles	PC6-10	1SNA113548R2600	10	8.00
5 Insulating tips		For lateral jumper bars type PC...	EIP	1SNA113550R2400	10	
6 Circuit separators	Grey <input type="checkbox"/>		SCAD	1SNA196896R0000	10	
7 Shield connectors			CBM5	1SNA178745R1400	50	
8 Tools		Semi automatic tool	OUPAD	1SNA178944R0400	1	205.00
		Hand tool	OUMAD	1SNA179466R0600	1	29.00
9 Terminal block markers	White <input type="checkbox"/>	Blank card	RC610	1SNA233000R0100	1	7.50

Complete list of accessories is indicated in the terminal block datasheet.

Some accessories such as jumper bars may modify the terminal block's ratings: complete information in the accessories catalogue pages.

Ground IDC terminal blocks

Description	Color	Type	Part Number	Pkg pce	Weight (1 pce) g
Ground	Green-yellow <input type="checkbox"/>	D4/6.P.ADO	1SNA199050R0100	50	11.00

Technical data valid for copper conductors only.

D4/6.ADO IDC terminal blocks

Feed-through ADO - screw clamp - 6 mm 0.236 in spacing

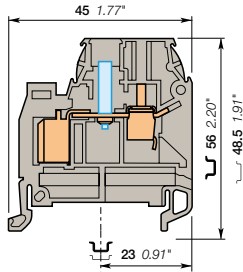

6 mm 0.236 in spacing



With test socket DIA 2 mm 0.079 in

Ordering details

Description	Color	Type	Part Number	Pkg pce	Weight (1 pce) g
Feed-through With test socket DIA 2 mm 0.079 in	Grey <input type="checkbox"/>	D4/6.ADO.2	1SNA199064R2300	50	8.00

Main technical data	IEC	UL	CSA	Nota
Rated voltage	800 V	600 V	600 V	
Impulse withstand voltage	8000 V			
Protection	IP20	NEMA 1		

The connecting capacity data for one Rigid: Solid/Stranded, or one Flexible conductor (when applicable) is a mandatory information required by IEC, UL and CSA standards (Copper conductors). All other data are provided as supplementary information only. For more details, please consult our CB, UL or CSA certificates and technical datasheet available on <http://www.TE.com>



Accessories

Description	Color	Type	Part Number	Pkg pce	Weight (1 pce) g
1 Test plugs DIA 2 mm 0.079 in	Black <input checked="" type="checkbox"/>	FC2	1SNA007865R2600	100	

With test socket DIA 4 mm 0.157 in

Ordering details

Description	Color	Type	Part Number	Pkg pce	Weight (1 pce) g
Feed-through With test socket DIA 4 mm 0.157 in	Grey <input type="checkbox"/>	D4/6.ADO.4	1SNA199048R0300	50	8.00

Main technical data	IEC	UL	CSA	Nota
Rated voltage	800 V	600 V	600 V	
Impulse withstand voltage	8000 V			
Protection	IP10	NEMA		

The connecting capacity data for one Rigid: Solid/Stranded, or one Flexible conductor (when applicable) is a mandatory information required by IEC, UL and CSA standards (Copper conductors). All other data are provided as supplementary information only. For more details, please consult our CB, UL or CSA certificates and technical datasheet available on <http://www.TE.com>



Accessories

Description	Color	Type	Part Number	Pkg pce	Weight (1 pce) g
1 Test plugs DIA 4 mm 0.157 in	White <input type="checkbox"/>	FC4	1SNA167860R0100	10	10.00

6 mm 0.236 in spacing



Technical data valid for copper conductors only.

D6/8.ADO IDC terminal blocks

Feed-through ADO - screw clamp - 8 mm 0.315 in spacing



D6/8.ADO

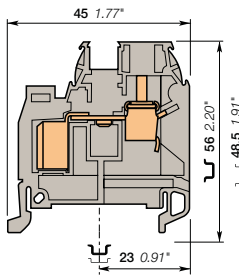

Description

- With the TE Connectivity ADO System®, experience the fastest and most reliable connection on the market,
- This solution brings all the benefits of the ADO System® and allows installators to connect on standard screw clamp,
- Up to 2 wires per connection in the ADO System® connection.

Ordering details

Description	Color	Type	Part Number	Pkg pce	Weight (1 pce) g
Feed-through With black marking for wire size 1-2.5 mm² (16-14 AWG)	Grey	D6/8.ADO	1SNA199042R2500	50	11.00
	Blue	D6/8.N.ADO	1SNA199044R2700	50	11.00
	Orange	D6/8.ADO	1SNA199043R2600	50	11.00

Main technical data

		IEC	UL	CSA	Mounting instructions	
ADO	Rigid: Solid/Stranded	1-2.5 mm²	16-14 AWG	16-14 AWG	Rail	TH 35-7.5, TH 35-15
	Flexible without ferrule	1-2.5 mm²			Wire stripping length	12 mm 0.47 in
Screw clamp	Rigid: Solid/Stranded	0.2-10 mm²	22-8 AWG	22-8 AWG	Tool	Flat screwdriver Ø 4 - 5 mm Ø 0.157 - 0.197 in
	Flexible without ferrule	0.22-6 mm²				
	Flexible with insulated ferrule				Torque	0.8 - 1 N.m 7.1 - 8.9 lb.in
Rated current / Rated cross section		24 A / 2.5 mm²	25 A / 14 AWG	25 A / 14 AWG		
Rated short-time withstand current (1s)		300 A				
Rated voltage		1000 V	600 V	600 V		
Impulse withstand voltage		8000 V				
Protection		IP20	NEMA 1			

The connecting capacity data for one Rigid: Solid/Stranded, or one Flexible conductor (when applicable) is a mandatory information required by IEC, UL and CSA standards (Copper conductors). All other data are provided as supplementary information only. For more details, please consult our CB, UL or CSA certificates and technical datasheet available on <http://www.TE.com>



8 mm 0.315 in spacing

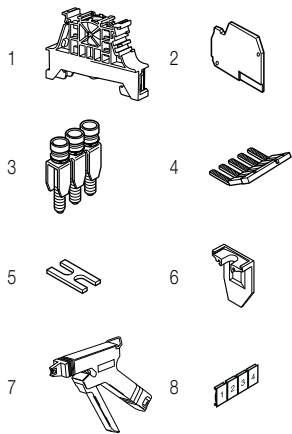

Accessories

Description	Color	Type	Part Number	Pkg pce	Weight (1 pce) g	
1 End stops	Dark grey	BAM4	1SNK900001R0000	50	14.00	
		BAZ1	1SNK900002R0000	50	5.30	
2 End sections	Grey	FEDAD1	1SNA199336R2000	20	2.50	
3 Jumper bars		2 poles	BJMI8-2	1SNA176669R1600	10	4.50
		3 poles	BJMI8-3	1SNA176670R1300	10	6.00
		4 poles	BJMI8-4	1SNA176671R0000	10	10.00
		5 poles	BJMI8-5	1SNA176672R0100	10	12.22
		10 poles	BJMI8-10	1SNA176673R0200	10	20.00
4 Lateral jumper bars		2 poles	PC8-2	1SNA116538R1700	10	3.00
		50 A	PC8-10	1SNA163313R2400	10	14.00
5 Cross spacing jumpers		5 mm 0.200 in - 6 mm 0.236 in - 8 mm 0.315 in	EL6	1SNA173627R2100	10	0.10
		Universal screw jumper bar kit N°I	BJDP1	1SNA179623R0300	10	7.00
		Universal screw jumper bar kit N°III	BJDP3	1SNA179625R0500	10	5.00
6 Circuit separators	Grey	SCAD	1SNA196896R0000	10		
7 Tools		Semi automatic tool	OUPAD	1SNA178944R0400	1	205.00
		Hand tool	OUMAD	1SNA179466R0600	1	29.00
8 Terminal block markers	White	RC810	1SNA234000R0200	1	8.20	

Complete list of accessories is indicated in the terminal block datasheet.

Some accessories such as jumper bars may modify the terminal block's ratings: complete information in the accessories catalogue pages.

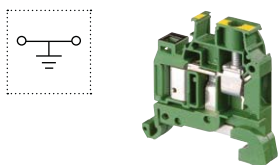

Ground IDC terminal blocks

Description	Color	Type	Part Number	Pkg pce	Weight (1 pce) g
Ground Profile aligned with D6/8.ADO	Green-yellow	D6/8.P.ADO	1SNA199118R2600	50	14.00

Technical data valid for copper conductors only.

D6/8.ADO IDC terminal blocks

Feed-through ADO - screw clamp - 8 mm 0.315 in spacing

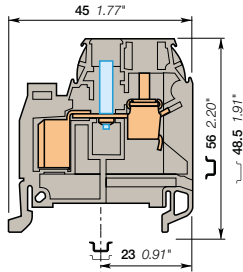

8 mm 0.315 in spacing



With test socket DIA 2 mm 0.079 in
Ordering details

Description	Color	Type	Part Number	Pkg pce	Weight (1 pce) g
Feed-through With test socket DIA 2 mm 0.079 in and black marking for wire size 1-2.5 mm ² (16-14 AWG)	Grey <input type="checkbox"/>	D6/8.ADO.2	1SNA199155R2300	50	12.00

Main technical data	IEC	UL	CSA	Nota
Rated voltage	1000 V	600 V	600 V	
Impulse withstand voltage	8000 V			
Protection	IP20	NEMA 1		

The connecting capacity data for one Rigid/ Solid/Stranded, or one Flexible conductor (when applicable) is a mandatory information required by IEC, UL and CSA standards (Copper conductors). All other data are provided as supplementary information only. For more details, please consult our CB, UL or CSA certificates and technical datasheet available on <http://www.TE.com>

RoHS	UL	CSA	Gost R
RoHS	UL	CSA	Gost R

Accessories

Description	Color	Type	Part Number	Pkg pce	Weight (1 pce) g
1 Test plugs DIA 2 mm 0.079 in	Black <input checked="" type="checkbox"/>	FC2	1SNA007865R2600	100	

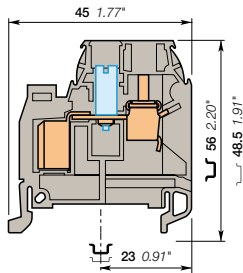

8 mm 0.315 in spacing



With test socket DIA 4 mm 0.157 in
Ordering details

Description	Color	Type	Part Number	Pkg pce	Weight (1 pce) g
Feed-through With test socket DIA 4 mm 0.157 in and black marking for wire size 1-2.5 mm ² (16-14 AWG)	Grey <input type="checkbox"/>	D6/8.ADO.4	1SNA199157R2500	50	12.00

Main technical data	IEC	UL	CSA	Nota
Rated voltage	800 V	600 V	600 V	
Impulse withstand voltage	8000 V			
Protection	IP10	NEMA		

The connecting capacity data for one Rigid/ Solid/Stranded, or one Flexible conductor (when applicable) is a mandatory information required by IEC, UL and CSA standards (Copper conductors). All other data are provided as supplementary information only. For more details, please consult our CB, UL or CSA certificates and technical datasheet available on <http://www.TE.com>

RoHS	UL	CSA	Gost R
RoHS	UL	CSA	Gost R

Accessories

Description	Color	Type	Part Number	Pkg pce	Weight (1 pce) g
1 Test plugs DIA 4 mm 0.157 in	White <input type="checkbox"/>	FC4	1SNA167860R0100	10	10.00

Technical data valid for copper conductors only.

D6/8.ADO IDC terminal blocks

Feed-through ADO - screw clamp - 8 mm 0.315 in spacing



D6/8.ADO

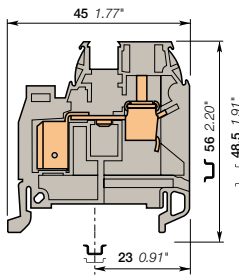

Description

- With the TE Connectivity ADO System®, experience the fastest and most reliable connection on the market,
- This solution brings all the benefits of the ADO System® and allows installators to connect on standard screw clamp.

Ordering details

Description	Color	Type	Part Number	Pkg pce	Weight (1 pce) g
Feed-through With white marking for wire size 4 mm ² (12 AWG)	Grey	D6/8.ADO3	1SNA399245R1500	50	11.00
	Blue	D6/8.N.ADO3	1SNA399319R1700	50	11.00
	Orange	D6/8.ADO3	1SNA399800R1700	50	11.00

Main technical data

		IEC	UL	CSA	Mounting instructions	
ADO	Rigid: Solid/Stranded	4 mm ²		12 AWG	Rail	TH 35-7.5, TH 35-15
	Flexible without ferrule	4 mm ²		12 AWG	Wire stripping length	12 mm 0.47 in
Screw clamp	Rigid: Solid/Stranded	0.2-10 mm ²		22-8 AWG	Tool	Flat screwdriver Ø 4 - 5 mm Ø 0.157 - 0.197 in
	Flexible without ferrule	0.22-6 mm ²				
	Flexible with insulated ferrule					
Gauge		A5			Torque	0.8 - 1 N.m 7.1 - 8.9 lb.in
Rated current / Rated cross section		32 A / 4 mm ²		25 A / 12 AWG		
Rated short-time withstand current (1s)		480 A				
Rated voltage		1000 V		600 V		
Impulse withstand voltage		8000 V				
Protection		IP20		NEMA 1		

The connecting capacity data for one Rigid: Solid/Stranded, or one Flexible conductor (when applicable) is a mandatory information required by IEC, UL and CSA standards (Copper conductors). All other data are provided as supplementary information only. For more details, please consult our CB, UL or CSA certificates and technical datasheet available on <http://www.TE.com>

RoHS	RoHS	RoHS	RoHS	RoHS	RoHS	RoHS	RoHS	RoHS	RoHS
------	------	------	------	------	------	------	------	------	------

8 mm 0.315 in spacing

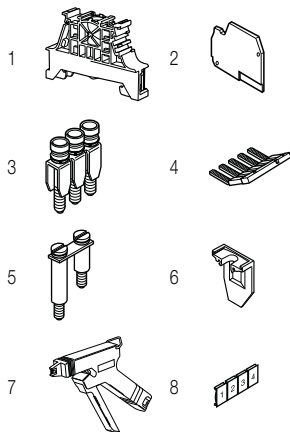

Accessories

Description	Color	Type	Part Number	Pkg pce	Weight (1 pce) g
1 End stops	Dark grey	BAM4	1SNK900001R0000	50	14.00
		BAZ1	1SNK900002R0000	50	5.30
2 End sections	Grey	FEDAD1	1SNA199336R2000	20	2.50
3 Jumper bars		BJMI8-2	1SNA176669R1600	10	4.50
		BJMI8-3	1SNA176670R1300	10	6.00
		BJMI8-4	1SNA176671R0000	10	10.00
		BJMI8-5	1SNA176672R0100	10	12.22
		BJMI8-10	1SNA176673R0200	10	20.00
4 Lateral jumper bars		PC8-2	1SNA116538R1700	10	3.00
		PC8-10	1SNA163313R2400	10	14.00
5 Cross spacing jumpers		BJDP1	1SNA179623R0300	10	7.00
		BJDP3	1SNA179625R0500	10	5.00
6 Circuit separators	Grey	SCAD	1SNA196896R0000	10	
7 Tools		OUPAD	1SNA178944R0400	1	205.00
		OUMAD	1SNA179466R0600	1	29.00
8 Terminal block markers	White	RC810	1SNA234000R0200	1	8.20

Complete list of accessories is indicated in the terminal block datasheet. Some accessories such as jumper bars may modify the terminal block's ratings: complete information in the accessories catalogue pages.

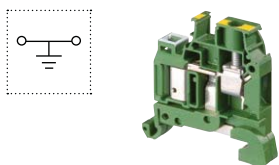

Ground IDC terminal blocks

Description	Color	Type	Part Number	Pkg pce	Weight (1 pce) g
Ground Profile aligned with D6/8 ADO	Green-yellow	D6/8.P.ADO3	1SNA399251R1300	50	14.00

Technical data valid for copper conductors only.

D2.5/5.P.ADO IDC terminal blocks

Ground ADO - screw clamp - 5 mm 0.197 in spacing

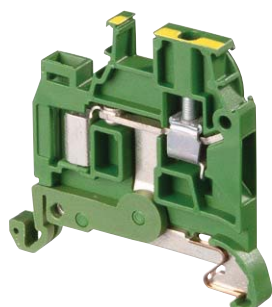

D2.5/5.P.ADO

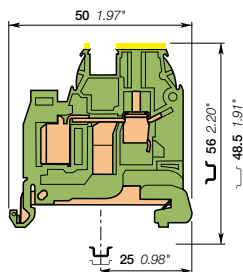

5 mm 0.197 in spacing

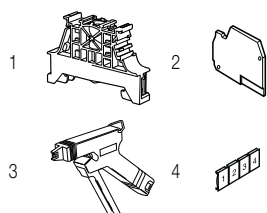

Description

- Protect your installation in the event of a short-circuit thanks to our screwless rail contact non operator dependent,
- Secure mounting or removal from the rail,
- This solution brings all the benefits of the ADO System® and allows installators to connect on standard screw clamp,
- Up to 2 wires per connection in the ADO System® connection.

Ordering details

Description	Color	Type	Part Number	Pkg pce	Weight (1 pce) g
Ground	Screwless rail connection	Green-yellow	D2.5/5.P.ADO	1SNA399030R0500	50 9.00

Main technical data

		IEC	UL	CSA	Mounting instructions	
ADO	Rigid: Solid/Stranded	0.2-1 mm²		24-18 AWG	Rail	TH 35-7.5, TH 35-15
	Flexible without ferrule	0.22-1 mm²			Wire stripping length	9.5 mm 0.37 in
Screw clamp	Rigid: Solid/Stranded	0.2-4 mm²		22-12 AWG	Tool	Flat screwdriver Ø 3.5 mm Ø 0.138 in
	Flexible without ferrule	0.22-2.5 mm²				
	Flexible with insulated ferrule					
	Gauge	A3				
Rated cross section		1 mm²		18 AWG	Torque	0.4 - 0.6 N.m 3.5 - 5.3 lb.in
Rated short-time withstand current (1s)		120 A				
Protection		IP20	NEMA 1			

The connecting capacity data for one Rigid: Solid/Stranded, or one Flexible conductor (when applicable) is a mandatory information required by IEC, UL and CSA standards (Copper conductors). All other data are provided as supplementary information only. For more details, please consult our CB, UL or CSA certificates and technical datasheet available on <http://www.TE.com>

RoHS	RoHS	cCSAus	Gost R

Accessories

Description	Color	Type	Part Number	Pkg pce	Weight (1 pce) g
1 End stops	Dark grey	BAM4	1SNK900001R0000	50	14.00
		BAZ1	1SNK900002R0000	50	5.30
2 End sections	Grey	FEDAD1	1SNA199336R2000	20	2.50
3 Tools		OUPAD	1SNA178944R0400	1	205.00
		OUMAD	1SNA179466R0600	1	29.00
4 Terminal block markers	White	RC510	1SNA231000R0700	1	5.20

Complete list of accessories is indicated in the terminal block datasheet.

Some accessories such as jumper bars may modify the terminal block's ratings: complete information in the accessories catalogue pages.

Technical data valid for copper conductors only.

D4/6.P.ADO IDC terminal blocks

Ground ADO - screw clamp - 6 mm 0.236 in spacing



1SN163064FC014

D4/6.P.ADO

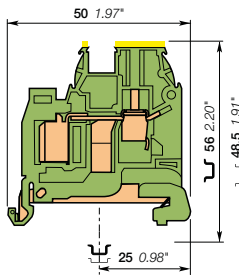

6 mm 0.236 in spacing

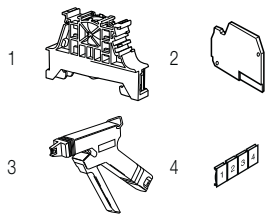

Description

- Protect your installation in the event of a short-circuit thanks to our screwless rail contact non operator dependent,
- Secure mounting or removal from the rail,
- This solution brings all the benefits of the ADO System® and allows installators to connect on standard screw clamp,
- Up to 2 wires per connection in the ADO System® connection.

Ordering details

Description	Color	Type	Part Number	Pkg pce	Weight (1 pce) g
Ground	Screwless rail connection: Green-yellow	D4/6.P.ADO	1SNA199050R0100	50	11.00

Main technical data

		IEC	UL	CSA
ADO	Rigid: Solid/Stranded	0.34-1.5 mm²	22-16 AWG	22-16 AWG
	Flexible without ferrule	0.34-1.5 mm²		
Screw clamp	Rigid: Solid/Stranded	0.2-4 mm²	22-10 AWG	22-10 AWG
	Flexible without ferrule	0.22-4 mm²		
	Flexible with insulated ferrule			
	Gauge	A4		
Rated cross section		1.5 mm²	16 AWG	16 AWG
Rated short-time withstand current (1s)		180 A		
Protection		IP20	NEMA 1	

Mounting instructions

Rail		TH 35-7.5, TH 35-15
Wire stripping length		9.5 mm 0.37 in
Tool		Flat screwdriver Ø 4 mm Ø 0.157 in
Torque		0.5 - 0.8 N.m 4.4 - 7.1 lb.in

The connecting capacity data for one Rigid: Solid/Stranded, or one Flexible conductor (when applicable) is a mandatory information required by IEC, UL and CSA standards (Copper conductors). All other data are provided as supplementary information only. For more details, please consult our CB, UL or CSA certificates and technical datasheet available on <http://www.TE.com>



Accessories

Description	Color	Type	Part Number	Pkg pce	Weight (1 pce) g	
1 End stops	Dark grey	BAM4	1SNK900001R0000	50	14.00	
		BAZ1	1SNK900002R0000	50	5.30	
2 End sections	Grey	FEDAD1	1SNA199336R2000	20	2.50	
3 Tools		Semi automatic tool	OUPAD	1SNA178944R0400	1	205.00
		Hand tool	OUMAD	1SNA179466R0600	1	29.00
4 Terminal block markers	White	RC610	1SNA233000R0100	1	7.50	

Complete list of accessories is indicated in the terminal block datasheet.

Some accessories such as jumper bars may modify the terminal block's ratings: complete information in the accessories catalogue pages.

Technical data valid for copper conductors only.

D6/8.P.ADO IDC terminal blocks

Ground ADO - screw clamp - 8 mm 0.315 in spacing

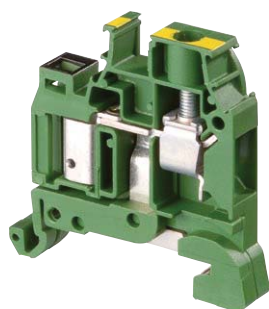

1SNIC163135F0014

D6/8.P.ADO

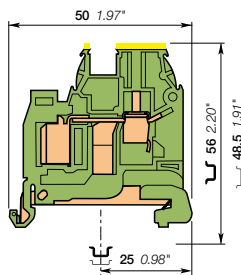

8 mm 0.315 in spacing

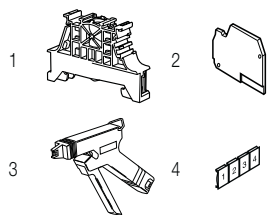

Description

- Protect your installation in the event of a short-circuit thanks to our screwless rail contact non operator dependent,
- Secure mounting or removal from the rail,
- This solution brings all the benefits of the ADO System® and allows installators to connect on standard screw clamp,
- Up to 2 wires per connection in the ADO System® connection.

Ordering details

Description	Color	Type	Part Number	Pkg pce	Weight (1 pce) g	
Ground	Screwless rail connection, with black marking for wire size 1-2.5 mm² (16-14 AWG)	Green-yellow	D6/8.P.ADO	1SNA199118R2600	50	14.00

Main technical data

		IEC	UL	CSA	
ADO	Rigid: Solid/Stranded Flexible without ferrule Flexible with ferrule	1-2.5 mm² 1-2.5 mm²	16-14 AWG	16-14 AWG	Rail
Screw clamp	Rigid: Solid/Stranded Flexible without ferrule Flexible with insulated ferrule Gauge	0.2-10 mm² 0.22-6 mm²	22-8 AWG	22-8 AWG	Wire stripping length
Rated cross section		2.5 mm²	14 AWG	14 AWG	Tool
Rated short-time withstand current (1s)		300 A			Torque
Protection		IP20	NEMA 1		

Mounting instructions

The connecting capacity data for one Rigid: Solid/Stranded, or one Flexible conductor (when applicable) is a mandatory information required by IEC, UL and CSA standards (Copper conductors). All other data are provided as supplementary information only. For more details, please consult our CB, UL or CSA certificates and technical datasheet available on <http://www.TE.com>



Accessories

Description	Color	Type	Part Number	Pkg pce	Weight (1 pce) g
1 End stops	Dark grey	BAM4	1SNK900001R0000	50	14.00
		BAZ1	1SNK900002R0000	50	5.30
2 End sections	Grey	FEDAD1	1SNA199336R2000	20	2.50
3 Tools		Semi automatic tool Hand tool	OUPAD OUMAD	1	205.00 29.00
4 Terminal block markers	White	RC810	1SNA234000R0200	1	8.20

Complete list of accessories is indicated in the terminal block datasheet.
Some accessories such as jumper bars may modify the terminal block's ratings: complete information in the accessories catalogue pages.

Technical data valid for copper conductors only.

D6/8.P.ADO IDC terminal blocks

Ground ADO - screw clamp - 8 mm 0.315 in spacing

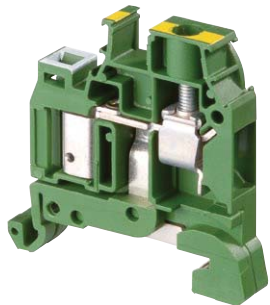

1SNK183101R0014

D6/8.P.ADO

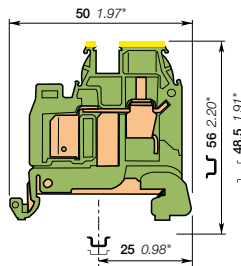

8 mm 0.315 in spacing

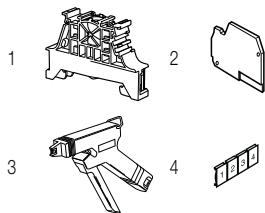

Description

- Protect your installation in the event of a short-circuit thanks to our screwless rail contact non operator dependent,
- Secure mounting or removal from the rail,
- This solution brings all the benefits of the ADO System® and allows installators to connect on standard screw clamp.

Ordering details

Description	Color	Type	Part Number	Pkg pce	Weight (1 pce) g
Ground Screwless rail connection, with white marking for wire size 4 mm² (12 AWG)	Green-yellow	D6/8.P.ADO3	1SNA399251R1300	50	14.00

Main technical data

		IEC	UL	CSA	Mounting instructions	
ADO	Rigid: Solid/Stranded	4 mm²		12 AWG	Rail	TH 35-7.5, TH 35-15
	Flexible without ferrule	4 mm²			Wire stripping length	12 mm 0.47 in
Screw clamp	Rigid: Solid/Stranded	0.2-10 mm²		22-8 AWG	Tool	Flat screwdriver Ø 4 - 5 mm Ø 0.157 - 0.197 in
	Flexible without ferrule	0.22-6 mm²				
	Flexible with insulated ferrule				Torque	0.8 - 1 N.m 7.1 - 8.9 lb.in
Gauge		A5				
Rated cross section		4 mm²		12 AWG		
Rated short-time withstand current (1s)		480 A				
Protection		IP20	NEMA 1			

The connecting capacity data for one Rigid: Solid/Stranded, or one Flexible conductor (when applicable) is a mandatory information required by IEC, UL and CSA standards (Copper conductors). All other data are provided as supplementary information only. For more details, please consult our CB, UL or CSA certificates and technical datasheet available on <http://www.TE.com>

RoHS	RoHS	cCSAus	Gost R						
------	------	--------	--------	--	--	--	--	--	--

Accessories

Description	Color	Type	Part Number	Pkg pce	Weight (1 pce) g
1 End stops	Dark grey	BAM4	1SNK900001R0000	50	14.00
		BAZ1	1SNK900002R0000	50	5.30
2 End sections	Grey	FEDAD1	1SNA199336R2000	20	2.50
3 Tools		OUPAD	1SNA178944R0400	1	205.00
		OUMAD	1SNA179466R0600	1	29.00
4 Terminal block markers	White	RC810	1SNA234000R0200	1	8.20

Complete list of accessories is indicated in the terminal block datasheet.

Some accessories such as jumper bars may modify the terminal block's ratings: complete information in the accessories catalogue pages.

Technical data valid for copper conductors only.

D4/6.D2.ADO IDC terminal blocks

Double deck ADO - screw clamp - 6 mm 0.236 in spacing



D4/6.D2.ADO

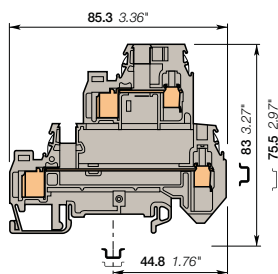

6 mm 0.236 in spacing

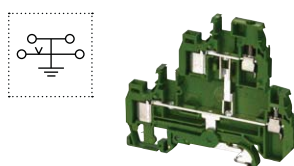
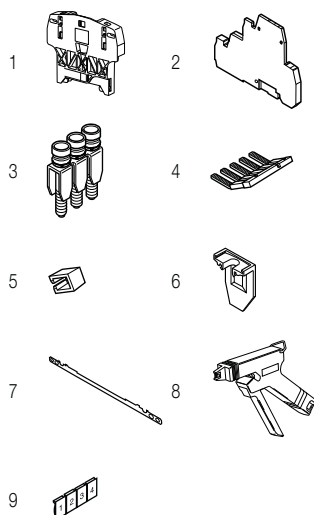

Description

- Save space with 2 decks terminal block,
- With the TE Connectivity ADO System®, experience the fastest and most reliable connection on the market,
- This solution brings all the benefits of the ADO System® and allows installators to connect on standard screw clamp,
- Up to 2 wires per connection in the ADO System® connection.

Ordering details

Description	Color	Type	Part Number	Pkg pce	Weight (1 pce) g
Feed-through With 2 feed-through circuits	Grey	D4/6.D2.ADO	1SNA199242R0200	50	18.00
	Blue	D4/6.D2.N.ADO	1SNA199244R0400	50	18.00

Main technical data

		IEC	UL	CSA	Mounting instructions	
ADO	Rigid: Solid/Stranded	0.28-1.5 mm²		22-16 AWG	Rail	TH 35-7.5, TH 35-15
	Flexible without ferrule	0.34-1.5 mm²			Wire stripping length	9.5 mm 0.37 in
Screw clamp	Rigid: Solid/Stranded	0.2-4 mm²		22-10 AWG	Tool	Flat screwdriver Ø 4 mm Ø 0.157 in
	Flexible without ferrule	0.22-4 mm²				
	Flexible with insulated ferrule					
	Gauge	A4				
Rated current / Rated cross section		17.5 A / 1.5 mm²		18 A / 16 AWG	Torque	0.5 - 0.8 N.m 4.4 - 7.1 lb.in
Rated short-time withstand current (1s)		180 A				
Rated voltage		800 V		600 V		
Impulse withstand voltage		6000 V				
Protection		IP20		NEMA 1		

The connecting capacity data for one Rigid: Solid/Stranded, or one Flexible conductor (when applicable) is a mandatory information required by IEC, UL and CSA standards (Copper conductors). All other data are provided as supplementary information only. For more details, please consult our CB, UL or CSA certificates and technical datasheet available on <http://www.TE.com>

RoHS	RoHS	CSAus	PC	Gost R
------	------	-------	----	--------

Accessories

Description	Color	Type	Part Number	Pkg pce	Weight (1 pce) g
1 End stops 10 mm 0.394 in	Dark grey	BAZH1	1SNK900102R0000	20	24.00
2 End sections 5 mm 0.197 in	Grey	FED2AD1	1SNA199417R1200	20	6.60
3 Jumper bars 2 poles 32 A		BJM16-2	1SNA176663R0000	10	4.40
		BJM16-3	1SNA176664R0100	10	6.70
		BJM16-4	1SNA176665R0200	10	8.90
		BJM16-5	1SNA176666R0300	10	11.20
		BJM16-10	1SNA176667R0400	10	22.40
4 Lateral jumper bars 2 poles 35 A	Grey	PC6-2	1SNA113546R1400	10	2.00
		PC6-10	1SNA113548R2600	10	8.00
5 Insulating tips For lateral jumper bars type PC...		EIP	1SNA113550R2400	10	
6 Circuit separators 0 mm 0 in	Grey	SCAD	1SNA196896R0000	10	
7 Shield connectors		CBD2S	1SNA178408R1400	50	
8 Tools		OUPAD	1SNA178944R0400	1	205.00
		OUMAD	1SNA179466R0600	1	29.00
9 Terminal block markers Blank card	White	RC610	1SNA233000R0100	1	7.50

Complete list of accessories is indicated in the terminal block datasheet.

Some accessories such as jumper bars may modify the terminal block's ratings: complete information in the accessories catalogue pages.

Ground

Description	Color	Type	Part Number	Pkg pce	Weight (1 pce) g
Ground Profile aligned with D4/6.D2 ADO	Green-yellow	D4/6.D1.P.ADO	1SNA399931R2500	50	23.00

Technical data valid for copper conductors only.

2

1SNC163007S0201 - Rev. A

D6/8.D2.ADO IDC terminal blocks

Double deck ADO - screw clamp - 8 mm 0.315 in spacing



D6/8.D2.ADO

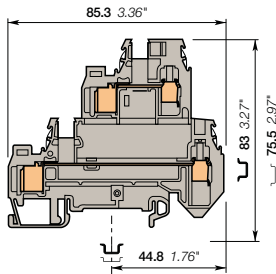

Description

- Save space with 2 decks terminal block,
- With the TE Connectivity ADO System®, experience the fastest and most reliable connection on the market,
- This solution brings all the benefits of the ADO System® and allows installators to connect on standard screw clamp,
- Up to 2 wires per connection in the ADO System® connection.

Ordering details

Description	Color	Type	Part Number	Pkg pce	Weight (1 pce) g
Feed-through With 2 feed-through circuits	Grey <input type="checkbox"/>	D6/8.D2.ADO	1SNA399600R2600	50	

Main technical data

		IEC	UL	CSA	Mounting instructions	
ADO	Rigid: Solid/Stranded	1-2.5 mm²			Rail	TH 35-7.5, TH 35-15
	Flexible without ferrule	1-2.5 mm²			Wire stripping length	12 mm 0.47 in
Screw clamp	Rigid: Solid/Stranded	0.2-10 mm²			Tool	Flat screwdriver Ø 4-4.5 mm Ø 0.157 - 0.177 in
	Flexible without ferrule	0.22-6 mm²				
	Flexible with insulated ferrule					
Gauge		A5			Torque	0.8 - 1 N.m 7.1 - 8.9 lb.in
Rated current / Rated cross section		24 A / 2.5 mm²				
Rated short-time withstand current (1s)		300 A				
Rated voltage		800 V				
Impulse withstand voltage		8000 V				
Protection		IP20	NEMA 1			

The connecting capacity data for one Rigid: Solid/Stranded, or one Flexible conductor (when applicable) is a mandatory information required by IEC, UL and CSA standards (Copper conductors). All other data are provided as supplementary information only. For more details, please consult our CB, UL or CSA certificates and technical datasheet available on <http://www.TE.com>

RoHS <input type="checkbox"/>	Gost R <input type="checkbox"/>
-------------------------------	---------------------------------

8 mm 0.315 in spacing

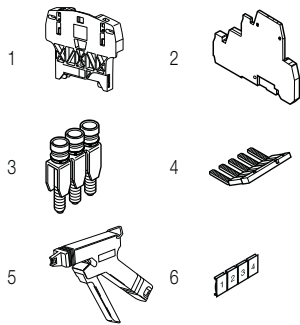

Accessories

Description	Color	Type	Part Number	Pkg pce	Weight (1 pce) g	
1 End stops 10 mm 0.394 in	Dark grey <input type="checkbox"/>	BAZH1	1SNK900102R0000	20	24.00	
2 End sections 5 mm 0.197 in	Grey <input type="checkbox"/>	FED2AD1	1SNA199417R1200	20	6.60	
3 Jumper bars		2 poles 41 A	BJM18-2	1SNA176669R1600	10	4.50
		3 poles	BJM18-3	1SNA176670R1300	10	6.00
		4 poles	BJM18-4	1SNA176671R0000	10	10.00
		5 poles	BJM18-5	1SNA176672R0100	10	12.22
		10 poles	BJM18-10	1SNA176673R0200	10	20.00
4 Lateral jumper bars	Grey <input type="checkbox"/>	2 poles 50 A	PC8-2	1SNA116538R1700	10	3.00
		10 poles	PC8-10	1SNA163313R2400	10	
5 Tools		Semi automatic tool	OUPAD	1SNA178944R0400	1	205.00
		Hand tool	OUMAD	1SNA179466R0600	1	29.00
6 Terminal block markers	White <input type="checkbox"/>	RC810	1SNA234000R0200	1	8.20	

Complete list of accessories is indicated in the terminal block datasheet.

Some accessories such as jumper bars may modify the terminal block's ratings: complete information in the accessories catalogue pages.

Technical data valid for copper conductors only.

D2.5/5.SN.ADO IDC terminal blocks

Disconnect with blade - with test socket - ADO screw clamp 5 mm 0.197 in spacing

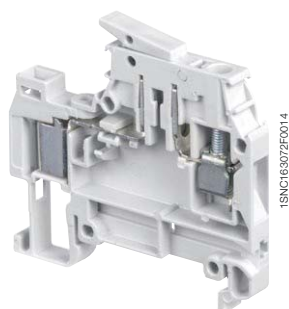

D2.5/5.SN.ADO

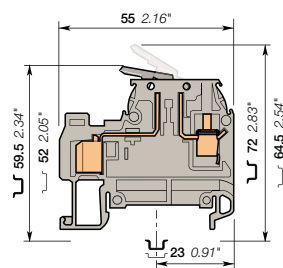

5 mm 0.197 in spacing

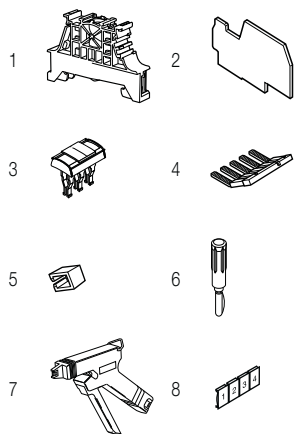

Description

- Ease your disconnect operations with the disconnect knife blade operated by hand,
- With the TE Connectivity ADO System®, experience the fastest and most reliable connection on the market,
- This solution brings all the benefits of the ADO System® and allows installators to connect on standard screw clamp,
- Up to 2 wires per connection in the ADO System® connection.

Ordering details

Description	Color	Type	Part Number	Pkg pce	Weight (1 pce) g
Disconnect With test socket DIA 2 mm 0.079 in on the ADO side	Grey <input type="checkbox"/>	D2.5/5.SN.ADO	1SNA399226R0200	50	9.00

Main technical data

	IEC	UL	CSA	Mounting instructions	
ADO	Rigid: Solid/Stranded Flexible without ferrule Flexible with ferrule	0.2-1 mm² 0.22-1 mm²		Rail	TH 35-7.5, TH 35-15
Screw clamp	Rigid: Solid/Stranded Flexible without ferrule Flexible with insulated ferrule Gauge	0.2-4 mm² 0.22-2.5 mm² A3		Wire stripping length	9.5 mm 0.37 in
Rated current / Rated cross section		10 A / 1 mm²		Tool	Flat screwdriver Ø 3.5 mm Ø 0.138 in
Rated short-time withstand current (1s)		120 A		Torque	0.4 - 0.6 N.m 3.5 - 5.3 lb.in
Rated voltage		320 V			
Impulse withstand voltage		4000 V			
Protection		IP20	NEMA 1		

The connecting capacity data for one Rigid: Solid/Stranded, or one Flexible conductor (when applicable) is a mandatory information required by IEC, UL and CSA standards (Copper conductors). All other data are provided as supplementary information only. For more details, please consult our CB, UL or CSA certificates and technical datasheet available on <http://www.TE.com>



Accessories

Description	Color	Type	Part Number	Pkg pce	Weight (1 pce) g
1 End stops	Dark grey <input type="checkbox"/>	BAM4	1SNK900001R0000	50	14.00
		BAZ1	1SNK900002R0000	50	5.30
2 End sections	Grey <input type="checkbox"/>	FEDAD4	1SNA199352R0000	20	2.30
3 Jumper bars	Orange <input type="checkbox"/>	BJADO5-2	1SNA205955R0300	20	1.00
		BJADO5-3	1SNA205956R0400	20	1.00
		BJADO5-5	1SNA205958R1600	20	2.00
		BJADO5-10	1SNA205963R0300	10	5.00
4 Lateral jumper bars	Grey <input type="checkbox"/>	PC5-2	1SNA113542R1000	10	1.80
		PC5-10	1SNA113544R1200	10	6.00
5 Insulating tips		EIP	1SNA113550R2400	10	
6 Test plugs	Black <input type="checkbox"/>	FC2	1SNA007865R2600	100	
7 Tools		OUPAD	1SNA178944R0400	1	205.00
		OUMAD	1SNA179466R0600	1	29.00
8 Terminal block markers	White <input type="checkbox"/>	RC510	1SNA231000R0700	1	5.20

Complete list of accessories is indicated in the terminal block datasheet.

Some accessories such as jumper bars may modify the terminal block's ratings: complete information in the accessories catalogue pages.

Technical data valid for copper conductors only.

D2.5/5.SN.ADO IDC terminal blocks

Disconnect with blade - with test socket - ADO screw clamp 5 mm 0.197 in spacing



1 mm²

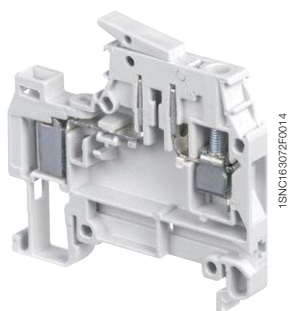

1SNC163072FC014

D2.5/5.SN.ADO

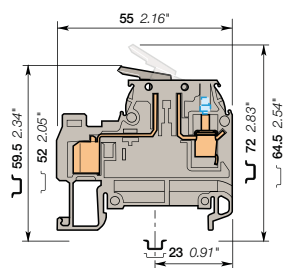

5 mm 0.197 in spacing

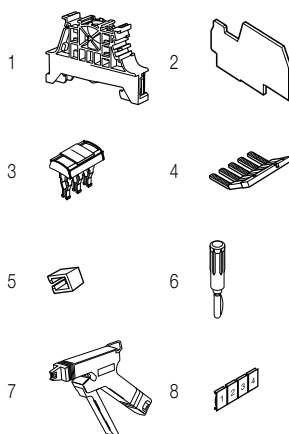

Description

- Ease your disconnect operations with the disconnect knife blade operated by hand,
- With the TE Connectivity ADO System®, experience the fastest and most reliable connection on the market,
- This solution brings all the benefits of the ADO System® and allows installators to connect on standard screw clamp,
- Up to 2 wires per connection in the ADO System® connection.

Ordering details

Description	Color	Type	Part Number	Pkg pce	Weight (1 pce) g
Disconnect With 2 test sockets DIA 2 mm 0.079 in	Grey <input type="checkbox"/>	D2.5/5.SNT2.ADO	1SNA399228R1400	50	9.00

Main technical data

		IEC	UL	CSA	Mounting instructions	
ADO	Rigid: Solid/Stranded Flexible without ferrule	0.2-1 mm ² 0.22-1 mm ²			Rail	TH 35-7.5, TH 35-15
Screw clamp	Rigid: Solid/Stranded Flexible without ferrule Flexible with insulated ferrule Gauge	0.2-4 mm ² 0.22-2.5 mm ² A3			Wire stripping length	9.5 mm 0.37 in
Rated current / Rated cross section		10 A / 1 mm ²			Tool	Flat screwdriver Ø 3.5 mm Ø 0.138 in
Rated short-time withstand current (1s)		120 A			Torque	0.4 - 0.6 N.m 3.5 - 5.3 lb.in
Rated voltage		320 V				
Impulse withstand voltage		4000 V				
Protection		IP20	NEMA 1			

The connecting capacity data for one Rigid: Solid/Stranded, or one Flexible conductor (when applicable is a mandatory information required by IEC, UL and CSA standards (Copper conductors). All other data are provided as supplementary information only. For more details, please consult our CB, UL or CSA certificates and technical datasheet available on <http://www.TE.com>

RoHS
RoHS

PC
Gost R

Accessories

Description	Color	Type	Part Number	Pkg pce	Weight (1 pce) g
1 End stops	Dark grey <input type="checkbox"/>	BAM4	1SNK900001R0000	50	14.00
		BAZ1	1SNK900002R0000	50	5.30
2 End sections	Grey <input type="checkbox"/>	FEDAD4	1SNA199352R0000	20	2.30
3 Jumper bars	Orange <input type="checkbox"/>	BJADO5-2	1SNA205955R0300	20	1.00
		BJADO5-3	1SNA205956R0400	20	1.00
		BJADO5-10	1SNA205963R0300	10	5.00
4 Lateral jumper bars	Grey <input type="checkbox"/>	PC5-2	1SNA113542R1000	10	1.80
		PC5-10	1SNA113544R1200	10	6.00
5 Insulating tips		EIP	1SNA113550R2400	10	
6 Test plugs	Black <input type="checkbox"/>	FC2	1SNA007865R2600	100	
7 Tools		OUPAD	1SNA178944R0400	1	205.00
		OUMAD	1SNA179466R0600	1	29.00
8 Terminal block markers	White <input type="checkbox"/>	RC510	1SNA231000R0700	1	5.20

Complete list of accessories is indicated in the terminal block datasheet.

Some accessories such as jumper bars may modify the terminal block's ratings: complete information in the accessories catalogue pages.

Technical data valid for copper conductors only.

D4/6.SN.ADO IDC terminal blocks

Disconnect with blade - with test socket - ADO screw clamp 6 mm 0.236 in spacing

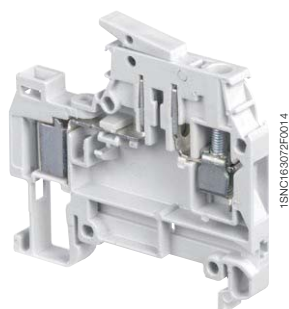

D4/6.SN.ADO

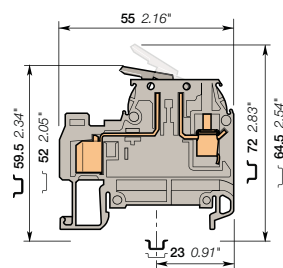

6 mm 0.236 in spacing

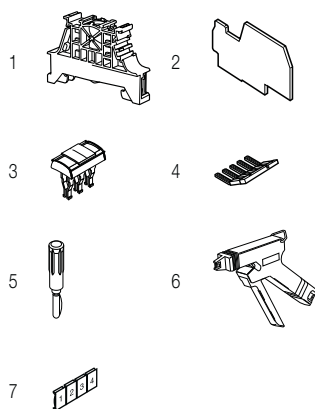

Description

- Ease your disconnect operations with the disconnect knife blade operated by hand,
- With the TE Connectivity ADO System®, experience the fastest and most reliable connection on the market,
- This solution brings all the benefits of the ADO System® and allows installators to connect on standard screw clamp,
- Up to 2 wires per connection in the ADO System® connection.

Ordering details

Description	Color	Type	Part Number	Pkg pce	Weight (1 pce) g
Disconnect With test socket DIA 2 mm 0.079 in on the ADO side	Grey <input type="checkbox"/>	D4/6.SN.ADO	1SNA199107R2400	50	9.00
	Orange <input type="checkbox"/>	D4/6.SN.ADO	1SNA199108R0500	50	9.00

Main technical data

		IEC	UL	CSA	Mounting instructions
ADO	Rigid: Solid/Stranded Flexible without ferrule Flexible with ferrule	0.34-1.5 mm ² 0.34-1.5 mm ²	22-16 AWG	22-16 AWG	Rail TH 35-7.5, TH 35-15 Wire stripping length 9.5 mm 0.37 in
Screw clamp	Rigid: Solid/Stranded Flexible without ferrule Flexible with insulated ferrule Gauge	0.2-4 mm ² 0.22-4 mm ² A4	22-10 AWG	22-10 AWG	Tool Flat screwdriver Ø 4 mm Ø 0.157 in
Rated current / Rated cross section		10 A / 1.5 mm ²	10 A / 16 AWG	15 A / 16 AWG	Torque 0.5 - 0.8 N.m 4.4 - 7.1 lb.in
Rated short-time withstand current (1s)		180 A			
Rated voltage		500 V	600 V	600 V	
Impulse withstand voltage		6000 V			
Protection		IP20	NEMA 1		

The connecting capacity data for one Rigid: Solid/Stranded, or one Flexible conductor (when applicable) is a mandatory information required by IEC, UL and CSA standards (Copper conductors). All other data are provided as supplementary information only. For more details, please consult our CB, UL or CSA certificates and technical datasheet available on <http://www.TE.com>



Accessories

Description	Color	Type	Part Number	Pkg pce	Weight (1 pce) g	
1 End stops	Dark grey <input type="checkbox"/>	BAM4	1SNK900001R0000	50	14.00	
		BAZ1	1SNK900002R0000	50	5.30	
2 End sections	Grey <input type="checkbox"/>	FEDAD4	1SNA199352R0000	20	2.30	
3 Jumper bars	Orange <input type="checkbox"/>	2 poles	BJADO6-2	1SNA205974R0600	20	1.00
		3 poles	BJADO6-3	1SNA205975R0700	20	1.00
		10 poles	BJADO6-10	1SNA205982R2700	10	6.00
		10 poles	PC61-10	1SNA163311R2200	10	5.00
4 Lateral jumper bars						
5 Test plugs	Black <input type="checkbox"/>	FC2	1SNA007865R2600	100		
6 Tools		OUPAD	1SNA178944R0400	1	205.00	
		OUMAD	1SNA179466R0600	1	29.00	
7 Terminal block markers	White <input type="checkbox"/>	RC610	1SNA233000R0100	1	7.50	

Complete list of accessories is indicated in the terminal block datasheet.

Some accessories such as jumper bars may modify the terminal block's ratings: complete information in the accessories catalogue pages.

Technical data valid for copper conductors only.

D4/6.SNT2.ADO IDC terminal blocks

Disconnect with blade - with test socket - ADO screw clamp 6 mm 0.236 in spacing



D4/6.SNT2.ADO

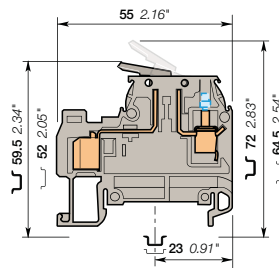

6 mm 0.236 in spacing

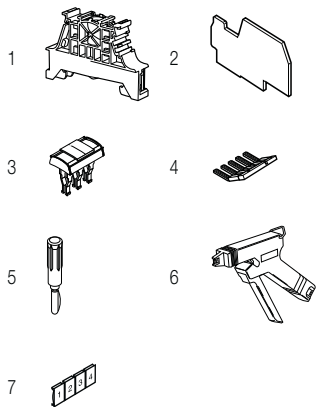

Description

- Ease your disconnect operations with the disconnect knife blade operated by hand,
- With the TE Connectivity ADO System®, experience the fastest and most reliable connection on the market,
- This solution brings all the benefits of the ADO System® and allows installators to connect on standard screw clamp,
- Up to 2 wires per connection in the ADO System® connection.

Ordering details

Description	Color	Type	Part Number	Pkg	Weight
Disconnect With 2 test sockets DIA 2 mm 0.079 in	Grey <input type="checkbox"/>	D4/6.SNT2.ADO	1SNA199235R2300	50 pce	9.00 (1 pce) g

Main technical data

		IEC	UL	CSA	Mounting instructions	
ADO	Rigid: Solid/Stranded Flexible without ferrule	0.34-1.5 mm ² 0.34-1.5 mm ²	22-16 AWG	22-16 AWG	Rail	TH 35-7.5, TH 35-15
Screw clamp	Rigid: Solid/Stranded Flexible without ferrule	0.2-4 mm ² 0.22-4 mm ²	22-10 AWG	22-10 AWG	Wire stripping length	9.5 mm 0.37 in
	Flexible with insulated ferrule Gauge	A4			Tool	Flat screwdriver Ø 4 mm Ø 0.157 in
Rated current / Rated cross section		10 A / 1.5 mm ²	10 A / 16 AWG	15 A / 16 AWG	Torque	0.5 - 0.8 N.m 4.4 - 7.1 lb.in
Rated short-time withstand current (1s)		180 A				
Rated voltage		500 V	600 V	600 V		
Impulse withstand voltage		6000 V				
Protection		IP20	NEMA 1			

The connecting capacity data for one Rigid: Solid/Stranded, or one Flexible conductor (when applicable) is a mandatory information required by IEC, UL and CSA standards (Copper conductors). All other data are provided as supplementary information only. For more details, please consult our CB, UL or CSA certificates and technical datasheet available on <http://www.TE.com>

RoHS		RoHS	USR CNR		cCSAus		Gost R
------	--	------	---------	--	--------	--	--------

Accessories

Description	Color	Type	Part Number	Pkg	Weight	
1 End stops	Dark grey <input type="checkbox"/>	BAM4	1SNK900001R0000	50 pce	14.00 (1 pce) g	
2 End sections	Grey <input type="checkbox"/>	BAZ1	1SNK900002R0000	50	5.30	
3 Jumper bars	Orange <input type="checkbox"/>	2 poles	BJADO6-2	1SNA205974R0600	20	1.00
		3 poles	BJADO6-3	1SNA205975R0700	20	1.00
		10 poles	BJADO6-10	1SNA205982R2700	10	6.00
4 Lateral jumper bars		PC61-10	1SNA163311R2200	10	5.00	
5 Test plugs	Black <input type="checkbox"/>	FC2	1SNA007865R2600	100		
6 Tools		OUPAD	1SNA178944R0400	1	205.00	
		OUMAD	1SNA179466R0600	1	29.00	
7 Terminal block markers	White <input type="checkbox"/>	RC610	1SNA233000R0100	1	7.50	

Complete list of accessories is indicated in the terminal block datasheet.

Some accessories such as jumper bars may modify the terminal block's ratings: complete information in the accessories catalogue pages.

Technical data valid for copper conductors only.

D4/8.SN.ADO IDC terminal blocks

Disconnect with blade - with test socket - ADO screw clamp 8 mm 0.315 in spacing

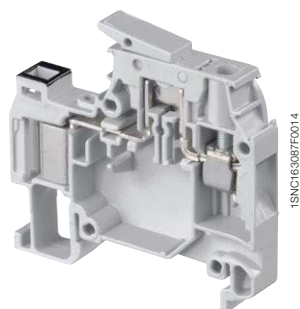

D4/8.SN.ADO

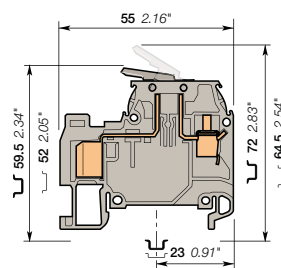

8 mm 0.315 in spacing

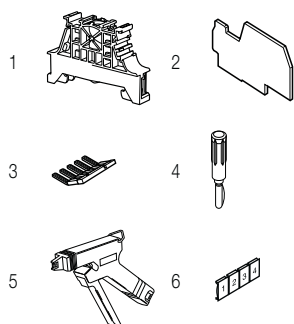

Description

- Ease your disconnect operations with the disconnect knife blade operated by hand,
- With the TE Connectivity ADO System®, experience the fastest and most reliable connection on the market,
- This solution brings all the benefits of the ADO System® and allows installators to connect on standard screw clamp,
- Up to 2 wires per connection in the ADO System® connection.

Ordering details

Description	Color	Type	Part Number	Pkg pce	Weight (1 pce) g
Disconnect With test socket DIA 2 mm 0.079 in on the ADO side, with black marking for wire size 1-2.5 mm² (16-14 AWG)	Grey <input type="checkbox"/>	D4/8.SN.ADO	1SNA199137R1100	50	11.00

Main technical data

		IEC	UL	CSA		
ADO	Rigid: Solid/Stranded Flexible without ferrule Flexible with ferrule	1-2.5 mm² 1-2.5 mm²	22-16 AWG	22-16 AWG	Rail	TH 35-7.5, TH 35-15
Screw clamp	Rigid: Solid/Stranded Flexible without ferrule Flexible with insulated ferrule Gauge	0.2-6 mm² 0.22-4 mm² A4	22-10 AWG	22-10 AWG	Wire stripping length	9.5 mm 0.37 in
Rated current / Rated cross section		15 A / 2.5 mm²	15 A / 16 AWG	15 A / 16 AWG	Tool	Flat screwdriver Ø 4 mm Ø 0.157 in
Rated short-time withstand current (1s)		300 A			Torque	0.5 - 0.8 N.m 4.4 - 7.1 lb.in
Rated voltage		500 V	600 V	600 V		
Impulse withstand voltage		6000 V				
Protection		IP20	NEMA 1			

The connecting capacity data for one Rigid: Solid/Stranded, or one Flexible conductor (when applicable) is a mandatory information required by IEC, UL and CSA standards (Copper conductors). All other data are provided as supplementary information only. For more details, please consult our CB, UL or CSA certificates and technical datasheet available on <http://www.TE.com>

RoHS	UL	CSA	Gost R
RoHS	UL	CSA	Gost R

Accessories

Description	Color	Type	Part Number	Pkg pce	Weight (1 pce) g
1 End stops	Dark grey <input type="checkbox"/>	BAM4	1SNK900001R0000	50	14.00
		BAZ1	1SNK900002R0000	50	5.30
2 End sections	Grey <input type="checkbox"/>	FEDAD4	1SNA199352R0000	20	2.30
3 Lateral jumper bars		PC81-10	1SNA173523R1100	10	5.00
4 Test plugs	Black <input type="checkbox"/>	FC2	1SNA007865R2600	100	
5 Tools		OUPAD	1SNA178944R0400	1	205.00
		OUMAD	1SNA179466R0600	1	29.00
6 Terminal block markers	White <input type="checkbox"/>	RC810	1SNA234000R0200	1	8.20

Complete list of accessories is indicated in the terminal block datasheet. Some accessories such as jumper bars may modify the terminal block's ratings: complete information in the accessories catalogue pages.

Technical data valid for copper conductors only.

D4/8.SF.I.ADO IDC terminal blocks

For 5 x 20 and 5 x 25 fuses - with test socket ADO - screw clamp 8 mm 0.315 in spacing



1.5 mm²

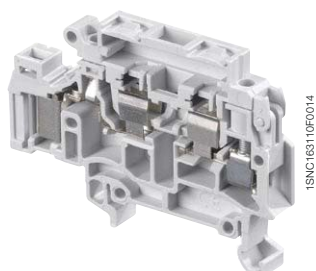

1SNK163110F0014

D4/8.SF.I.ADO

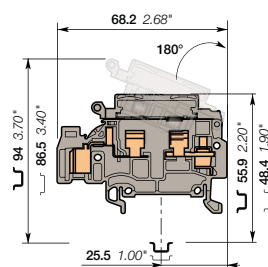

8 mm 0.315 in spacing

Description

- Protect your circuits with 5 x 20 and 5x 25 fuse terminal blocks (fuse not delivered with the terminal blocks),
- With the TE Connectivity ADO System®, experience the fastest and most reliable connection on the market,
- This solution brings all the benefits of the ADO System® and allows installators to connect on standard screw clamp,
- Up to 2 wires per connection in the ADO System® connection.

Ordering details

Description	Color	Type	Part Number	Pkg pce	Weight (1 pce) g
Fuse With test socket DIA 2 mm 0.079 in on the ADO side	Grey <input type="checkbox"/>	D4/8.SF.I.ADO	1SNA399785R0300	50	13.00

Main technical data

		IEC	UL	CSA	Mounting instructions	
ADO	Rigid: Solid/Stranded Flexible without ferrule	0.34-1.5 mm ² 0.34-1.5 mm ²			Rail	TH 35-7.5, TH 35-15
Screw clamp	Rigid: Solid/Stranded Flexible without ferrule Flexible with insulated ferrule Gauge	0.2-4 mm ² 0.22-4 mm ² A4			Wire stripping length	9.5 mm 0.37 in
Rated current / Rated cross section		6.3 A / 1.5 mm ²			Tool	Flat screwdriver Ø 4 mm Ø 0.157 in
Rated short-time withstand current (1s)		180 A			Torque	0.5 - 0.8 N.m 4.4 - 7.1 lb.in
Rated voltage		630 V				
Impulse withstand voltage		8000 V				
Protection		IP20	NEMA 1			

The connecting capacity data for one Rigid: Solid/Stranded, or one Flexible conductor (when applicable) is a mandatory information required by IEC, UL and CSA standards (Copper conductors). All other data are provided as supplementary information only. For more details, please consult our CB, UL or CSA certificates and technical datasheet available on <http://www.TE.com>

RoHS	RoHS	Gost R				
------	------	--------	--	--	--	--

Accessories

Description	Color	Type	Part Number	Pkg pce	Weight (1 pce) g
1 End stops	Dark grey <input type="checkbox"/>	BAM4	1SNK900001R0000	50	14.00
		BAZ1	1SNK900002R0000	50	5.30
2 End sections	Grey <input type="checkbox"/>	FEDAD10	1SNA399758R2700	20	3.00
3 Lateral jumper bars		PC81-10	1SNA173523R1100	10	5.00
4 Test plugs	Black <input type="checkbox"/>	FC2	1SNA007865R2600	100	
5 Fuses		FU520	1SNA008288R1500	10	
			1SNA008290R1300	10	
			1SNA008291R0000	10	
			1SNA008289R1600	10	
			1SNA008292R0100	10	
6 Assembly rods		TGA8	1SNA168672R1100	10	1.00
			1SNA168673R1200	10	
			1SNA168674R1300	10	
7 Spring retaining rings		ANT	1SNA168675R1400	10	
8 Tools		OUPAD	1SNA178944R0400	1	205.00
		OUMAD	1SNA179466R0600	1	29.00
9 Terminal block markers	White <input type="checkbox"/>	RC810	1SNA234000R0200	1	8.20

Complete list of accessories is indicated in the terminal block datasheet. Some accessories such as jumper bars may modify the terminal block's ratings: complete information in the accessories catalogue pages.

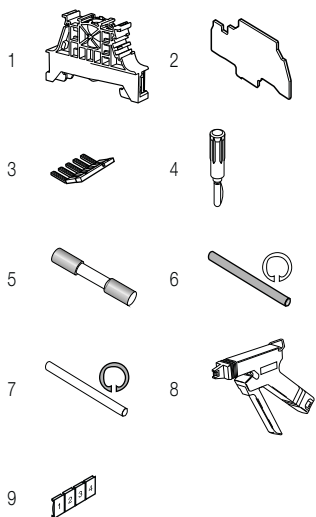

Disconnect IDC terminal blocks

Description	Color	Type	Part Number	Pkg pce	Weight (1 pce) g
Disconnect Profile aligned with D4/8.SF...ADO	Grey, blue <input type="checkbox"/>	D4/8.SNNT2.I.ADO	1SNA399779R2400	50	13.00

Technical data valid for copper conductors only.

D4/8.SF.I.ADO IDC Terminal Blocks

For 5 x 20 and 5 x 25 fuses - with test socket ADO - screw clamp 8 mm 0.315 in Spacing



1.5 mm²



1SN163110F0014

D4/8.SF.I.ADO

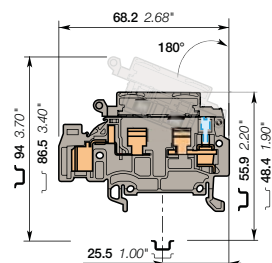

8 mm 0.315 in Spacing

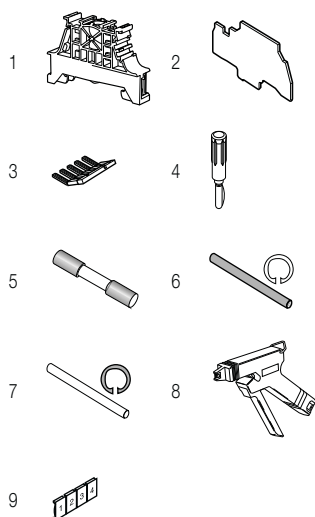

Description

- Protect your circuits with 5 x 20 and 5x 25 fuse terminal blocks (fuse not delivered with the terminal blocks),
- With the TE Connectivity ADO System®, experience the fastest and most reliable connection on the market,
- This solution brings all the benefits of the ADO System® and allows installators to connect on standard screw clamp,
- Up to 2 wires per connection in the ADO System® connection.

Ordering Details

Description	Color	Type	Part Number	Pkg pce	Weight (1 pce) g
Fuse With 2 test sockets DIA 2 mm 0.079 in	Grey <input type="checkbox"/>	D4/8.SFT2.I.ADO	1SNA399777R1200	50	13.00

Main Technical Data

		IEC	UL	CSA	Mounting Instructions
ADO	Rigid: Solid/Stranded Flexible without ferrule	0.34-1.5 mm ² 0.34-1.5 mm ²			Rail TH 35-7.5, TH 35-15
Screw clamp	Rigid: Solid/Stranded Flexible without ferrule Flexible with insulated ferrule Gauge	0.2-4 mm ² 0.22-4 mm ² A4			Wire stripping length 9.5 mm 0.37 in
Rated current / Rated cross section		6.3 A / 1.5 mm ²			Tool Flat screwdriver Ø 4 mm Ø 0.157 in
Rated short-time withstand current (1s)		180 A			Torque 0.5 - 0.8 N.m 4.4 - 7.1 lb.in
Rated voltage		630 V			
Impulse withstand voltage		8000 V			
Protection		IP20		NEMA 1	

The connecting capacity data for one Rigid: Solid/Stranded, or one Flexible conductor (when applicable) is a mandatory information required by IEC, UL and CSA standards (Copper conductors). All other data are provided as supplementary information only. For more details, please consult our CB, UL or CSA certificates and technical datasheet available on <http://www.TE.com>

RoHS	PCB	Gost R
<input type="checkbox"/>	<input type="checkbox"/>	<input type="checkbox"/>

Accessories

Description	Color	Type	Part Number	Pkg pce	Weight (1 pce) g
1 End Stops	Dark grey <input type="checkbox"/>	BAM4	1SNK900001R0000	50	14.00
		BAZ1	1SNK900002R0000	50	5.30
2 End Sections	Grey <input type="checkbox"/>	FEDAD10	1SNA399758R2700	20	3.00
3 Lateral Jumper Bars 10 poles		35 A	PC81-10	10	5.00
4 Test Plugs	Black <input type="checkbox"/>	FC2	1SNA007865R2600	100	
5 Fuses		FU520	1SNA008288R1500	10	
			1SNA008290R1300	10	
			1SNA008291R0000	10	
			1SNA008292R0100	10	
6 Assembly Rods		TGA8	1SNA168672R1100	10	1.00
			1SNA168673R1200	10	
			1SNA168674R1300	10	
7 Spring Retaining Rings		ANT	1SNA168675R1400	10	
8 Tools		OUPAD	1SNA178944R0400	1	205.00
		OUMAD	1SNA179466R0600	1	29.00
9 Terminal Block Markers Blank card	White <input type="checkbox"/>	RC810	1SNA234000R0200	1	8.20

Complete list of accessories is indicated in the terminal block datasheet.

Some accessories such as jumper bars may modify the terminal block's ratings: complete information in the accessories catalogue pages.

Disconnect IDC Terminal Blocks

Description	Color	Type	Part Number	Pkg pce	Weight (1 pce) g
Disconnect Profile aligned with D4/8.SF.I.ADO	Grey, Blue <input type="checkbox"/>	D4/8.SNNT2.I.ADO	1SNA399779R2400	50	13.00

Technical data valid for copper conductors only.

D4/8.SF.I.ADO IDC Terminal Blocks

For 5 x 20 and 5 x 25 fuses - with blown fuse indicator and test socket ADO - screw clamp - 8 mm 0.315 in spacing

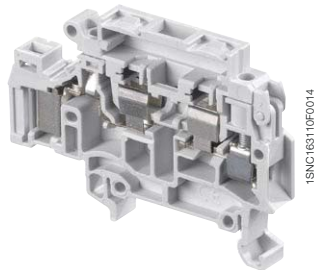

D4/8.SF.I.ADO

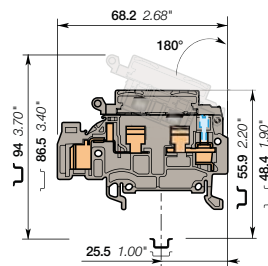

8 mm 0.315 in spacing

Description

- Protect your circuits with 5 x 20 and 5x 25 fuse terminal blocks (fuse not delivered with the terminal blocks),
- Quickly identify the defective circuit thanks to blown fuse indicators,
- With the TE Connectivity ADO System®, experience the fastest and most reliable connection on the market,
- This solution brings all the benefits of the ADO System® and allows installators to connect on standard screw clamp,
- Up to 2 wires per connection in the ADO System® connection.

Ordering Details

Description	Color	Type	Part Number	Pkg pce	Weight (1 pce) g
Fuse With blown fuse indicator by LED 24 V AC/DC and 2 test sockets DIA 2 mm 0.079 in	Grey	D4/8.SFDT2.I.ADO	1SNA399782R0000	50	13.00
With blown fuse indicator by neon 110 - 230 V AC and 2 test sockets DIA 2 mm 0.079 in	Grey	D4/8.SFLT2.I.ADO	1SNA399856R0200	50	13.00

Main Technical Data

		IEC	UL	CSA	Mounting Instructions	
ADO	Rigid: Solid/Stranded Flexible without ferrule	0.34-1.5 mm ² 0.34-1.5 mm ²			Rail	TH 35-7.5, TH 35-15
Screw clamp	Rigid: Solid/Stranded Flexible without ferrule Flexible with insulated ferrule Gauge	0.2-4 mm ² 0.22-4 mm ² A4			Wire stripping length	9.5 mm 0.37 in
Rated current / Rated cross section		6.3 A / 1.5 mm ²			Tool	Flat screwdriver Ø 4 mm Ø 0.157 in
Rated short-time withstand current (1s)		180 A			Torque	0.5 - 0.8 N.m 4.4 - 7.1 lb.in
Rated voltage		500 V				
Impulse withstand voltage		6000 V				
Protection		IP20	NEMA 1			

The connecting capacity data for one Rigid: Solid/Stranded, or one Flexible conductor (when applicable) is a mandatory information required by IEC, UL and CSA standards (Copper conductors). All other data are provided as supplementary information only. For more details, please consult our CB, UL or CSA certificates and technical datasheet available on <http://www.TE.com>



Leakage current: 24 V < 4.5 mA; 110 V < 0.5 mA; 230 V < 0.7 mA

Accessories

Description	Color	Type	Part Number	Pkg pce	Weight (1 pce) g
1 End Stops	Dark grey	BAM4	1SNK900001R0000	50	14.00
		BAZ1	1SNK900002R0000	50	5.30
2 End Sections	Grey	FEDAD10	1SNA399758R2700	20	3.00
3 Lateral Jumper Bars		PC81-10	1SNA173523R1100	10	5.00
4 Test Plugs	Black	FC2	1SNA007865R2600	100	
5 Fuses		FU520	1SNA008288R1500	10	
			1SNA008290R1300	10	
			1SNA008291R0000	10	
			1SNA008289R1600	10	
			1SNA008292R0100	10	
6 Assembly Rods		TGA8	1SNA168672R1100	10	1.00
			1SNA168673R1200	10	
			1SNA168674R1300	10	
7 Spring Retaining Rings		ANT	1SNA168675R1400	10	
8 Tools		OUPAD	1SNA178944R0400	1	205.00
		OUMAD	1SNA179466R0600	1	29.00
9 Terminal Block Markers	White	RC810	1SNA234000R0200	1	8.20

Complete list of accessories is indicated in the terminal block datasheet.

Some accessories such as jumper bars may modify the terminal block's ratings: complete information in the accessories catalogue pages.

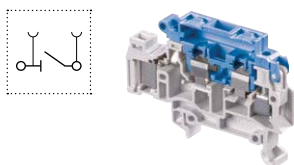
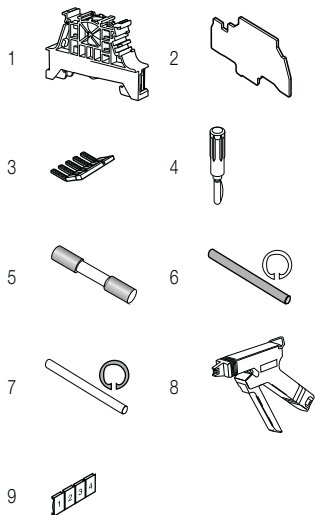

Disconnect IDC Terminal Blocks

Description	Color	Type	Part Number	Pkg pce	Weight (1 pce) g
Disconnect	Grey, Blue	D4/8.SNNT2.I.ADO	1SNA399779R2400	50	13.00

Technical data valid for copper conductors only.

D4/8.SF.I.ADO IDC terminal blocks

For 5 x 20 and 5 x 25 fuses - with test socket ADO - screw clamp 8 mm 0.315 in spacing



2.5 mm²
14 AWG

Description

- Protect your circuits with 5 x 20 and 5x 25 fuse terminal blocks (fuse not delivered with the terminal blocks),
- With the TE Connectivity ADO System®, experience the fastest and most reliable connection on the market,
- This solution brings all the benefits of the ADO System® and allows installators to connect on standard screw clamp,
- Up to 2 wires per connection in the ADO System® connection.

Ordering details

Description	Color	Type	Part Number	Pkg pce	Weight (1 pce) g
Fuse With 2 test sockets DIA 2 mm 0.079 in, With black marking for wire size 1-2.5 mm ² (16-14 AWG)	Grey <input type="checkbox"/>	D4/8.SFT2.I.ADO2	1SNA399762R1300	50	13.00



1SN163139F0014

D4/8.SF.I.ADO

Main technical data

		IEC	UL	CSA	Mounting instructions
ADO	Rigid: Solid/Stranded Flexible without ferrule	1-2.5 mm ² 1-2.5 mm ²			Rail TH 35-7.5, TH 35-15
Screw clamp	Rigid: Solid/Stranded Flexible without ferrule Flexible with insulated ferrule Gauge	0.2-4 mm ² 0.22-4 mm ² A4			Wire stripping length 9.5 mm 0.37 in
Rated current / Rated cross section		6.3 A / 2.5 mm ²			Tool Flat screwdriver Ø 4 mm Ø 0.157 in
Rated short-time withstand current (1s)		300 A			Torque 0.5 - 0.8 N.m 4.4 - 7.1 lb.in
Rated voltage		630 V			
Impulse withstand voltage		8000 V			
Protection		IP20	NEMA 1		

The connecting capacity data for one Rigid: Solid/Stranded, or one Flexible conductor (when applicable) is a mandatory information required by IEC, UL and CSA standards (Copper conductors). All other data are provided as supplementary information only. For more details, please consult our CB, UL or CSA certificates and technical datasheet available on <http://www.TE.com>

	RoHS <input type="checkbox"/>	RoHS	PCB <input type="checkbox"/>	Gost R <input type="checkbox"/>
--	-------------------------------	------	------------------------------	---------------------------------

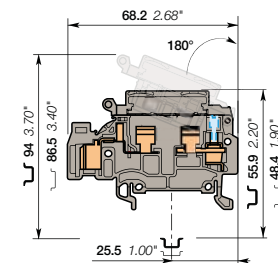

8 mm 0.315 in spacing

Accessories

Description	Color	Type	Part Number	Pkg pce	Weight (1 pce) g
1 End stops	Dark grey <input type="checkbox"/>	BAM4 BAZ1	1SNK900001R0000 1SNK900002R0000	50 50	14.00 5.30
2 End sections	Grey <input type="checkbox"/>	FEDAD10	1SNA399758R2700	20	3.00
3 Lateral jumper bars		PC81-10	1SNA173523R1100	10	5.00
4 Test plugs	Black <input type="checkbox"/>	FC2	1SNA007865R2600	100	
5 Fuses		FU520	1SNA008288R1500 1SNA008290R1300 1SNA008291R0000 1SNA008289R1600 1SNA008292R0100	10 10 10 10 10	
6 Assembly rods		TGA8	1SNA168672R1100 1SNA168673R1200 1SNA168674R1300	10 10 10	1.00
7 Spring retaining rings		ANT	1SNA168675R1400	10	
8 Tools		OUPAD OUMAD	1SNA178944R0400 1SNA179466R0600	1 1	205.00 29.00
9 Terminal block markers	White <input type="checkbox"/>	RC810	1SNA234000R0200	1	8.20

Complete list of accessories is indicated in the terminal block datasheet.

Some accessories such as jumper bars may modify the terminal block's ratings: complete information in the accessories catalogue pages.

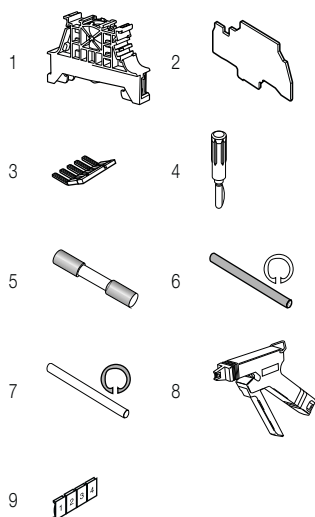

Disconnect IDC terminal blocks

Description	Color	Type	Part Number	Pkg pce	Weight (1 pce) g
Disconnect Profile aligned with D4/8.SF.I.ADO	Grey, blue <input type="checkbox"/>	D4/8.SNNT2.I.ADO2	1SNA399766R1700	50	13.00

Technical data valid for copper conductors only.

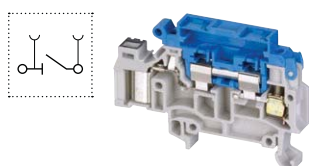

D4/8.SF.I.ADO IDC terminal blocks

For 5 x 20 and 5 x 25 fuses - with test socket ADO - screw clamp 8 mm 0.315 in spacing

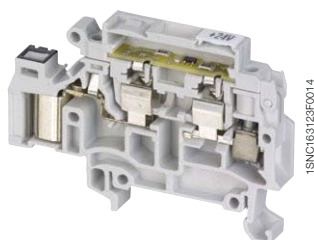

D4/8.SF.I.ADO

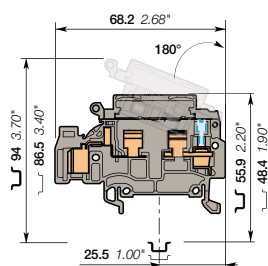

8 mm 0.315 in spacing

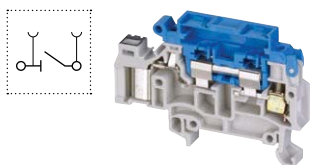
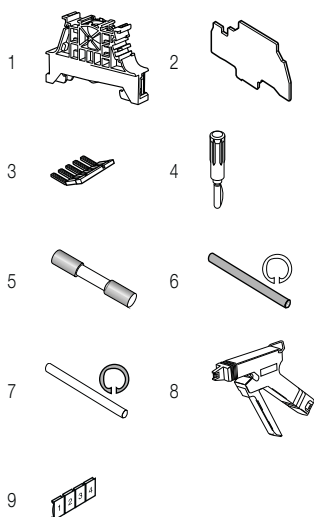

Description

- Protect your circuits with 5 x 20 and 5 x 25 fuse terminal blocks (fuse not delivered with the terminal blocks),
- Quickly identify the defective circuit thanks to blown fuse indicators,
- With the TE Connectivity ADO System®, experience the fastest and most reliable connection on the market,
- This solution brings all the benefits of the ADO System® and allows installators to connect on standard screw clamp,
- Up to 2 wires per connection in the ADO System® connection.

Ordering details

Description	Color	Type	Part Number	Pkg pce	Weight (1 pce) g
Fuse With blown fuse indicator by neon 110 - 230 V AC and 2 test sockets DIA 2 mm 0.079 in, with black marking for wire size 1-2.5 mm² (16-14 AWG)	Grey	<input type="checkbox"/> D4/8.SFLT2.I.ADO2	1SNA399768R2100	50	13.00
With blown fuse indicator by LED 24 V AC/DC and 2 test sockets DIA 2 mm 0.079 in, with black marking for wire size 1-2.5 mm² (16-14 AWG)	Grey	<input type="checkbox"/> D4/8.SFDT2.I.ADO2	1SNA399770R2700	50	13.00

Main technical data

		IEC	UL	CSA
ADO	Rigid: Solid/Stranded Flexible without ferrule	1-2.5 mm² 1-2.5 mm²		
Screw clamp	Rigid: Solid/Stranded Flexible without ferrule Flexible with insulated ferrule Gauge	0.2-4 mm² 0.22-4 mm²		
Rated current / Rated cross section		6.3 A / 2.5 mm²		
Rated short-time withstand current (I_{ts})		300 A		
Rated voltage		500 V		
Impulse withstand voltage		6000 V		
Protection		IP20	NEMA 1	

Mounting instructions

Rail		TH 35-7.5, TH 35-15
Wire stripping length		9.5 mm 0.37 in
Tool		Flat screwdriver Ø 4 mm Ø 0.157 in
Torque		0.5 - 0.8 N.m 4.4 - 7.1 lb.in

The connecting capacity data for one Rigid: Solid/Stranded, or one Flexible conductor (when applicable) is a mandatory information required by IEC, UL and CSA standards (Copper conductors). All other data are provided as supplementary information only. For more details, please consult our CB, UL or CSA certificates and technical datasheet available on <http://www.TE.com>

--	--

Leakage current: 24 V < 4.5 mA; 110 V < 0.5 mA; 230 V < 0.7 mA

Accessories

Description	Color	Type	Part Number	Pkg pce	Weight (1 pce) g
1 End stops	Dark grey	BAM4	1SNK900001R0000	50	14.00
		BAZ1	1SNK900002R0000	50	5.30
2 End sections	Grey	FEDAD10	1SNA399758R2700	20	3.00
3 Lateral jumper bars		PC81-10	1SNA173523R1100	10	5.00
4 Test plugs	Black	FC2	1SNA007865R2600	100	
5 Fuses		FU520	1SNA008288R1500	10	
			1SNA008290R1300	10	
			1SNA008291R0000	10	
			1SNA008289R1600	10	
			1SNA008292R0100	10	
6 Assembly rods		TGA8	1SNA168672R1100	10	1.00
			1SNA168673R1200	10	
			1SNA168674R1300	10	
7 Spring retaining rings		ANT	1SNA168675R1400	10	
8 Tools		OUPAD	1SNA178944R0400	1	205.00
		OUNAD	1SNA179466R0600	1	29.00
9 Terminal block markers	White	RC810	1SNA234000R0200	1	8.20

Complete list of accessories is indicated in the terminal block datasheet. Some accessories such as jumper bars may modify the terminal block's ratings: complete information in the accessories catalogue pages.

Disconnect IDC terminal blocks

Description	Color	Type	Part Number	Pkg pce	Weight (1 pce) g
Disconnect Profile aligned with D4/8.SF.I.ADO	Grey, blue	<input type="checkbox"/> D4/8.SNNT2.I.ADO2	1SNA399766R1700	50	13.00

Technical data valid for copper conductors only.

D4/8.SN.I.ADO IDC terminal blocks

Disconnect with lever - with test socket - ADO screw clamp 8 mm 0.315 in spacing

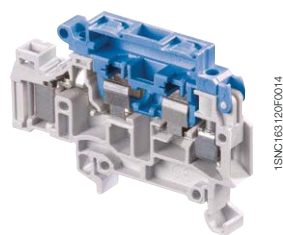

D4/8.SN.I.ADO

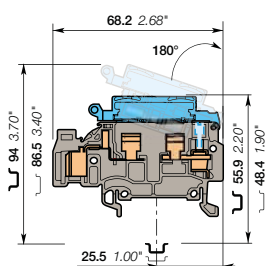

8 mm 0.315 in spacing

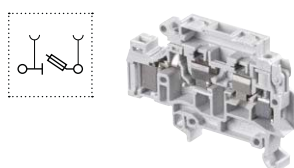
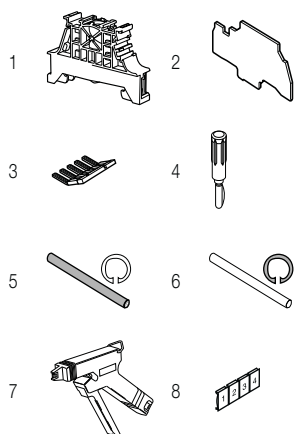

Description

- Disconnect terminal blocks aligned with fuse holder terminal blocks,
- With the TE Connectivity ADO System®, experience the fastest and most reliable connection on the market,
- This solution brings all the benefits of the ADO System® and allows installators to connect on standard screw clamp,
- Up to 2 wires per connection in the ADO System® connection.

Ordering details

Description	Color	Type	Part Number	Pkg pce	Weight (1 pce) g
Disconnect With 2 test sockets DIA 2 mm 0.079 in	Grey, blue	D4/8.SNNT2.I.ADO	1SNA399779R2400	50	13.00

Main technical data

	IEC	UL	CSA	Mounting instructions
				Rail TH 35-7.5, TH 35-15
				Wire stripping length 9.5 mm 0.37 in
Screw clamp	Rigid: Solid/Stranded Flexible without ferrule Flexible with insulated ferrule Gauge	0.2-4 mm² 0.22-4 mm² A4		Tool Flat screwdriver Ø 4 mm Ø 0.157 in
Rated current / Rated cross section	10 A / 1.5 mm²			Torque 0.5 - 0.8 Nm 4.4 - 7.1 lb.in
Rated short-time withstand current (1s)	180 A			
Rated voltage	630 V			
Impulse withstand voltage	8000 V			
Protection	IP20	NEMA 1		

The connecting capacity data for one Rigid: Solid/Stranded, or one Flexible conductor (when applicable) is a mandatory information required by IEC, UL and CSA standards (Copper conductors). All other data are provided as supplementary information only. For more details, please consult our CB, UL or CSA certificates and technical datasheet available on <http://www.TE.com>

--	--	--	--	--	--

Accessories

Description	Color	Type	Part Number	Pkg pce	Weight (1 pce) g
1 End stops	Dark grey	BAM4	1SNK900001R0000	50	14.00
		BAZ1	1SNK900002R0000	50	5.30
2 End sections	Grey	FEDAD10	1SNA399758R2700	20	3.00
3 Lateral jumper bars		PC81-10	1SNA173523R1100	10	5.00
4 Test plugs	Black	FC2	1SNA007865R2600	100	
5 Assembly rods		TGA8	1SNA168672R1100	10	1.00
			1SNA168673R1200	10	
			1SNA168674R1300	10	
6 Spring retaining rings		ANT	1SNA168675R1400	10	
7 Tools		OUPAD	1SNA178944R0400	1	205.00
		OUMAD	1SNA179466R0600	1	29.00
8 Terminal block markers	White	RC810	1SNA234000R0200	1	8.20

Complete list of accessories is indicated in the terminal block datasheet.

Some accessories such as jumper bars may modify the terminal block's ratings: complete information in the accessories catalogue pages.

Fuse IDC terminal blocks

Description	Color	Type	Part Number	Pkg pce	Weight (1 pce) g
Fuse Profile aligned with D4/8.SN.I.ADO	Grey	D4/8.SFT2.I.ADO	1SNA399777R1200	50	13.00

Technical data valid for copper conductors only.

2

1SNC163100S0201 - Rev. A

D4/8.SN.I.ADO IDC terminal blocks

Disconnect with lever - with test socket - ADO screw clamp 8 mm 0.315 in spacing

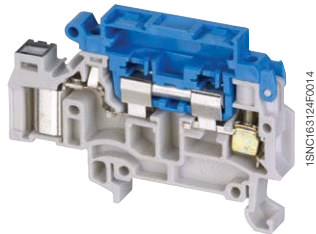

D4/8.SN.I.ADO

Description

- Disconnect terminal blocks aligned with fuse holder terminal blocks,
- With the TE Connectivity ADO System®, experience the fastest and most reliable connection on the market,
- This solution brings all the benefits of the ADO System® and allows installators to connect on standard screw clamp,
- Up to 2 wires per connection in the ADO System® connection.

Ordering details

Description	Color	Type	Part Number	Pkg pce	Weight (1 pce) g
Disconnect With 2 test sockets DIA 2 mm 0.079 in, with black marking for wire size 1-2.5 mm² (16-14 AWG)	Grey, blue	D4/8.SNNT2.I.ADO2	1SNA399766R1700	50	13.00

Main technical data

		IEC	UL	CSA	Mounting instructions	
ADO	Rigid: Solid/Stranded Flexible without ferrule	1-2.5 mm² 1-2.5 mm²			Rail	TH 35-7.5, TH 35-15
Screw clamp	Rigid: Solid/Stranded Flexible without ferrule Flexible with insulated ferrule Gauge	0.2-4 mm² 0.22-4 mm² A4			Wire stripping length	9.5 mm 0.37 in
Rated current / Rated cross section		6.3 A / 2.5 mm²			Tool	Flat screwdriver Ø 4 mm Ø 0.157 in
Rated short-time withstand current (1s)		300 A			Torque	0.5 - 0.8 N.m 4.4 - 7.1 lb.in
Rated voltage		630 V				
Impulse withstand voltage		8000 V				
Protection		IP20	NEMA 1			

The connecting capacity data for one Rigid: Solid/Stranded, or one Flexible conductor (when applicable) is a mandatory information required by IEC, UL and CSA standards (Copper conductors). All other data are provided as supplementary information only. For more details, please consult our CB, UL or CSA certificates and technical datasheet available on <http://www.TE.com>

RoHS	Gost R
------	--------

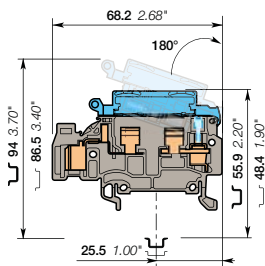

8 mm 0.315 in spacing

Accessories

Description	Color	Type	Part Number	Pkg pce	Weight (1 pce) g
1 End stops	Dark grey	BAM4	1SNK900001R0000	50	14.00
		BAZ1	1SNK900002R0000	50	5.30
2 End sections	Grey	FEDAD10	1SNA399758R2700	20	3.00
3 Lateral jumper bars		PC81-10	1SNA173523R1100	10	5.00
4 Test plugs	Black	FC2	1SNA007865R2600	100	
5 Assembly rods		TGA8	1SNA168672R1100	10	1.00
			1SNA168673R1200	10	
			1SNA168674R1300	10	
6 Spring retaining rings		ANT	1SNA168675R1400	10	
7 Tools		OUPAD	1SNA178944R0400	1	205.00
		OUMAD	1SNA179466R0600	1	29.00
8 Terminal block markers	White	RC810	1SNA234000R0200	1	8.20

Complete list of accessories is indicated in the terminal block datasheet.

Some accessories such as jumper bars may modify the terminal block's ratings: complete information in the accessories catalogue pages.

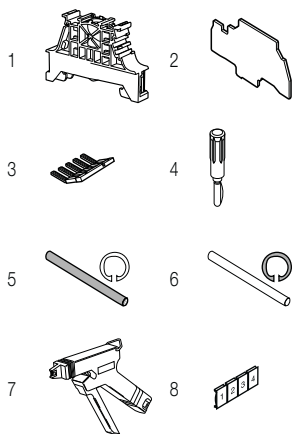

Fuse IDC terminal blocks

Description	Color	Type	Part Number	Pkg pce	Weight (1 pce) g
Fuse Profile aligned with D4/8.SN.I.ADO	Grey	D4/8.SFT2.I.ADO2	1SNA399762R1300	50	13.00

Technical data valid for copper conductors only.

D1/5.ADO IDC terminal blocks

Feed-through ADO - ADO - 5 mm 0.197 in spacing

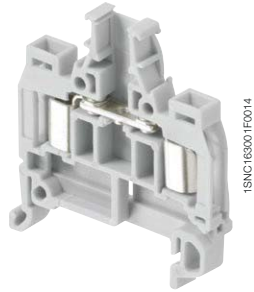

D1/5.ADO

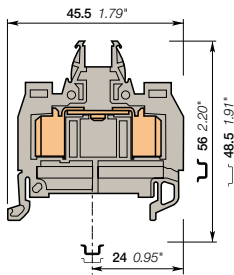

5 mm 0.197 in spacing

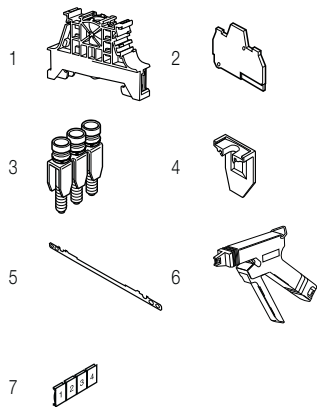

Description

- With the TE Connectivity ADO System®, experience the fastest and most reliable connection on the market,
- Designed for control applications exposed to severe constraints (vibrations, shocks, corrosion etc.),
- Up to 2 wires per connection.

Ordering details

Description	Color	Type	Part Number	Pkg pce	Weight (1 pce) g
Feed-through	Grey	D1/5.ADO	1SNA199563R2400	50	5.00
	Blue	D1/5.N.ADO	1SNA199565R2600	50	5.00
	Orange	D1/5.ADO	1SNA199564R2500	50	5.00

Main technical data

		IEC	UL	CSA	Rail	TH 35-7.5, TH 35-15
ADO	Rigid: Solid/Stranded Flexible without ferrule	0.2-1 mm² 0.22-1 mm²		22-18 AWG	Wire stripping length	
Screw clamp	Rigid: Solid/Stranded Flexible without ferrule Flexible with insulated ferrule Gauge				Tool	
Rated current / Rated cross section		13.5 A / 1 mm²		7 A / 18 AWG		
Rated short-time withstand current (1s)		120 A				
Rated voltage		1000 V		600 V		
Impulse withstand voltage		8000 V			Torque	
Protection		IP20		NEMA 1		

The connecting capacity data for one Rigid: Solid/Stranded, or one Flexible conductor (when applicable) is a mandatory information required by IEC, UL and CSA standards (Copper conductors). All other data are provided as supplementary information only. For more details, please consult our CB, UL or CSA certificates and technical datasheet available on <http://www.TE.com>

RoHS	RoHS	cCSAus	PC	Gost R
------	------	--------	----	--------

Accessories

Description	Color	Type	Part Number	Pkg pce	Weight (1 pce) g
1 End stops	Dark grey	BAM4	1SNK900001R0000	50	14.00
		BAZ1	1SNK900002R0000	50	5.30
2 End sections	Grey	FEMAD3	1SNA199341R0500	20	2.50
3 Jumper bars		BJMI5-2	1SNA176278R1600	10	3.30
		BJMI5-3	1SNA176279R1700	10	5.00
		BJMI5-4	1SNA176280R0500	10	6.70
		BJMI5-5	1SNA176281R2200	10	8.40
		BJMI5-10	1SNA176282R2300	10	16.90
4 Circuit separators	Grey	SCAD5	1SNA199551R2000	10	0.30
5 Shield connectors		CBM5	1SNA178745R1400	50	
6 Tools		OUPAD	1SNA178944R0400	1	205.00
		OUMAD	1SNA179466R0600	1	29.00
7 Terminal block markers	White	RC510	1SNA231000R0700	1	5.20

Complete list of accessories is indicated in the terminal block datasheet.

Some accessories such as jumper bars may modify the terminal block's ratings: complete information in the accessories catalogue pages.

Ground IDC terminal blocks

Description	Color	Type	Part Number	Pkg pce	Weight (1 pce) g
Ground	Green-yellow	D1/5.P.ADO	1SNA399031R2200	50	9.00

Technical data valid for copper conductors only.

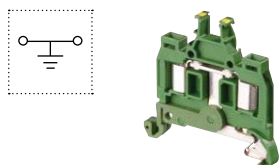

D1.5/6.ADO IDC terminal blocks

Feed-through ADO - ADO - 6 mm 0.236 in spacing



D1.5/6.ADO

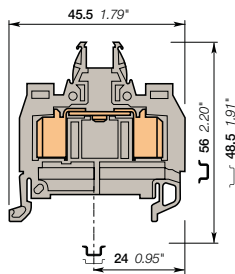

6 mm 0.236 in spacing

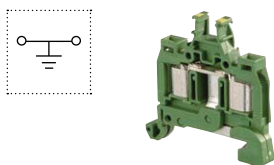
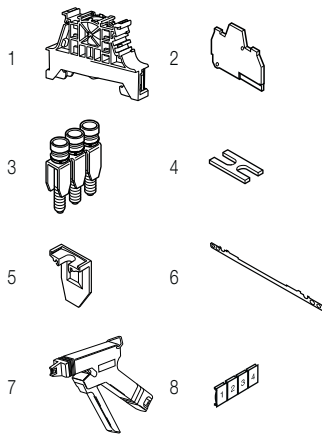

Description

- With the TE Connectivity ADO System®, experience the fastest and most reliable connection on the market,
- Designed for control applications exposed to severe constraints (vibrations, shocks, corrosion etc.),
- Up to 2 wires per connection.

Ordering details

Description	Color	Type	Part Number	Pkg pce	Weight (1 pce) g
Feed-through	Grey	D1.5/6.ADO	1SNA199051R2600	50	6.00
	Blue	D1.5/6.N.ADO	1SNA199053R2000	50	6.00
	Orange	D1.5/6.ADO	1SNA199052R2700	50	6.00

Main technical data

		IEC	UL	CSA	Mounting instructions	
ADO	Rigid: Solid/Stranded	0.34-1.5 mm²	22-14 AWG	22-16 AWG	Rail	TH 35-7.5, TH 35-15
	Flexible without ferrule	0.34-1.5 mm²			Wire stripping length	
Screw clamp	Rigid: Solid/Stranded				Tool	
	Flexible without ferrule					
	Flexible with insulated ferrule					
	Gauge					
Rated current / Rated cross section		17.5 A / 1.5 mm²	10 A / 14 AWG	18 A / 16 AWG	Torque	
Rated short-time withstand current (1s)		180 A				
Rated voltage		1000 V	600 V	600 V		
Impulse withstand voltage		8000 V				
Protection		IP20	NEMA 1			

The connecting capacity data for one Rigid: Solid/Stranded, or one Flexible conductor (when applicable) is a mandatory information required by IEC, UL and CSA standards (Copper conductors). All other data are provided as supplementary information only. For more details, please consult our CB, UL or CSA certificates and technical datasheet available on <http://www.TE.com>

RoHS	RoHS	USR	cCSAus	Gost R
------	------	-----	--------	--------

Accessories

Description	Color	Type	Part Number	Pkg pce	Weight (1 pce) g	
1 End stops	Dark grey	BAM4	1SNK900001R0000	50	14.00	
		BAZ1	1SNK900002R0000	50	5.30	
2 End sections	Grey	FEMAD3	1SNA199341R0500	20	2.50	
3 Jumper bars		2 poles	BJMI6-2	1SNA176663R0000	10	4.40
		3 poles	BJMI6-3	1SNA176664R0100	10	6.70
		4 poles	BJMI6-4	1SNA176665R0200	10	8.90
		5 poles	BJMI6-5	1SNA176666R0300	10	11.20
		10 poles	BJMI6-10	1SNA176667R0400	10	22.40
4 Cross spacing jumpers		5 mm 0.200 in - 6 mm 0.236 in - 8 mm 0.315 in	EL6	1SNA173627R2100	10	0.10
		Universal screw jumper bar kit N°I	BJDP1	1SNA179623R0300	10	7.00
		Universal screw jumper bar kit N°III	BJDP3	1SNA179625R0500	10	5.00
5 Circuit separators	Grey	SCAD	1SNA196896R0000	10		
6 Shield connectors		CBM5	1SNA178745R1400	50		
7 Tools		Semi automatic tool	OUPAD	1SNA178944R0400	1	205.00
		Hand tool	OUMAD	1SNA179466R0600	1	29.00
8 Terminal block markers	White	RC610	1SNA233000R0100	1	7.50	

Complete list of accessories is indicated in the terminal block datasheet.

Some accessories such as jumper bars may modify the terminal block's ratings: complete information in the accessories catalogue pages.

Ground IDC terminal blocks

Description	Color	Type	Part Number	Pkg pce	Weight (1 pce) g
Ground	Green-yellow	D1.5/6.P.ADO	1SNA199098R2600	50	6.00

Technical data valid for copper conductors only.

D2.5/8.ADO IDC terminal blocks

Feed-through ADO - ADO - 8 mm 0.315 in spacing



D2.5/8.ADO

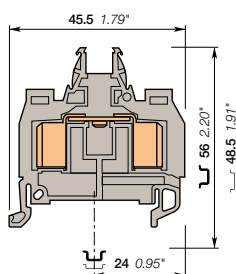

8 mm 0.315 in spacing

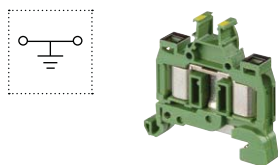
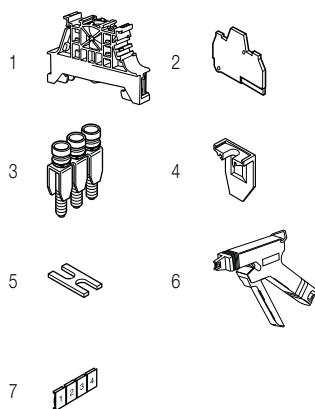

Description

- With the TE Connectivity ADO System®, experience the fastest and most reliable connection on the market,
- Designed for control applications exposed to severe constraints (vibrations, shocks, corrosion etc.),
- Up to 2 wires per connection.

Ordering details

Description	Color	Type	Part Number	Pkg pce	Weight (1 pce) g
Feed-through With black marking for wire size 1-2.5 mm² (16-14 AWG)	Grey	D2.5/8.ADO	1SNA199059R0600	50	9.00
	Blue	D2.5/8.N.ADO	1SNA199061R2000	50	9.00
	Orange	D2.5/8.ADO	1SNA199060R0300	50	9.00

Main technical data

		IEC	UL	CSA	Mounting instructions	
ADO	Rigid: Solid/Stranded	1-2.5 mm²	16-14 AWG	16-14 AWG	Rail	TH 35-7.5, TH 35-15
	Flexible without ferrule	1-2.5 mm²			Wire stripping length	
Screw clamp	Rigid: Solid/Stranded				Tool	
	Flexible without ferrule					
	Flexible with insulated ferrule					
	Gauge					
Rated current / Rated cross section		24 A / 2.5 mm²	15 A / 14 AWG	25 A / 14 AWG	Torque	
Rated short-time withstand current (1s)		300 A				
Rated voltage		1000 V	600 V	600 V		
Impulse withstand voltage		8000 V				
Protection		IP20	NEMA 1			

The connecting capacity data for one Rigid: Solid/Stranded, or one Flexible conductor (when applicable) is a mandatory information required by IEC, UL and CSA standards (Copper conductors). All other data are provided as supplementary information only. For more details, please consult our CB, UL or CSA certificates and technical datasheet available on <http://www.TE.com>

RoHS	UR	cCSAus	Gost R						
------	----	--------	--------	--	--	--	--	--	--

Accessories

Description	Color	Type	Part Number	Pkg pce	Weight (1 pce) g	
1 End stops	Dark grey	BAM4	1SNK900001R0000	50	14.00	
		BAZ1	1SNK900002R0000	50	5.30	
2 End sections	Grey	FEMAD3	1SNA199341R0500	20	2.50	
3 Jumper bars		2 poles	BJM8-2	1SNA176669R1600	10	4.50
		3 poles	BJM8-3	1SNA176670R1300	10	6.00
		4 poles	BJM8-4	1SNA176671R0000	10	10.00
		5 poles	BJM8-5	1SNA176672R0100	10	12.22
		10 poles	BJM8-10	1SNA176673R0200	10	20.00
4 Circuit separators	Grey	SCAD	1SNA196896R0000	10		
5 Cross spacing jumpers		EL6	1SNA173627R2100	10	0.10	
		BJDP1	1SNA179623R0300	10	7.00	
		BJDP3	1SNA179625R0500	10	5.00	
6 Tools		Semi automatic tool	OUPAD	1	205.00	
		Hand tool	OUMAD	1	29.00	
7 Terminal block markers	White	RC810	1SNA234000R0200	1	8.20	

Complete list of accessories is indicated in the terminal block datasheet.

Some accessories such as jumper bars may modify the terminal block's ratings: complete information in the accessories catalogue pages.

Ground IDC terminal blocks

Description	Color	Type	Part Number	Pkg pce	Weight (1 pce) g
Ground	Green-Yellow	D2.5/8.P.ADO	1SNA199091R1700	50	9.00

Technical data valid for copper conductors only.

D4/8.ADO IDC terminal blocks

Feed-through ADO-ADO - 8 mm 0.315 in spacing



D4/8.ADO

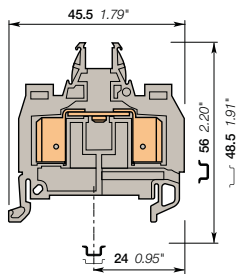

8 mm 0.315 in spacing

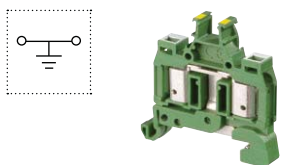
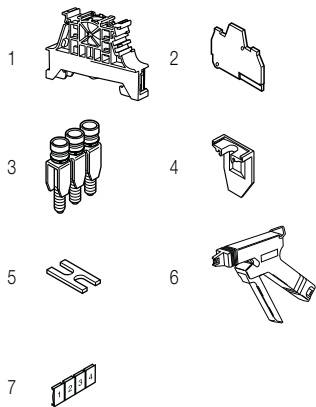

Description

- With the TE Connectivity ADO System®, experience the fastest and most reliable connection on the market,
- Designed for control applications exposed to severe constraints (vibrations, shocks, corrosion etc.).

Ordering details

Description	Color	Type	Part Number	Pkg pce	Weight (1 pce) g
Feed-through With white marking for wire size 4 mm² (12 AWG)	Grey	D4/8.ADO	1SNA399244R1400	50	9.00
	Blue	D4/8.N.ADO	1SNA399318R1600	50	9.00
	Orange	D4/8.ADO	1SNA399801R0400	50	9.00

Main technical data

		IEC	UL	CSA	Mounting instructions
ADO	Rigid: Solid/Stranded Flexible without ferrule	4 mm² 4 mm²		14-12 AWG	Rail TH 35-7.5, TH 35-15 Wire stripping length
Screw clamp	Rigid: Solid/Stranded Flexible without ferrule Flexible with insulated ferrule Gauge				Tool
Rated current / Rated cross section		32 A / 4 mm²		25 A / 12 AWG	
Rated short-time withstand current (1s)		480 A			
Rated voltage		1000 V		600 V	
Impulse withstand voltage		8000 V			Torque
Protection		IP20	NEMA 1		

The connecting capacity data for one Rigid: Solid/Stranded, or one Flexible conductor (when applicable) is a mandatory information required by IEC, UL and CSA standards (Copper conductors). All other data are provided as supplementary information only. For more details, please consult our CB, UL or CSA certificates and technical datasheet available on <http://www.TE.com>

RoHS	RoHS	cCSAus	Gost R						
------	------	--------	--------	--	--	--	--	--	--

Accessories

Description	Color	Type	Part Number	Pkg pce	Weight (1 pce) g	
1 End stops	Dark grey	BAM4	1SNK900001R0000	50	14.00	
		BAZ1	1SNK900002R0000	50	5.30	
2 End sections	Grey	FEMAD3	1SNA199341R0500	20	2.50	
3 Jumper bars		2 poles	BJMI8-2	1SNA176669R1600	10	4.50
		3 poles	BJMI8-3	1SNA176670R1300	10	6.00
		4 poles	BJMI8-4	1SNA176671R0000	10	10.00
		5 poles	BJMI8-5	1SNA176672R0100	10	12.22
		10 poles	BJMI8-10	1SNA176673R0200	10	20.00
4 Circuit separators	Grey	SCAD	1SNA196896R0000	10		
5 Cross spacing jumpers		5 mm 0.200 in - 6 mm 0.236 in - 8 mm 0.315 in	EL6	1SNA173627R2100	10	0.10
		Universal screw jumper bar kit N ^{PI}	BJDP1	1SNA179623R0300	10	7.00
		Universal screw jumper bar kit N ^{III}	BJDP3	1SNA179625R0500	10	5.00
6 Tools		Semi automatic tool	OUPAD	1SNA178944R0400	1	205.00
		Hand tool	OUMAD	1SNA179466R0600	1	29.00
7 Terminal block markers	White	RC810	1SNA234000R0200	1	8.20	

Complete list of accessories is indicated in the terminal block datasheet.

Some accessories such as jumper bars may modify the terminal block's ratings: complete information in the accessories catalogue pages.

Ground IDC terminal blocks

Description	Color	Type	Part Number	Pkg pce	Weight (1 pce) g
Ground Profile aligned with D4/8.ADO	Green-Yellow	D4/8.P.ADO	1SNA399250R2600	50	9.00

Technical data valid for copper conductors only.

D1/5.P.ADO IDC terminal blocks

Ground ADO - ADO - 5 mm 0.197 in spacing

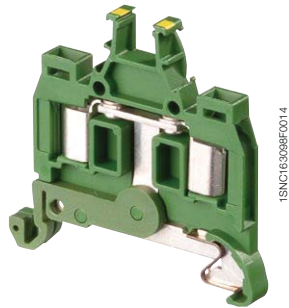

D1/5.P.ADO

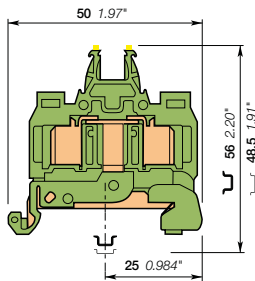

5 mm 0.197 in spacing

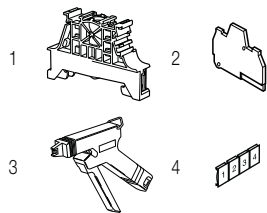

Description

- Protect your installation in the event of a short-circuit thanks to our screwless rail contact non operator dependent,
- Secure mounting or removal from the rail,
- With the TE Connectivity ADO System®, experience the fastest and most reliable connection on the market,
- Up to 2 wires per connection.

Ordering details

Description	Color	Type	Part Number	Pkg pce	Weight (1 pce) g
Ground Screwless rail connection	Green-yellow	D1/5.P.ADO	1SNA399031R2200	50	9.00

Main technical data

		IEC	UL	CSA	Mounting instructions	
ADO	Rigid: Solid/Stranded Flexible without ferrule	0.2-1 mm² 0.22-1 mm²		22-18 AWG	Rail	TH 35-7.5, TH 35-15
Screw clamp	Rigid: Solid/Stranded Flexible without ferrule Flexible with insulated ferrule Gauge				Wire stripping length	
Rated cross section		1 mm²		18 AWG	Tool	
Rated short-time withstand current (1s)		120 A			Torque	
Protection		IP20	NEMA 1			

The connecting capacity data for one Rigid: Solid/Stranded, or one Flexible conductor (when applicable) is a mandatory information required by IEC, UL and CSA standards (Copper conductors). All other data are provided as supplementary information only. For more details, please consult our CB, UL or CSA certificates and technical datasheet available on <http://www.TE.com>

RoHS	RoHS	cCSAus	Gost R						
------	------	--------	--------	--	--	--	--	--	--

Accessories

Description	Color	Type	Part Number	Pkg pce	Weight (1 pce) g
1 End stops	Dark grey	BAM4	1SNK900001R0000	50	14.00
		BAZ1	1SNK900002R0000	50	5.30
2 End sections	Grey	FEMAD3	1SNA199341R0500	20	2.50
3 Tools		OUPAD	1SNA178944R0400	1	205.00
		OUMAD	1SNA179466R0600	1	29.00
4 Terminal block markers	White	RC510	1SNA231000R0700	1	5.20

Complete list of accessories is indicated in the terminal block datasheet.

Some accessories such as jumper bars may modify the terminal block's ratings: complete information in the accessories catalogue pages.

Technical data valid for copper conductors only.

D1.5/6.P.ADO IDC terminal blocks

Ground ADO - ADO - 6 mm 0.236 in spacing

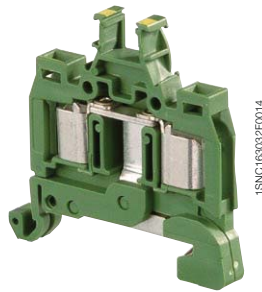

D1.5/6.P.ADO

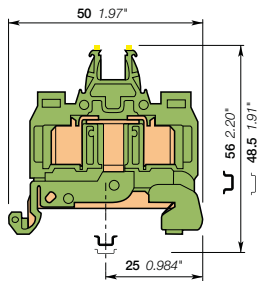

6 mm 0.236 in spacing

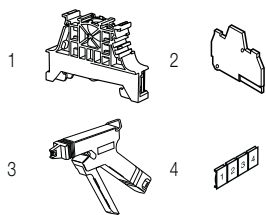

Description

- Protect your installation in the event of a short-circuit thanks to our screwless rail contact non operator dependent,
- Secure mounting or removal from the rail,
- With the TE Connectivity ADO System®, experience the fastest and most reliable connection on the market,
- Up to 2 wires per connection.

Ordering details

Description	Color	Type	Part Number	Pkg pce	Weight (1 pce) g
Ground Screwless rail connection	Green-yellow	D1.5/6.P.ADO	1SNA199098R2600	50	6.00

Main technical data

		IEC	UL	CSA	Mounting instructions	
ADO	Rigid: Solid/Stranded	0.34-1.5 mm²	22-16 AWG	22-16 AWG	Rail	TH 35-7.5, TH 35-15
	Flexible without ferrule	0.34-1.5 mm²			Wire stripping length	
Screw clamp	Rigid: Solid/Stranded				Tool	
	Flexible without ferrule					
	Flexible with insulated ferrule					
	Gauge					
Rated cross section		1.5 mm²	16 AWG	16 AWG	Torque	
Rated short-time withstand current (1s)		180 A				
Protection		IP20	NEMA 1			

The connecting capacity data for one Rigid: Solid/Stranded, or one Flexible conductor (when applicable) is a mandatory information required by IEC, UL and CSA standards (Copper conductors). All other data are provided as supplementary information only. For more details, please consult our CB, UL or CSA certificates and technical datasheet available on <http://www.TE.com>

RoHS	UL	cCSAus	Gost R
------	----	--------	--------

Accessories

Description	Color	Type	Part Number	Pkg pce	Weight (1 pce) g	
1 End stops	Dark grey	BAM4	1SNK900001R0000	50	14.00	
		BAZ1	1SNK900002R0000	50	5.30	
2 End sections	Grey	FEMAD3	1SNA199341R0500	20	2.50	
3 Tools		Semi automatic tool	OUPAD	1SNA178944R0400	1	205.00
		Hand tool	OUMAD	1SNA179466R0600	1	29.00
4 Terminal block markers	White	RC610	1SNA233000R0100	1	7.50	

Complete list of accessories is indicated in the terminal block datasheet.

Some accessories such as jumper bars may modify the terminal block's ratings: complete information in the accessories catalogue pages.

Technical data valid for copper conductors only.

D2.5/8.P.ADO IDC terminal blocks

Ground ADO - ADO - 8 mm 0.315 in spacing

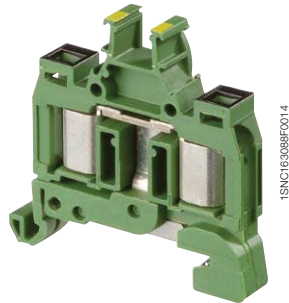

D2.5/8.P.ADO

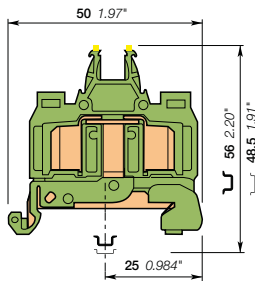

Description

- Protect your installation in the event of a short-circuit thanks to our screwless rail contact non operator dependent,
- Secure mounting or removal from the rail,
- With the TE Connectivity ADO System®, experience the fastest and most reliable connection on the market,
- Up to 2 wires per connection.

Ordering details

Description	Color	Type	Part Number	Pkg pce	Weight (1 pce) g
Ground Screwless rail connection with black marking for wire size 1-2.5 mm² (16-14 AWG)	Green-yellow	D2.5/8.P.ADO	1SNA199091R1700	50	9.00

Main technical data

		IEC	UL	CSA	Mounting instructions
ADO	Rigid: Solid/Stranded Flexible without ferrule	1-2.5 mm² 1-2.5 mm²	16-14 AWG		Rail TH 35-7.5, TH 35-15 Wire stripping length
Screw clamp	Rigid: Solid/Stranded Flexible without ferrule Flexible with insulated ferrule Gauge				Tool
Rated cross section		2.5 mm²	14 AWG		
Rated short-time withstand current (1s)		300 A			Torque
Protection		IP20	NEMA 1		

The connecting capacity data for one Rigid: Solid/Stranded, or one Flexible conductor (when applicable) is a mandatory information required by IEC, UL and CSA standards (Copper conductors). All other data are provided as supplementary information only. For more details, please consult our CB, UL or CSA certificates and technical datasheet available on <http://www.TE.com>



8 mm 0.315 in spacing

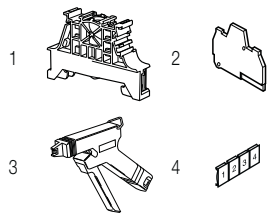

Accessories

Description	Color	Type	Part Number	Pkg pce	Weight (1 pce) g
1 End stops	Dark grey	BAM4	1SNK900001R0000	50	14.00
		BAZ1	1SNK900002R0000	50	5.30
2 End sections	Grey	FEMAD3	1SNA199341R0500	20	2.50
3 Tools		OUPAD	1SNA178944R0400	1	205.00
		OUMAD	1SNA179466R0600	1	29.00
4 Terminal block markers	White	RC810	1SNA234000R0200	1	8.20

Complete list of accessories is indicated in the terminal block datasheet.

Some accessories such as jumper bars may modify the terminal block's ratings: complete information in the accessories catalogue pages.

Technical data valid for copper conductors only.

D4/8.P.ADO IDC terminal blocks

Ground ADO - ADO - 8 mm 0.315 in spacing

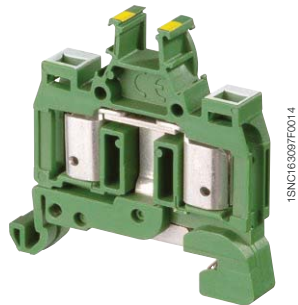

D4/8.P.ADO

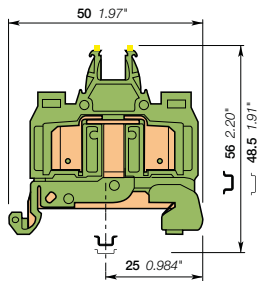

8 mm 0.315 in spacing

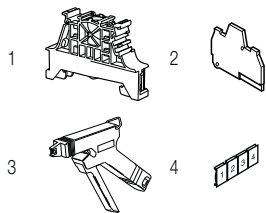

Description

- Protect your installation in the event of a short-circuit thanks to our screwless rail contact non operator dependent,
- Secure mounting or removal from the rail,
- With the TE Connectivity ADO System®, experience the fastest and most reliable connection on the market,

Ordering details

Description	Color	Type	Part Number	Pkg	Weight
Ground Screwless rail connection, with white marking for wire size 4 mm² (12 AWG)	Green-yellow	D4/8.P.ADO	1SNA399250R2600	50 pce	9.00 (1 pce) g

Main technical data

		IEC	UL	CSA	Mounting instructions
ADO	Rigid: Solid/Stranded Flexible without ferrule	4 mm² 4 mm²		14-12 AWG	Rail TH 35-7.5, TH 35-15
Screw clamp	Rigid: Solid/Stranded Flexible without ferrule Flexible with insulated ferrule Gauge				Wire stripping length Tool
Rated cross section		4 mm²		12 AWG	Torque
Rated short-time withstand current (1s)		480 A			
Protection		IP20	NEMA 1		

The connecting capacity data for one Rigid: Solid/Stranded, or one Flexible conductor (when applicable) is a mandatory information required by IEC, UL and CSA standards (Copper conductors). All other data are provided as supplementary information only. For more details, please consult our CB, UL or CSA certificates and technical datasheet available on <http://www.TE.com>

RoHS	RoHS	cCSAus	Gost R
------	------	--------	--------

Accessories

Description	Color	Type	Part Number	Pkg	Weight
1 End stops	Dark grey	BAM4	1SNK900001R0000	50 pce	14.00 (1 pce) g
		BAZ1	1SNK900002R0000	50 pce	5.30 (1 pce) g
2 End sections	Grey	FEMAD3	1SNA199341R0500	20 pce	2.50 (1 pce) g
3 Tools		OUPAD	1SNA178944R0400	1 pce	205.00 (1 pce) g
		OUMAD	1SNA179466R0600	1 pce	29.00 (1 pce) g
4 Terminal block markers	White	RC810	1SNA234000R0200	1 pce	8.20 (1 pce) g

Complete list of accessories is indicated in the terminal block datasheet.

Some accessories such as jumper bars may modify the terminal block's ratings: complete information in the accessories catalogue pages.

Technical data valid for copper conductors only.

D1.5/6.D2.ADO IDC terminal blocks

Double deck with 2 feed-through circuits ADO-ADO 6 mm 0.236 in spacing



D1.5/6.D2.ADO

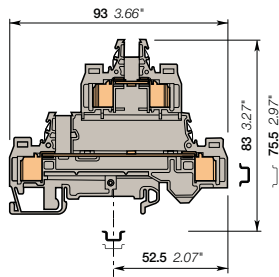

6 mm 0.236 in spacing

Description

- Save space with 2 decks terminal block,
- With the TE Connectivity ADO System®, experience the fastest and most reliable connection on the market,
- Designed for control applications exposed to severe constrains (vibrations, shocks, corrosion etc.),
- Up to 2 wires per connection.

Ordering details

Description	Color	Type	Part Number	Pkg pce	Weight (1 pce) g
Feed-through With 2 feed-through circuits	Grey <input type="checkbox"/>	D1.5/6.D2.ADO	1SNA199480R2600	50	18.00

Main technical data

	IEC	UL	CSA	Mounting instructions
ADO	Rigid: Solid/Stranded Flexible without ferrule Flexible with insulated ferrule	0.28-1.5 mm² 0.34-1.5 mm²		Rail TH 35-7.5, TH 35-15
Screw clamp	Rigid: Solid/Stranded Flexible without ferrule Flexible with insulated ferrule			Wire stripping length
	Gauge			Tool
Rated current / Rated cross section	17.5 A / 1.5 mm²			Torque
Rated short-time withstand current (1s)	180 A			
Rated voltage	800 V			
Impulse withstand voltage	6000 V			
Protection	IP20	NEMA 1		

The connecting capacity data for one Rigid: Solid/Stranded, or one Flexible conductor (when applicable) is a mandatory information required by IEC, UL and CSA standards (Copper conductors). All other data are provided as supplementary information only. For more details, please consult our CB, UL or CSA certificates and technical datasheet available on <http://www.TE.com>

RoHS <input type="checkbox"/>	Gost R <input type="checkbox"/>
-------------------------------	---------------------------------

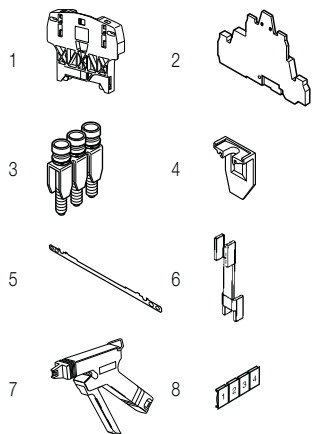

Accessories

Description	Color	Type	Part Number	Pkg pce	Weight (1 pce) g
1 End stops 10 mm 0.394 in	Dark grey <input type="checkbox"/>	BAZH1	1SNK900102R0000	20	24.00
2 End sections 5 mm 0.197 in	Grey <input type="checkbox"/>	FED2AD2	1SNA199476R2500	20	7.00
3 Jumper bars 2 poles 32 A		BJMI6-2	1SNA176663R0000	10	4.40
3 poles		BJMI6-3	1SNA176664R0100	10	6.70
4 poles		BJMI6-4	1SNA176665R0200	10	8.90
5 poles		BJMI6-5	1SNA176666R0300	10	11.20
10 poles		BJMI6-10	1SNA176667R0400	10	22.40
4 Circuit separators 0 mm 0 in	Grey <input type="checkbox"/>	SCAD	1SNA196896R0000	10	
5 Shield connectors		CBD2S	1SNA178408R1400	50	
6 Inner deck jumper bars Inner deck jumper bars		ITVE	1SNA179694R0300	20	1.40
7 Tools Semi automatic tool		OUPAD	1SNA178944R0400	1	205.00
Hand tool		OUMAD	1SNA179466R0600	1	29.00
8 Terminal block markers Blank card	White <input type="checkbox"/>	RC610	1SNA233000R0100	1	7.50

Complete list of accessories is indicated in the terminal block datasheet.

Some accessories such as jumper bars may modify the terminal block's ratings: complete information in the accessories catalogue pages.

Technical data valid for copper conductors only.

D1/5.SNT2.ADO IDC terminal blocks

Disconnect with blade - with test socket ADO - ADO - 5 mm 0.197 in spacing

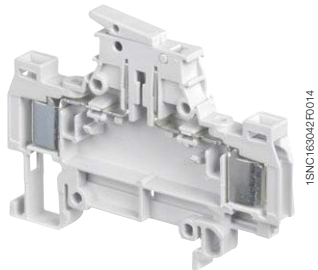

D1/5.SNT2.ADO

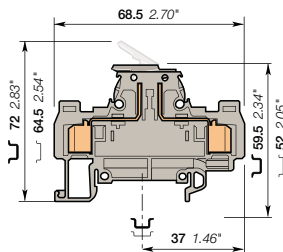

Description

- Ease your disconnect operations with the disconnect knife blade operated by hand,
- With the TE Connectivity ADO System®, experience the fastest and most reliable connection on the market,
- Designed for control applications exposed to severe constrains (vibrations, shocks, corrosion etc.),
- Up to 2 wires per connection.

Ordering details

Description	Color	Type	Part Number	Pkg pce	Weight (1 pce) g
Disconnect With 2 test sockets DIA 2 mm 0.079 in	Grey <input type="checkbox"/>	D1/5.SNT2.ADO	1SNA399231R0700	50	9.00

Main technical data

		IEC	UL	CSA	Mounting instructions	
ADO	Rigid: Solid/Stranded Flexible without ferrule	0.2-1 mm² 0.22-1 mm²			Rail	TH 35-7.5, TH 35-15
Screw clamp	Rigid: Solid/Stranded Flexible without ferrule Flexible with insulated ferrule Gauge				Wire stripping length	
Rated current / Rated cross section		10 A / 1 mm²			Tool	
Rated short-time withstand current (1s)		120 A			Torque	
Rated voltage		320 V				
Impulse withstand voltage		4000 V				
Protection		IP20	NEMA 1			

The connecting capacity data for one Rigid: Solid/Stranded, or one Flexible conductor (when applicable) is a mandatory information required by IEC, UL and CSA standards (Copper conductors). All other data are provided as supplementary information only. For more details, please consult our CB, UL or CSA certificates and technical datasheet available on <http://www.TE.com>



5 mm 0.197 in spacing

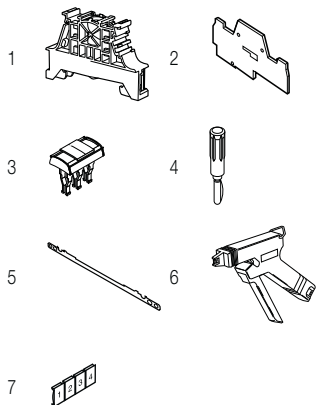

Accessories

Description	Color	Type	Part Number	Pkg pce	Weight (1 pce) g
1 End stops	Dark grey <input type="checkbox"/>	BAM4	1SNK900001R0000	50	14.00
		BAZ1	1SNK900002R0000	50	5.30
2 End sections	Grey <input type="checkbox"/>	FEDAD5	1SNA199354R0200	20	2.70
3 Jumper bars	Orange <input type="checkbox"/>	BJADO5-2	1SNA205955R0300	20	1.00
		BJADO5-3	1SNA205956R0400	20	1.00
		BJADO5-10	1SNA205963R0300	10	5.00
4 Test plugs	Black <input type="checkbox"/>	FC2	1SNA007865R2600	100	
5 Shield connectors		CDB2	1SNA179635R0700	50	
6 Tools		OUPAD	1SNA178944R0400	1	205.00
		OUMAD	1SNA179466R0600	1	29.00
7 Terminal block markers	White <input type="checkbox"/>	RC510	1SNA231000R0700	1	5.20

Complete list of accessories is indicated in the terminal block datasheet.

Some accessories such as jumper bars may modify the terminal block's ratings: complete information in the accessories catalogue pages.

Technical data valid for copper conductors only.

D1.5/6.SNT2.ADO IDC terminal blocks

Disconnect with blade - with test socket ADO - ADO - 6 mm 0.236 in spacing



1.5 mm²
16 AWG

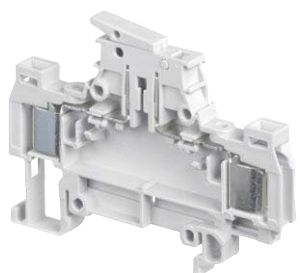

1SN163042R0014

D1.5/6.SNT2.ADO

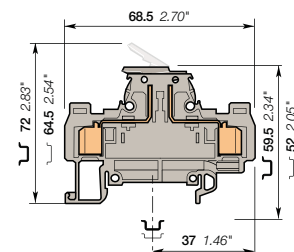

6 mm 0.236 in spacing

Description

- Ease your disconnect operations with the disconnect knife blade operated by hand,
- With the TE Connectivity ADO System®, experience the fastest and most reliable connection on the market,
- Designed for control applications exposed to severe constraints (vibrations, shocks, corrosion etc.),
- Up to 2 wires per connection.

Ordering details

Description	Color	Type	Part Number	Pkg pce	Weight (1 pce) g
Disconnect With 2 test sockets DIA 2 mm 0.079 in	Grey <input type="checkbox"/>	D1.5/6.SNT2.ADO	1SNA199144R2000	50	9.00

Main technical data

		IEC	UL	CSA	Mounting instructions
ADO	Rigid: Solid/Stranded Flexible without ferrule	0.34-1.5 mm ² 0.34-1.5 mm ²	22-14 AWG	22-16 AWG	Rail TH 35-7.5, TH 35-15
Screw clamp	Rigid: Solid/Stranded Flexible without ferrule Flexible with insulated ferrule Gauge				Wire stripping length Tool
Rated current / Rated cross section		10 A / 1.5 mm ²	8 A / 14 AWG	15 A / 16 AWG	Torque
Rated short-time withstand current (1s)		180 A			
Rated voltage		500 V	600 V	600 V	
Impulse withstand voltage		6000 V			
Protection		IP20	NEMA 1		

The connecting capacity data for one Rigid: Solid/Stranded, or one Flexible conductor (when applicable) is a mandatory information required by IEC, UL and CSA standards (Copper conductors). All other data are provided as supplementary information only. For more details, please consult our CB, UL or CSA certificates and technical datasheet available on <http://www.TE.com>

RoHS	ULR	cCSAus	Gost R

Accessories

Description	Color	Type	Part Number	Pkg pce	Weight (1 pce) g
1 End stops	Dark grey <input type="checkbox"/>	BAM4	1SNK900001R0000	50	14.00
		BAZ1	1SNK900002R0000	50	5.30
2 End sections	Grey <input type="checkbox"/>	FEDAD5	1SNA199354R0200	20	2.70
3 Jumper bars	Orange <input type="checkbox"/>	BJADO6-2	1SNA205974R0600	20	1.00
		BJADO6-3	1SNA205975R0700	20	1.00
		BJADO6-10	1SNA205982R2700	10	6.00
4 Test plugs	Black <input type="checkbox"/>	FC2	1SNA007865R2600	100	
5 Shield connectors		CDB2	1SNA179635R0700	50	
6 Tools		OUPAD	1SNA178944R0400	1	205.00
		OUMAD	1SNA179466R0600	1	29.00
7 Terminal block markers	White <input type="checkbox"/>	RC610	1SNA233000R0100	1	7.50

Complete list of accessories is indicated in the terminal block datasheet.

Some accessories such as jumper bars may modify the terminal block's ratings: complete information in the accessories catalogue pages.

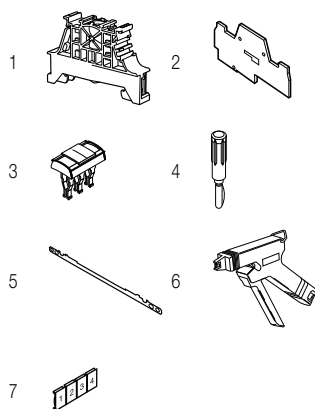

Technical data valid for copper conductors only.

D2.5/8.SNT2.ADO IDC terminal blocks

Disconnect with blade - with test socket ADO - ADO 8 mm 0.315 in spacing



2.5 mm²
14 AWG

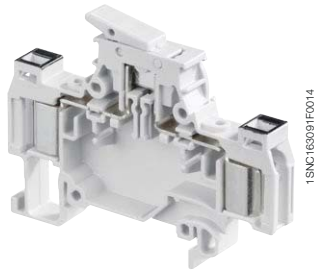

1SNC163091F0014

D2.5/8.SNT2.ADO

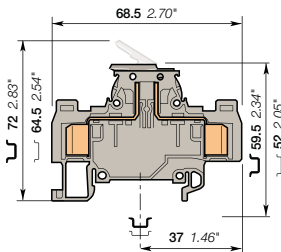

8 mm 0.315 in spacing

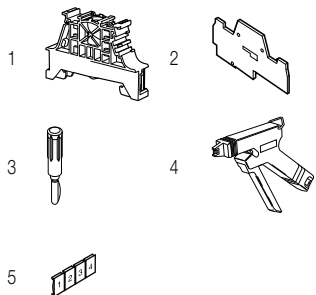

Description

- Ease your disconnect operations with the disconnect knife blade operated by hand,
- With the TE Connectivity ADO System®, experience the fastest and most reliable connection on the market,
- Designed for control applications exposed to severe constrains (vibrations, shocks, corrosion etc.),
- Up to 2 wires per connection.

Ordering details

Description	Color	Type	Part Number	Pkg	Weight
Disconnect With 2 test sockets DIA 2 mm 0.079 in With black marking for wire size 1-2.5 mm ² (16-14 AWG)	Grey <input type="checkbox"/>	D2.5/8.SNT2.ADO	1SNA199231R2700	pce 50	(1 pce) g 12.00

Main technical data

		IEC	UL	CSA		
ADO	Rigid: Solid/Stranded Flexible without ferrule Flexible with ferrule	1-2.5 mm ² 1-2.5 mm ²	16-14 AWG	16-14 AWG	Rail	TH 35-7.5, TH 35-15
Screw clamp	Rigid: Solid/Stranded Flexible without ferrule Flexible with insulated ferrule Gauge				Wire stripping length	
Rated current / Rated cross section		15 A / 2.5 mm ²	15 A / 14 AWG	15 A / 14 AWG	Tool	
Rated short-time withstand current (1s)		300 A			Torque	
Rated voltage		500 V	600 V	600 V		
Impulse withstand voltage		6000 V				
Protection		IP20	NEMA 1			

The connecting capacity data for one Rigid: Solid/Stranded, or one Flexible conductor (when applicable) is a mandatory information required by IEC, UL and CSA standards (Copper conductors). All other data are provided as supplementary information only. For more details, please consult our CB, UL or CSA certificates and technical datasheet available on <http://www.TE.com>

RoHS	USR	cCSAus	Gost R
------	-----	--------	--------

Accessories

Description	Color	Type	Part Number	Pkg	Weight
1 End stops	Dark grey <input type="checkbox"/>	BAM4	1SNK900001R0000	pce 50	(1 pce) g 14.00
		BAZ1	1SNK900002R0000	pce 50	(1 pce) g 5.30
2 End sections	Grey <input type="checkbox"/>	FEDAD5	1SNA199354R0200	pce 20	(1 pce) g 2.70
3 Test plugs	Black <input type="checkbox"/>	FC2	1SNA007865R2600	pce 100	(1 pce) g -
4 Tools		OUPAD	1SNA178944R0400	pce 1	(1 pce) g 205.00
		OUMAD	1SNA179466R0600	pce 1	(1 pce) g 29.00
5 Terminal block markers	White <input type="checkbox"/>	RC810	1SNA234000R0200	pce 1	(1 pce) g 8.20

Complete list of accessories is indicated in the terminal block datasheet.

Some accessories such as jumper bars may modify the terminal block's ratings: complete information in the accessories catalogue pages.

Technical data valid for copper conductors only.

D1.5/8.SF.ADO IDC terminal blocks

For 5 x 20 and 5 x 25 fuses - with test socket ADO - ADO - 8 mm 0.315 in spacing



D1.5/8.SF.ADO

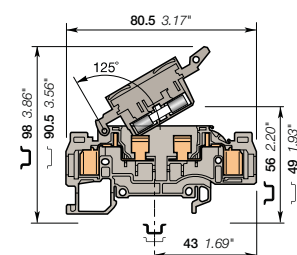

8 mm 0.315 in spacing

Description

- The TE Connectivity ADO System® fuse holders provide circuit protection for control applications,
- With the TE Connectivity ADO System®, experience the fastest and most reliable connection on the market,
- Designed for control applications exposed to severe constraints (vibrations, shocks, corrosion etc.),
- Up to 2 wires per connection.

Ordering details

Description	Color	Type	Part Number	Pkg pce	Weight (1 pce) g
Fuse With 2 test sockets DIA 2 mm 0.079 in or DIA 2.3 mm 0.091 in	Grey <input type="checkbox"/>	D1.5/8.SFT.ADO	1SNA199208R1100	50	13.00

Main technical data

	IEC	UL	CSA	Mounting instructions
ADO	Rigid: Solid/Stranded Flexible without ferrule Flexible with ferrule	0.34-1.5 mm² 0.34-1.5 mm²	22-16 AWG 22-16 AWG	Rail TH 35-7.5, TH 35-15 Wire stripping length
Screw clamp	Rigid: Solid/Stranded Flexible without ferrule Flexible with insulated ferrule Gauge			Tool
Rated current / Rated cross section	6.3 A / 1.5 mm²	8 A / 16 AWG	10 A / 16 AWG	Torque
Rated short-time withstand current (1s)	180 A			
Rated voltage	630 V	600 V	600 V	
Impulse withstand voltage	8000 V			
Protection	IP20	NEMA 1		

The connecting capacity data for one Rigid: Solid/Stranded, or one Flexible conductor (when applicable) is a mandatory information required by IEC, UL and CSA standards (Copper conductors). All other data are provided as supplementary information only. For more details, please consult our CB, UL or CSA certificates and technical datasheet available on <http://www.TE.com>

RoHS	RoHS	USR	cCSAus	Gost R

Accessories

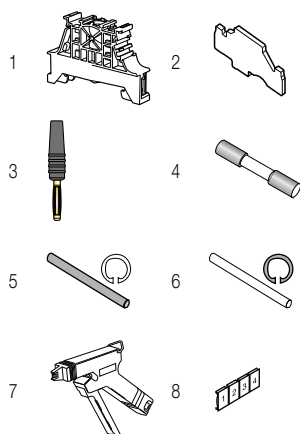

Description	Color	Type	Part Number	Pkg pce	Weight (1 pce) g
1 End stops	Dark grey <input type="checkbox"/>	BAM4	1SNA900001R0000	50	14.00
		BAZ1	1SNA900002R0000	50	5.30
2 End sections	Grey <input type="checkbox"/>	FEDAD7	1SNA199382R2700	20	3.80
3 Test plugs	Black <input type="checkbox"/>	FC2.MC	1SNA107239R0300	20	1.00
4 Fuses		FU520	1SNA008288R1500	10	
			1SNA008290R1300	10	
			1SNA008291R0000	10	
			1SNA008289R1600	10	
			1SNA008292R0100	10	
5 Assembly rods		TGA8	1SNA168672R1100	10	1.00
			1SNA168673R1200	10	
			1SNA168674R1300	10	
6 Spring retaining rings		ANT	1SNA168675R1400	10	
7 Tools		OUPAD	1SNA178944R0400	1	205.00
		OUMAD	1SNA179466R0600	1	29.00
8 Terminal block markers	White <input type="checkbox"/>	RC810	1SNA234000R0200	1	8.20

Complete list of accessories is indicated in the terminal block datasheet. Some accessories such as jumper bars may modify the terminal block's ratings: complete information in the accessories catalogue pages.

Technical data valid for copper conductors only.

D1.5/8.SF.ADO IDC terminal blocks

For 5 x 20 and 5 x 25 fuses - with blown fuse indicator and test socket ADO - ADO - 8 mm 0.315 in spacing

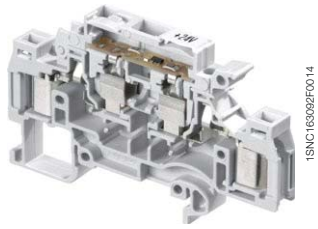

1SNC16302F0014

D1.5/8.SF.ADO

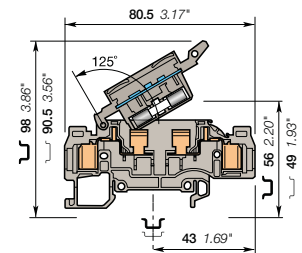

8 mm 0.315 in spacing

Description

- The TE Connectivity ADO System® fuse holders provide circuit protection for control applications,
- Quickly identify the defective circuit thanks to blown fuse indicators,
- With the TE Connectivity ADO System®, experience the fastest and most reliable connection on the market,
- Designed for control applications exposed to severe constrains (vibrations, shocks, corrosion etc.),
- Up to 2 wires per connection.

Ordering details

Description	Color	Type	Part Number	Pkg pce	Weight (1 pce) g
Fuse With blown fuse indicator by neon 110 - 230 V AC and 2 test sockets	Grey <input type="checkbox"/>	D1.5/8.SFLT.ADO	1SNA199211R2300	50	14.00
With blown fuse indicator by LED 24 V AC/DC and 2 test sockets	Grey <input type="checkbox"/>	D1.5/8.SFDT.ADO	1SNA199212R2400	50	14.00

Main technical data

		IEC	UL	CSA	Mounting instructions	
ADO	Rigid: Solid/Stranded Flexible without ferrule	0.34-1.5 mm²	22-16 AWG	22-16 AWG	Rail	TH 35-7.5, TH 35-15
	Flexible without ferrule	0.34-1.5 mm²			Wire stripping length	
Screw clamp	Rigid: Solid/Stranded Flexible without ferrule Flexible with insulated ferrule Gauge				Tool	
Rated current / Rated cross section		6.3 A / 1.5 mm²	8 A / 16 AWG	10 A / 16 AWG	Torque	
Rated short-time withstand current (1s)		180 A				
Rated voltage		500 V	600 V	600 V		
Impulse withstand voltage		6000 V				
Protection		IP20	NEMA 1			

The connecting capacity data for one Rigid: Solid/Stranded, or one Flexible conductor (when applicable) is a mandatory information required by IEC, UL and CSA standards (Copper conductors). All other data are provided as supplementary information only. For more details, please consult our CB, UL or CSA certificates and technical datasheet available on <http://www.TE.com>

RoHS: <input type="checkbox"/>	RoHS <input type="checkbox"/>	USR <input type="checkbox"/>	cCSAus <input type="checkbox"/>	Gost R <input type="checkbox"/>
--------------------------------	-------------------------------	------------------------------	---------------------------------	---------------------------------

Leakage current: 24 V : < 4.5 mA / 110 V : < 0.5 mA / 230 V : < 0.7 mA

Accessories

Description	Color	Type	Part Number	Pkg pce	Weight (1 pce) g
1 End stops	Dark grey <input type="checkbox"/>	BAM4	1SNK900001R0000	50	14.00
		BAZ1	1SNK900002R0000	50	5.30
2 End sections	Grey <input type="checkbox"/>	FEDAD7	1SNA199382R2700	20	3.80
3 Test plugs	Black <input type="checkbox"/>	FC2.MC	1SNA107239R0300	20	1.00
4 Fuses		FU520	1SNA008288R1500	10	
			1SNA008290R1300	10	
			1SNA008291R0000	10	
			1SNA008289R1600	10	
			1SNA008292R0100	10	
5 Assembly rods		TGA8	1SNA168672R1100	10	1.00
			1SNA168673R1200	10	
			1SNA168674R1300	10	
6 Spring retaining rings		ANT	1SNA168675R1400	10	
7 Tools		OUPAD	1SNA178944R0400	1	205.00
		OUMAD	1SNA179466R0600	1	29.00
8 Terminal block markers	White <input type="checkbox"/>	RC810	1SNA234000R0200	1	8.20

Complete list of accessories is indicated in the terminal block datasheet. Some accessories such as jumper bars may modify the terminal block's ratings: complete information in the accessories catalogue pages.

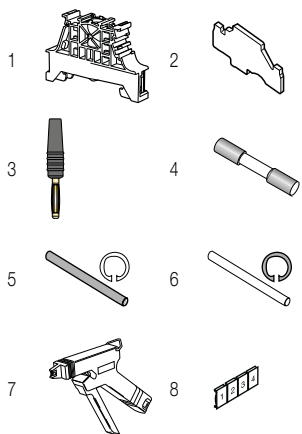

Technical data valid for copper conductors only.

D2.5/8.SF.ADO2 IDC terminal blocks

For 5 x 20 and 5 x 25 fuses - with test socket ADO - ADO - 8 mm 0.315 in spacing



2.5 mm²
14 AWG

Description

- The TE Connectivity ADO System® fuse holders provide circuit protection for control applications,
- With the TE Connectivity ADO System®, experience the fastest and most reliable connection on the market,
- Designed for control applications exposed to severe constraints (vibrations, shocks, corrosion etc.),
- Up to 2 wires per connection.

Ordering details

Description	Color	Type	Part Number	Pkg pce	Weight (1 pce) g
Fuse With 2 test sockets DIA 2 mm 0.079 in or DIA 2.3 mm 0.091 in and black marking for wire size 1-2.5 mm ² (16-14 AWG)	Grey <input type="checkbox"/>	D2.5/8.SFT.ADO2	1SNA199184R1100	50	14.00



D2.5/8.SF.ADO2

Main technical data

	IEC	UL	CSA	Mounting instructions
ADO	Rigid: Solid/Stranded Flexible without ferrule Flexible with ferrule	1-2.5 mm ² 1-2.5 mm ²	16-14 AWG 16-14 AWG	Rail Wire stripping length Tool Torque
Screw clamp	Rigid: Solid/Stranded Flexible without ferrule Flexible with insulated ferrule Gauge			
Rated current / Rated cross section	6.3 A / 2.5 mm ²	10 A / 14 AWG	10 A / 14 AWG	
Rated short-time withstand current (1s)	300 A			
Rated voltage	630 V	600 V	600 V	
Impulse withstand voltage	8000 V			
Protection	IP20	NEMA 1		

The connecting capacity data for one Rigid: Solid/Stranded, or one Flexible conductor (when applicable) is a mandatory information required by IEC, UL and CSA standards (Copper conductors). All other data are provided as supplementary information only. For more details, please consult our CB, UL or CSA certificates and technical datasheet available on <http://www.TE.com>

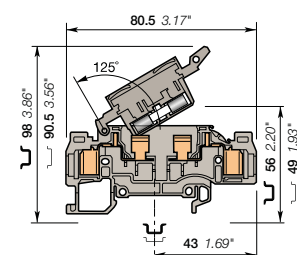

8 mm 0.315 in spacing

RoHS <input type="checkbox"/>	UL <input type="checkbox"/>	cCSAus <input type="checkbox"/>	Gost R <input type="checkbox"/>
RoHS	ULSR	cCSAus	Gost R

Accessories

Description	Color	Type	Part Number	Pkg pce	Weight (1 pce) g
1 End stops	Dark grey <input type="checkbox"/>	BAM4	1SNK900001R0000	50	14.00
		BAZ1	1SNK900002R0000	50	5.30
2 End sections	Grey <input type="checkbox"/>	FEDAD7	1SNA199382R2700	20	3.80
3 Test plugs	Black <input type="checkbox"/>	FC2.MC	1SNA107239R0300	20	1.00
4 Fuses		FU520	1SNA008288R1500	10	
			1SNA008290R1300	10	
			1SNA008291R0000	10	
			1SNA008289R1600	10	
			1SNA008292R0100	10	
5 Assembly rods		TGA8	1SNA168672R1100	10	1.00
			1SNA168673R1200	10	
			1SNA168674R1300	10	
6 Spring retaining rings		ANT	1SNA168675R1400	10	
7 Tools		OUPAD	1SNA178944R0400	1	205.00
		OUMAD	1SNA179466R0600	1	29.00
8 Terminal block markers	White <input type="checkbox"/>	RC810	1SNA234000R0200	1	8.20

Complete list of accessories is indicated in the terminal block datasheet.

Some accessories such as jumper bars may modify the terminal block's ratings: complete information in the accessories catalogue pages.

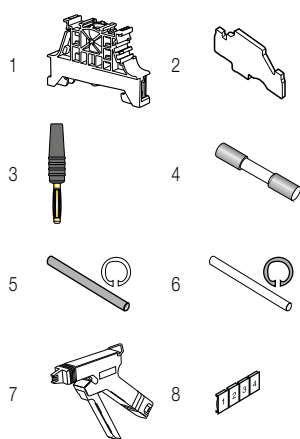

Disconnect IDC terminal blocks

Description	Color	Type	Part Number	Pkg pce	Weight (1 pce) g
Disconnect Profile aligned with D2.5/8.SF.ADO	Grey, blue <input type="checkbox"/>	D2.5/8.SNNT.ADO2	1SNA199186R1300	50	18.00

Technical data valid for copper conductors only.

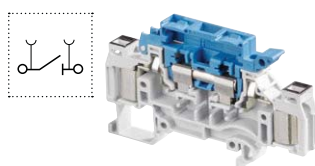

D2.5/8.SF.ADO2 IDC terminal blocks

For 5 x 20 and 5 x 25 fuses - with blown fuse indicator and test socket ADO - ADO - 8 mm 0.315 in spacing



2.5 mm²
14 AWG



1SNC163045F0014

D2.5/8.SF.ADO2

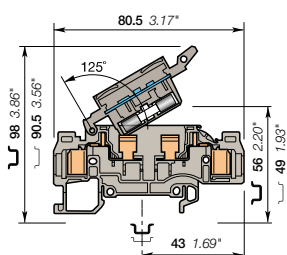

8 mm 0.315 in spacing

Description

- The TE Connectivity ADO System® fuse holders provide circuit protection for control applications,
- Quickly identify the defective circuit thanks to blown fuse indicators,
- With the TE Connectivity ADO System®, experience the fastest and most reliable connection on the market,
- Designed for control applications exposed to severe constraints (vibrations, shocks, corrosion etc.),
- Up to 2 wires per connection.

Ordering details

Description	Color	Type	Part Number	Pkg pce	Weight (1 pce) g
Fuse With blown fuse indicator by neon 110 - 230 V AC and 2 test sockets and black marking for wire size 1-2.5 mm ² (16-14 AWG)	Grey <input type="checkbox"/>	D2.5/8.SFLT.ADO2	1SNA199187R1400	50	15.00
With blown fuse indicator by LED 24 V AC/DC and 2 test sockets and black marking for wire size 1-2.5 mm ² (16-14 AWG)	Grey <input type="checkbox"/>	D2.5/8.SFDT.ADO2	1SNA199188R2500	50	15.00

Main technical data

		IEC	UL	CSA	Mounting instructions	
ADO	Rigid: Solid/Stranded Flexible without ferrule Flexible with ferrule	1-2.5 mm ² 1-2.5 mm ²	16-14 AWG	16-14 AWG	Rail	TH 35-7.5, TH 35-15
Screw clamp	Rigid: Solid/Stranded Flexible without ferrule Flexible with insulated ferrule Gauge				Wire stripping length	
Rated current / Rated cross section		6.3 A / 2.5 mm ²	10 A / 14 AWG	10 A / 14 AWG	Tool	
Rated short-time withstand current (1s)		300 A			Torque	
Rated voltage		500 V	600 V	600 V		
Impulse withstand voltage		6000 V				
Protection		IP20	NEMA 1			

The connecting capacity data for one Rigid: Solid/Stranded, or one Flexible conductor (when applicable) is a mandatory information required by IEC, UL and CSA standards (Copper conductors). All other data are provided as supplementary information only. For more details, please consult our CB, UL or CSA certificates and technical datasheet available on <http://www.TE.com>

RoHS	USR	cCSAus	Gost R
------	-----	--------	--------

Leakage current: 24 V : < 4.5 mA / 110 V : < 0.5 mA / 230 V : < 0.7 mA

Accessories

Description	Color	Type	Part Number	Pkg pce	Weight (1 pce) g
1 End stops	Dark grey <input type="checkbox"/>	BAM4	1SNK900001R0000	50	14.00
		BAZ1	1SNK900002R0000	50	5.30
2 End sections	Grey <input type="checkbox"/>	FEDAD7	1SNA199382R2700	20	3.80
3 Test plugs	Black <input type="checkbox"/>	FC2.MC	1SNA107239R0300	20	1.00
4 Fuses		FU520	1SNA008288R1500	10	
			1SNA008290R1300	10	
			1SNA008291R0000	10	
			1SNA008289R1600	10	
			1SNA008292R0100	10	
5 Assembly rods		TGA8	1SNA168672R1100	10	1.00
			1SNA168673R1200	10	
			1SNA168674R1300	10	
6 Spring retaining rings		ANT	1SNA168675R1400	10	
7 Tools		Semi automatic tool	OUPAD	1	205.00
		Hand tool	OUMAD	1	29.00
8 Terminal block markers	White <input type="checkbox"/>	RC810	1SNA234000R0200	1	8.20

Complete list of accessories is indicated in the terminal block datasheet.

Some accessories such as jumper bars may modify the terminal block's ratings: complete information in the accessories catalogue pages.

Disconnect IDC terminal blocks

Description	Color	Type	Part Number	Pkg pce	Weight (1 pce) g
Disconnect Profile aligned with D2.5/8.SF.ADO	Grey, blue <input type="checkbox"/>	D2.5/8.SNNT.ADO2	1SNA199186R1300	50	18.00

Technical data valid for copper conductors only.

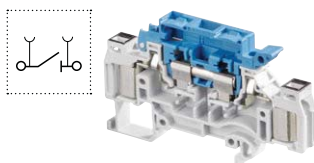
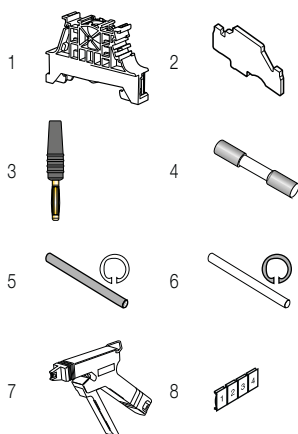

D2.5/8.SNNT.ADO2 IDC terminal blocks

Disconnect - with test socket ADO - ADO - 8 mm 0.315 in spacing



2.5 mm²
14 AWG

Description

- Disconnect terminal blocks aligned with fuse holder terminal blocks,
- With the TE Connectivity ADO System®, experience the fastest and most reliable connection on the market,
- Designed for control applications exposed to severe constraints (vibrations, shocks, corrosion etc.),
- Up to 2 wires per connection.

Ordering details

Description	Color	Type	Part Number	Pkg pce	Weight (1 pce) g
Disconnect With 2 test sockets DIA 2 mm 0.079 in and black marking for wire size 1-2.5 mm ² (16-14 AWG)	Grey, blue	D2.5/8.SNNT.ADO2	1SNA199186R1300	50	18.00

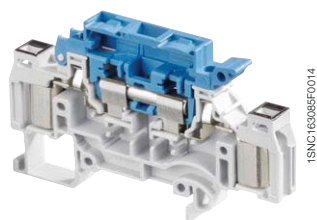

D2.5/8.SNNT.ADO2

Main technical data

	IEC	UL	CSA	Mounting instructions
ADO	Rigid: Solid/Stranded Flexible without ferrule Flexible with ferrule	1-2.5 mm ² 1-2.5 mm ²	16-14 AWG	Rail TH 35-7.5, TH 35-15 Wire stripping length
Screw clamp	Rigid: Solid/Stranded Flexible without ferrule Flexible with insulated ferrule Gauge			Tool
Rated current / Rated cross section	10 A / 2.5 mm ²	10 A / 14 AWG		Torque
Rated short-time withstand current (1s)	300 A			
Rated voltage	630 V	600 V		
Impulse withstand voltage	8000 V			
Protection	IP20	NEMA 1		

The connecting capacity data for one Rigid: Solid/Stranded, or one Flexible conductor (when applicable) is a mandatory information required by IEC, UL and CSA standards (Copper conductors). All other data are provided as supplementary information only. For more details, please consult our CB, UL or CSA certificates and technical datasheet available on <http://www.TE.com>

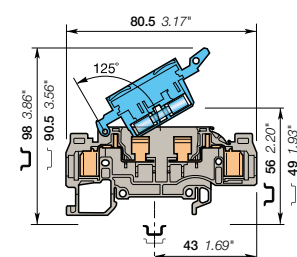

8 mm 0.315 in spacing

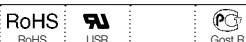

Accessories

Description	Color	Type	Part Number	Pkg pce	Weight (1 pce) g
1 End stops	Dark grey	BAM4	1SNK900001R0000	50	14.00
		BAZ1	1SNK900002R0000	50	5.30
2 End sections	Grey	FEDAD7	1SNA199382R2700	20	3.80
3 Test plugs	Black	FC2.MC	1SNA107239R0300	20	1.00
4 Assembly rods		TGA8	1SNA168672R1100	10	1.00
			1SNA168673R1200	10	
			1SNA168674R1300	10	
5 Spring retaining rings		ANT	1SNA168675R1400	10	
6 Tools		OUPAD	1SNA178944R0400	1	205.00
		OUMAD	1SNA179466R0600	1	29.00
7 Terminal block markers	White	RC810	1SNA234000R0200	1	8.20

Complete list of accessories is indicated in the terminal block datasheet.
Some accessories such as jumper bars may modify the terminal block's ratings: complete information in the accessories catalogue pages.

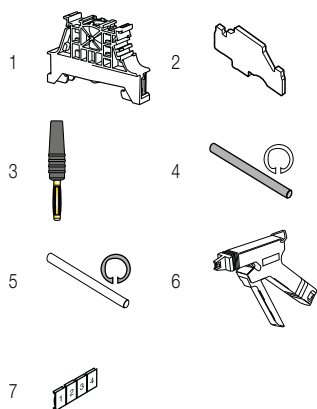

Fuse IDC terminal blocks

Description	Color	Type	Part Number	Pkg pce	Weight (1 pce) g
Fuse Profile aligned with D2.5/8.SNNT.ADO	Grey	D2.5/8.SFT.ADO2	1SNA199184R1100	50	14.00

Technical data valid for copper conductors only.

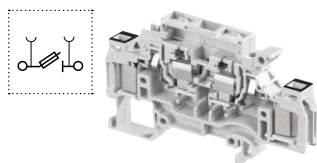

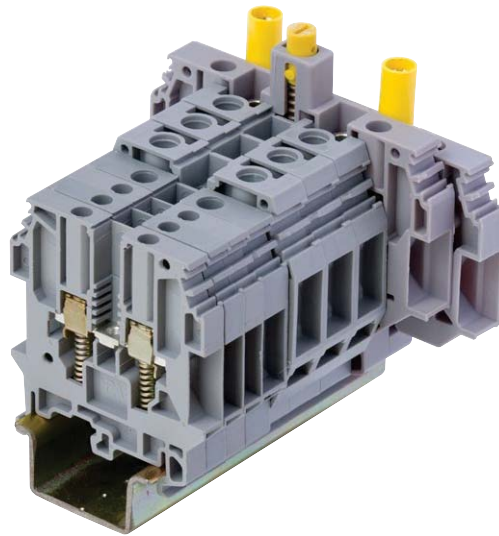

Dedicated applications terminal blocks

Spring loaded screw clamp technology

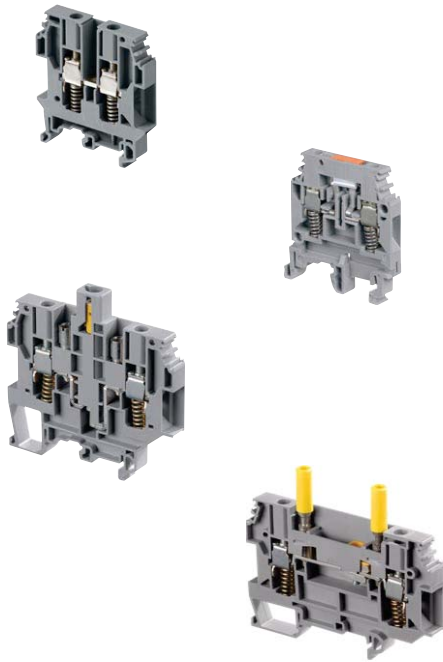

Technologies presentation	60
Overview	62

Feed-through

4 mm ² / 12 AWG	M4/6.RS	63
6 mm ² / 12 AWG	M6/8.RS	64
10 mm ² / 6 AWG	M10/10.RS	65

Disconnect with blade

4 mm ² / 10 AWG	M4/6.SNTS	66
----------------------------	------------------	----

Disconnect with push-turn knob

6 mm ² / 12 AWG	M6/8.STP.RS	With test	67
----------------------------	--------------------	-----------	----

Disconnect with screwdriver sliding link

6 mm ² / 12 AWG	D6/8.ST.RS	68	
	D6/8.ST1.RS.IP20	With insulated test sockets	69

Dedicated applications terminal blocks

Spring loaded screw clamp technology



The safest screw connection!

TE connectivity screw clamp spring loaded technology offers additional contact safety thanks to the combination of a spring under clamp preventing screw loosening and the use of special hook type ferrules providing pull-out proof termination.

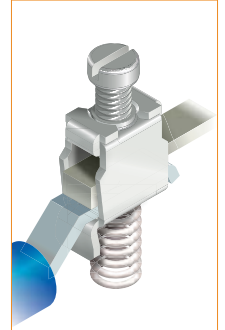

Approved by numerous national electricity providers in EU, Africa and Asia since many years.
Comply with IEC and BS TS5018 standards.



RoHS



ISO 9001
ISO 14001



The ultimate protection against unwanted opened circuits

Safety first!

Connection of up to **two hook type ferrules** onto screw clamp & conducting bar provide "**pull-out proof**" cable terminations.

Circuit continuity ensured

Reinforcement spring beneath the clamp maintains **permanent** contact pressure even if screw clamp is loose ensuring **long term security** of cable connections and electrical circuits.

Robust designed

Springs firmly positioned in **deep recesses** and cannot be easily removed or ejected.

Multiple plastic "ribs" compensate spring pressure and **avoid bending effect on body** leading to a **robust** terminal block body construction.

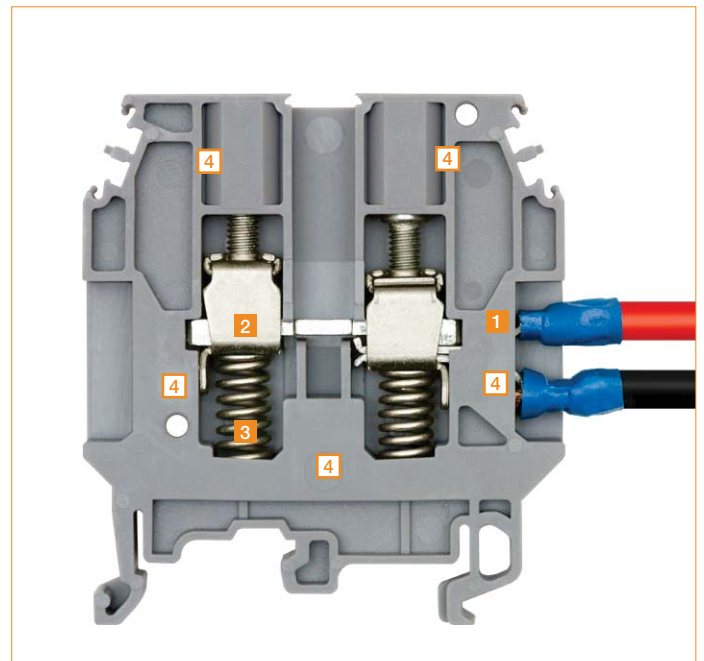

1 Hook type ferrule locked in clamp

2 Permanent contact pressure

3 Deep recesses spring position

4 Multiple reinforcements

1SNC161122S0201

TE connectivity spring loaded screw clamp technology

The safety connection for demanding working conditions

Exclusive design provide robustness and connection safety

The TE connectivity screw clamp spring loaded terminal is designed to guaranty electrical continuity even when screw are loosened unintentionally. It features all the benefits of our screw clamp with additional vibration, shock resistant and maintenance free performances.

High density wiring

The screw clamp spring loaded terminal can fit up to two conductors equipped with bent ferrules per clamp.

Features

The TE connectivity exclusive anti-release system creates a controlled locking-screw effect thanks to the 2 overlapping tabs that maintain the clamp parts. The screw is locked in total safety. The retightening campaigns are not needed anymore!

The clamp is punched, which increases the number of screw threads by 30 % meaning a high torque resistance

Hook type ferrule Provide pull-out proof connection

Hardened steel makes the connection very reliable

Powerfull steel spring underneath Clamp ensures pemanent contact pressure

The screw tightens the conductive bar to the cable. There is no torsion effect applied to the cable

Flap avoiding the insertion of cable underneath the clamp

Screw

Screw clamp

Conductive linking bar

Stripped wire

Spring

Hook type ferrule

From 0.22 mm² up to 10 mm²
From 24 AWG up to 6 AWG

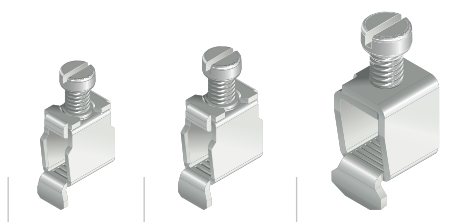

Dedicated applications terminal blocks

Spring loaded screw clamp technology



Feed-through



Disconnect with blade







Disconnect with push-turn knob



Disconnect with screwdriver sliding link

Section

IEC	UL/CSA				
4 mm ²	12 AWG	M4/6.RS 6 mm 0.236 in	M4/6.SNTS 6 mm 0.236 in		
6 mm ²	12 AWG	M6/8.RS 8 mm 0.315 in		M6/8.STP.RS 8 mm 0.315 in	D6/8.ST.RS 8 mm 0.315 in
10 mm ²	6 AWG	M10/10.RS 10 mm 0.394 in			

M4/6.RS spring loaded screw clamp terminal blocks

Feed-through - 6 mm 0.236 in spacing

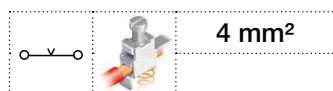

4 mm²

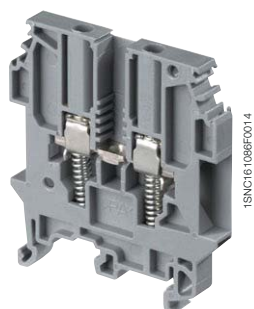

M4/6.RS

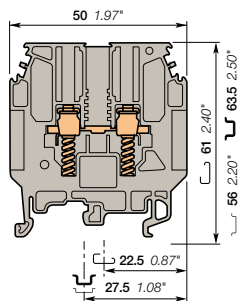

6 mm 0.236 in spacing

Description

- Mainly dedicated to energy applications based on BS TS5018 standard ,
- Security: specific shape in linking bar to lock the hook type ferrule, spring clamp can maintain contact pressure even if screw clamp is loose.

Ordering details

Description	Color	Type	Part Number	Pkg pce	Weight (1 pce) g
Feed-through	Grey	M4/6.RS	1SNA115930R1300	50	11.00
	Blue	M4/6.N.RS	1SNA125930R1500	50	11.00

Main technical data

		IEC	BS	CSA	Mounting instructions	
			TS 5018		Rail	
1 conductor per clamp	Rigid: Solid/Stranded	0.2-4 mm ²			 G32, TH 35-7.5, TH 35-15	
	Flexible without ferrule	0.22-4 mm ²				
	Flexible with insulated ferrule		0.28-1.65 mm ²		 13 mm 0.51 in	
	Gauge	A3				
Rated current / Rated cross section		32 A / 4 mm ²	25 A		 Flat screwdriver Ø 4 mm Ø 0.157 in	
Rated short-time withstand current (1s)		480 A				
Rated voltage		1000 V	500 V		 Torque 0.5 - 0.8 Nm 4.4 - 7.1 lb.in	
Impulse withstand voltage		8000 V				
Protection		IP20	NEMA 1			

The connecting capacity data for one Rigid: Solid/Stranded, or one Flexible conductor (when applicable) is a mandatory information required by IEC, UL and CSA standards (Copper conductors). All other data are provided as supplementary information only. For more details, please consult our CB, UL or CSA certificates and technical datasheet available on <http://www.TE.com>

--	--	--	--	--	--	--	--	--	--

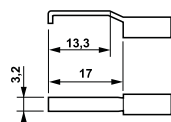

Each screw clamp holds up to 2 hook type ferrules as shown (not supplied)

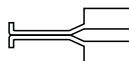

Accessories

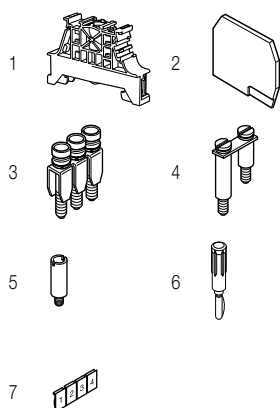

Description		Color	Type	Part Number	Pkg pce	Weight (1 pce) g
1 End stops	10 mm	Dark grey	BAM4	1SNK900001R0000	50	14.00
	5.2 mm		BAZ1	1SNK900002R0000	50	5.30
2 End sections	2.8 mm	Grey	FEMR8	1SNA116987R0200	10	3.00
3 Jumper bars	2 poles		BJMI6-2	1SNA176663R0000	10	4.40
	3 poles		BJMI6-3	1SNA176664R0100	10	6.70
	4 poles		BJMI6-4	1SNA176665R0200	10	8.90
	5 poles		BJMI6-5	1SNA176666R0300	10	11.20
	10 poles		BJMI6-10	1SNA176667R0400	10	22.40
4 Cross spacing jumpers	Universal screw jumper bar kit N°IV		BJDP4	1SNA174781R2500	10	5.00
5 Test sockets	DIA 2 mm 0.079 in		AL2	1SNA163043R2100	50	0.90
6 Test plugs	DIA 2 mm 0.079 in	Black	FC2	1SNA007865R2600	100	
7 Terminal block markers	Blank card	White	RC610	1SNA233000R0100	1	7.50

Complete list of accessories is indicated in the terminal block datasheet.

Some accessories such as jumper bars may modify the terminal block's ratings: complete information in the accessories catalogue pages.

Note: Use of jumper bars or cross spacing jumpers requires the user to cut the partition.

Technical data valid for copper conductors only.

3

1SNC161056S0201 - Rev. B

M6/8.RS spring loaded screw clamp terminal blocks

Feed-through - 8 mm 0.315 in spacing

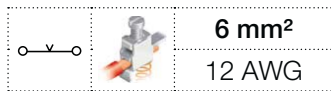

M6/8.RS

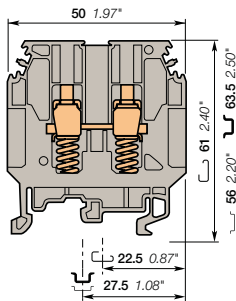

8 mm 0.315 in spacing

Description

- Mainly dedicated to energy applications based on BS TS5018 standard,
- Security: specific shape in linking bar to lock the hook type ferrule, spring clamp can maintain contact pressure even if screw clamp is loose.

Ordering details

Description	Color	Type	Part Number	Pkg pce	Weight (1 pce) g
Feed-through	Grey <input type="checkbox"/>	M6/8.RS	1SNA115685R1200	50	17.00

Main technical data

	IEC	BS TS 5018	CSA
1 conductor per clamp	Rigid: Solid/Stranded	0.5-10 mm ²	20-12 AWG
	Flexible without ferrule	0.5-6 mm ²	
	Flexible with insulated ferrule		0.28-2.5 mm ²
	Gauge	A5	
Rated current / Rated cross section	41 A / 6 mm ²	25 A	25 A / 12 AWG
Rated short-time withstand current (1s)	720 A		
Rated voltage	800 V	500 V	600 V
Impulse withstand voltage	8000 V		
Protection	IP20	NEMA 1	

Mounting instructions

Rail		G32, TH 35-7.5, TH 35-15
Wire stripping length		13 mm 0.51 in
Tool		Flat screwdriver Ø 4 - 5 mm Ø 0.157 - 0.197 in
Torque		0.8 - 1 Nm 7.1 - 8.9 lb.in

The connecting capacity data for one Rigid: Solid/Stranded, or one Flexible conductor (when applicable) is a mandatory information required by IEC, UL and CSA standards (Copper conductors). All other data are provided as supplementary information only. For more details, please consult our CB, UL or CSA certificates and technical datasheet available on <http://www.TE.com>

--	--	--	--	--	--	--	--	--	--

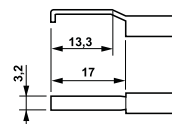

Each screw clamp holds up to 2 hook type ferrules as shown (not supplied)

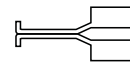

Accessories

Description	Color	Type	Part Number	Pkg pce	Weight (1 pce) g		
1 End stops	Dark grey <input type="checkbox"/>	BAM4	1SNK900001R0000	50	14.00		
		BAZ1	1SNK900002R0000	50	5.30		
2 End sections	Grey <input type="checkbox"/>	FEMR8	1SNA116987R0200	10	3.00		
3 Jumper bars		2 poles	41 A	BJM18-2	1SNA176669R1800	10	4.50
		3 poles		BJM18-3	1SNA176670R1300	10	6.00
		4 poles		BJM18-4	1SNA176671R0000	10	10.00
		5 poles		BJM18-5	1SNA176672R0100	10	12.22
		10 poles		BJM18-10	1SNA176673R0200	10	20.00
4 Test sockets		AL4-M3-R1	1SNA206722R0200	50	1.62		
5 Test plugs	White <input type="checkbox"/>	FC4	1SNA167860R0100	10	10.00		
6 Short circuit plugs		BP8.A4	1SNA173888R2000	10			
7 Terminal block markers	White <input type="checkbox"/>	RC810	1SNA234000R0200	1	8.20		

Complete list of accessories is indicated in the terminal block datasheet.

Some accessories such as jumper bars may modify the terminal block's ratings: complete information in the accessories catalogue pages.

Note: Use of jumper bars requires the user to cut the partition.

Technical data valid for copper conductors only.

M10/10.RS spring loaded screw clamp terminal blocks

Feed-through - 10 mm 0.394 in spacing



10 mm²
6 AWG

Description

- Mainly dedicated to energy applications based on BS TS5018 standard,
- Security: specific shape in linking bar to lock the hook type ferrule, spring clamp can maintain contact pressure even if screw clamp is loose.

Ordering details

Description	Color	Type	Part Number	Pkg pce	Weight (1 pce) g
Feed-through	Grey <input type="checkbox"/>	M10/10.RS	1SNA115320R2700	25	30.00

Main technical data

		IEC	BS TS 5018	CSA
1 conductor per clamp	Rigid: Solid/Stranded	0.5-16 mm ²		20-6 AWG
	Flexible without ferrule	0.5-10 mm ²		
	Flexible with insulated ferrule		0.28-6 mm ²	
Gauge		A5		
Rated current / Rated cross section		41 A / 10 mm ²	40 A	65 A / 6 AWG
Rated short-time withstand current (1s)		1200 A		
Rated voltage		800 V	500 V	600 V
Impulse withstand voltage		8000 V		
Protection		IP20	NEMA 1	

Mounting instructions

Rail		G32, TH 35-7.5, TH 35-15
Wire stripping length		14 mm 0.55 in
Tool		Flat screwdriver Ø 5.5 - 6 mm Ø 0.217 - 0.236 in
Torque		1.2 - 1.4 Nm 10.6 - 12.3 lb.in

The connecting capacity data for one Rigid: Solid/Stranded, or one Flexible conductor (when applicable) is a mandatory information required by IEC, UL and CSA standards (Copper conductors). All other data are provided as supplementary information only. For more details, please consult our CB, UL or CSA certificates and technical datasheet available on <http://www.TE.com>

--	--	--	--	--	--	--	--	--	--	--	--	--	--	--	--	--	--	--	--	--

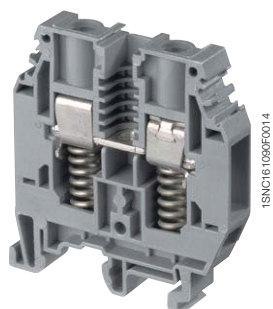

M10/10.RS

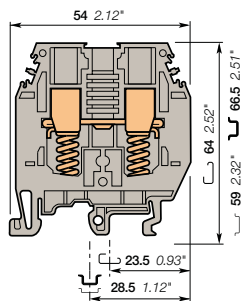

10 mm 0.394 in spacing

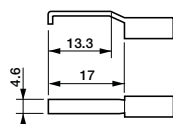

Each screw clamp holds up to 2 hook type ferrules as shown (not supplied)

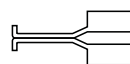

Accessories

Description	Color	Type	Part Number	Pkg pce	Weight (1 pce) g	
1 End stops	Dark grey <input type="checkbox"/>	BAM4	1SNK900001R0000	50	14.00	
		BAZ1	1SNK900002R0000	50	5.30	
2 End sections	Grey <input type="checkbox"/>	FEMR10	1SNA114434R0500	10	3.30	
3 Jumper bars (1)		2 poles	BJS10	1SNA164585R1700	10	17.00
		3 poles		1SNA164586R1000	10	17.00
		4 poles		1SNA164587R1100	10	17.00
		5 poles		1SNA168273R1100	10	17.00
		10 poles		1SNA164588R2200	10	17.00
		20 poles		BJS10-20	1SNA177654R0000	10
4 Posts (1)		PT101	1SNA163181R1100	50	1.00	
5 Screws (1)		VSJ11	1SNA163394R2600	50	0.60	
6 Test sockets		AL4-M4	1SNA206723R0300	50	1.30	
7 Test plugs	White <input type="checkbox"/>	FC4	1SNA167860R0100	10	10.00	
8 Terminal block markers	White <input type="checkbox"/>	RC1010	1SNA238000R1600	1	1.30	

Complete list of accessories is indicated in the terminal block datasheet.
Some accessories such as jumper bars may modify the terminal block's ratings: complete information in the accessories catalogue pages.
Note: Use of jumper bars requires the user to cut the partition.
(1) Complete jumper : jumper bar + post x number of poles + screw x number of poles.

Technical data valid for copper conductors only.

M4/6.SNTS spring loaded screw clamp terminal blocks

Disconnect with blade - with test socket - 6 mm 0.236 in spacing

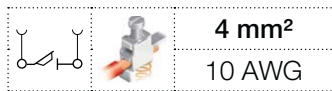

M4/6.SNTS

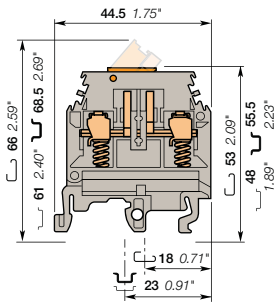

6 mm 0.236 in spacing

Description

- Mainly dedicated to energy markets for security purposes on CT circuits,
- Security: specific shape in linking bar to lock the ferrule, spring clamp can maintain contact pressure even if screw clamp is loose.

Ordering details

Description	Color	Type	Part Number	Pkg pce	Weight (1 pce) g
Disconnect With test socket DIA 2 mm 0.079 in	Grey <input type="checkbox"/>	M4/6.SNTS	1SNA115229R2000	50	11.00

Main technical data

		IEC	UL	CSA	Mounting instructions	
1 conductor per clamp	Rigid: Solid/Stranded	0.5-4 mm ²	22-10 AWG	24-10 AWG	Rail	G32, TH 35-7.5, TH 35-15
	Flexible without ferrule	0.5-4 mm ²			Wire stripping length	9.5 mm 0.374 in
	Flexible with insulated ferrule				Tool	Flat screwdriver Ø 4 mm Ø 0.157 in
	Gauge				Torque	0.5 - 0.6 Nm 4.4 - 5.3 lb.in
Rated current / Rated cross section		10 A / 4 mm ²	10 A / 10 AWG	15 A / 10 AWG		
Rated short-time withstand current (1s)		480 A				
Rated voltage		500 V	300 V	600 V		
Impulse withstand voltage						
Protection		IP20	NEMA 1			

The connecting capacity data for one Rigid: Solid/Stranded, or one Flexible conductor (when applicable) is a mandatory information required by IEC, UL and CSA standards (Copper conductors). All other data are provided as supplementary information only. For more details, please consult our CB, UL or CSA certificates and technical datasheet available on <http://www.TE.com>

--	--	--	--	--	--	--

Accessories

Description	Color	Type	Part Number	Pkg pce	Weight (1 pce) g
1 End stops	Dark grey <input type="checkbox"/>	BAM4	1SNK900001R0000	50	14.00
		BAZ1	1SNK900002R0000	50	5.30
2 End sections	Grey <input type="checkbox"/>	FEM6	1SNA118368R1600	20	2.40
3 Jumper bars	Grey <input type="checkbox"/>	AD2.5	1SNA114205R2000	50	1.60
4 Lateral jumper bars		PC61-10	1SNA163311R2200	10	5.00
5 Circuit separators	Grey <input type="checkbox"/>	SCFM6	1SNA114825R0500	20	4.00
		SCF6	1SNA118707R0300	20	
6 Test plugs	Black <input type="checkbox"/>	FC2	1SNA007865R2600	100	
7 Shield connectors		CBM5	1SNA178745R1400	50	
8 Terminal block markers	White <input type="checkbox"/>	RC610	1SNA233000R0100	1	7.50

Complete list of accessories is indicated in the terminal block datasheet. Some accessories such as jumper bars may modify the terminal block's ratings: complete information in the accessories catalogue pages.

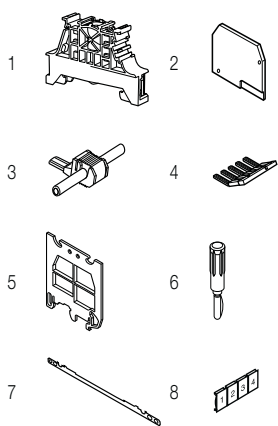

Technical data valid for copper conductors only.

M6/8.STP.RS spring loaded screw clamp terminal blocks

Disconnect with push-turn knob - with test socket- 8 mm 0.315 in spacing

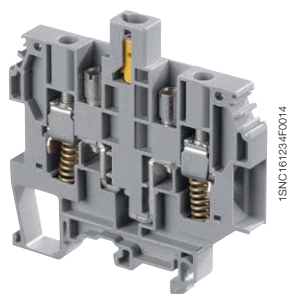
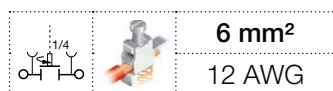

M6/8.STP.RS

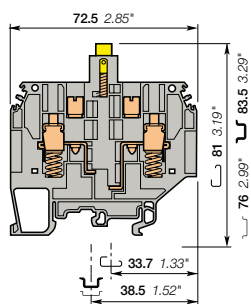

8 mm 0.315 in spacing

Description

- Mainly dedicated to energy markets for security purposes on CT circuits,
- Security: specific shape in linking bar to lock the ferrule, spring clamp can maintain contact pressure even if screw clamp is loose.

Ordering details

Description	Color	Type	Part Number	Pkg pce	Weight (1 pce) g
Disconnect With 2 test sockets DIA 4 mm 0.157 in	Grey, yellow	M6/8.STP.RS	1SNA115678R0200	25	29.00

Main technical data

	IEC	BS TS 5018	CSA
1 conductor per clamp	Rigid: Solid/Stranded Flexible without ferrule Flexible with insulated ferrule Gauge	0.5-10 mm ² 0.5-6 mm ² A5	20-12 AWG 0.28-2.5 mm ²
Rated current / Rated cross section	24 A / 6 mm ²	25 A	25 A / 12 AWG
Rated short-time withstand current (1s)	720 A		
Rated voltage	500 V	500 V	600 V
Impulse withstand voltage	6000 V		
Protection		NEMA	

Mounting instructions

Rail		G32, TH 35-7.5, TH 35-15
Wire stripping length		13 mm 0.512 in
Tool		Flat screwdriver Ø 4 - 5 mm Ø 0.157 - 0.197 in
Torque		0.8 - 1 Nm 7.1 - 8.9 lb.in

The connecting capacity data for one Rigid: Solid/Stranded, or one Flexible conductor (when applicable) is a mandatory information required by IEC, UL and CSA standards (Copper conductors). All other data are provided as supplementary information only. For more details, please consult our CB, UL or CSA certificates and technical datasheet available on <http://www.TE.com>

--	--	--	--

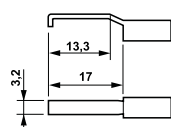

Each screw clamp holds up to 2 hook type ferrules as shown (not supplied)

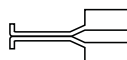

Accessories

Description	Color	Type	Part Number	Pkg pce	Weight (1 pce) g
1 End stops	Dark grey	BAM4	1SNK900001R0000	50	14.00
		BAZ1	1SNK900002R0000	50	5.30
2 End sections	Grey	FEMR8T	1SNA116991R0600	10	4.70
3 Jumper bars	Grey	AD2.5	1SNA114205R2000	50	1.60
4 Test plugs	White	FC4	1SNA167860R0100	10	10.00
5 Short circuit plugs	Red	BP8.A4	1SNA173888R2000	10	10.00
		BNSTP2	1SNA196789R2400	20	14.00
		BNSTP1	1SNA196792R1700	20	14.00
6 Terminal block markers	White	RC810	1SNA234000R0200	1	8.20

Complete list of accessories is indicated in the terminal block datasheet. Some accessories such as jumper bars may modify the terminal block's ratings: complete information in the accessories catalogue pages.

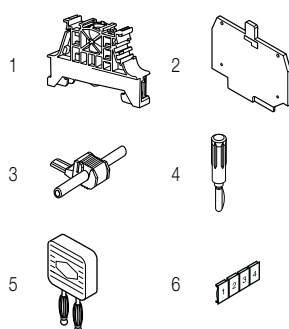

Technical data valid for copper conductors only.

D6/8.ST.RS spring loaded screw clamp terminal blocks

Test disconnect with a screwdriver sliding link - 8 mm 0.315 in spacing



6 mm²

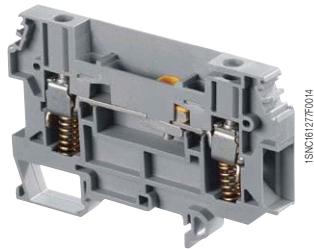

D6/8.ST.RS

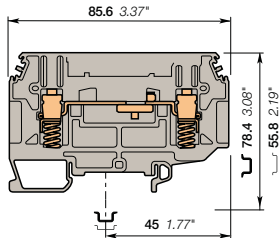

8 mm 0.315 in spacing

Description

- Mainly dedicated to energy markets for security purposes on CT circuits,
- Security: specific shape in linking bar to lock the ferrule, spring clamp can maintain contact pressure even if screw clamp is loose.

Ordering details

Description	Color	Type	Part Number	Pkg pce	Weight (1 pce) g
Disconnect	Grey <input type="checkbox"/>	D6/8.ST.RS	1SNA115914R0700	32	28.00

Main technical data

	IEC	BS TS 5018	CSA
1 conductor per clamp	Rigid: Solid/Stranded	0.5-10 mm ²	
	Flexible without ferrule	0.5-6 mm ²	
	Flexible with insulated ferrule		0.28-2.5 mm ²
	Gauge	A5	
Rated current / Rated cross section	24 A / 6 mm ²		
Rated short-time withstand current (1s)	720 A		
Rated voltage	400 V		
Impulse withstand voltage	6000 V		
Protection	NEMA		

Mounting instructions

Rail		G32, TH 35-7.5, TH 35-15
Wire stripping length		16 mm 0.51 in
Tool		Flat screwdriver Ø 3.5 mm Ø 0.138 in
Torque		0.8 - 1 Nm 7.1 - 8.9 lb.in

The connecting capacity data for one Rigid: Solid/Stranded, or one Flexible conductor (when applicable) is a mandatory information required by IEC, UL and CSA standards (Copper conductors). All other data are provided as supplementary information only. For more details, please consult our CB, UL or CSA certificates and technical datasheet available on <http://www.TE.com>

--	--	--	--	--	--	--	--	--	--

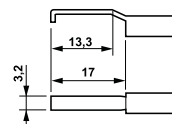

Each screw clamp holds up to 2 hook type ferrules as shown (not supplied)

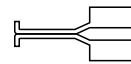

Accessories

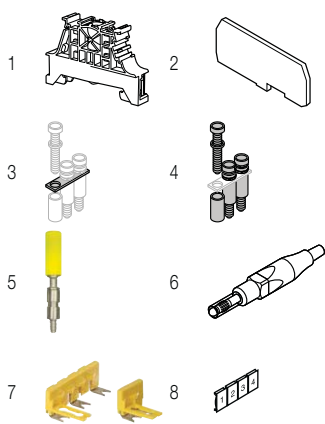

Description	Color	Type	Part Number	Pkg pce	Weight (1 pce) g		
1 End stops	Dark grey <input type="checkbox"/>	BAM4	1SNK900001R0000	50	14.00		
		BAZ1	1SNK900002R0000	50	5.30		
2 End sections	Grey <input type="checkbox"/>	FEM8T6	1SNA215266R0100	10	4.40		
3 Jumper bars		2 poles	41 A	BJS8	1SNA164581R1300	10	3.10
		3 poles			1SNA164582R1400	10	3.10
		4 poles			1SNA164583R1500	10	3.10
		20 poles		BJS8-20	1SNA174789R0500	5	3.20
4 Fastening kits		Sub assembly post + screw + washer	EV6I	1SNA206394R0200	20	2.00	
5 Test sockets	DIA 4 mm 0.157 in IP20	Yellow <input type="checkbox"/>	AJS9	1SNA179726R0200	25	3.60	
		Black <input type="checkbox"/>	AJS9-1	1SNA206680R1500	25	3.60	
		Green <input type="checkbox"/>	AJS9-2	1SNA206681R0200	25	3.60	
		Grey <input type="checkbox"/>	AJS9-3	1SNA206682R0300	25	3.60	
		Blue <input type="checkbox"/>	AJS9-4	1SNA206683R0400	25	3.60	
		Red <input type="checkbox"/>	AJS9-5	1SNA206720R1400	25	3.60	
6 Test plugs	DIA 4 mm 0.157 in IP20	Red <input type="checkbox"/>	FC4-1	1SNA167927R1000	10	11.00	
		Yellow <input type="checkbox"/>	SC-JB8-2	1SNK900652R0000	25	2.00	
7 Short circuit bridges		3 poles	SC-JB8-3	1SNK900653R0000	25	3.40	
		4 poles	SC-JB8-4	1SNK900654R0000	25	4.70	
		Blank card	White <input type="checkbox"/>	RC810	1SNA234000R0200	1	8.20

Complete list of accessories is indicated in the terminal block datasheet.
Some accessories such as jumper bars may modify the terminal block's ratings: complete information in the accessories catalogue pages.

Technical data valid for copper conductors only.

D6/8.ST.RS spring loaded screw clamp terminal blocks

Test disconnect with a screwdriver sliding link - 8 mm 0.315 in spacing

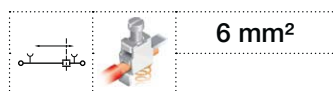

6 mm²

Description

- Mainly dedicated to energy markets for security purposes on CT circuits,
- Security: specific shape in linking bar to lock the ferrule, spring clamp can maintain contact pressure even if screw clamp is loose.

Ordering details

Description	Color	Type	Part Number	Pkg pce	Weight (1 pce) g
Disconnect With 2 yellow test sockets DIA 4 mm 0.157 in	Grey	D6/8.ST1.RS.IP20	1SNA115831R0400	32	38.00

Main technical data

	IEC	BS	CSA	Rail	Wire stripping length	Screw clamp	Tool	Torque	Disconnect device	Tool	Torque	Test socket	Tool	Torque
1 conductor per clamp	Rigid: Solid/Stranded Flexible without ferrule Flexible with insulated ferrule	0.5-10 mm ² 0.5-6 mm ²	TS 5018											
	Gauge	A5												
Rated current / Rated cross section		24 A / 6 mm ²												
Rated short-time withstand current (1s)		720 A												
Rated voltage		400 V												
Impulse withstand voltage		6000 V												
Protection			NEMA											

Mounting instructions

The connecting capacity data for one Rigid: Solid/Stranded, or one Flexible conductor (when applicable) is a mandatory information required by IEC, UL and CSA standards (Copper conductors). All other data are provided as supplementary information only. For more details, please consult our CB, UL or CSA certificates and technical datasheet available on <http://www.TE.com>

CE	RoHS	PC	Gost R
----	------	----	--------



1SNC161233F0014

D6/8.ST.RS

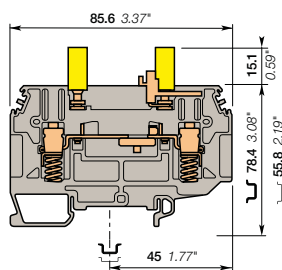

8 mm 0.315 in spacing

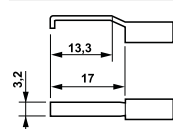

Each screw clamp holds up to 2 hook type ferrules as shown (not supplied)

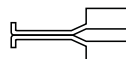

Accessories

Description	Color	Type	Part Number	Pkg pce	Weight (1 pce) g
1 End stops	Dark grey	BAM4	1SNK900001R0000	50	14.00
		BAZ1	1SNK900002R0000	50	5.30
2 End sections	Grey	FEM8T6	1SNA215266R0100	10	4.40
3 Jumper bars	Grey	AD2.5	1SNA114205R2000	50	1.60
4 Test sockets	Black	AJS9-1	1SNA206680R1500	25	3.60
	Green	AJS9-2	1SNA206681R0200	25	3.60
	Grey	AJS9-3	1SNA206682R0300	25	3.60
	Blue	AJS9-4	1SNA206683R0400	25	3.60
	Red	AJS9-5	1SNA206720R1400	25	3.60
5 Test plugs	Red	FC4-1	1SNA167927R1000	10	11.00
6 Short circuit bridges	Yellow	SC-JB8-2	1SNK900652R0000	25	2.00
		SC-JB8-3	1SNK900653R0000	25	3.40
		SC-JB8-4	1SNK900654R0000	25	4.70
7 Terminal block markers	White	RC810	1SNA234000R0200	1	8.20

Complete list of accessories is indicated in the terminal block datasheet.

Some accessories such as jumper bars may modify the terminal block's ratings: complete information in the accessories catalogue pages.

Technical data valid for copper conductors only.

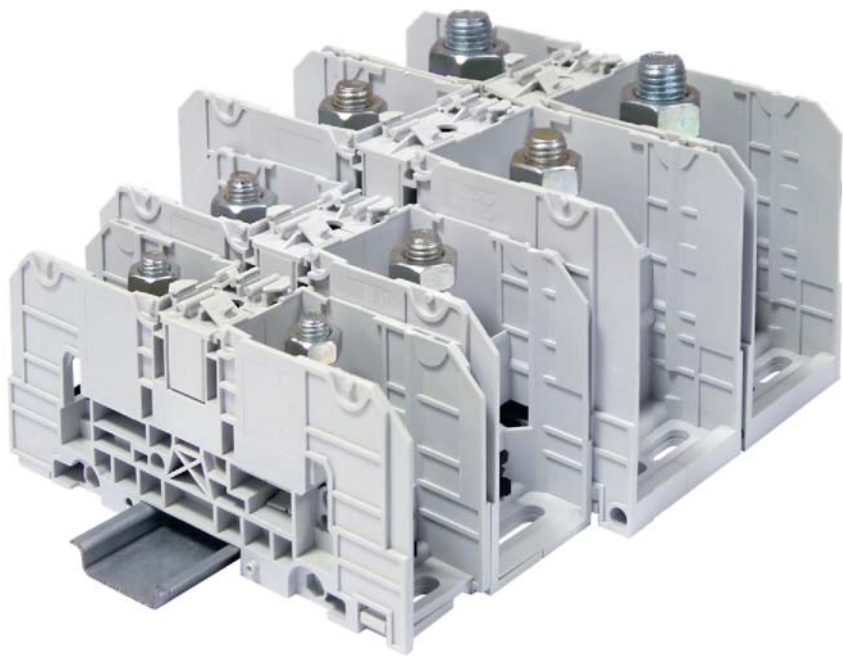

1SNC16503050201

Dedicated applications terminal blocks

Stud technology

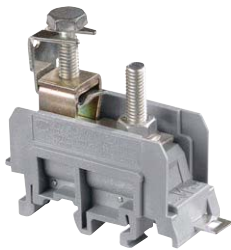
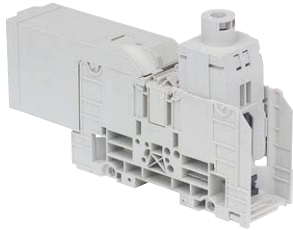

Technologies presentation	72
Overview	73

D... series

Two studs

Feed-through

35 mm ² / 1 AWG	D35/27.FF	74
70 mm ² / 000 AWG	D70/32.FF	75
120 mm ² / 300 Kcmil	D120/42.FF	76
185 mm ² / 500 Kcmil	D185/55.FF	77
300 mm ² / 1000 Kcmil	D300/55.FF	78

One stud - One screw clamp

Feed-through

35 mm ² / 1 AWG	D35/27.AF	79
70 mm ² / 000 AWG	D70/32.AF	80
120 mm ² / 300 AWG	D120/42.AF	81
185 mm ² / 500 AWG	D185/55.AF	82

D... series mounting instructions	83
-----------------------------------	----

M... series

Two studs

Feed-through

25 mm ² / 2 AWG	M35/26.FF	84
50 mm ² / 00 AWG	M70/31.FF	85
70 mm ² / 000 AWG-250 Kcmil	M120/35.FF	86
120 mm ² / 500 Kcmil	M300/42.FF	87

One stud - One screw clamp

Feed-through

25 mm ² / 2 AWG	M35/26.AF	88
50 mm ² / 0 AWG	M70/31.AF	89
70 mm ² / 000 AWG-250 Kcmil	M120/35.AF	90
120 mm ² / 500 Kcmil	M300/42.AF	91

One stud

Feed-through

25 mm ² / 2 AWG	M35/26.F	92
50 mm ² / 00 AWG	M70/31.F	93
70 mm ² / 000 AWG-250 Kcmil	M120/35.F	94
120 mm ² / 500 Kcmil	M300/42.F	95

M... series mounting instructions	96
-----------------------------------	----

TE Connectivity Stud technology

The connection for power and energy circuits

Reliability first

Stud technology is designed to ensure a reliable connection thanks to the combination of:

- Vibration resistant equipments (nuts, washers),
- Lugs crimped on the cable provide pull-out proof termination.

This technology is very popular on the American market and particularly in the energy applications.

Available configurations

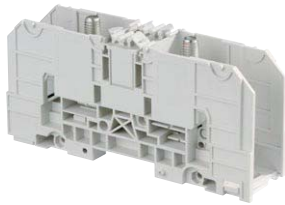

Two studs



One screw clamp / one stud

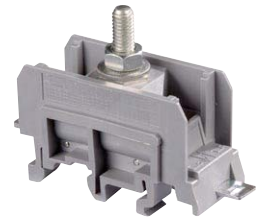

One stud

Connection technics

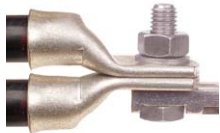

Up to 300 mm² / 1000 Kcmil



M4-M5
6 mm²
8 AWG



M6
35 mm²
1 AWG



M8
70 mm²
000 AWG



M10
120 mm²
300 Kcmil



M12
185 mm²
500 Kcmil



M16
300 mm²
1000 Kcmil

1SNC165028S0201

Dedicated applications terminal blocks

Stud technology

Two studs

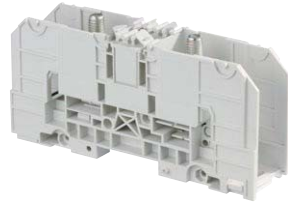

Feed-through

Section

IEC	UL/CSA		
35 mm ²	2 AWG	D35/27.FF	27 mm 1.063 in
70 mm ²	00 AWG	D70/32.FF	32 mm 1.260 in
120 mm ²	000 AWG-250 Kcmil	D120/42.FF	42 mm 1.654 in
185 mm ²	500 Kcmil	D185/55.FF	55 mm 2.165 in
300 mm ²	500 Kcmil	D300/55.FF	55 mm 2.165 in



Feed-through

Section

IEC	UL/CSA		
25 mm ²	2 AWG	M35/26.FF	26 mm 1.024 in
50 mm ²	00 AWG	M70/31.FF	31 mm 1.220 in
70 mm ²	000 AWG-250 Kcmil	M120/35.FF	35 mm 1.380 in
120 mm ²	500 Kcmil	M300/42.FF	42 mm 1.653 in

One stud - One Screw-clamp



Feed-through

Section

IEC	UL/CSA		
35 mm ²	2 AWG	D35/27.AF	27 mm 1.063 in
70 mm ²	00 AWG	D70/32.AF	32 mm 1.260 in
120 mm ²	000 AWG-250 Kcmil	D120/42.AF	42 mm 1.654 in
185 mm ²	500 Kcmil	D185/55.AF	55 mm 2.165 in



Feed-through

Section

IEC	UL/CSA		
25 mm ²	2 AWG	M35/26.AF	26 mm 1.024 in
50 mm ²	0 AWG	M70/31.AF	31 mm 1.220 in
70 mm ²	000 AWG-250 Kcmil	M120/35.AF	35 mm 1.380 in
120 mm ²	500 Kcmil	M300/42.AF	42 mm 1.653 in

One stud



Feed-through

Section

IEC	UL/CSA		
25 mm ²	2 AWG	M35/26.F	26 mm 1.024 in
50 mm ²	00 AWG	M70/31.F	31 mm 1.220 in
70 mm ²	000 AWG-250 Kcmil	M120/35.F	35 mm 1.380 in
120 mm ²	500 Kcmil	M300/42.F	42 mm 1.653 in

D35/27.FF power terminal blocks

Feed-through - 27 mm 1.062 in spacing

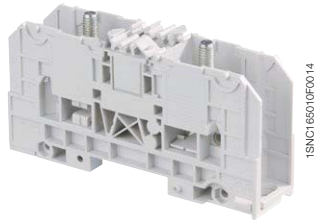

D35/27.FF

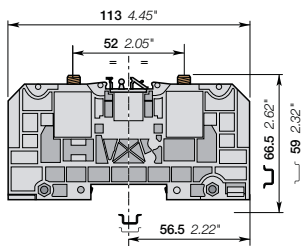

27 mm 1.062 in spacing

Description

- Rated cross section up to 300 mm² / 1000 Kcmil, IP20 protection cover,
- Holding foot on DIN 3 rail with two position for easy mounting, lug mounting in accordance with NF C 20-130 and DIN 46234, various marking options, rail or base mounting.

Ordering details

Description	Color	Type	Part Number	Pkg qty	Weight (1 pce)
Feed-through 2 studs M6 without cover	Grey <input type="checkbox"/>	D35/27.FF	1SNA190001R2000	10	130.00

Main technical data

Connecting capacity		NF C	DIN	UL	CSA
Lugs	Rigid: Solid/Stranded	2.5-35 mm ²	2.5-50 mm ²	1 AWG	
	Flexible with insulated ferrule	2.5-35 mm ²	2.5-35 mm ²		
	Gauge	C4			
Screw clamp	Rigid: Solid/Stranded				
	Flexible without ferrule				
	Gauge				
Bar					
	Rated current	125 A		125 A	
	Rated cross section	35 mm ²		1 AWG	
Rated voltage		1000 V		600 V	
Impulse withstand voltage		8000 V			

Mounting instructions

Rail		TH 35-7.5, TH 35-15
Lugs		Wrench H10 mm
Tool		
Torque		3 - 6 N.m 26.1 - 52 lb.in
Jumper screw		Allen key 6 mm 0.236 in
Tool		
Torque		6 - 12 N.m 52 - 104 lb.in
Screw clamp		
Tool		
Torque		
Wire stripping length		

The connecting capacity data for one Rigid: Solid/Stranded, or one Flexible conductor (when applicable) is a mandatory information required by IEC, UL and CSA standards (Copper conductors). All other data are provided as supplementary information only. For more details, please consult our CB, UL or CSA certificates and technical datasheet available on <http://www.TE.com>

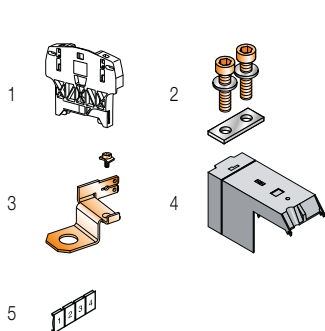

Accessories

Description	Color	Type	Part Number	Pkg qty	Weight (1 pce)
1 End stops 10 mm 0.394 in	Dark grey <input type="checkbox"/>	BAZH1	1SNK900102R0000	20	24.00
2 Jumper bars 2 poles		BJS27-2	1SNA205772R1300	5	34.00
		BJS27-3	1SNA205773R1400	5	52.00
3 Splitters For 6.35x0.8mm faston clips and screws		DRF6	1SNA205767R1600	10	4.00
4 Protecting covers IP20 rotating protecting cover	Grey <input type="checkbox"/>	CPUF35	1SNA190016R1600	2	8.30
5 Terminal block markers Blank card	White <input type="checkbox"/>	RC810	1SNA234000R0200	1	8.20

Complete list of accessories is indicated in the terminal block datasheet.

Some accessories such as jumper bars may modify the terminal block's ratings: complete information in the accessories catalogue pages.

Technical data valid for copper conductors only.

D70/32.FF power terminal blocks

Feed-through - 32 mm 1.260 in spacing

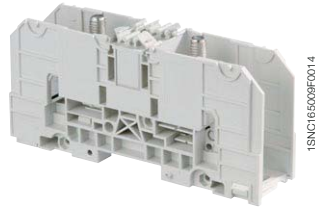

D70/32.FF

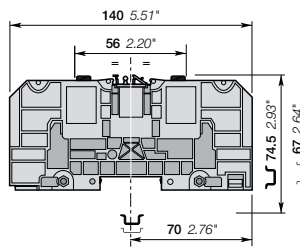

32 mm 1.260 in spacing

Description

- Rated cross section up to 300 mm² / 1000 Kcmil, IP20 protection cover,
- Holding foot on DIN 3 rail with two position for easy mounting, lug mounting in accordance with NF C 20-130 and DIN 46234, various marking options, rail or base mounting.

Ordering details

Description	Color	Type	Part Number	Pkg qty	Weight (1 pce) g
Feed-through 2 studs M8 without cover	Grey <input type="checkbox"/>	D70/32.FF	1SNA190002R2100	3	269.00

Main technical data

Connecting capacity	NF C	DIN	UL	CSA
Lugs				
Rigid: Solid/Stranded	6-95 mm ²	6-70 mm ²	000 AWG	
Flexible with insulated ferrule	6-70 mm ²	6-70 mm ²		
Gauge	C6			
	IEC	UL	CSA	
Screw clamp				
Rigid: Solid/Stranded				
Flexible without ferrule				
Gauge				
	IEC	UL	CSA	
Bar				
Rated current	192 A		170 A	
Rated cross section	70 mm ²		000 AWG	
Rated voltage	1000 V		600 V	
Impulse withstand voltage	8000 V			

Mounting instructions

Rail		TH 35-7.5, TH 35-15
Lugs		Wrench
Tool		H13 mm
Torque		6 - 12 N.m 52 - 104 lb.in
Jumper screw		Allen key
Tool		6 mm 0.236 in
Torque		6 - 12 N.m 52 - 104 lb.in
Screw clamp		
Tool		
Torque		
Wire stripping length		

The connecting capacity data for one Rigid: Solid/Stranded, or one Flexible conductor (when applicable) is a mandatory information required by IEC, UL and CSA standards (Copper conductors). All other data are provided as supplementary information only. For more details, please consult our CB, UL or CSA certificates and technical datasheet available on <http://www.TE.com>

RoHS	UL	PCB	Gost R
RoHS	ULSR CNFR		

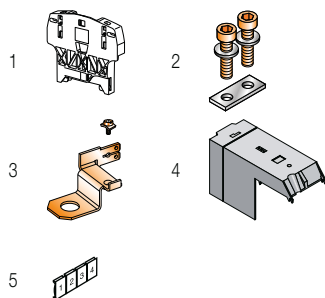

Accessories

Description	Color	Type	Part Number	Pkg qty	Weight (1 pce) g
1 End stops 10 mm 0.394 in	Dark grey <input checked="" type="checkbox"/>	BAZH1	1SNK900102R0000	20	24.00
2 Jumper bars 2 poles		BJS32-2	1SNA205774R1500	5	66.00
3 poles		BJS32-3	1SNA205775R1600	5	105.80
3 Splitters For 6.35x0.8mm faston clips and screws		DRF8	1SNA205768R2700	10	5.00
4 Protecting covers IP20 rotating protecting cover	Grey <input type="checkbox"/>	CPUF70	1SNA190017R1700	2	12.00
5 Terminal block markers Blank card	White <input type="checkbox"/>	RC810	1SNA234000R0200	1	8.20

Complete list of accessories is indicated in the terminal block datasheet. Some accessories such as jumper bars may modify the terminal block's ratings: complete information in the accessories catalogue pages.

Technical data valid for copper conductors only.

D120/42.FF power terminal blocks

Feed-through - 42 mm 1.653 in spacing

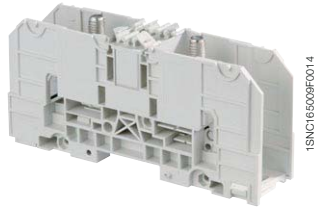

D120/42.FF

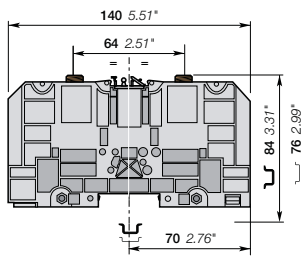

42 mm 1.653 in spacing

Description

- Rated cross section up to 300 mm² / 1000 Kcmil, IP20 protection cover,
- Holding foot on DIN 3 rail with two position for easy mounting, lug mounting in accordance with NF C 20-130 and DIN 46234, various marking options, rail or base mounting.

Ordering details

Description	Color	Type	Part Number	Pkg qty	Weight (1 pce) g
Feed-through 2 studs M10 without cover	Grey <input type="checkbox"/>	D120/42.FF	1SNA190003R2200	1	423.00

Main technical data

Connecting capacity		NF C	DIN	UL	CSA
Lugs	Rigid: Solid/Stranded	6-150 mm ²	6-120 mm ²	300 Kcmil	
	Flexible with insulated ferrule	6-120 mm ²			
	Gauge	C8			
Screw clamp		IEC	UL	CSA	
Screw clamp	Rigid: Solid/Stranded				
	Flexible without ferrule				
	Gauge				
Bar		IEC	UL	CSA	
Rated current		269 A		269 A	
Rated cross section		120 mm ²		300 Kcmil	
Rated voltage		1000 V		600 V	
Impulse withstand voltage		8000 V			

Mounting instructions

Rail		TH 35-7.5, TH 35-15
Lugs		Wrench H17 mm
Tool		
Torque		10 - 20 N.m 87 - 174 lb.in
Jumper screw		Allen key 6 mm 0.236 in
Tool		
Torque		6 - 12 N.m 52 - 104 lb.in
Screw clamp		
Tool		
Torque		
Wire stripping length		

The connecting capacity data for one Rigid: Solid/Stranded, or one Flexible conductor (when applicable) is a mandatory information required by IEC, UL and CSA standards (Copper conductors). All other data are provided as supplementary information only. For more details, please consult our CB, UL or CSA certificates and technical datasheet available on <http://www.TE.com>

RoHS <input type="checkbox"/>	UL <input type="checkbox"/>	CSA <input type="checkbox"/>	RoHS <input type="checkbox"/>	UL <input type="checkbox"/>	CSA <input type="checkbox"/>	RoHS <input type="checkbox"/>	UL <input type="checkbox"/>	CSA <input type="checkbox"/>
-------------------------------	-----------------------------	------------------------------	-------------------------------	-----------------------------	------------------------------	-------------------------------	-----------------------------	------------------------------

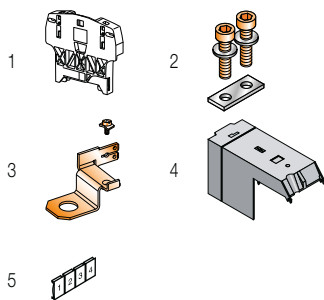

Accessories

Description	Color	Type	Part Number	Pkg qty	Weight (1 pce) g
1 End stops 10 mm 0.394 in	Dark grey <input type="checkbox"/>	BAZH1	1SNK900102R0000	20	24.00
2 Jumper bars 2 poles		BJS42-2	1SNA205776R1700	5	93.00
		BJS42-3	1SNA205777R1000	5	153.00
3 Splitters For 6.35x0.8mm faston clips and screws		DRF10	1SNA205769R2000	10	7.00
4 Protecting covers IP20 rotating protecting cover	Grey <input type="checkbox"/>	CPUF120	1SNA190018R2000	2	24.00
5 Terminal block markers Blank card	White <input type="checkbox"/>	RC810	1SNA234000R0200	1	8.20

Complete list of accessories is indicated in the terminal block datasheet.

Some accessories such as jumper bars may modify the terminal block's ratings: complete information in the accessories catalogue pages.

Technical data valid for copper conductors only.

D185/55.FF power terminal blocks

Feed-through - 55 mm 2.165 in spacing

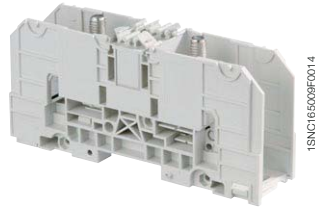

D185/55.FF

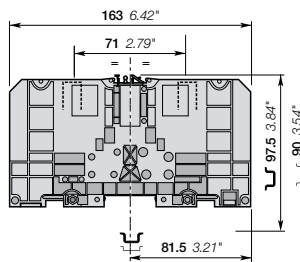

55 mm 2.165 in spacing

Description

- Rated cross section up to 300 mm² / 1000 Kcmil, IP20 protection cover,
- Holding foot on DIN 3 rail with two position for easy mounting, lug mounting in accordance with NF C 20-130 and DIN 46234, various marking options, rail or base mounting.

Ordering details

Description	Color	Type	Part Number	Pkg qty	Weight (1 pce) g
Feed-through 2 studs M12 without cover	Grey <input type="checkbox"/>	D185/55.FF	1SNA190004R2300	1	615.00

Main technical data

Connecting capacity	NF C	DIN	UL	CSA
Lugs	Rigid: Solid/Stranded 25-240 mm ² Flexible with insulated ferrule 6-185 mm ² Gauge C11	6-185 mm ²	500 Kcmil	
Screw clamp	Rigid: Solid/Stranded Flexible without ferrule Gauge			
Bar				
Rated current	353 A		353 A	
Rated cross section	185 mm ²		500 Kcmil	
Rated voltage	1000 V		600 V	
Impulse withstand voltage	8000 V			

Mounting instructions

Rail		TH 35-7.5, TH 35-15
Lugs		Wrench H24 mm
Tool		
Torque		14 - 30 N.m 123.9 - 265.5 lb.in
Jumper screw		Allen key 6 mm 0.236 in
Tool		
Torque		6 - 12 N.m 52 - 104 lb.in
Screw clamp		
Tool		
Torque		
Wire stripping length		

The connecting capacity data for one Rigid: Solid/Stranded, or one Flexible conductor (when applicable) is a mandatory information required by IEC, UL and CSA standards (Copper conductors). All other data are provided as supplementary information only. For more details, please consult our CB, UL or CSA certificates and technical datasheet available on <http://www.TE.com>

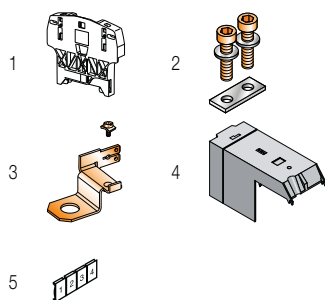

Accessories

Description	Color	Type	Part Number	Pkg qty	Weight (1 pce) g
1 End stops 10 mm 0.394 in	Dark grey <input checked="" type="checkbox"/>	BAZH1	1SNC900102R0000	20	24.00
2 Jumper bars 2 poles		BJS551-2	1SNA205778R2100	5	158.00
3 poles		BJS551-3	1SNA205779R2200	5	266.00
3 Splitters For 6.35x0.8mm faston clips and screws		DRF12	1SNA205770R2500	10	8.00
4 Protecting covers IP20 rotating protecting cover	Grey <input type="checkbox"/>	CPUF185	1SNA190019R2100	2	40.00
5 Terminal block markers Blank card	White <input type="checkbox"/>	RC810	1SNA234000R0200	1	8.20

Complete list of accessories is indicated in the terminal block datasheet.

Some accessories such as jumper bars may modify the terminal block's ratings: complete information in the accessories catalogue pages.

Technical data valid for copper conductors only.

D300/55.FF power terminal blocks

Feed-through - 55 mm 2.165 in spacing

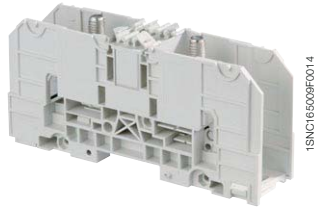

D300/55.FF

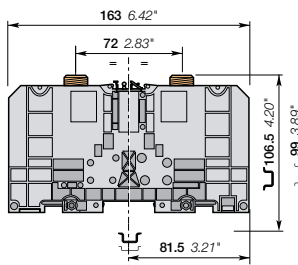

55 mm 2.165 in spacing

Description

- Rated cross section up to 300 mm² / 1000 Kcmil, IP20 protection cover,
- Holding foot on DIN 3 rail with two position for easy mounting, lug mounting in accordance with NF C 20-130 and DIN 46234, various marking options, rail or base mounting.

Ordering details

Description	Color	Type	Part Number	Pkg qty	Weight (1 pce) g
Feed-through 2 studs M16 without cover	Grey <input type="checkbox"/>	D300/55.FF	1SNA190005R2400	1	775.00

Main technical data

Connecting capacity		NF C	DIN	UL	CSA
Lugs	Rigid: Solid/Stranded	25-300 mm ²	6-300 mm ²	1000 Kcmil	
	Flexible with insulated ferrule	6-300 mm ²			
Gauge					
Screw clamp		IEC	UL	CSA	
Screw clamp	Rigid: Solid/Stranded				
	Flexible without ferrule				
Gauge					
Bar		IEC	UL	CSA	
Rated current		520 A	460 A		
Rated cross section		300 mm ²	1000 Kcmil		
Rated voltage		1000 V	600 V		
Impulse withstand voltage		8000 V			

Mounting instructions

Rail		TH 35-7.5, TH 35-15
Lugs		Wrench H24 mm
Tool		
Torque		25 - 50 N.m 217 - 435 lb.in
Jumper screw		Allen key 6 mm 0.236 in
Tool		
Torque		6 - 12 N.m 52 - 104 lb.in
Screw clamp		
Tool		
Torque		
Wire stripping length		

The connecting capacity data for one Rigid: Solid/Stranded, or one Flexible conductor (when applicable) is a mandatory information required by IEC, UL and CSA standards (Copper conductors). All other data are provided as supplementary information only. For more details, please consult our CB, UL or CSA certificates and technical datasheet available on <http://www.TE.com>

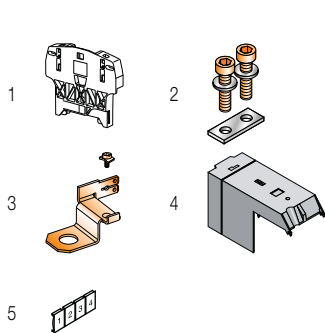

Accessories

Description	Color	Type	Part Number	Pkg qty	Weight (1 pce) g
1 End stops 10 mm 0.394 in	Dark grey <input type="checkbox"/>	BAZH1	1SNK900102R0000	20	24.00
2 Jumper bars 2 poles		BJS551-2	1SNA205778R2100	5	158.00
		BJS551-3	1SNA205779R2200	5	266.00
3 Splitters For 6.35x0.8mm faston clips and screws		DRF16	1SNA205771R1200	10	7.00
4 Protecting covers IP20 rotating protecting cover	Grey <input type="checkbox"/>	CPUF185	1SNA190019R2100	2	40.00
5 Terminal block markers Blank card	White <input type="checkbox"/>	RC810	1SNA234000R0200	1	8.20

Complete list of accessories is indicated in the terminal block datasheet.

Some accessories such as jumper bars may modify the terminal block's ratings: complete information in the accessories catalogue pages.

Technical data valid for copper conductors only.

D35/27.AF power terminal blocks

Feed-through - 27 mm 1.062 in spacing

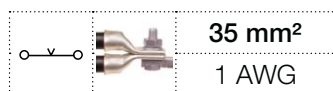

D35/27.AF

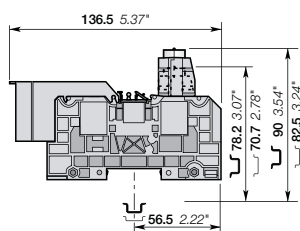

27 mm 1.062 in spacing

Description

- Rated cross section up to 240 mm² / 500 Kcmil, IP20 protection cover,
- Holding foot on DIN 3 rail with two position for easy mounting, lug mounting in accordance with NF C 20-130 and DIN 46234, various marking options, rail or base mounting.

Ordering details

Description	Color	Type	Part Numbers	Pkg qty	Weight (1 pce)
Feed-through 1 stud M6 + 1 screw clamp with covers	Grey <input type="checkbox"/>	D35/27.AF	1SNA190006R2500	10	149.00 g

Main technical data

Connecting capacity	NFC	DIN	UL	CSA
Lugs				
Rigid: Solid/Stranded	2.5-35 mm ²	2.5-50 mm ²	1 AWG	
Flexible with insulated ferrule	2.5-35 mm ²	2.5-35 mm ²		
Gauge	C4			
Screw clamp				
Rigid: Solid/Stranded	2.5-35 mm ²		1-12 AWG	
Flexible without ferrule	2.5-35 mm ²			
Gauge				
Bar				
Rated current	125 A		130 A	
Rated cross section	35 mm ²		1 AWG	
Rated voltage	1000 V		600 V	
Impulse withstand voltage	8000 V			

Mounting instructions

Rail		TH 35-7.5, TH 35-15
Lugs		Wrench H10 mm
Tool		
Torque		3 - 6 N.m 26.1 - 52 lb.in
Jumper screw		Allen key 6 mm 0.236 in
Tool		
Torque		6 - 12 N.m 52 - 104 lb.in
Screw clamp		Allen key 5 mm 0.197 in
Tool		
Torque		3.5 ± 0.5 N.m 30.9 ± 4.43 lb.in
Wire stripping length		28 mm 1.102 in

The connecting capacity data for one Rigid: Solid/Stranded, or one Flexible conductor (when applicable) is a mandatory information required by IEC, UL and CSA standards (Copper conductors). All other data are provided as supplementary information only. For more details, please consult our CB, UL or CSA certificates and technical datasheet available on <http://www.TE.com>

RoHS	UL	Gost R

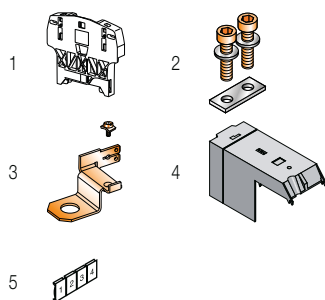

Accessories

Description	Color	Type	Part Numbers	Pkg qty	Weight (1 pce)
1 End stops 10 mm 0.394 in	Dark grey <input checked="" type="checkbox"/>	BAZH1	1SNK900102R0000	20	24.00
2 Jumper bars 2 poles		BJS27-2	1SNA205772R1300	5	34.00
3 poles		BJS27-3	1SNA205773R1400	5	52.00
3 Splitters For 6.35x0.8mm faston clips and screws		DRF6	1SNA205767R1600	10	4.00
4 Protecting covers IP20 rotating protecting cover	Grey <input type="checkbox"/>	CPUF35	1SNA190016R1600	2	8.30
5 Terminal block markers Blank card	White <input type="checkbox"/>	RC810	1SNA234000R0200	1	8.20

Complete list of accessories is indicated in the terminal block datasheet. Some accessories such as jumper bars may modify the terminal block's ratings: complete information in the accessories catalogue pages.

Technical data valid for copper conductors only.

D70/32.AF power terminal blocks

Feed-through - 32 mm 1.260 in spacing

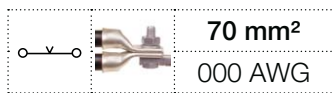

D70/32.AF

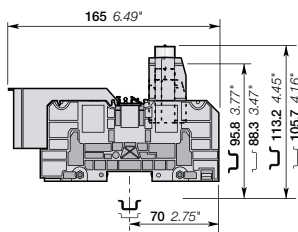

32 mm 1.260 in spacing

Description

- Rated cross section up to 240 mm² / 500 Kcmil, IP20 protection cover,
- Holding foot on DIN 3 rail with two position for easy mounting, lug mounting in accordance with NF C 20-130 and DIN 46234, various marking options, rail or base mounting.

Ordering details

Description	Color	Type	Part Numbers	Pkg qty	Weight (1 pce)
Feed-through 1 stud M8 + 1 screw clamp with covers	Grey <input type="checkbox"/>	D70/32.AF	1SNA190007R2600	3	269.00

Main technical data

Connecting capacity		NFC	DIN	UL	CSA
Lugs	Rigid: Solid/Stranded	6-95 mm ²	6-70 mm ²	000 AWG	
	Flexible with insulated ferrule	6-70 mm ²	6-70 mm ²		
	Gauge				
Screw clamp	Rigid: Solid/Stranded	6-95 mm ²		10-000 AWG	
	Flexible without ferrule	6-70 mm ²			
	Gauge				
Bar					
	Rated current		192 A	165 A	
	Rated cross section		70 mm ²	000 AWG	
Rated voltage		1000 V	600 V		
Impulse withstand voltage		8000 V			

Mounting instructions

Rail		TH 35-7.5, TH 35-15
Lugs		Wrench
Tool		H13 mm
Torque		6 - 12 N.m 52 - 104 lb.in
Jumper screw		Allen key
Tool		6 mm 0.236 in
Torque		6 - 12 N.m 52 - 104 lb.in
Screw clamp		Wrench
Tool		6 mm 0.236 in
Torque		7 ±1 N.m 61.9 ± 8.85 lb.in
Wire stripping length		33 mm 1.299 in

The connecting capacity data for one Rigid: Solid/Stranded, or one Flexible conductor (when applicable) is a mandatory information required by IEC, UL and CSA standards (Copper conductors). All other data are provided as supplementary information only. For more details, please consult our CB, UL or CSA certificates and technical datasheet available on <http://www.TE.com>

RoHS <input type="checkbox"/>	RoHS <input type="checkbox"/>	UL <input type="checkbox"/>	UL <input type="checkbox"/>	UL <input type="checkbox"/>	UL <input type="checkbox"/>	UL <input type="checkbox"/>	UL <input type="checkbox"/>	UL <input type="checkbox"/>	UL <input type="checkbox"/>	UL <input type="checkbox"/>	UL <input type="checkbox"/>	UL <input type="checkbox"/>	UL <input type="checkbox"/>
-------------------------------	-------------------------------	-----------------------------	-----------------------------	-----------------------------	-----------------------------	-----------------------------	-----------------------------	-----------------------------	-----------------------------	-----------------------------	-----------------------------	-----------------------------	-----------------------------

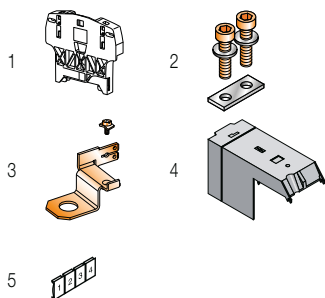

Accessories

Description	Color	Type	Part Numbers	Pkg qty	Weight (1 pce)
1 End stops 10 mm 0.394 in	Dark grey <input type="checkbox"/>	BAZH1	1SNK900102R000	20	24.00
2 Jumper bars		BJS32-2	1SNA205774R1500	5	66.00
		BJS32-3	1SNA205775R1600	5	105.80
3 Splitters For 6.35x0.8mm faston clips and screws		DRF8	1SNA205768R2700	10	5.00
4 Protecting covers IP20 rotating protecting cover	Grey <input type="checkbox"/>	CPUF70	1SNA190017R1700	2	12.00
5 Terminal block markers Blank card	White <input type="checkbox"/>	RC810	1SNA234000R0200	1	8.20

Complete list of accessories is indicated in the terminal block datasheet.
Some accessories such as jumper bars may modify the terminal block's ratings: complete information in the accessories catalogue pages.

Technical data valid for copper conductors only.

D120/42.AF power terminal blocks

Feed-through - 42 mm 1.653 in spacing

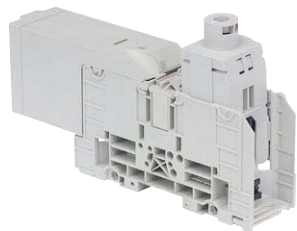

D120/42.AF

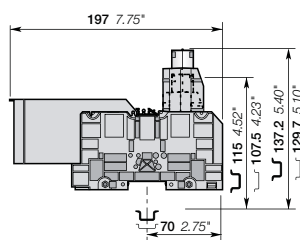

42 mm 1.653 in spacing

Description

- Rated cross section up to 240 mm² / 500 Kcmil, IP20 protection cover,
- Holding foot on DIN 3 rail with two position for easy mounting, lug mounting in accordance with NF C 20-130 and DIN 46234, various marking options, rail or base mounting.

Ordering details

Description	Color	Type	Part Numbers	Pkg qty	Weight (1 pce)
Feed-through 1 stud M10 + 1 screw clamp with covers	Grey <input type="checkbox"/>	D120/42.AF	1SNA190008R0700	1	423.00 g

Main technical data

Connecting capacity	NFC	DIN	UL	CSA
Lugs				
Rigid: Solid/Stranded	6-150 mm ²	6-120 mm ²	300 Kcmil	
Flexible with insulated ferrule	6-120 mm ²			
Gauge	C8			
Screw clamp				
Rigid: Solid/Stranded	6-150 mm ²		10 AWG-300 Kcmil	
Flexible without ferrule	6-120 mm ²			
Gauge				
Bar				
Rated current	269 A		240 A	
Rated cross section	120 mm ²		300 Kcmil	
Rated voltage	1000 V		600 V	
Impulse withstand voltage	8000 V			

Mounting instructions

Rail		TH 35-7.5, TH 35-15
Lugs		Wrench H17 mm
Tool		
Torque		10 - 20 N.m 87 - 174 lb.in
Jumper screw		Allen key 6 mm 0.236 in
Tool		
Torque		6 - 12 N.m 52 - 104 lb.in
Screw clamp		Allen key 8 mm 0.315 in
Tool		
Torque		11 ± 1 N.m 97.36 ± 8.85 lb.in
Wire stripping length		38 mm 1.496 in

The connecting capacity data for one Rigid: Solid/Stranded, or one Flexible conductor (when applicable) is a mandatory information required by IEC, UL and CSA standards (Copper conductors). All other data are provided as supplementary information only. For more details, please consult our CB, UL or CSA certificates and technical datasheet available on <http://www.TE.com>

RoHS	UL	Gost R

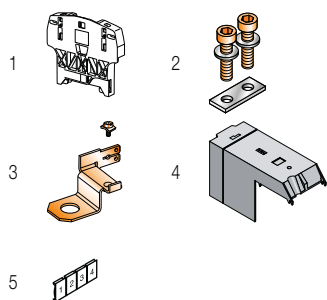

Accessories

Description	Color	Type	Part Numbers	Pkg qty	Weight (1 pce)
1 End stops 10 mm 0.394 in	Dark grey <input checked="" type="checkbox"/>	BAZH1	1SNK900102R0000	20	24.00
2 Jumper bars 2 poles		BJS42-2	1SNA205776R1700	5	93.00
3 poles		BJS42-3	1SNA205777R1000	5	153.00
3 Splitters For 6.35x0.8mm faston clips and screws		DRF10	1SNA205769R2000	10	7.00
4 Protecting covers IP20 rotating protecting cover	Grey <input type="checkbox"/>	CPUF120	1SNA190018R2000	2	24.00
5 Terminal block markers Blank card	White <input type="checkbox"/>	RC810	1SNA234000R0200	1	8.20

Complete list of accessories is indicated in the terminal block datasheet. Some accessories such as jumper bars may modify the terminal block's ratings: complete information in the accessories catalogue pages.

Technical data valid for copper conductors only.

D185/55.AF power terminal blocks

Feed-through - 55 mm 2.165 in spacing



D185/55.AF

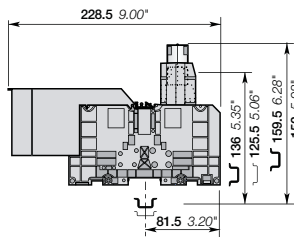

55 mm 2.165 in spacing

Description

- Rated cross section up to 240 mm² / 500 Kcmil, IP20 protection cover,
- Holding foot on DIN 3 rail with two position for easy mounting, lug mounting in accordance with NF C 20-130 and DIN 46234, various marking options, rail or base mounting.

Ordering details

Description	Color	Type	Part Numbers	Pkg qty	Weight (1 pce) g
Feed-through 1 stud M12 + 1 screw clamp with covers	Grey <input type="checkbox"/>	D185/55.AF	1SNA190009R0000	1	937.00

Main technical data

Connecting capacity		NFC	DIN	UL	CSA
Lugs	Rigid: Solid/Stranded	25-240 mm ²	6-185 mm ²	500 Kcmil	
	Flexible with insulated ferrule	6-185 mm ²			
	Gauge	C11			
Screw clamp		IEC		UL	CSA
	Rigid: Solid/Stranded	25-240 mm ²		4 AWG-500 Kcmil	
	Flexible without ferrule	25-185 mm ²			
Gauge					
Bar		IEC		UL	CSA
Rated current		353 A		320 A	
Rated cross section		185 mm ²		500 Kcmil	
Rated voltage		1000 V		600 V	
Impulse withstand voltage		8000 V			

Mounting instructions

Rail		TH 35-7.5, TH 35-15
Lugs		Wrench H24 mm
Tool		
Torque		14 - 30 N.m 123.9 - 265.5 lb.in
Jumper screw		Allen key 6 mm 0.236 in
Tool		
Torque		6 - 12 N.m 53.1 - 106.2 lb.in
Screw clamp		Allen key 10 mm 0.394 in
Tool		
Torque		15 ± 1 N.m 132.7 ± 8.85 lb.in
Wire stripping length		47 mm 1.850 in

The connecting capacity data for one Rigid: Solid/Stranded, or one Flexible conductor (when applicable) is a mandatory information required by IEC, UL and CSA standards (Copper conductors). All other data are provided as supplementary information only. For more details, please consult our CB, UL or CSA certificates and technical datasheet available on <http://www.TE.com>

RoHS:	UL:	CSA:	RoHS:	USR CNR:	PC:	Gost R:
-------	-----	------	-------	----------	-----	---------

Accessories

Description	Color	Type	Part Numbers	Pkg qty	Weight (1 pce) g
1 End stops 10 mm 0.394 in	Dark grey <input type="checkbox"/>	BAZH1	1SNK900102R0000	20	24.00
2 Jumper bars 2 poles		BJS551-2	1SNA205778R2100	5	158.00
		BJS551-3	1SNA205779R2200	5	266.00
3 Splitters For 6.35x0.8mm faston clips and screws		DRF12	1SNA205770R2500	10	8.00
4 Protecting covers IP20 rotating protecting cover	Grey <input type="checkbox"/>	CPUF185	1SNA190019R2100	2	40.00
5 Terminal block markers Blank card	White <input type="checkbox"/>	RC810	1SNA234000R0200	1	8.20

Complete list of accessories is indicated in the terminal block datasheet.

Some accessories such as jumper bars may modify the terminal block's ratings: complete information in the accessories catalogue pages.

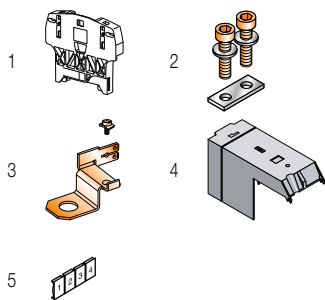

Technical data valid for copper conductors only.

Power terminal blocks

Mounting instructions

Main dimensions mm

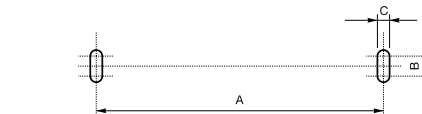
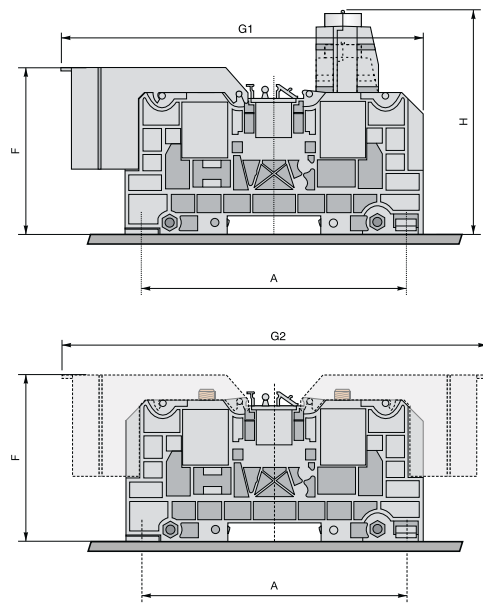

D 35/27.AF - D 70/32.AF - D 120/42.AF
D 35/27.FF - D 70/32.FF - D 120/42.FF

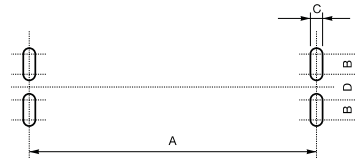

D 185/55.AF
D 185/55.FF - D 300/55.FF

Type	Mounting with:	A	B	C	D	F	G1	G2	H
		Dimensions mm							
D35/27...	2 Screws	100.5	7.5	6.5	/	63.5	136.5	160	82.5
D70/32...	2 Screws	120	7.5	6.5	/	72.5	165	190.5	105.7
D120/42...	2 Screws	120	7.5	6.5	/	83.5	197	255.5	129.7
D185/55...	4 Screws	135	13.5	6.5	8.5	103.5	228.5	295	151.5
D300/55...	4 Screws	135	13.5	6.5	8.5	105	/	295	/

Marking

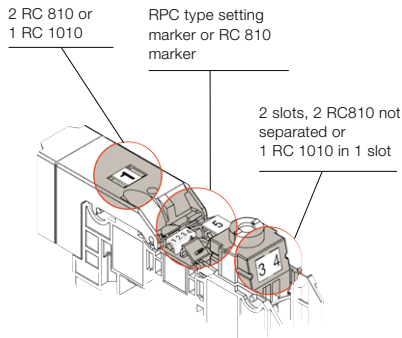

Jumper bar

- move the marker holders up
- cut out the partition
- screw the jumper bar

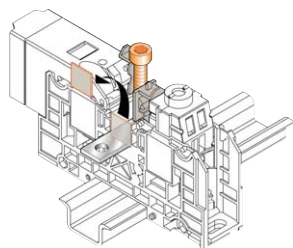

Locking foot operating with screwdriver DIA. 4 mm

Center opening (to be made after jumper bar has been removed) "monostable action".

As soon as the screwdriver is removed, the locking foot comes back to closed position

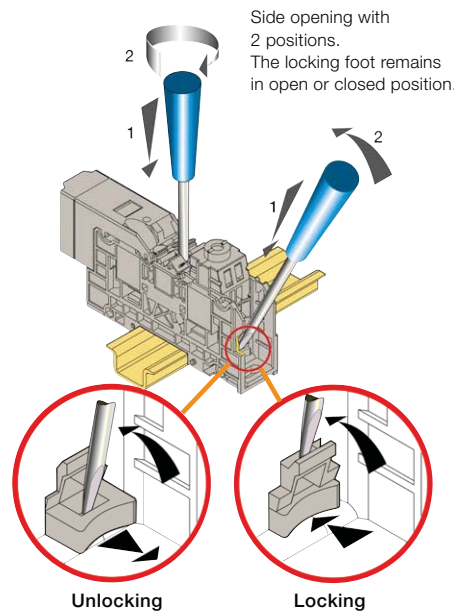

Locking

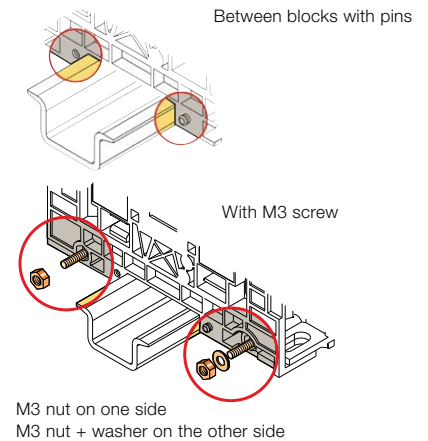

Mounting of the derivative system

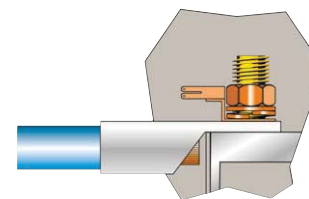

M35/26.FF stud terminal blocks

Feed-through - 26 mm 1.024 in spacing



M35/26.FF

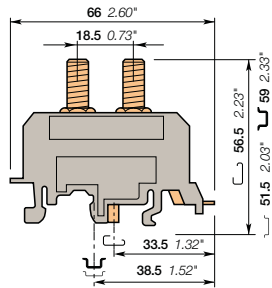

26 mm 1.024 in spacing

Description

- Compact two stud terminal block,
- Lug mounting in accordance with NF C 20-130 and DIN 46234,
- Various marking options,
- Rail or base mounting.

Ordering details

Description	Color	Type	Part Number	Pkg pce	Weight (1 pce) g
Feed-through 2 studs M6 linked by 1 removable bar 16 x 4 mm	Grey <input type="checkbox"/>	M35/26.FF	1SNA115140R2300	10	64.00

Main technical data

Lugs	Rigid: Solid/Stranded Flexible with insulated ferrule Gauge	NFC	DIN	UL	CSA
		4-35 mm ²	2.5-50 mm ²	10-2 AWG	max 4 AWG
Screw clamp	Rigid: Solid/Stranded Flexible without ferrule Gauge	IEC	DIN	UL	CSA
		16 x 4 mm	0.63 x 0.16 in		
Bar		16 x 4 mm	0.63 x 0.16 in		
Rated current		101 A	125 A	115 A	125 A
Rated cross section		25 mm ²	35 mm ²	2 AWG	4 AWG
Rated voltage		1000 V		600 V	600 V
Impulse withstand voltage		8000 V			

Mounting instructions

Rail		G32, TH 35-7.5, TH 35-15
Lugs		Wrench
Tool		H10 mm
Torque		4.5-9 N.m 39.8-79.6 lb.in
Jumper screw		
Tool		
Torque		
Screw clamp		
Tool		
Torque		
Wire stripping length		

The connecting capacity data for one Rigid: Solid/Stranded, or one Flexible conductor (when applicable) is a mandatory information required by IEC, UL and CSA standards (Copper conductors). All other data are provided as supplementary information only. For more details, please consult our CB, UL or CSA certificates and technical datasheet available on <http://www.TE.com>



Accessories

Description	Color	Type	Part Number	Pkg pce	Weight (1 pce) g
1 End stops	Grey <input type="checkbox"/>	BAMH	1SNA114836R0000	50	13.00
	Dark grey <input type="checkbox"/>	BAZH1	1SNK900102R0000	20	24.00
2 Circuit separators	Grey <input type="checkbox"/>	ECP26	1SNA113689R2400	10	6.40
3 Protecting covers	Transparent <input checked="" type="checkbox"/>	CPP261	1SNA168202R1300	5	5.00
		CPP262	1SNA168201R1200	5	10.00
		CPP263	1SNA163403R2000	5	17.00
4 Terminal block markers	Grey <input type="checkbox"/>	PEP	1SNA113762R2400	50	0.46
	White <input type="checkbox"/>	RC610	1SNA233000R0100	1	7.50

Complete list of accessories is indicated in the terminal block datasheet.

Some accessories such as jumper bars may modify the terminal block's ratings: complete information in the accessories catalogue pages.

Technical data valid for copper conductors only.

M70/31.FF stud terminal blocks

Feed-through - 31 mm 1.220 in spacing

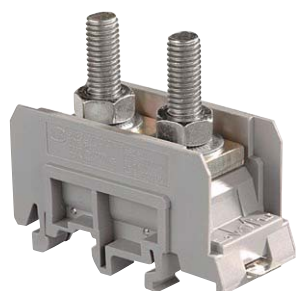
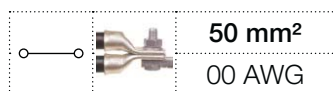

M70/31.FF

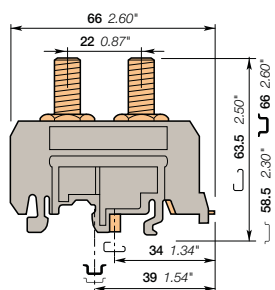

31 mm 1.220 in spacing

Description

- Compact two stud terminal block,
- Lug mounting in accordance with NF C 20-130 and DIN 46234,
- Various marking options,
- Rail or base mounting.

Ordering details

Description	Color	Type	Part Number	Pkg pce	Weight (1 pce) g
Feed-through 2 studs M8 linked by 1 removable bar 20 x 5 mm	Grey <input type="checkbox"/>	M70/31.FF	1SNA115143R1200	10	110.00

Main technical data

		NFC	DIN	UL	CSA
Lugs	Rigid: Solid/Stranded	6-70 mm ²	2.5-70 mm ²	4-00 AWG	max 0 AWG
	Flexible with insulated ferrule	6-50 mm ²	2.5-50 mm ²		
	Gauge	C5			
		IEC	DIN	UL	CSA
Screw clamp	Rigid: Solid/Stranded				
	Flexible without ferrule				
		IEC	DIN	UL	CSA
Bar		20 x 5 mm	0.78 x 0.20 in		
Rated current		150 A	178 A	175 A	200 A
Rated cross section		50 mm ²	50 mm ²	00 AWG	0 AWG
Rated voltage		1000 V		600 V	600 V
Impulse withstand voltage		8000 V			

Mounting instructions

Rail		G32, TH 35-7.5, TH 35-15
Lugs		Wrench
Tool		H13 mm
Torque		6-12 N.m 53.1-106.2 lb.in
Jumper screw		
Tool		
Torque		
Screw clamp		
Tool		
Torque		
Wire stripping length		

The connecting capacity data for one Rigid: Solid/Stranded, or one Flexible conductor (when applicable) is a mandatory information required by IEC, UL and CSA standards (Copper conductors). All other data are provided as supplementary information only. For more details, please consult our CB, UL or CSA certificates and technical datasheet available on <http://www.TE.com>

RoHS	UL	CSA	Gost R

Accessories

Description	Color	Type	Part Number	Pkg pce	Weight (1 pce) g
1 End stops	Grey <input type="checkbox"/>	BAMH	1SNA114836R0000	50	13.00
	Dark grey <input type="checkbox"/>	BAZH1	1SNK900102R0000	20	24.00
2 Circuit separators	Grey <input type="checkbox"/>	ECP31	1SNA113690R2100	10	6.70
3 Protecting covers	Transparent <input checked="" type="checkbox"/>	CPP311	1SNA168204R1500	5	7.00
		CPP312	1SNA168203R1400	5	14.00
		CPP313	1SNA163409R0600	5	23.00
4 Terminal block markers	Grey <input type="checkbox"/>	PEP	1SNA113762R2400	50	0.46
	White <input type="checkbox"/>	RC610	1SNA233000R0100	1	7.50

Complete list of accessories is indicated in the terminal block datasheet.

Some accessories such as jumper bars may modify the terminal block's ratings: complete information in the accessories catalogue pages.

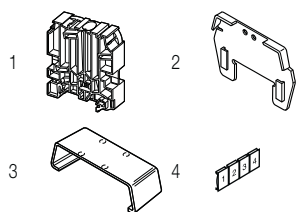

Technical data valid for copper conductors only.

M120/35.FF stud terminal blocks

Feed-through - 35 mm 1.380 in spacing

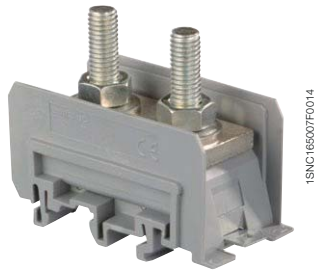
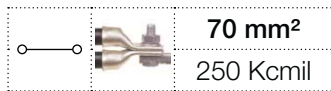

M120/35.FF

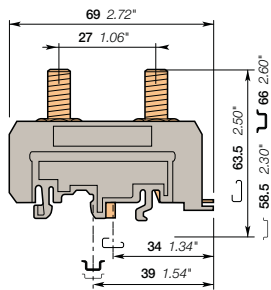

35 mm 1.380 in spacing

Description

- Compact two stud terminal block,
- Lug mounting in accordance with NF C 20-130 and DIN 46234,
- Various marking options,
- Rail or base mounting.

Ordering details

Description	Color	Type	Part Number	Pkg pce	Weight (1 pce) g
Feed-through 2 studs M8 linked by 1 removable bar 25 x 5 mm	Grey <input type="checkbox"/>	M120/35.FF	1SNA115146R1500	10	130.00

Main technical data

Lugs	Rigid: Solid/Stranded Flexible with insulated ferrule Gauge	NFC	DIN	UL	CSA
		6-95 mm ²	2.5-70 mm ²	2-250 kcmil	max 000 AWG
Screw clamp	Rigid: Solid/Stranded Flexible without ferrule Gauge	IEC	DIN	UL	CSA
Bar		IEC	DIN	UL	CSA
		25 x 5 mm	1 x 0.20 in		
Rated current		192 A	220 A	255 A	270 A
Rated cross section		70 mm ²	70 mm ²	250 Kcmil	000 AWG
Rated voltage		1000 V		600 V	600 V
Impulse withstand voltage		8000 V			

Mounting instructions

Rail		G32, TH 35-7.5, TH 35-15
Lugs Tool		Wrench H13 mm
Torque		6-12 N.m 53.1-106.2 lb.in
Jumper screw Tool		
Torque		
Screw clamp Tool		
Torque		
Wire stripping length		

The connecting capacity data for one Rigid: Solid/Stranded, or one Flexible conductor (when applicable) is a mandatory information required by IEC, UL and CSA standards (Copper conductors). All other data are provided as supplementary information only. For more details, please consult our CB, UL or CSA certificates and technical datasheet available on <http://www.TE.com>

RoHS <input type="checkbox"/>	USF <input type="checkbox"/>	CSA <input type="checkbox"/>	Gost R <input type="checkbox"/>
-------------------------------	------------------------------	------------------------------	---------------------------------

Accessories

Description	Color	Type	Part Number	Pkg pce	Weight (1 pce) g
1 End stops	Grey <input type="checkbox"/>	BAMH	1SNA114836R0000	50	13.00
	Dark grey <input type="checkbox"/>	BAZH1	1SNK900102R0000	20	24.00
2 Circuit separators	Grey <input type="checkbox"/>	ECP35	1SNA113691R1600	10	10.00
3 Protecting covers	Transparent <input checked="" type="checkbox"/>	CPP351	1SNA168206R1700	5	8.00
		CPP352	1SNA168205R1600	5	20.00
		CPP353	1SNA163418R2600	5	20.00
4 Terminal block markers	Grey <input type="checkbox"/>	PEP	1SNA113762R2400	50	0.46
	White <input type="checkbox"/>	RC610	1SNA233000R0100	1	7.50

Complete list of accessories is indicated in the terminal block datasheet.

Some accessories such as jumper bars may modify the terminal block's ratings: complete information in the accessories catalogue pages.

Technical data valid for copper conductors only.

M300/42.FF stud terminal blocks

Feed-through - 42 mm 1.653 in spacing

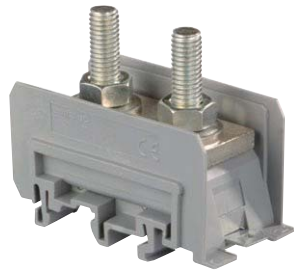

M300/42.FF

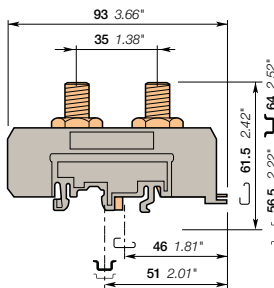

42 mm 1.653 in spacing

Description

- Compact two stud terminal block,
- Lug mounting in accordance with NF C 20-130 and DIN 46234,
- Various marking options,
- Rail or base mounting.

Ordering details

Description	Color	Type	Part Number	Pkg pce	Weight (1 pce) g
Feed-through 2 studs M10 linked by 1 removable bar 32 x 8 mm	Grey <input type="checkbox"/>	M300/42.FF	1SNA115149R2000	10	220.00

Main technical data

		NFC	DIN	UL	CSA
Lugs	Rigid: Solid/Stranded	50-150 mm ²	6-150 mm ²	0-500 kcmil	max 500 Kcmil
	Flexible with insulated ferrule	50-120 mm ²	6-120 mm ²		
Gauge		C8			
		IEC	DIN	UL	CSA
Screw clamp	Rigid: Solid/Stranded				
	Flexible without ferrule				
Gauge					
		IEC	DIN	UL	CSA
Bar		32 x 8 mm	1.26 x 0.32 in		
Rated current		269 A	265 A	230 A	550 A
Rated cross section		120 mm ²	120 mm ²	500 Kcmil	500 Kcmil
Rated voltage		1000 V		600 V	600 V
Impulse withstand voltage		8000 V			

Mounting instructions

Rail		G32, TH 35-7.5, TH 35-15
Lugs		Wrench
Tool		H16 mm
Torque		10-20 N.m 88.5-177 lb.in
Jumper screw		
Tool		
Torque		
Screw clamp		
Tool		
Torque		
Wire stripping length		

The connecting capacity data for one Rigid: Solid/Stranded, or one Flexible conductor (when applicable) is a mandatory information required by IEC, UL and CSA standards (Copper conductors). All other data are provided as supplementary information only. For more details, please consult our CB, UL or CSA certificates and technical datasheet available on <http://www.TE.com>



Accessories

Description	Color	Type	Part Number	Pkg pce	Weight (1 pce) g
1 End stops	Grey <input type="checkbox"/>	BAMH	1SNA114836R0000	50	13.00
	Dark grey <input type="checkbox"/>	BAZH1	1SNK900102R0000	20	24.00
2 Circuit separators	Grey <input type="checkbox"/>	ECP42	1SNA113692R1700	10	20.00
3 Protecting covers	Transparent <input checked="" type="checkbox"/>	CPP421	1SNA168208R2100	5	13.00
		CPP422	1SNA168207R1000	5	30.00
		CPP423	1SNA163424R1400	5	40.00
4 Terminal block markers	Grey <input type="checkbox"/>	PEP	1SNA113762R2400	50	0.46
	White <input type="checkbox"/>	RC610	1SNA233000R0100	1	7.50

Complete list of accessories is indicated in the terminal block datasheet.

Some accessories such as jumper bars may modify the terminal block's ratings: complete information in the accessories catalogue pages.

Technical data valid for copper conductors only.

M35/26.AF stud terminal blocks

Feed-through - 26 mm 1.024 in spacing

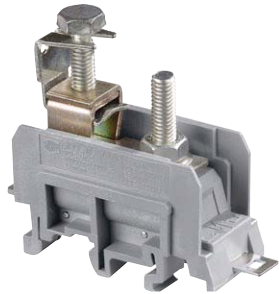
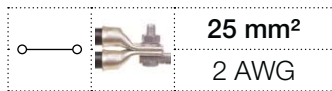

M35/26.AF

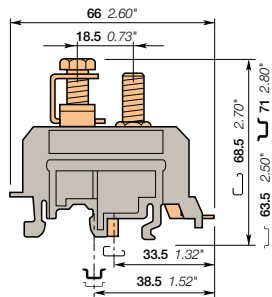

26 mm 1.024 in spacing

Description

- Compact one stud / one clamp terminal block,
- Lug mounting in accordance with NF C 20-130 and DIN 46234,
- Various marking options,
- Rail or base mounting.

Ordering details

Description	Color	Type	Part Number	Pkg pce	Weight (1 pce) g
Feed-through 1 stud M6 + 1 screw clamp	Grey <input type="checkbox"/>	M35/26.AF	1SNA115139R1600	10	60.00

Main technical data

Lugs	Rigid: Solid/Stranded Flexible with insulated ferrule Gauge	NFC	DIN	UL	CSA
		4-35 mm²	2.5-50 mm²	10-2 AWG	10-4 AWG
		4-25 mm²	2.5-25 mm²		
		C3			
Screw clamp	Rigid: Solid/Stranded Flexible without ferrule Gauge	IEC	DIN	UL	CSA
		6-50 mm²	6-50 mm²	14-2 AWG	10-4 AWG
		6-25 mm²			
Bar	Rated current	IEC	DIN	UL	CSA
		101 A	115 A	115 A	125 A
Rated cross section		25 mm²	25 mm²	2 AWG	4 AWG
Rated voltage		1000 V		600 V	600 V
Impulse withstand voltage		8000 V			

Mounting instructions

Rail		G32, TH 35-7.5, TH 35-15
Lugs		Wrench H10 mm
Tool		
Torque		4.5-9 N.m 39.8-79.6 lb.in
Jumper screw		
Tool		
Torque		
Screw clamp		Wrench H10 mm
Tool		
Torque		5 ± 0.5 N.m 44.25 ± 4.43 lb.in
Wire stripping length		19 mm 0.748 in

The connecting capacity data for one Rigid: Solid/Stranded, or one Flexible conductor (when applicable) is a mandatory information required by IEC, UL and CSA standards (Copper conductors). All other data are provided as supplementary information only. For more details, please consult our CB, UL or CSA certificates and technical datasheet available on <http://www.TE.com>

RoHS <input type="checkbox"/>	RoHS	USR <input type="checkbox"/>	USR	CSA <input type="checkbox"/>	CSA	Gost R <input type="checkbox"/>	Gost R
-------------------------------	------	------------------------------	-----	------------------------------	-----	---------------------------------	--------

Accessories

Description	Color	Type	Part Number	Pkg pce	Weight (1 pce) g
1 End stops	Grey <input type="checkbox"/>	BAMH	1SNA114836R0000	50	13.00
	Dark grey <input type="checkbox"/>	BAZH1	1SNK900102R0000	20	24.00
2 Circuit separators	Grey <input type="checkbox"/>	ECP26	1SNA113689R2400	10	6.40
3 Protecting covers	Transparent <input checked="" type="checkbox"/>	CPP261	1SNA168202R1300	5	5.00
		CPP262	1SNA168201R1200	5	10.00
		CPP263	1SNA163403R2000	5	17.00
4 Terminal block markers	Grey <input type="checkbox"/>	PEP	1SNA113762R2400	50	0.46
	White <input type="checkbox"/>	RC610	1SNA233000R0100	1	7.50

Complete list of accessories is indicated in the terminal block datasheet.

Some accessories such as jumper bars may modify the terminal block's ratings: complete information in the accessories catalogue pages.

Technical data valid for copper conductors only.

M70/31.AF stud terminal blocks

Feed-through - 31 mm 1.220 in spacing

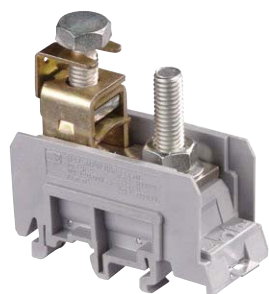

M70/31.AF

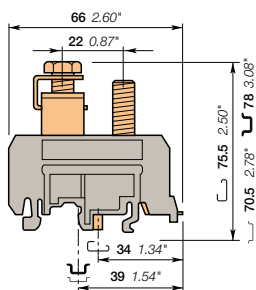

31 mm 1.220 in spacing

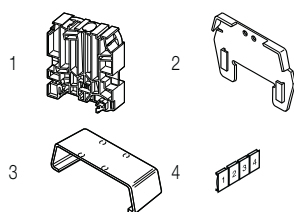

Description

- Compact one stud / one clamp terminal block,
- Lug mounting in accordance with NF C 20-130 and DIN 46234,
- Various marking options,
- Rail or base mounting.

Ordering details

Description	Color	Type	Part Number	Pkg pce	Weight (1 pce) g
Feed-through 1 stud M8 + 1 screw clamp	Grey <input type="checkbox"/>	M70/31.AF	1SNA115142R1100	10	110.00

Main technical data

Lugs	Rigid: Solid/Stranded Flexible with insulated ferrule Gauge	NFC	DIN	UL	CSA
		6-70 mm ²	2.5-70 mm ²	8-0 AWG	6-0 AWG
		C5			
Screw clamp	Rigid: Solid/Stranded Flexible without ferrule Gauge	IEC	DIN	UL	CSA
		6-70 mm ²	6-70 mm ²	8-0 AWG	6-0 AWG
		6-50 mm ²			
Bar		IEC	DIN	UL	CSA
Rated current		150 A	178 A	150 A	200 A
Rated cross section		50 mm ²	50 mm ²	0 AWG	0 AWG
Rated voltage		1000 V		600 V	600 V
Impulse withstand voltage		8000 V			

Mounting instructions

Rail		G32, TH 35-7.5, TH 35-15
Lugs		Wrench H13 mm
Tool		
Torque		6-12 N.m 53.1-106.2 lb.in
Jumper screw		
Tool		
Torque		
Screw clamp		Wrench H13 mm
Tool		
Torque		7 ± 1 N.m 61.9 ± 8.85 lb.in
Wire stripping length		22 mm 0.866 in

The connecting capacity data for one Rigid: Solid/Stranded, or one Flexible conductor (when applicable) is a mandatory information required by IEC, UL and CSA standards (Copper conductors). All other data are provided as supplementary information only. For more details, please consult our CB, UL or CSA certificates and technical datasheet available on <http://www.TE.com>

--	--	--	--	--

Accessories

Description	Color	Type	Part Number	Pkg pce	Weight (1 pce) g
1 End stops	Grey <input type="checkbox"/>	BAMH	1SNA114836R0000	50	13.00
	Dark grey <input type="checkbox"/>	BAZH1	1SNK900102R0000	20	24.00
2 Circuit separators	Grey <input type="checkbox"/>	ECP31	1SNA113690R2100	10	6.70
3 Protecting covers	Transparent <input checked="" type="checkbox"/>	CPP311	1SNA168204R1500	5	7.00
		CPP312	1SNA168203R1400	5	14.00
		CPP313	1SNA163409R0600	5	23.00
4 Terminal block markers	Grey <input type="checkbox"/>	PEP	1SNA113762R2400	50	0.46
	White <input type="checkbox"/>	RC610	1SNA233000R0100	1	7.50

Complete list of accessories is indicated in the terminal block datasheet. Some accessories such as jumper bars may modify the terminal block's ratings: complete information in the accessories catalogue pages.

Technical data valid for copper conductors only.

M120/35.AF stud terminal blocks

Feed-through - 35 mm 1.380 in spacing

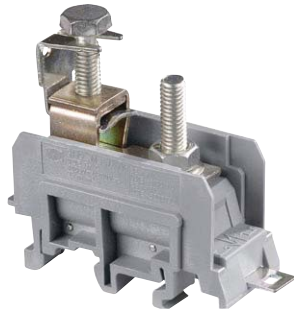
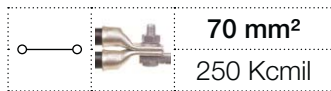

M120/35.AF

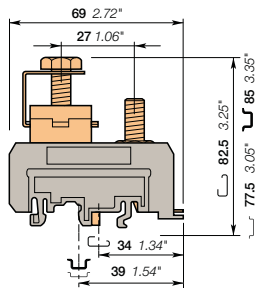

35 mm 1.380 in spacing

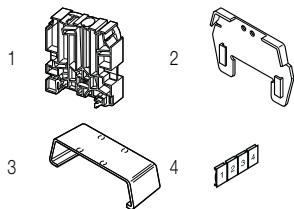

Description

- Compact one stud / one clamp terminal block,
- Lug mounting in accordance with NF C 20-130 and DIN 46234,
- Various marking options,
- Rail or base mounting.

Ordering details

Description	Color	Type	Part Number	Pkg pce	Weight (1 pce) g
Feed-through 1 stud M8 + 1 screw clamp	Grey <input type="checkbox"/>	M120/35.AF	1SNA115145R1400	10	160.00

Main technical data

Lugs	Rigid: Solid/Stranded Flexible with insulated ferrule Gauge	NFC	DIN	UL	CSA
		6-95 mm ²	2.5-70 mm ²	2-250 Kcmil	max 000 AWG
Screw clamp	Rigid: Solid/Stranded Flexible without ferrule Gauge	35-120 mm ² 35-70 mm ²	35-120 mm ² 35-70 mm ²	2-250 Kcmil	2-000 AWG

Bar	Rated current	Rated cross section	Rated voltage	Impulse withstand voltage	IEC	DIN	UL	CSA
					192 A	150 A	255 A	270 A
		70 mm ²	50 mm ²	250 Kcmil	000 AWG			
		1000 V		600 V	600 V			
		8000 V						

The connecting capacity data for one Rigid: Solid/Stranded, or one Flexible conductor (when applicable) is a mandatory information required by IEC, UL and CSA standards (Copper conductors). All other data are provided as supplementary information only. For more details, please consult our CB, UL or CSA certificates and technical datasheet available on <http://www.TE.com>

RoHS <input type="checkbox"/>	RoHS	USR <input type="checkbox"/>	USR	CSA <input type="checkbox"/>	CSA	Gost R <input type="checkbox"/>	Gost R
-------------------------------	------	------------------------------	-----	------------------------------	-----	---------------------------------	--------

Mounting instructions

Rail		G32, TH 35-7.5, TH 35-15
Lugs		Wrench H13 mm
Tool		
Torque		6-12 N.m 53.1-106.2 lb.in
Tool		
Torque		
Screw clamp		Wrench H13 mm
Tool		
Torque		7 ± 1 N.m 61.9 ± 8.85 lb.in
Wire stripping length		28 mm 1.102 in

Accessories

Description	Color	Type	Part Number	Pkg pce	Weight (1 pce) g
1 End stops	Grey <input type="checkbox"/>	BAMH	1SNA114836R0000	50	13.00
	Dark grey <input type="checkbox"/>	BAZH1	1SNK900102R0000	20	24.00
2 Circuit separators	Grey <input type="checkbox"/>	ECP35	1SNA113691R1600	10	10.00
3 Protecting covers	Transparent <input checked="" type="checkbox"/>	CPP351	1SNA168206R1700	5	8.00
		CPP352	1SNA168205R1600	5	20.00
		CPP353	1SNA163418R2600	5	20.00
4 Terminal block markers	Grey <input type="checkbox"/>	PEP	1SNA113762R2400	50	0.46
	White <input type="checkbox"/>	RC610	1SNA233000R0100	1	7.50

Complete list of accessories is indicated in the terminal block datasheet.

Some accessories such as jumper bars may modify the terminal block's ratings: complete information in the accessories catalogue pages.

Technical data valid for copper conductors only.

M300/42.AF stud terminal blocks

Feed-through - 42 mm 1.653 in spacing

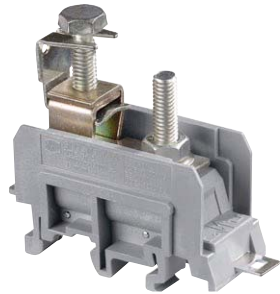

M300/42.AF

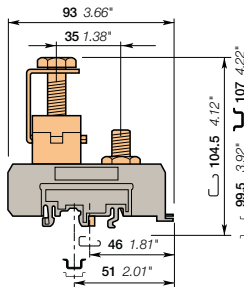

42 mm 1.653 in spacing

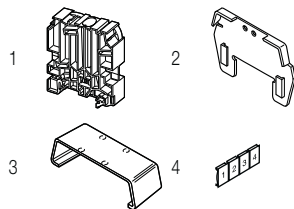

Description

- Compact one stud / one clamp terminal block,
- Lug mounting in accordance with NF C 20-130 and DIN 46234,
- Various marking options,
- Rail or base mounting.

Ordering details

Description	Color	Type	Part Number	Pkg pce	Weight (1 pce) g
Feed-through 1 stud M10 + 1 screw clamp	Grey <input type="checkbox"/>	M300/42.AF	1SNA115148R2700	10	340.00

Main technical data

Lugs	Rigid: Solid/Stranded Flexible with insulated ferrule Gauge	NFC	DIN	UL	CSA
		50-150 mm² 50-120 mm² C8	6-150 mm² 6-120 mm²	0-500 Kcmil	0-500 Kcmil

Screw clamp	Rigid: Solid/Stranded Flexible without ferrule Gauge	IEC	DIN	UL	CSA
		70-300 mm² 70-120 mm²	70-300 mm² 70-120 mm²	0-500 Kcmil	0-500 Kcmil

Mounting instructions

Rail		G32, TH 35-7.5, TH 35-15
Lugs Tool		Wrench H16 mm
Torque		10-20 N.m 88.5-177 lb.in
Jumper screw Tool		
Torque		
Screw clamp Tool		Wrench H16 mm
Torque		11 ± 1 N.m 97.36 ± 8.85 lb.in
Wire stripping length		40 mm 1.575 in

The connecting capacity data for one Rigid: Solid/Stranded, or one Flexible conductor (when applicable) is a mandatory information required by IEC, UL and CSA standards (Copper conductors). All other data are provided as supplementary information only. For more details, please consult our CB, UL or CSA certificates and technical datasheet available on <http://www.TE.com>

--	--	--	--

Accessories

Description	Color	Type	Part Number	Pkg pce	Weight (1 pce) g
1 End stops	Grey <input type="checkbox"/>	BAMH	1SNA114836R0000	50	13.00
	Dark grey <input type="checkbox"/>	BAZH1	1SNK900102R0000	20	24.00
2 Circuit separators	Grey <input type="checkbox"/>	ECP42	1SNA113692R1700	10	20.00
3 Protecting covers	Transparent <input checked="" type="checkbox"/>	CPP421	1SNA168208R2100	5	13.00
		CPP422	1SNA168207R1000	5	30.00
		CPP423	1SNA163424R1400	5	40.00
4 Terminal block markers	Grey <input type="checkbox"/>	PEP	1SNA113762R2400	50	0.46
	White <input type="checkbox"/>	RC610	1SNA233000R0100	1	7.50

Complete list of accessories is indicated in the terminal block datasheet. Some accessories such as jumper bars may modify the terminal block's ratings: complete information in the accessories catalogue pages.

Technical data valid for copper conductors only.

M35/26.F stud terminal blocks

Feed-through - 26 mm 1.024 in spacing

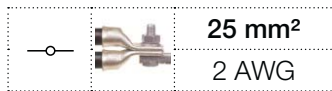

M35/26.F

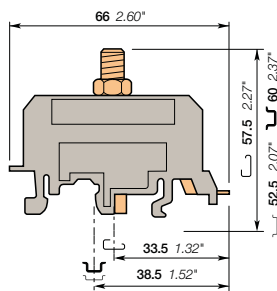

26 mm 1.024 in spacing

Description

- Compact one stud terminal block,
- Lug mounting in accordance with NF C 20-130 and DIN 46234,
- Various marking options,
- Rail or base mounting.

Ordering details

Description	Color	Type	Part Number	Pkg pce	Weight (1 pce) g
Feed-through 1 stud M6	Grey <input type="checkbox"/>	M35/26.F	1SNA115141R1000	10	40.00

Main technical data

Lugs	Rigid: Solid/Stranded Flexible with insulated ferrule Gauge	NFC	DIN	UL	CSA
		4-35 mm ²	2.5-50 mm ²	10-2 AWG	max 4 AWG
		4-25 mm ²	2.5-25 mm ²		
		C3			
Screw clamp	Rigid: Solid/Stranded Flexible without ferrule Gauge	IEC	DIN	UL	CSA
Bar	Rated current	101 A	125 A	115 A	125 A
		Rated cross section	25 mm ²	35 mm ²	2 AWG
	Rated voltage	1000 V		600 V	600 V
	Impulse withstand voltage	8000 V			

Mounting instructions

Rail		G32, TH 35-7.5, TH 35-15
Lugs		Wrench H10 mm
Tool		
Torque		4.5-9 N.m 39.8-79.6 lb.in
Jumper screw		
Tool		
Torque		
Screw clamp		
Tool		
Torque		
Wire stripping length		

The connecting capacity data for one Rigid: Solid/Stranded, or one Flexible conductor (when applicable) is a mandatory information required by IEC, UL and CSA standards (Copper conductors). All other data are provided as supplementary information only. For more details, please consult our CB, UL or CSA certificates and technical datasheet available on <http://www.TE.com>

RoHS		RoHS
USR		USR
CSA		CSA
Gost R		Gost R

Accessories

Description	Color	Type	Part Number	Pkg pce	Weight (1 pce) g
1 End stops	Grey <input type="checkbox"/>	BAMH	1SNA114836R0000	50	13.00
	Dark grey <input type="checkbox"/>	BAZH1	1SNK900102R0000	20	24.00
2 Circuit separators	Grey <input type="checkbox"/>	ECP26	1SNA113689R2400	10	6.40
3 Protecting covers	Transparent <input checked="" type="checkbox"/>	CPP261	1SNA168202R1300	5	5.00
		CPP262	1SNA168201R1200	5	10.00
		CPP263	1SNA163403R2000	5	17.00
4 Terminal block markers	Grey <input type="checkbox"/>	PEP	1SNA113762R2400	50	0.46
	White <input type="checkbox"/>	RC610	1SNA233000R0100	1	7.50

Complete list of accessories is indicated in the terminal block datasheet.

Some accessories such as jumper bars may modify the terminal block's ratings: complete information in the accessories catalogue pages.

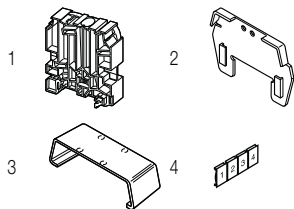

Technical data valid for copper conductors only.

M70/31.F stud terminal blocks

Feed-through - 31 mm 1.220 in spacing

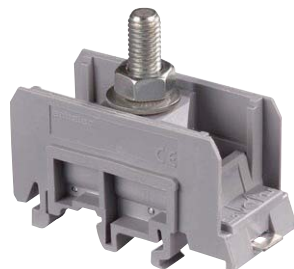
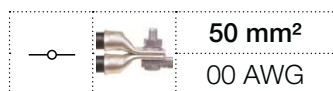

M70/31.F

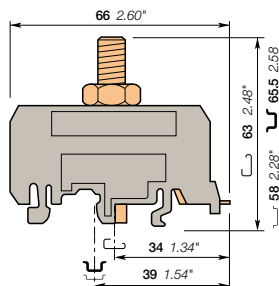

31 mm 1.220 in spacing

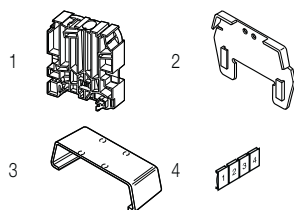

Description

- Compact one stud terminal block,
- Lug mounting in accordance with NF C 20-130 and DIN 46234,
- Various marking options,
- Rail or base mounting.

Ordering details

Description	Color	Type	Part Number	Pkg pce	Weight (1 pce) g
Feed-through 1 stud M8	Grey <input type="checkbox"/>	M70/31.F	1SNA115144R1300	10	60.00

Main technical data

Lugs	Rigid: Solid/Stranded Flexible with insulated ferrule Gauge	NFC	DIN	UL	CSA
		6-70 mm ² 6-50 mm ² C5	2.5-70 mm ² 2.5-50 mm ²	4-00 AWG	max 0 AWG
Screw clamp	Rigid: Solid/Stranded Flexible without ferrule Gauge	IEC	DIN	UL	CSA
Bar	Rated current Rated cross section Rated voltage Impulse withstand voltage	IEC	DIN	UL	CSA
		150 A 50 mm ² 1000 V 8000 V	150 A 50 mm ²	175 A 00 AWG 600 V	200 A 0 AWG 600 V

Mounting instructions

Rail		G32, TH 35-7.5, TH 35-15
Lugs		Wrench H13 mm
Tool		
Torque		6-12 N.m 53.1-106.2 lb.in
Jumper screw		
Tool		
Torque		
Screw clamp		
Tool		
Torque		
Wire stripping length		

The connecting capacity data for one Rigid: Solid/Stranded, or one Flexible conductor (when applicable) is a mandatory information required by IEC, UL and CSA standards (Copper conductors). All other data are provided as supplementary information only. For more details, please consult our CB, UL or CSA certificates and technical datasheet available on <http://www.TE.com>

--	--	--	--

Accessories

Description	Color	Type	Part Number	Pkg pce	Weight (1 pce) g
1 End stops	Grey <input type="checkbox"/>	BAMH	1SNA114836R0000	50	13.00
	Dark grey <input type="checkbox"/>	BAZH1	1SNK900102R0000	20	24.00
2 Circuit separators	Grey <input type="checkbox"/>	ECP31	1SNA113690R2100	10	6.70
3 Protecting covers	Transparent <input checked="" type="checkbox"/>	CPP311	1SNA168204R1500	5	7.00
		CPP312	1SNA168203R1400	5	14.00
		CPP313	1SNA163409R0600	5	23.00
4 Terminal block markers	Grey <input type="checkbox"/>	PEP	1SNA113762R2400	50	0.46
	White <input type="checkbox"/>	RC610	1SNA233000R0100	1	7.50

Complete list of accessories is indicated in the terminal block datasheet. Some accessories such as jumper bars may modify the terminal block's ratings: complete information in the accessories catalogue pages.

Technical data valid for copper conductors only.

M120/35.F stud terminal blocks

Feed-through - 35 mm 1.380 in spacing

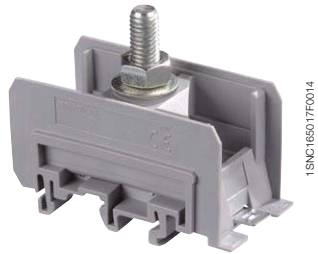
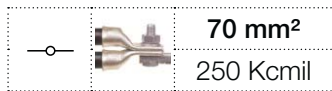

M120/35.F

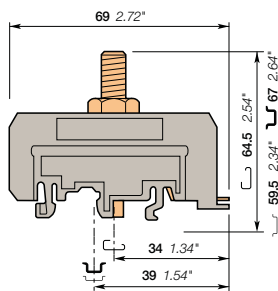

35 mm 1.380 in spacing

Description

- Compact one stud terminal block,
- Lug mounting in accordance with NF C 20-130 and DIN 46234,
- Various marking options,
- Rail or base mounting.

Ordering details

Description	Color	Type	Part Number	Pkg pce	Weight (1 pce) g
Feed-through 1 stud M8	Grey <input type="checkbox"/>	M120/35.F	1SNA115147R1600	10	61.00

Main technical data

Lugs	Rigid: Solid/Stranded Flexible with insulated ferrule Gauge	NFC	DIN	UL	CSA		
		6-95 mm²	2.5-70 mm²	2-250 Kcmil	max 000 AWG		
		IEC	DIN	UL	CSA		
Screw clamp	Rigid: Solid/Stranded Flexible without ferrule Gauge			IEC	DIN	UL	CSA
Bar	Rated current	IEC	DIN	UL	CSA		
		192 A	150 A	255 A	270 A		
Rated cross section		70 mm²	50 mm²	250 Kcmil	000 AWG		
Rated voltage		1000 V		600 V	600 V		
Impulse withstand voltage		8000 V					

Mounting instructions

Rail		G32, TH 35-7.5, TH 35-15
Lugs		Wrench H13 mm
Tool		
Torque		6-12 N.m 53.1-106.2 lb.in
Jumper screw		
Tool		
Torque		
Screw clamp		
Tool		
Torque		
Wire stripping length		

The connecting capacity data for one Rigid: Solid/Stranded, or one Flexible conductor (when applicable) is a mandatory information required by IEC, UL and CSA standards (Copper conductors). All other data are provided as supplementary information only. For more details, please consult our CB, UL or CSA certificates and technical datasheet available on <http://www.TE.com>

RoHS		RoHS
USR		USR
CSA		CSA
Gost R		Gost R

Accessories

Description	Color	Type	Part Number	Pkg pce	Weight (1 pce) g
1 End stops	Grey <input type="checkbox"/>	BAMH	1SNA114836R0000	50	13.00
	Dark grey <input type="checkbox"/>	BAZH1	1SNK900102R0000	20	24.00
2 Circuit separators	Grey <input type="checkbox"/>	ECP35	1SNA113691R1600	10	10.00
3 Protecting covers	Transparent <input checked="" type="checkbox"/>	CPP351	1SNA168206R1700	5	8.00
		CPP352	1SNA168205R1600	5	20.00
		CPP353	1SNA163418R2600	5	20.00
4 Terminal block markers	Grey <input type="checkbox"/>	PEP	1SNA113762R2400	50	0.46
	White <input type="checkbox"/>	RC610	1SNA233000R0100	1	7.50

Complete list of accessories is indicated in the terminal block datasheet. Some accessories such as jumper bars may modify the terminal block's ratings: complete information in the accessories catalogue pages.

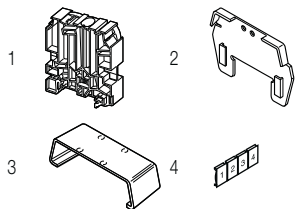

Technical data valid for copper conductors only.

M300/42.F stud terminal blocks

Feed-through - 42 mm 1.653 in spacing

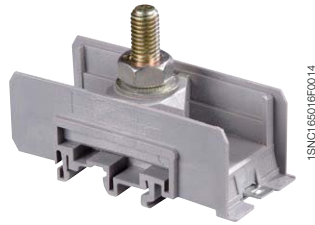

M300/42.F

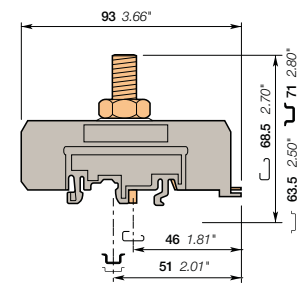

42 mm 1.653 in spacing

Description

- Compact one stud terminal block,
- Lug mounting in accordance with NF C 20-130 and DIN 46234,
- Various marking options,
- Rail or base mounting.

Ordering details

Description	Color	Type	Part Number	Pkg pce	Weight (1 pce) g
Feed-through 1 stud M10	Grey <input type="checkbox"/>	M300/42.F	1SNA115150R2500	10	100.00

Main technical data

Lugs	Rigid: Solid/Stranded Flexible with insulated ferrule Gauge	NFC	DIN	UL	CSA
		50-150 mm² 50-120 mm² C8	6-150 mm² 6-120 mm²	0-500 Kcmil	max 500 Kcmil
Screw clamp	Rigid: Solid/Stranded Flexible without ferrule Gauge	IEC	DIN	UL	CSA
Bar	Rated current Rated cross section Rated voltage Impulse withstand voltage	IEC	DIN	UL	CSA
		269 A 120 mm² 1000 V 8000 V	269 A 120 mm²	230 A 500 Kcmil 600 V	550 A 500 Kcmil 600 V

Mounting instructions

Rail		G32, TH 35-7.5, TH 35-15
Lugs		Wrench H16 mm
Tool		
Torque		10-20 N.m 88.5-177 lb.in
Jumper screw		
Tool		
Torque		
Screw clamp		
Tool		
Torque		
Wire stripping length		

The connecting capacity data for one Rigid: Solid/Stranded, or one Flexible conductor (when applicable) is a mandatory information required by IEC, UL and CSA standards (Copper conductors). All other data are provided as supplementary information only. For more details, please consult our CB, UL or CSA certificates and technical datasheet available on <http://www.TE.com>

--	--	--

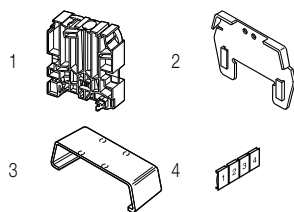

Accessories

Description	Color	Type	Part Number	Pkg pce	Weight (1 pce) g
1 End stops	Grey <input type="checkbox"/>	BAMH	1SNA114836R0000	50	13.00
	Dark grey <input type="checkbox"/>	BAZH1	1SNK900102R0000	20	24.00
2 Circuit separators	Grey <input type="checkbox"/>	ECP42	1SNA113692R1700	10	20.00
3 Protecting covers	Transparent <input checked="" type="checkbox"/>	CPP421	1SNA168208R2100	5	13.00
		CPP422	1SNA168207R1000	5	30.00
		CPP423	1SNA163424R1400	5	40.00
4 Terminal block markers	Grey <input type="checkbox"/>	PEP	1SNA113762R2400	50	0.46
	White <input type="checkbox"/>	RC610	1SNA233000R0100	1	7.50

Complete list of accessories is indicated in the terminal block datasheet. Some accessories such as jumper bars may modify the terminal block's ratings: complete information in the accessories catalogue pages.

Technical data valid for copper conductors only.

TE Connectivity's "positive retention" lock foot

Mounting instructions

Mounting

The locking action is automatic on mounting the block on the rail.

Unlocking

- Pull or push on the locking tag, using pliers as follows
- Blocks mounted on DIN 1 rail: pull on the release tag
- Blocks mounted on DIN 3 rails: push on the release tag
- Remove the block from the rail by rotation, using a tube wrench while maintaining the action of the pliers.

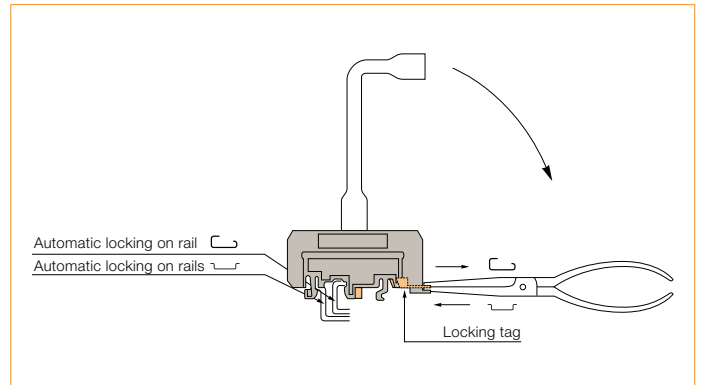

Space requirements of blocks with their partition or protective cover

Partition for TYPE I blocks

Type	Part Number	Spacing	A	B	C	D	E	F
Dimensions mm								
ECP26	1SNA113689R2400	26	76	35.5	40.5	67.5	62.5	70
ECP31	1SNA113690R2100	31	84	39.5	44.5	72.5	67.5	75
ECP35	1SNA113691R1600	35	90	42.5	47.5	82.5	77.5	85
ECP42	1SNA113692R1700	42	116	55.5	60.5	104.5	99.5	107

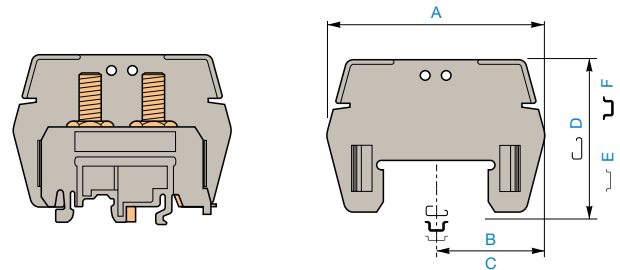

Marker-holder for power blocks

This marker-holder snaps on the ECP and ECS power blocks partitions, as well as on the type I power blocks compression clamps.

They can also be mounted on the SCF separator end sections.

Type	Part Number
PEP	1SNA113762R2400

This marker-holder can receive:
1 label RC610

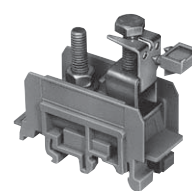

Adhesive marker

High performance adhesive marker for most surface types.
See section on markers.

Type	Oder code
RPA	1SNA235463R2300



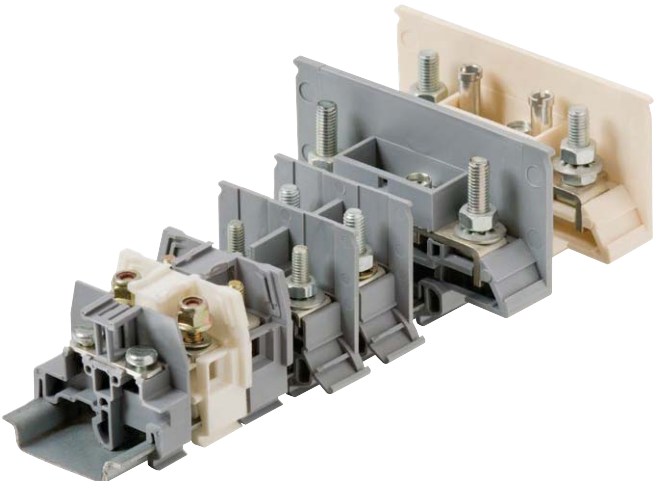

1SNC166014S0201

Dedicated applications terminal blocks

Ring lug technology



Overview 100

Feed-through	
6 mm ² / 8 AWG	M6/9.EE 101
	M6/12.FF 102
	M6/13.FF 103 to 104

Feed-through	
16 mm ²	165LTTM5TM5 105

Test disconnect	
16 mm ²	165ETTM5TM5 With a screwdriver sliding link 106
	165ETTM5TM5-2 With a screwdriver sliding link and test 107

Dedicated applications terminal blocks

Ring lug technology

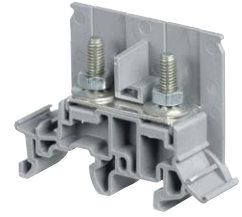
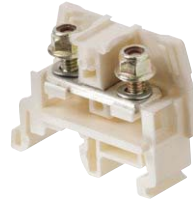

Feed-through

Section				
IEC	UL/CSA			
6 mm²	8 AWG	M6/9.EE 9.5 mm 0.374 in	M6/12.FF 12.5 mm 0.492 in	M6/13.FF 13 mm 0.512 in

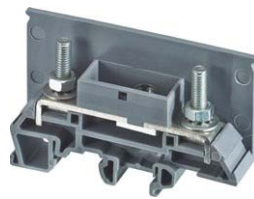

Feed-through

Test disconnect

Section				
IEC	UL/CSA			
16 mm²		165LTTM5TM5 16 mm 0.630 in	165ETTM5TM5 16 mm 0.630 in	165ETTM5TM5-2 16 mm 0.630 in

M6/9.EE ring lug terminal blocks

Feed-through - 9.5 mm 0.374 in spacing

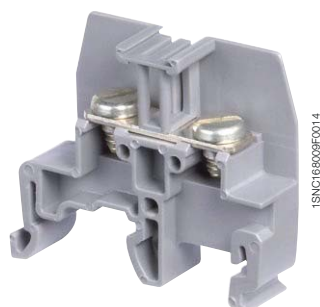
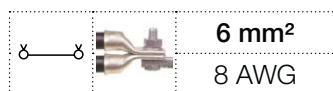

M6/9.EE

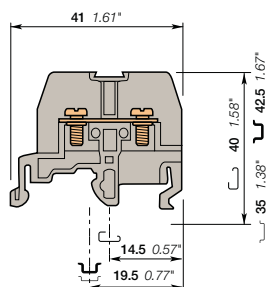

9.5 mm 0.374 in spacing

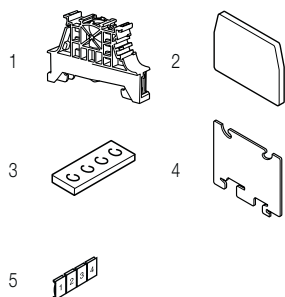

Description

- Strap screw terminal block for ring lug connection
- Removable partition for jumpering.

Ordering details

Description	Color	Type	Part Number	Pkg pce	Weight (1 pce) g
Feed-through With 2 screws CL 6-32 NC - 2A DIA 3.5 mm 0.138 in for lug max width 8.5 mm 0.334 in	Grey <input type="checkbox"/>	M6/9.EE	1SNA115201R2500	50	7.00

Main technical data

	IEC	UL	CSA
Lugs	Rigid: Solid/Stranded Flexible with insulated ferrule Gauge	0.5-6 mm ² 0.5-6 mm ²	22-8 AWG max 8 AWG
Rated current	41 A	40 A	40 A
Rated cross section	6 mm ²	22-8 AWG	8 AWG
Rated voltage	800 V	600 V	600 V
Impulse withstand voltage	8 kV		
Protection		NEMA	

Mounting instructions

Rail		G32, TH 35-7.5, TH 35-15
Lugs		Flat screwdriver
Tool		6.35 mm 0.250 in
Torque		0.8 - 1 N.m 7.1 - 8.9 lb.in
Wire stripping length		

The connecting capacity data for one Rigid: Solid/Stranded, or one Flexible conductor (when applicable) is a mandatory information required by IEC, UL and CSA standards (Copper conductors). All other data are provided as supplementary information only. For more details, please consult our CB, UL or CSA certificates and technical datasheet available on <http://www.TE.com>

RoHS	RoHS	USR	CSA	EAC	EAC
------	------	-----	-----	-----	-----

Accessories

Description	Color	Type	Part Number	Pkg pce	Weight (1 pce) g	
1 End stops	Dark grey <input type="checkbox"/>	BAM4	1SNK900001R0000	50	14.00	
		BAZ1	1SNK900002R0000	50	5.30	
2 End sections	Grey <input type="checkbox"/>	FEM9	1SNA113067R1700	1	2.40	
3 Jumper bars	Grey <input type="checkbox"/>	2 poles	BJS9.5-2	1SNA173815R1600	10	1.00
		3 poles	BJS9.5-3	1SNA173816R1700	10	1.60
		4 poles	BJS9.5-4	1SNA173817R1000	10	2.20
		10 poles	BJS9.5-10	1SNA173819R2200	10	5.60
4 Circuit separators	White <input type="checkbox"/>	SCF9	1SNA103672R0100	20	2.00	
5 Terminal block markers	White <input type="checkbox"/>	RCT810	1SNA236500R0600	1	7.60	

Complete list of accessories is indicated in the terminal block datasheet.
 Some accessories such as jumper bars may modify the terminal block's ratings: complete information in the accessories catalogue pages.

Technical data valid for copper conductors only.

M6/12.FF ring lug terminal blocks

Feed-through - 12.5 mm 0.492 in spacing

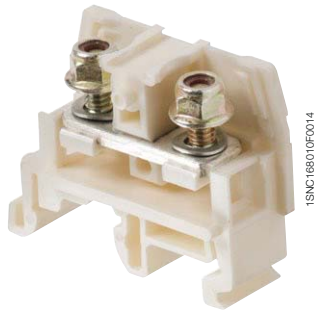
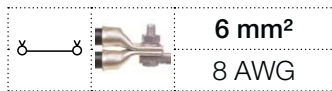

M6/12.FF

Description

- Terminal block for high vibration environment,
- Stud connection
- Removable partition for jumpering.

Ordering details

Description	Color	Type	Part Number	Pkg pce	Weight (1 pce) g
Feed-through With nuts, with 2 studs 8-32 UNC - 2A DIA 4.16 mm 0.164 in, height 9 mm 0.354 in, for lug max width 9.5 mm 0.374 in	White <input type="checkbox"/>	M6/12.FF	1SNA115263R2200	50	20.00
	Grey <input type="checkbox"/>	M6/12.FF	1SNA400753R1000	50	20.00
Without nuts, with 2 studs 8-32 UNC - 2A DIA 4.16 mm 0.164 in, height 9 mm 0.354 in, for lug max width 9.5 mm 0.374 in	Grey <input type="checkbox"/>	M6/12.FF	1SNA115511R0300	50	13.00
	White <input type="checkbox"/>	M6/12.FF1	1SNA115262R2100	50	13.00

Main technical data

	IEC	UL	CSA
Lugs	Rigid: Solid/Stranded Flexible with insulated ferrule Gauge	max 6 mm ² 8 AWG	18-10 AWG
Rated current	41 A	40 A	25 A
Rated cross section	6 mm ²	8 AWG	10 AWG
Rated voltage	800 V	600 V	600 V
Impulse withstand voltage	8 kV		
Protection		NEMA	

Mounting instructions

Rail		G32, TH 35-7.5, TH 35-15
Lugs		Wrench
Tool		
Torque		1.8 N.m 15.65 lb.in
Wire stripping length		

The connecting capacity data for one Rigid: Solid/Stranded, or one Flexible conductor (when applicable) is a mandatory information required by IEC, UL and CSA standards (Copper conductors). All other data are provided as supplementary information only. For more details, please consult our CB, UL or CSA certificates and technical datasheet available on <http://www.TE.com>

RoHS	USR	cCSAus	EAC
------	-----	--------	-----

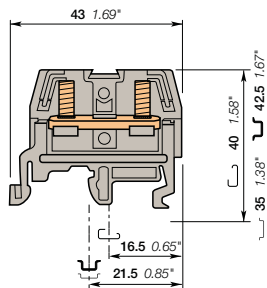

12.5 mm 0.492 in spacing

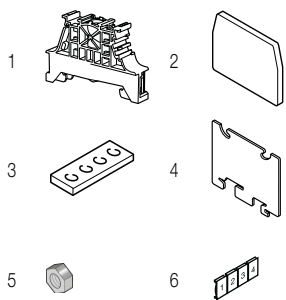

Accessories

Description	Color	Type	Part Number	Pkg pce	Weight (1 pce) g
1 End stops	Dark grey <input checked="" type="checkbox"/>	BAM4	1SNK900001R0000	50	14.00
		BAZ1	1SNK900002R0000	50	5.30
2 End sections	Grey <input type="checkbox"/>	FEM12F	1SNA116713R1600	25	1.25
3 Jumper bars		2 poles	BJS12.5-2	10	1.70
		3 poles	BJS12.5-3	10	2.70
		5 poles	BJS12.5-5	10	4.80
		10 poles	BJS12.5-10	10	9.90
4 Circuit separators	White <input type="checkbox"/>	SCF9	1SNA103672R0100	20	2.00
5 Nuts		ECR-3	1SNA175263T0600	100	1.00
6 Terminal block markers	White <input type="checkbox"/>	RCT810	1SNA236500R0600	1	7.60

Complete list of accessories is indicated in the terminal block datasheet.
Some accessories such as jumper bars may modify the terminal block's ratings: complete information in the accessories catalogue pages.

Technical data valid for copper conductors only.

M6/13.FF ring lug terminal blocks

Feed-through - 13 mm 0.512 in spacing

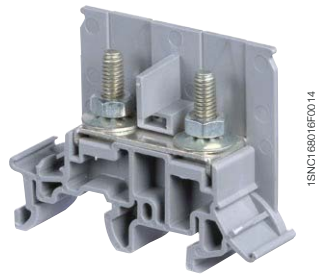
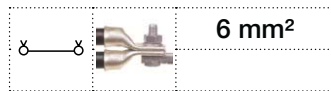

M6/13.FF

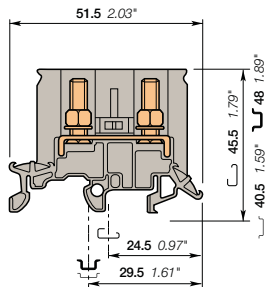

13 mm 0.512 in spacing

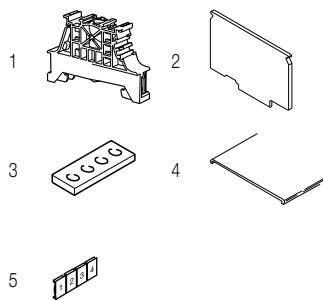

Description

- Two stud terminal block for ring lug connection
- Removable partition for jumpering.

Ordering details

Description	Color	Type	Part Number	Pkg pce	Weight (1 pce) g
Feed-through With 2 studs M4 x 16	Grey <input type="checkbox"/>	M6/13.FF	1SNA115626R1600	25	16.00

Main technical data

	IEC	UL	CSA
Lugs	Rigid: Solid/Stranded max 6 mm ² Flexible with insulated ferrule max 6 mm ² Gauge	10 AWG	18-10 AWG
Rated current	41 A	35 A	25 A
Rated cross section	6 mm ²	10 AWG	18-10 AWG
Rated voltage	800 V	600 V	600 V
Impulse withstand voltage	8 kV		
Protection		NEMA	

Mounting instructions

Rail		G32, TH 35-7.5, TH 35-15
Lugs		Flat screwdriver Ø 6.35 mm Ø 0.250 in
Tool		
Torque		1.2 - 2.5 N.m 10.6 - 21.8 lb.in
Wire stripping length		

The connecting capacity data for one Rigid: Solid/Stranded, or one Flexible conductor (when applicable) is a mandatory information required by IEC, UL and CSA standards (Copper conductors). All other data are provided as supplementary information only. For more details, please consult our CB, UL or CSA certificates and technical datasheet available on <http://www.TE.com>

RoHS		RoHS
USR		USR
cCSAus		cCSAus
EAC		EAC

Accessories

Description	Color	Type	Part Number	Pkg pce	Weight (1 pce) g
1 End stops	Dark grey <input checked="" type="checkbox"/>	BAM4	1SNK900001R0000	50	14.00
		BAZ1	1SNK900002R0000	50	5.30
2 End sections	Grey <input type="checkbox"/>	FEM13F	1SNA116977R1700	25	1.40
3 Jumper bars		BJS13-10	1SNA167224R2700	10	10.00
4 Protecting covers		CPE43	1SNA280092R2500	2	
5 Terminal block markers	White <input type="checkbox"/>	RC1010	1SNA238000R1600	1	1.30

Complete list of accessories is indicated in the terminal block datasheet.

Some accessories such as jumper bars may modify the terminal block's ratings: complete information in the accessories catalogue pages.

Technical data valid for copper conductors only.

M6/13.FF ring lug terminal blocks

Feed-through - 13 mm 0.512 in spacing

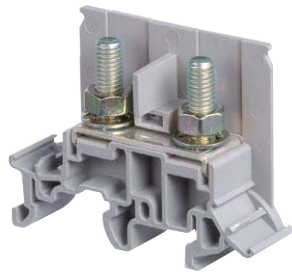
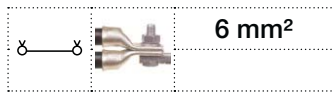

M6/13.FF

1SNC180015F0014

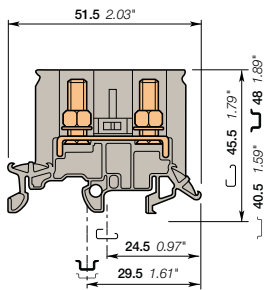

13 mm 0.512 in spacing

Description

- Two stud terminal block for ring lug connection
- Removable partition for jumpering.

Ordering details

Description	Color	Type	Part Number	Pkg pce	Weight (1 pce) g
Feed-through With 2 studs M5 x 16	Grey <input type="checkbox"/>	M6/13.FF.1	1SNA115627R1700	25	16.00

Main technical data

	IEC	UL	CSA
Lugs	Rigid: Solid/Stranded max 10 mm ² Flexible with insulated ferrule max 10 mm ² Gauge	8 AWG	18-10 AWG
Rated current	57 A	50 A	25 A
Rated cross section	10 mm ²	8 AWG	18-10 AWG
Rated voltage	800 V	600 V	600 V
Impulse withstand voltage	8 kV		
Protection		NEMA	

Mounting instructions

Rail		G32, TH 35-7.5, TH 35-15
Lugs		Wrench
Tool		H8 mm 0.310 in
Torque		2 - 4 N.m 17.7 - 35.4 lb.in
Wire stripping length		

The connecting capacity data for one Rigid: Solid/Stranded, or one Flexible conductor (when applicable) is a mandatory information required by IEC, UL and CSA standards (Copper conductors). All other data are provided as supplementary information only. For more details, please consult our CB, UL or CSA certificates and technical datasheet available on <http://www.TE.com>

RoHS: <input type="checkbox"/>	RoHS <input type="checkbox"/>	USR <input type="checkbox"/>	cCSAus <input type="checkbox"/>	EAC <input type="checkbox"/>						
--------------------------------	-------------------------------	------------------------------	---------------------------------	------------------------------	--	--	--	--	--	--

Accessories

Description	Color	Type	Part Number	Pkg pce	Weight (1 pce) g
1 End stops	Dark grey <input type="checkbox"/>	BAM4	1SNK900001R0000	50	14.00
		BAZ1	1SNK900002R0000	50	5.30
2 End sections	Grey <input type="checkbox"/>	FEM13F	1SNA116977R1700	25	1.40
3 Jumper bars		BJS13-10	1SNA167224R2700	10	10.00
4 Protecting covers		CPE43	1SNA280092R2500	2	
5 Terminal block markers	White <input type="checkbox"/>	RC1010	1SNA238000R1600	1	1.30

Complete list of accessories is indicated in the terminal block datasheet.
Some accessories such as jumper bars may modify the terminal block's ratings: complete information in the accessories catalogue pages.

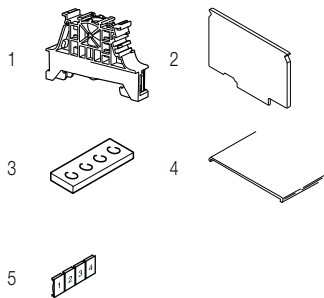

Technical data valid for copper conductors only.

165LTTM5TM5 ring lug terminal blocks

Feed-through - 16 mm 0.630 in spacing

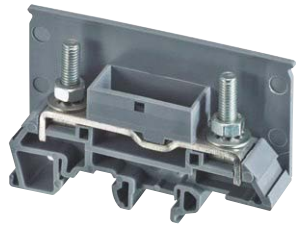
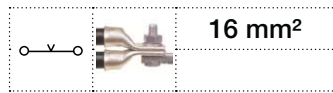

165LTTM5TM5

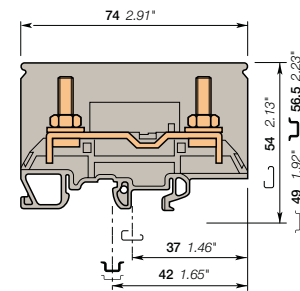

16 mm 0.630 in spacing

Description

- Two stud terminal block for ring lug connection,
- Profile aligned with disconnect terminal blocks type 165ETTM5TM5.

Ordering details

Description	Color	Type	Part Number	Pkg pce	Weight (1 pce) g
Feed-through With 2 studs M5 x 16 and partition	Grey <input type="checkbox"/>	165LTTM5TM5	1SNA216110R2200	25	40.00

Main technical data

	IEC	UL	CSA	Mounting instructions	
Lugs	Rigid: Solid/Stranded 16 mm ² Flexible with insulated ferrule 16 mm ² Gauge	6 AWG		Rail	G32, TH 35-7.5, TH 35-15
Rated current	76 A	65 A		Lugs	Wrench H8 mm 0.310 in
Rated cross section	16 mm ²	6 AWG		Tool	2 - 4 N.m 17.7 - 35.4 lb.in
Rated voltage	800 V	600 V		Torque	
Impulse withstand voltage	8 kV			Wire stripping length	
Protection		NEMA			

The connecting capacity data for one Rigid: Solid/Stranded, or one Flexible conductor (when applicable) is a mandatory information required by IEC, UL and CSA standards (Copper conductors). All other data are provided as supplementary information only. For more details, please consult our CB, UL or CSA certificates and technical datasheet available on <http://www.TE.com>

--	--	--

Accessories

Description	Color	Type	Part Number	Pkg pce	Weight (1 pce) g
1 End stops	Dark grey <input type="checkbox"/>	BAM4	1SNK900001R0000	50	14.00
		BAZ1	1SNK900002R0000	50	5.30
2 End sections	Grey <input type="checkbox"/>	FEET80	1SNA216114R1200	10	7.20
3 Test sockets		AL4-M3-R1	1SNA206722R0200	50	1.62
4 Protecting covers		CPE80	1SNA280093R2600	1	103.00
5 Terminal block markers		REH3	1SNA163155R2600	1	20.00

Complete list of accessories is indicated in the terminal block datasheet.

Some accessories such as jumper bars may modify the terminal block's ratings: complete information in the accessories catalogue pages.

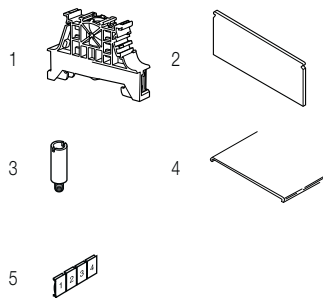

Technical data valid for copper conductors only.

165ETTM5TM5 ring lug terminal blocks

Test disconnect with a screwdriver sliding link - 16 mm 0.630 in spacing

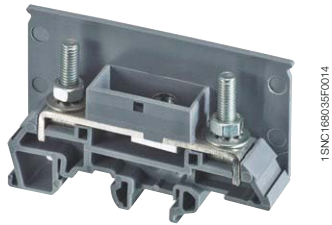
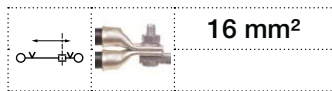

165ETTM5TM5

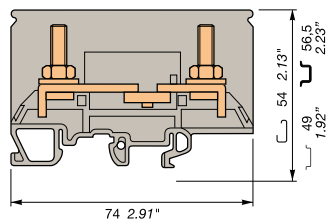

16 mm 0.630 in spacing

Description

- Secure your disconnect operations with the disconnect sliding link operated with a screwdriver.
- Two stud terminal block for ring lug connection.
- Profile aligned with terminal blocks type 165LTTM5TM5

Ordering details

Description	Color	Type	Part Number	Pkg pce	Weight (1 pce)
Disconnect With 2 studs M5 x 18 fitted with 1 nut + 1 lock washer	Grey	165ETTM5TM5	1SNA216112R1000	25	22.00

Main technical data

		IEC	UL	CSA
Lugs	Rigid: Solid/Stranded	16 mm²		
	Flexible with insulated ferrule Gauge	16 mm²		
Rated current		76 A		
Rated cross section		16 mm²		
Rated voltage		800 V		
Impulse withstand voltage		8 kV		
Protection			NEMA	

Mounting instructions

Rail		G32, TH 35-7.5, TH 35-15
Lugs Tool		Wrench H8 mm 0.310 in
Torque		2 - 4 N.m 17.7 - 35.4 lb.in
Disconnect device Tool		Flat screwdriver Ø 4 mm 0.157 in
Torque		0.5 - 0.8 N.m 4.4 - 7.1 lb.in
Wire stripping length		

The connecting capacity data for one Rigid: Solid/Stranded, or one Flexible conductor (when applicable) is a mandatory information required by IEC, UL and CSA standards (Copper conductors). All other data are provided as supplementary information only. For more details, please consult our CB, UL or CSA certificates and technical datasheet available on <http://www.TE.com>

RoHS	RoHS	RoHS	RoHS	RoHS	RoHS	RoHS	RoHS	RoHS	RoHS
RoHS	RoHS	RoHS	RoHS	RoHS	RoHS	RoHS	RoHS	RoHS	RoHS

Accessories

Description	Color	Type	Part Number	Pkg pce	Weight (1 pce)
1 End stops	Dark grey	BAM4	1SNK900001R0000	50	14.00
		BAZ1	1SNK900002R0000	50	5.30
2 End sections	Grey	FEET80	1SNA216114R1200	10	7.20
3 Test sockets		AL4-M3-R1	1SNA206722R0200	50	1.62
4 Protecting covers		CPE80	1SNA280093R2600	1	103.00
5 Terminal block markers		REH3	1SNA163155R2600	1	20.00

Complete list of accessories is indicated in the terminal block datasheet. Some accessories such as jumper bars may modify the terminal block's ratings: complete information in the accessories catalogue pages.

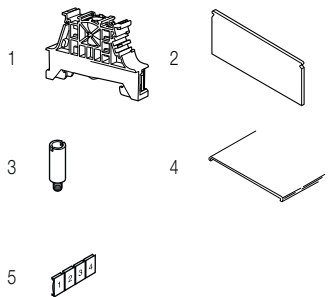

Feed-through wire lug terminal blocks

Description	Color	Type	Part Number	Pkg pce	Weight (1 pce)
Feed-through	Grey	165LTTM5TM5	1SNA216110R2200	25	40.00

Technical data valid for copper conductors only.

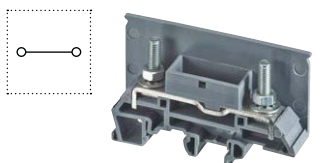

165ETTM5TM5 ring lug terminal blocks

Test disconnect with a screwdriver sliding link - 16 mm 0.630 in spacing

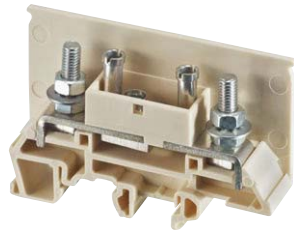
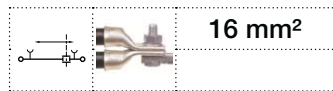

1SNC1680390014

165ETTM5TM5

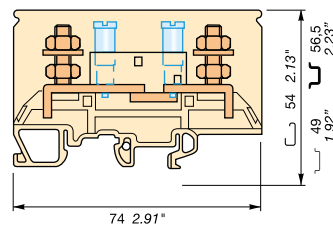

16 mm 0.630 in spacing

Description

- Secure your disconnect operations with the disconnect sliding link operated with a screwdriver,
- Ease your test operations with the 2 independent built-in test sockets compatible with DIA 4 mm 0.157 in test plugs,
- Two stud terminal block for ring lug connection,
- Profile aligned with terminal blocks type 165LTTM5TM5.

Ordering details

Description	Color	Type	Part Number	Pkg pce	Weight (1 pce) g
Disconnect With 2 studs M5 x 18 fitted with 2 nuts + 1 washer, with test sockets DIA 4 mm 0.157 in	Beige	165ETTM5TM5-2	1SNA296117R1600	25	51.00

Main technical data

	IEC	UL	CSA
Lugs Rigid: Solid/Stranded	16 mm ²		
Flexible with insulated ferrule Gauge	16 mm ²		
Rated current	76 A		
Rated cross section	16 mm ²		
Rated voltage	800 V		
Impulse withstand voltage	8 kV		
Protection		NEMA	

Mounting instructions

Rail		G32, TH 35-7.5, TH 35-15
Lugs		Wrench H8 mm 0.310 in
Tool		2 - 4 N.m 17.7 - 35.4 lb.in
Torque		
Disconnect device		Flat screwdriver Ø 4 mm Ø 0.157 in
Tool		0.5 - 0.8 N.m 4.4 - 7.1 lb.in
Torque		
Wire stripping length		

The connecting capacity data for one Rigid: Solid/Stranded, or one Flexible conductor (when applicable) is a mandatory information required by IEC, UL and CSA standards (Copper conductors). All other data are provided as supplementary information only. For more details, please consult our CB, UL or CSA certificates and technical datasheet available on <http://www.TE.com>

RoHS		Gost R					
------	--	--------	--	--	--	--	--

Accessories

Description	Color	Type	Part Number	Pkg pce	Weight (1 pce) g
1 End stops 10 mm 0.079 in	Dark grey	BAM4	1SNK900001R0000	50	14.00
5.2 mm 0.205 in		BAZ1	1SNK900002R0000	50	5.30
2 End sections 2 mm 0.079 in	Beige	FEET80	1SNA296114R1300	10	7.20
3 Protecting covers Length 2 m 78 in		CPE80	1SNA280093R2600	1	103.00
4 Terminal block markers Blank card		REH3	1SNA163155R2600	1	20.00

Complete list of accessories is indicated in the terminal block datasheet. Some accessories such as jumper bars may modify the terminal block's ratings: complete information in the accessories catalogue pages.

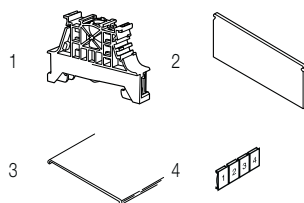

Technical data valid for copper conductors only.

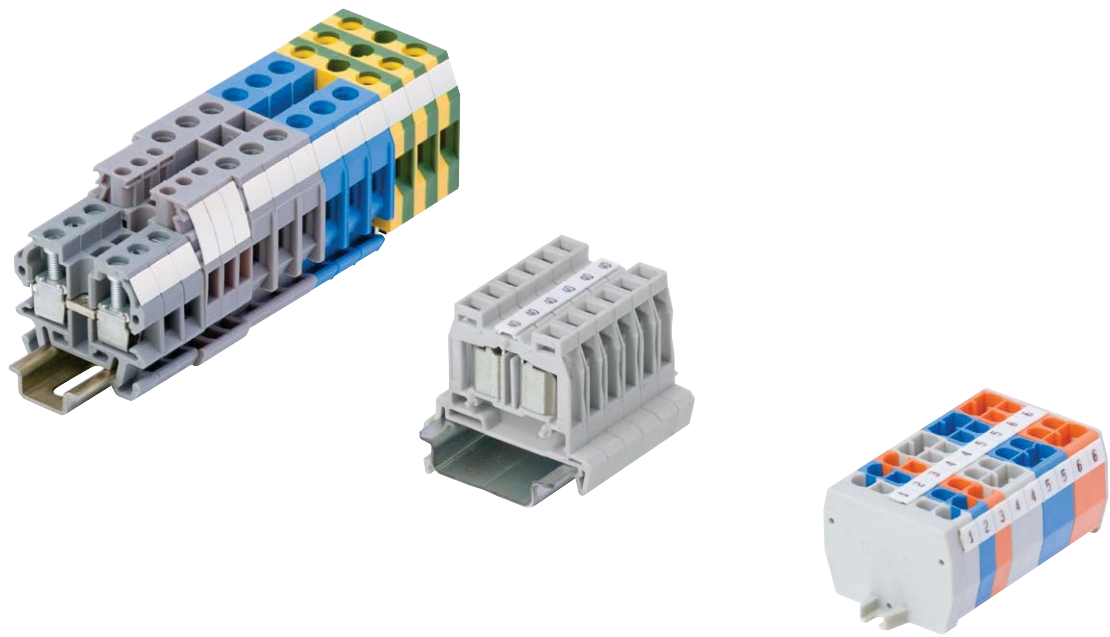

Dedicated applications terminal blocks

Miniblocks



Overview

110

Screw clamp technology

Rail TH 35				
Feed-through	4 mm ² / 10-12 AWG	MS4/6		112
	6 mm ² / 8 AWG	MS6/8		113
Rail TH 15				
Feed-through	1.5 mm ² / 12 AWG	DR1.5/4		114
		DR1.5/5		115
	4 mm ² / 10-12 AWG	DR4/6		117
Ground	4 mm ² / 10-12 AWG	DR4/6.P		119
Disconnect	2.5 mm ² / 12 AWG	DR2.5/5.S		120
Fuse	4 mm ² / 12 AWG	DR4/8.SF		121

Spring clamp technology

Rail TH 35				
Feed-through	2.5 mm ² / 12 AWG	DS2.5/5.2L	2 connections	122
		DS2.5/10.4L	4 connections	123
Rail TH 15				
Feed-through	2.5 mm ² / 12 AWG	DR2.5/5.2L	2 connections	124
		DR2.5/10.4L	4 connections	125
Ground	2.5 mm ² / 12 AWG	DR2.5/10.P.4L	4 connections	126
Base mounting				
Feed-through	2.5 mm ² / 12 AWG	DB2.5/5.2L	2 connections with flanges mounting	127
		DH2.5/5.2L	2 connections with snap in foot	128

ADO / screw clamp technology

Rail TH 35				
Feed-through	1 mm ² / 18 AWG	DS2.5/5.ADO & DSE2.5/5.ADO		129
	1.5 mm ² / 16 AWG	DS4/6.ADO & DSE4/6.ADO		130
	2.5 mm ² / 14 AWG	DS4/8.ADO & DSE4/8.ADO		131
Ground	2.5 mm ² / 14 AWG	DS4/8.P.ADO		132
Rail TH 15				
Feed-through	1 mm ² / 18 AWG	DR2.5/5.ADO & DRE2.5/5.ADO		133
	1.5 mm ² / 16 AWG	DR4/6.ADO & DRE4/6.ADO		134
	2.5 mm ² / 14 AWG	DR4/8.ADO & DRE4/8.ADO		135
Ground	2.5 mm ² / 14 AWG	DR4/8.P.ADO		136
Base mounting				
Feed-through	1 mm ² / 18 AWG	DB2.5/5.ADO	With flanges mounting	137
	1.5 mm ² / 16 AWG	DB4/6.ADO	With flanges mounting	138
	2.5 mm ² / 14 AWG	DB4/8.ADO	With flanges mounting	139
	1.5 mm ² / 16 AWG	DH4/6.ADO	With snap in foot	140

ADO / ADO technology

Rail TH 35				
Feed-through	1.5 mm ² / 16 AWG	DS1.5/6.ADO & DSE1.5/6.ADO		141
	2.5 mm ² / 14 AWG	DS2.5/8.ADO & DSE2.5/8.ADO		142
Ground	2.5 mm ² / 14 AWG	DS2.5/8.P.ADO		143
Rail TH 15				
Feed-through	1 mm ² / 18 AWG	DR1/5.ADO & DRE1/5.ADO		144
	1.5 mm ² / 16 AWG	DR1.5/6.ADO & DRE1.5/6.ADO		145
	2.5 mm ² / 14 AWG	DR2.5/8.ADO & DRE2.5/8.ADO		146
Ground	2.5 mm ² / 14 AWG	DR2.5/8.P.ADO		147
Base mounting				
Feed-through	1.5 mm ² / 16 AWG	DB1.5/6.ADO	With flanges mounting	148
	2.5 mm ² / 14 AWG	DB2.5/8.ADO	With flanges mounting	149
	1.5 mm ² / 16 AWG	DH1.5/6.ADO	With snap in foot	150

6

15NC16009850201

Dedicated applications terminal blocks

Miniblocks

Screw clamp technology

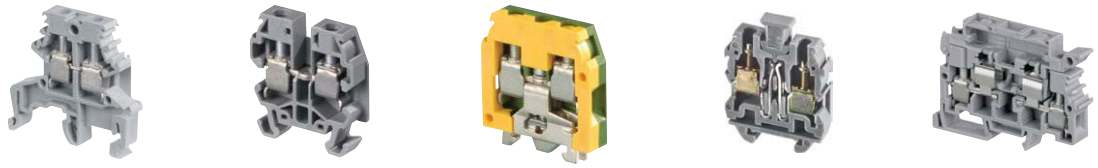

Section		Feed-through	Ground	Disconnect	Fuse
IEC	UL/CSA				
1.5 mm ²	12 AWG		DR1.5/4 4 mm 0.157 in		
1.5 mm ²	12 AWG		DR1.5/5 5 mm 0.197 in		
2.5 mm ²	12 AWG			DR2.5/5 S 5.08 mm 0.200 in	
4 mm ²	10-12 AWG	MS4/6 6 mm 0.236 in	DR4/6 6 mm 0.236 in	DR4/6.P 6 mm 0.236 in	DR4/8.SF 8 mm 0.315 in
6 mm ²	8 AWG	MS6/8 8 mm 0.315 in			
Rail / mounting		TH 35	TH 15	TH 15	TH 15

Spring clamp technology



Section		Feed-through				Ground
IEC	UL/CSA					
2.5 mm ²	12 AWG	DS2.5/5.2L 5 mm 0.197 in	DR2.5/5.2L 5 mm 0.197 in	DB2.5/5.2L 5 mm 0.197 in	DH2.5/5.2L 5 mm 0.197 in	
2.5 mm ²	12 AWG	DS2.5/10.4L 10 mm 0.394 in	DR2.5/10.4L 10 mm 0.394 in			DR2.5/10.P.4L 10 mm 0.394 in
Rail / mounting		TH 35	TH 15	BASE	BASE	TH 15



ADO / screw clamp technology



Feed-through

Ground

Section

IEC	UL/CSA						
1 mm ²	18 AWG	DS2.5/5.ADO 5 mm 0.197 in	DR2.5/5.ADO 5 mm 0.197 in	DB2.5/5.ADO 5 mm 0.197 in			
1.5 mm ²	16 AWG	DS4/6.ADO 6 mm 0.236 in	DR4/6.ADO 6 mm 0.236 in	DB4/6.ADO 6 mm 0.236 in	DH4/6.ADO 6 mm 0.236 in		
2.5 mm ²	14 AWG	DS4/8.ADO 8 mm 0.315 in	DR4/8.ADO 8 mm 0.315 in	DB4/8.ADO 8 mm 0.315 in		DS4/8.P.ADO 8 mm 0.315 in	DR4/8.P.ADO 8 mm 0.315 in
Rail / mounting		TH 35	TH 15	BASE	BASE	TH 35	TH 15



ADO / ADO technology



Feed-through

Ground

Section

IEC	UL/CSA						
1 mm ²	18 AWG		DR1/5.ADO 5 mm 0.197 in				
1.5 mm ²	16 AWG	DS1.5/6.ADO 6 mm 0.236 in	DR1.5/6.ADO 6 mm 0.236 in	DB1.5/6.ADO 6 mm 0.236 in	DH1.5/6.ADO 6 mm 0.236 in		
2.5 mm ²	14 AWG	DS2.5/8.ADO 8 mm 0.315 in	DR2.5/8.ADO 8 mm 0.315 in	DB2.5/8.ADO 8 mm 0.315 in		DS2.5/8.P.ADO 8 mm 0.315 in	DR2.5/8.P.ADO 8 mm 0.315 in
Rail / mounting		TH 35	TH 15	BASE	BASE	TH 35	TH 15

MS4/6 screw clamp terminal blocks

Miniblocks - 6 mm 0.236 in spacing

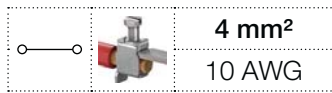

MS4/6

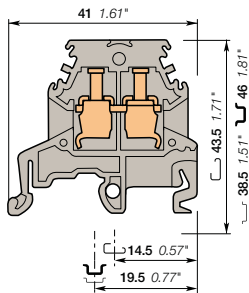

6 mm 0.236 in spacing

Description

- Save space with compact over-all dimensions terminal block,
- Flexibility: snap onto symmetrical and asymmetrical rails.

Ordering details

Description	Color	Type	Part Number	Pkg pce	Weight (1 pce) g
Miniblocks Feed-through	Grey <input type="checkbox"/>	MS4/6	1SNA115265R2400	100	6.00
	Yellow <input type="checkbox"/>	MS4/6	1SNA105265R0300	100	6.00

Main technical data

		IEC	UL	CSA	Mounting instructions	
1 conductor per clamp	Rigid: Solid/Stranded	0.2-4 mm²	22-10 AWG	22-12 AWG	Rail	G32, TH 35-7.5, TH 35-15
	Flexible without ferrule	0.22-4 mm²			Wire stripping length	10 mm 0.39 in
	Flexible with insulated ferrule				Tool	Flat screwdriver Ø 4 mm Ø 0.157 in
	Gauge	A4			Torque	0.5 - 0.8 Nm 4.4 - 7.1 lb.in
Rated current / Rated cross section		32 A / 4 mm²	30 A / 10 AWG	25 A / 12 AWG		
Rated short-time withstand current (1s)		480 A				
Rated voltage		630 V	600 V	300 V		
Impulse withstand voltage		4000 V				
Protection		IP20	NEMA 1			

The connecting capacity data for one Rigid: Solid/Stranded, or one Flexible conductor (when applicable) is a mandatory information required by IEC, UL and CSA standards (Copper conductors). All other data are provided as supplementary information only. For more details, please consult our CB, UL or CSA certificates and technical datasheet available on <http://www.TE.com>

--	--	--	--	--	--	--	--	--	--

Accessories

Description	Color	Type	Part Number	Pkg pce	Weight (1 pce) g	
1 End stops	Dark grey <input type="checkbox"/>	BAM4	1SNK900001R0000	50	14.00	
		BAZ1	1SNK900002R0000	50	5.30	
2 End sections	Grey <input type="checkbox"/>	FEMS6	1SNA113885R0100	20	1.80	
3 Lateral jumper bars	Grey <input type="checkbox"/>	2 poles	PC6-2	1SNA113546R1400	10	2.00
		3 poles	PC6-3	1SNA116536R0500	10	2.00
		4 poles	PC6-4	1SNA116537R0600	10	1.00
		10 poles	PC6-10	1SNA113548R2600	10	8.00
		4 Insulating tips		EIP	1SNA113550R2400	10
5 Circuit separators	Grey <input type="checkbox"/>	2.4 mm	SCFEX3	1SNA103620R0100	10	30.00
		3 mm	SCFCV1-2	1SNA116795R1100	10	8.00
6 Test adapters	Yellow <input type="checkbox"/>	DCJ	1SNA173059R0300	10	2.40	
7 Test plugs	Black <input type="checkbox"/>	FC2	1SNA007865R2600	100		
8 Protecting covers	Transparent <input type="checkbox"/>	CPV1-2	1SNA176816R1200	1		
9 Terminal block markers	White <input type="checkbox"/>	RC610	1SNA233000R0100	1	7.50	

Complete list of accessories is indicated in the terminal block datasheet. Some accessories such as jumper bars may modify the terminal block's ratings: complete information in the accessories catalogue pages.

Technical data valid for copper conductors only.

MS6/8 screw clamp terminal blocks

Miniblocks - 8 mm 0.315 in spacing

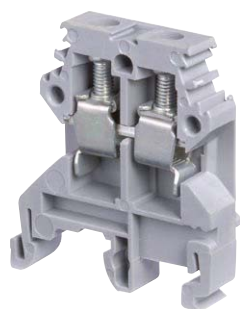

MS6/8

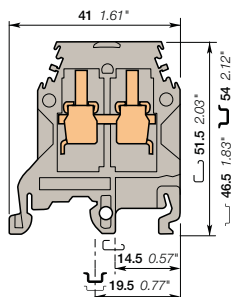

8 mm 0.315 in spacing

Description

- Save space with compact over-all dimensions terminal rail block,
- Flexibility: snap onto symmetrical and asymmetrical rails.

Ordering details

Description	Color	Type	Part Number	Pkg pce	Weight (1 pce) g
Miniblocks Feed-through	Grey <input type="checkbox"/>	MS6/8	1SNA115278R0100	50	12.00

Main technical data

		IEC	UL	CSA	Mounting instructions	
1 conductor per clamp	Rigid: Solid/Stranded	0.5-10 mm ²	22-8 AWG	20-8 AWG	Rail	G32, TH 35-7.5, TH 35-15
	Flexible without ferrule	0.5-6 mm ²			Wire stripping length	12 mm 0.47 in
	Flexible with insulated ferrule				Tool	Flat screwdriver Ø 4 - 5 mm Ø 0.157 - 0.197 in
Gauge		A5			Torque	0.8 - 1 Nm 7.1 - 8.9 lb.in
Rated current / Rated cross section		41 A / 6 mm ²	50 A / 8 AWG	40 A / 8 AWG		
Rated short-time withstand current (1s)		720 A				
Rated voltage		500 V	300 V	300 V		
Impulse withstand voltage		6000 V				
Protection		IP20	NEMA 1			

The connecting capacity data for one Rigid: Solid/Stranded, or one Flexible conductor (when applicable) is a mandatory information required by IEC, UL and CSA standards (Copper conductors). All other data are provided as supplementary information only. For more details, please consult our CB, UL or CSA certificates and technical datasheet available on <http://www.TE.com>

CE	RoHS	ULSR	CSA	Gost R				

Accessories

Description	Color	Type	Part Number	Pkg pce	Weight (1 pce) g	
1 End stops	Dark grey <input type="checkbox"/>	BAM4	1SNK900001R0000	50	14.00	
		BAZ1	1SNK900002R0000	50	5.30	
2 End sections	Grey <input type="checkbox"/>	FEMS8	1SNA114195R0600	25	1.90	
3 Lateral jumper bars	Grey <input type="checkbox"/>	2 poles	PC8-2	1SNA116538R1700	10	3.00
		3 poles	PC8-3	1SNA116539R1000	10	4.00
		4 poles	PC8-4	1SNA116540R2500	10	6.00
		10 poles	PC8-10	1SNA163313R2400	10	14.00
4 Circuit separators	Grey <input type="checkbox"/>	2.4 mm	SCFEX3	1SNA103620R0100	10	30.00
		3 mm	SCFCV1-2	1SNA116795R1100	10	8.00
5 Test adapters	Orange <input type="checkbox"/>	DCO	1SNA173060R0000	10	2.30	
6 Test plugs	Black <input type="checkbox"/>	FC2	1SNA007865R2600	100		
7 Protecting covers	Transparent <input type="checkbox"/>	CPV1-2	1SNA176816R1200	1		
8 Terminal block markers	Blank card			1		
	White <input type="checkbox"/>	RC810	1SNA234000R0200	1	8.20	

Complete list of accessories is indicated in the terminal block datasheet. Some accessories such as jumper bars may modify the terminal block's ratings: complete information in the accessories catalogue pages.

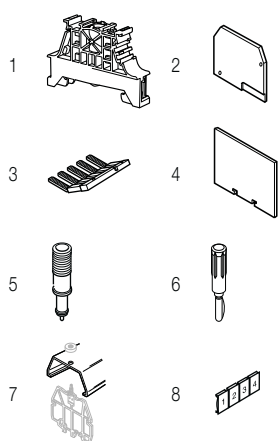

Technical data valid for copper conductors only.

DR1.5/4 screw clamp terminal blocks

Miniblocks - 4 mm 0.157 in spacing

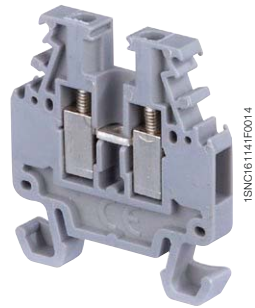

DR1.5/4

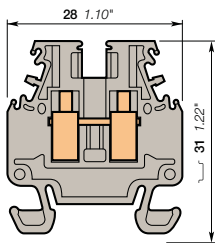

Description

Save space with compact over-all dimensions terminal block.

Ordering details

Description	Color	Type	Part Number	Pkg pce	Weight (1 pce) g
Miniblocks Feed-through	Grey <input type="checkbox"/>	DR1.5/4	1SNA110106R2500	50	3.00

Main technical data

		IEC	UL	CSA	Mounting instructions	
1 conductor per clamp	Rigid: Solid/Stranded	0.2-1.5 mm ²			Rail	TH 15-5.5
	Flexible without ferrule	0.22-1.5 mm ²			Wire stripping length	7 mm 0.275 in
	Flexible with insulated ferrule				Tool	Flat screwdriver Ø 2.5 mm Ø 0.98 in
	Gauge	A1			Torque	0.4 - 0.6 Nm 3.5 - 5.3 lb.in
Rated current / Rated cross section		17.5 A / 1.5 mm ²				
Rated short-time withstand current (1s)		180 A				
Rated voltage		500 V				
Impulse withstand voltage		6000 V				
Protection		IP20		NEMA 1		

The connecting capacity data for one Rigid: Solid/Stranded, or one Flexible conductor (when applicable) is a mandatory information required by IEC, UL and CSA standards (Copper conductors). All other data are provided as supplementary information only. For more details, please consult our CB, UL or CSA certificates and technical datasheet available on <http://www.TE.com>

--	--	--	--	--	--	--

4 mm 0.157 in spacing

Accessories

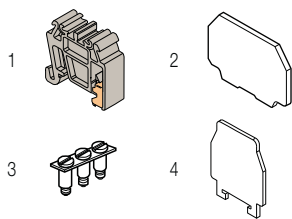

Description	Color	Type	Part Number	Pkg pce	Weight (1 pce) g
1 End stops 6.5 mm 0.256 in	Grey <input type="checkbox"/>	BADRL	1SNA199420R2100	50	2.00
2 End sections 1 mm 0.039 in	Grey <input type="checkbox"/>	FED2-4	1SNA215580R2100	25	1.40
3 Jumper bars 2 poles 17.5 A		BJM4	1SNA205735R0600	10	1.00
			1SNA205736R0700	10	2.00
			1SNA205737R0000	10	3.00
			1SNA205738R1100	10	6.00
4 Circuit separators 0.3 mm 0.012 in	White <input type="checkbox"/>	SCDR61	1SNA173016R1000	25	0.40
5 Terminal block markers Blank card	White <input type="checkbox"/>	RC410	1SNA229000R1500	1	5.16

Complete list of accessories is indicated in the terminal block datasheet.

Some accessories such as jumper bars may modify the terminal block's ratings: complete information in the accessories catalogue pages.

Technical data valid for copper conductors only.

DR1.5/5 screw clamp terminal blocks

Miniblocks - 5 mm 0.197 in spacing

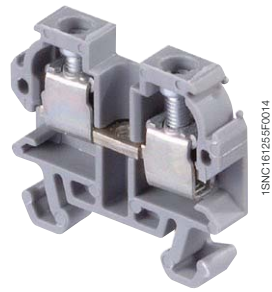

DR1.5/5

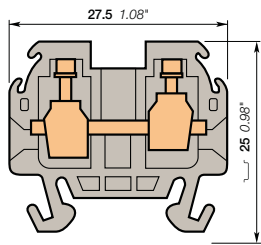

5 mm 0.197 in spacing

Description

Save space with compact over-all dimensions terminal block.

Ordering details

Description	Color	Type	Part Number	Pkg pce	Weight (1 pce) g
Miniblocks Feed-through	Grey <input type="checkbox"/>	DR1.5/5	1SNA115510R1600	100	5.00

Main technical data

		IEC	UL	CSA
1 conductor per clamp	Rigid: Solid/Stranded	0.2-2.5 mm ²	28 - 12 AWG	28 - 14 AWG
	Flexible without ferrule	0.22-1.5 mm ²		
	Flexible with insulated ferrule			
	Gauge			
Rated current / Rated cross section		20 A / 1.5 mm ²	20 A / 12 AWG	20 A / 14 AWG
Rated short-time withstand current (1s)		180 A		
Rated voltage		250 V	300 V	300 V
Impulse withstand voltage				
Protection		IP20	NEMA 1	

Mounting instructions

Rail		TH 15-5.5
Wire stripping length		8.5 mm 0.335 in
Tool		Flat screwdriver Ø 3.5 mm Ø 0.138 in
Torque		0.4 - 0.6 Nm 3.5 - 5.3 lb.in

The connecting capacity data for one Rigid: Solid/Stranded, or one Flexible conductor (when applicable) is a mandatory information required by IEC, UL and CSA standards (Copper conductors). All other data are provided as supplementary information only. For more details, please consult our CB, UL or CSA certificates and technical datasheet available on <http://www.TE.com>

CE	RoHS	UR	CSA	Gost R

Accessories

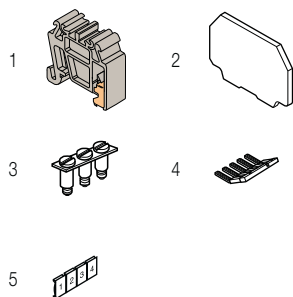

Description	Color	Type	Part Number	Pkg pce	Weight (1 pce) g
1 End stops 6.5 mm 0.256 in	Grey <input type="checkbox"/>	BADRL	1SNA199420R2100	50	2.00
2 End sections 1 mm 0.039 in	Grey <input type="checkbox"/>	FEDR5	1SNA117318R2300	25	0.80
3 Jumper bars 2 poles 24 A		BJMI5DR	1SNA176704R0200	10	2.00
			3 poles	10	3.00
			4 poles	10	4.00
			10 poles	10	12.00
4 Lateral jumper bars 10 poles 25 A		PC51-10	1SNA167908R0600	10	5.00
5 Terminal block markers Blank card	White <input type="checkbox"/>	RC55	1SNA230000R1200	1	2.90

Complete list of accessories is indicated in the terminal block datasheet.

Some accessories such as jumper bars may modify the terminal block's ratings: complete information in the accessories catalogue pages.

Technical data valid for copper conductors only.

DR1.5/5 screw clamp terminal blocks

Miniblocks - 5 mm 0.197 in spacing



DR1.5/5

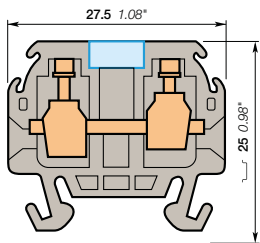

Description

Save space with compact over-all dimensions terminal block.

Ordering details

Description	Color	Type	Part Number	Pkg pce	Weight (1 pce) g
Miniblocks Feed-through with partition	Grey <input type="checkbox"/>	DR1.5/5.1	1SNA112086R0200	100	5.00

Main technical data

		IEC	UL	CSA	Mounting instructions	
1 conductor per clamp	Rigid: Solid/Stranded	0.2-2.5 mm ²		28-14 AWG	Rail	TH 15-5.5
	Flexible without ferrule	0.22-1.5 mm ²			Wire stripping length	8.5 mm 0.335 in
	Flexible with insulated ferrule				Tool	Flat screwdriver Ø 3.5 mm Ø 0.138 in
	Gauge				Torque	0.4 - 0.6 Nm 3.5 - 5.3 lb.in
Rated current / Rated cross section		20 A / 1.5 mm ²		20 A / 14 AWG		
Rated short-time withstand current (1s)		180 A				
Rated voltage		250 V		300 V		
Impulse withstand voltage						
Protection		IP20	NEMA 1			

The connecting capacity data for one Rigid: Solid/Stranded, or one Flexible conductor (when applicable) is a mandatory information required by IEC, UL and CSA standards (Copper conductors). All other data are provided as supplementary information only. For more details, please consult our CB, UL or CSA certificates and technical datasheet available on <http://www.TE.com>

CE	RoHS	CSA	Gost R				
----	------	-----	--------	--	--	--	--

5 mm 0.197 in spacing

Accessories

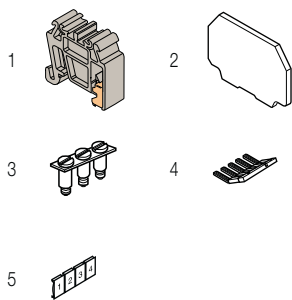

Description	Color	Type	Part Number	Pkg pce	Weight (1 pce) g	
1 End stops 6.5 mm 0.256 in	Grey <input type="checkbox"/>	BADRL	1SNA199420R2100	50	2.00	
2 End sections 1 mm 0.039 in	Grey <input type="checkbox"/>	FEDR5	1SNA117318R2300	25	0.80	
3 Jumper bars		BJMI5DR	2 poles 24 A	1SNA176704R0200	10	2.00
			3 poles	1SNA176705R0300	10	3.00
			4 poles	1SNA176706R0400	10	4.00
			10 poles	1SNA176708R1600	10	12.00
			20 poles	1SNA177652R0600	10	4.00
4 Lateral jumper bars 10 poles 25 A		BJS5-20	1SNA177652R0600	10	4.00	
4 Lateral jumper bars 10 poles 25 A		PC51-10	1SNA167908R0600	10	5.00	
5 Terminal block markers Blank card	White <input type="checkbox"/>	RC55	1SNA230000R1200	1	2.90	

Complete list of accessories is indicated in the terminal block datasheet.

Some accessories such as jumper bars may modify the terminal block's ratings: complete information in the accessories catalogue pages.

Technical data valid for copper conductors only.

DR4/6 screw clamp terminal blocks

Miniblocks - 6 mm 0.236 in spacing

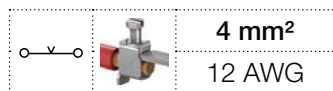

DR4/6

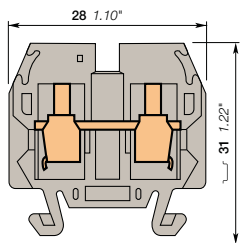

6 mm 0.236 in spacing

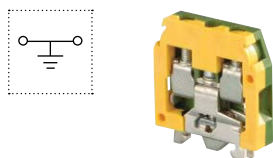
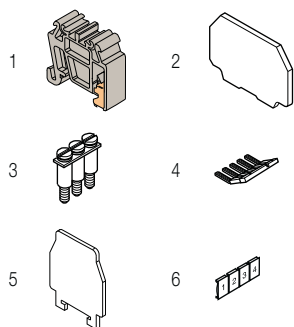

Description

Save space with compact over-all dimensions terminal block.

Ordering details

Description	Color	Type	Part Number	Pkg pce	Weight (1 pce) g
Miniblocks Feed-through	Grey <input type="checkbox"/>	DR4/6	1SNA110251R0500	50	6.00
	Blue <input type="checkbox"/>	DR4/6.N	1SNA120251R0700	50	6.00

Main technical data

		IEC	UL	CSA	Mounting instructions	
					Rail	TH 15-5.5
1 conductor per clamp	Rigid: Solid/Stranded	0.2-4 mm²	22 - 12 AWG	28-10 AWG	Wire stripping length	9.5 mm 0.37 in
	Flexible without ferrule	0.22-4 mm²				
	Flexible with insulated ferrule				Tool	Flat screwdriver Ø 4 mm Ø 0.157 in
	Gauge				Torque	0.5 - 0.8 Nm 4.4 - 7.1 lb.in
Rated current / Rated cross section	30 A / 4 mm²	20 A / 12 AWG	25 A / 10 AWG			
Rated short-time withstand current (1s)	480 A					
Rated voltage	500 V	250 V	600 V			
Impulse withstand voltage						
Protection		IP20	NEMA 1			

The connecting capacity data for one Rigid: Solid/Stranded, or one Flexible conductor (when applicable) is a mandatory information required by IEC, UL and CSA standards (Copper conductors). All other data are provided as supplementary information only. For more details, please consult our CB, UL or CSA certificates and technical datasheet available on <http://www.TE.com>

--	--	--	--	--	--	--	--	--	--	--	--	--	--	--	--	--	--	--	--	--

Accessories

Description	Color	Type	Part Number	Pkg pce	Weight (1 pce) g	
1 End stops 6.5 mm 0.256 in	Grey <input type="checkbox"/>	BADRL	1SNA199420R2100	50	2.00	
2 End sections 1 mm 0.039 in	Grey <input type="checkbox"/>	FEDR61	1SNA117600R0300	25	0.80	
3 Jumper bars		2 poles 32 A	BJM62	1SNA173217R2600	10	2.00
		3 poles		1SNA173218R0700	10	3.00
		4 poles		1SNA173219R0000	10	4.00
		10 poles		1SNA173226R2700	10	10.00
4 Lateral jumper bars 10 poles 35 A		PC61-10	1SNA163311R2200	10	5.00	
5 Circuit separators 0.3 mm 0.012 in	White <input type="checkbox"/>	SCDR61	1SNA173016R1000	25	0.40	
6 Terminal block markers Blank card	White <input type="checkbox"/>	RC65	1SNA232000R0000	1	3.60	

Complete list of accessories is indicated in the terminal block datasheet. Some accessories such as jumper bars may modify the terminal block's ratings: complete information in the accessories catalogue pages.

Ground screw clamp terminal blocks

Description	Color	Type	Part Number	Pkg pce	Weight (1 pce) g
Ground Profile aligned with DR4/6...	Green-yellow <input type="checkbox"/>	DR4/6.P	1SNA160496R2600	50	10.00

Technical data valid for copper conductors only.

DR4/6.1 screw clamp terminal blocks

Miniblocks - 6 mm 0.236 in spacing

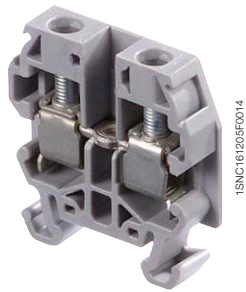
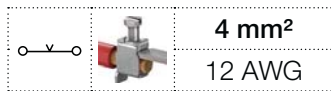

DR4/6.1

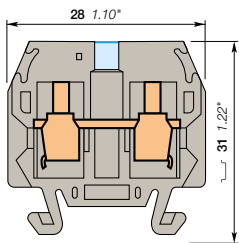

Description

Save space with compact over-all dimensions terminal block.

Ordering details

Description	Color	Type	Part Number	Pkg pce	Weight (1 pce) g
Miniblocks Feed-through with partition	Grey <input type="checkbox"/>	DR4/6.1	1SNA110491R1700	50	6.00
Feed-through	Blue <input type="checkbox"/>	DR4/6.1.N	1SNA120491R1100	50	6.00

Main technical data

	IEC	UL	CSA
1 conductor per clamp	Rigid: Solid/Stranded Flexible without ferrule Flexible with insulated ferrule Gauge	0.2-4 mm ² 0.22-4 mm ²	28-10 AWG
Rated current / Rated cross section	30 A / 4 mm ²		25 A / 10 AWG
Rated short-time withstand current (1s)	480 A		
Rated voltage	500 V		600 V
Impulse withstand voltage			
Protection	IP20	NEMA 1	

Mounting instructions

	Rail	TH 15-5.5
Wire stripping length		9.5 mm 0.37 in
Tool		Flat screwdriver Ø 4 mm Ø 0.157 in
Torque		0.5 - 0.8 Nm 4.4 - 7.1 lb.in

The connecting capacity data for one Rigid: Solid/Stranded, or one Flexible conductor (when applicable) is a mandatory information required by IEC, UL and CSA standards (Copper conductors). All other data are provided as supplementary information only. For more details, please consult our CB, UL or CSA certificates and technical datasheet available on <http://www.TE.com>

--	--	--	--	--	--	--	--	--	--

6 mm 0.236 in spacing

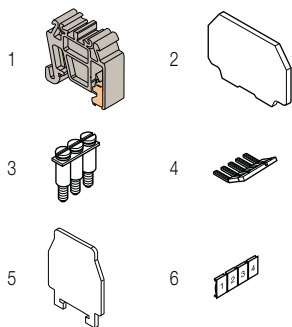

Accessories

Description	Color	Type	Part Number	Pkg pce	Weight (1 pce) g
1 End stops 6.5 mm 0.256 in	Grey <input type="checkbox"/>	BADRL	1SNA199420R2100	50	2.00
2 End sections 1 mm 0.039 in	Grey <input type="checkbox"/>	FEDR61	1SNA117600R0300	25	0.80
3 Jumper bars 2 poles 32 A		BJM62	1SNA173217R2600	10	2.00
3 poles			1SNA173218R0700	10	3.00
4 poles			1SNA173219R0000	10	4.00
10 poles			1SNA173226R2700	10	10.00
4 Lateral jumper bars 10 poles 35 A		PC61-10	1SNA163311R2200	10	5.00
5 Circuit separators 0.3 mm 0.012 in	White <input type="checkbox"/>	SCDR61	1SNA173016R1000	25	0.40
6 Terminal block markers Blank card	White <input type="checkbox"/>	RC65	1SNA232000R0000	1	3.60

Complete list of accessories is indicated in the terminal block datasheet.

Some accessories such as jumper bars may modify the terminal block's ratings: complete information in the accessories catalogue pages.

Ground screw clamp terminal blocks

Description	Color	Type	Part Number	Pkg pce	Weight (1 pce) g
Ground Profile aligned with DR4/6...	Green-yellow <input type="checkbox"/>	DR4/6.P	1SNA160496R2600	50	10.00

Technical data valid for copper conductors only.

DR4/6.P screw clamp terminal blocks

Miniblocks - 6 mm 0.236 in spacing

		4 mm²
		12 AWG

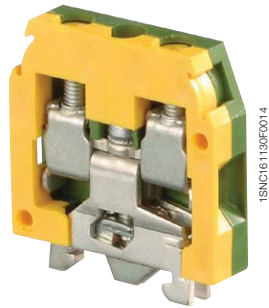

DR4/6.P

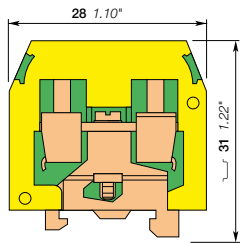

Description

- Save space with compact over-all dimensions terminal block,
- For DIN 2 rail,
- Reliable electrical and mechanical contact with the rail.

Ordering details

Description	Color	Type	Part Number	Pkg pce	Weight (1 pce) g
Ground Screwless rail connection	Green-yellow	DR4/6.P	1SNA160496R2600	50	10.00

Main technical data

		IEC	UL	CSA	Mounting instructions	
1 conductor per clamp	Rigid: Solid/Stranded	0.2-4 mm ²	22-12 AWG	28-10 AWG	Wire stripping length	9.5 mm / 0.37 in
	Flexible without ferrule	0.22-4 mm ²			Screw clamp Tool	Flat screwdriver Ø 4 mm Ø 0.157 in
	Flexible with insulated ferrule Gauge					
Rated cross section		4 mm ²	12 AWG	10 AWG	Torque	0.5 - 0.8 N.m / 4.4 - 7.1 lb.in
Rated short-time withstand current (1s)		480 A				

The connecting capacity data for one Rigid: Solid/Stranded, or one Flexible conductor (when apply) is a mandatory information required by IEC, UL and CSA standards (Copper conductors). All other data are provided as supplementary information only. For more details, please consult our CB, UL or CSA certificates and technical datasheet available on <http://www.TE.com>

--	--	--	--	--	--	--	--	--	--	--

6 mm 0.236 in spacing

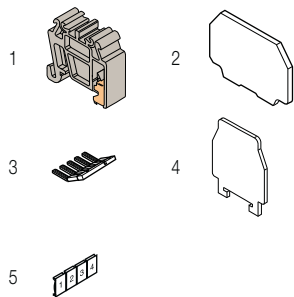

Accessories

Description	Color	Type	Part Number	Pkg pce	Weight (1 pce) g
1 End stops 6.5 mm 0.256 in	Grey <input type="checkbox"/>	BADRL	1SNA199420R2100	50	2.00
2 End sections 1 mm 0.039 in	Grey <input type="checkbox"/>	FEDR61	1SNA117600R0300	25	0.80
3 Lateral jumper bars 10 poles 35 A		PC61-10	1SNA163311R2200	10	5.00
4 Circuit separators 0.3 mm 0.012 in	White <input type="checkbox"/>	SCDR61	1SNA173016R1000	25	0.40
5 Terminal block markers Blank card	White <input type="checkbox"/>	RC65	1SNA232000R0000	1	3.60

Complete list of accessories is indicated in the terminal block datasheet. Some accessories such as jumper bars may modify the terminal block's ratings: complete information in the accessories catalogue pages.

Technical data valid for copper conductors only.

DR2.5/5.S screw clamp terminal blocks

Miniblocks - 5.08 mm 0.200 in spacing



DR2.5/5.S

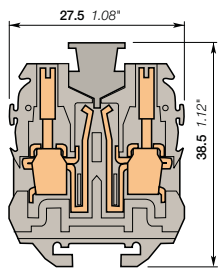

5.08 mm 0.200 in spacing

Description

- Save space with compact over-all dimensions terminal block,
- Ease your disconnect operations with the disconnect plug.

Ordering details

Description	Color	Type	Part Number	Pkg pce	Weight (1 pce) g
Miniblocks Disconnect with 2 test sockets DIA 2 mm 0.079 in	Grey <input type="checkbox"/>	DR2.5/5.S1	1SNA112098R1600	100	6.00

Main technical data

		IEC	UL	CSA	Mounting instructions	
1 conductor per clamp	Rigid: Solid/Stranded	0.5-4 mm ²			Rail	TH 15-5.5
	Flexible without ferrule	0.5-2.5 mm ²			Wire stripping length	8.5 mm 0.335 in
	Flexible with insulated ferrule				Tool	Flat screwdriver Ø 3.5 mm Ø 0.138 in
	Gauge				Torque	0.4 - 0.6 Nm 3.5 - 5.3 lb.in
Rated current / Rated cross section		3 A / 2.5 mm ²				
Rated short-time withstand current (1s)		300 A				
Rated voltage		380 V				
Pulse withstand voltage						
Protection		IP20	NEMA 1			

The connecting capacity data for one Rigid: Solid/Stranded, or one Flexible conductor (when applicable) is a mandatory information required by IEC, UL and CSA standards (Copper conductors). All other data are provided as supplementary information only. For more details, please consult our CB, UL or CSA certificates and technical datasheet available on <http://www.TE.com>

CE	RoHS	Gost R				
----	------	--------	--	--	--	--

Accessories

Description	Color	Type	Part Number	Pkg pce	Weight (1 pce) g
1 End stops 6.5 mm 0.256 in	Grey <input type="checkbox"/>	BADRL	1SNA199420R2100	50	2.00
2 End sections 1 mm 0.039 in	Grey <input type="checkbox"/>	FEDR51	1SNA117668R0200	25	1.00
3 Shield connectors		CBD5	1SNA167674R0200	25	
4 Terminal block markers Blank card	White <input type="checkbox"/>	RC55	1SNA230000R1200	1	2.90

Complete list of accessories is indicated in the terminal block datasheet. Some accessories such as jumper bars may modify the terminal block's ratings: complete information in the accessories catalogue pages.

Technical data valid for copper conductors only.

DR4/8.SF screw clamp terminal blocks

Miniblocks - 8 mm 0.315 in spacing

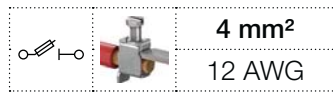

4 mm²
12 AWG

Description

- Save space with compact over-all dimensions terminal block,
- Protect your circuits with 5x20 and 5x25 fuse terminal blocks (fuse not supplied with terminal blocks).

Ordering details

Description	Color	Type	Part Number	Pkg pce	Weight (1 pce) g
Miniblocks Fuse	Grey <input type="checkbox"/>	DR4/8.SF	1SNA110368R1200	50	14.00

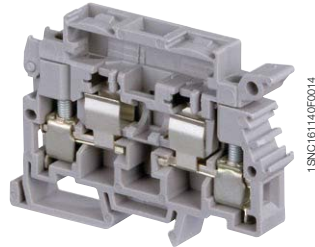

DR4/8.SF

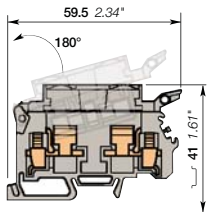

Main technical data

	IEC	UL	CSA
1 conductor per clamp			
Rigid: Solid/Stranded	0.5-4 mm ²		18 - 12 AWG
Flexible without ferrule	0.5-4 mm ²		
Flexible with insulated ferrule			
Gauge	A4		
Rated current / Rated cross section	6.3 A / 4 mm ²		6.3 A / 12 AWG
Rated short-time withstand current (1s)	480 A		
Rated voltage	630 V		300 V
Impulse withstand voltage	8000 V		
Protection	IP20	NEMA 1	

Mounting instructions

Rail		TH 15-5.5
Wire stripping length		9.5 mm 0.37 in
Tool		Flat screwdriver Ø 4 mm Ø 0.157 in
Torque		0.5 - 0.8 Nm 4.4 - 7.1 lb.in

The connecting capacity data for one Rigid: Solid/Stranded, or one Flexible conductor (when applicable) is a mandatory information required by IEC, UL and CSA standards (Copper conductors). All other data are provided as supplementary information only. For more details, please consult our CB, UL or CSA certificates and technical datasheet available on <http://www.TE.com>

CE	RoHS	CSA	Gost R

8 mm 0.315 in spacing

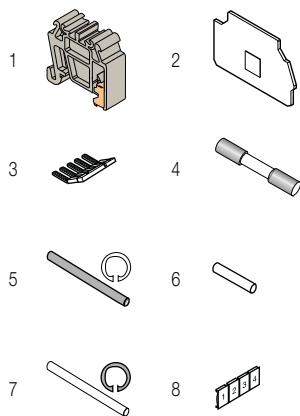

Accessories

Description	Color	Type	Part Number	Pkg pce	Weight (1 pce) g
1 End stops	Grey <input type="checkbox"/>	BADRL	1SNA199420R2100	50	2.00
2 End sections	Grey <input type="checkbox"/>	FEM8S	1SNA116951R1500	20	2.60
3 Lateral jumper bars		PC81-10	1SNA173523R1100	10	5.00
4 Fuses		FU520	1SNA008288R1500	10	
			1SNA008289R1600	10	
			1SNA008290R1300	10	
			1SNA008291R0000	10	
			1SNA008292R0100	10	
5 Assembly rods		TGA8	1SNA168672R1100	10	1.00
			1SNA168673R1200	10	
			1SNA168674R1300	10	
6 Neutral cartridges		CN5	1SNA179371R1600	10	3.90
7 Spring retaining rings		ANT	1SNA168675R1400	10	
8 Terminal block markers	White <input type="checkbox"/>	RC810	1SNA234000R0200	1	8.20

Complete list of accessories is indicated in the terminal block datasheet. Some accessories such as jumper bars may modify the terminal block's ratings: complete information in the accessories catalogue pages.

Technical data valid for copper conductors only.

DS2.5/5.2L spring terminal blocks

Miniblocks - 5 mm 0.197 in spacing



DS2.5/5.2L

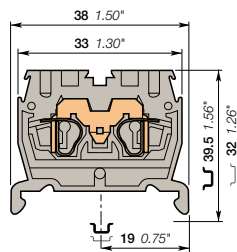

Description

- Save space with compact terminal blocks,
- Easy mounting on DIN rail TH35,
- Easy to access thanks to the front wiring entry,
- Clamping contact pressure non dependent on the operator and automatic creeping compensation.

Ordering details

Description	Color	Type	Part Number	Pkg pce	Weight (1 pce) g
Feed-through 2 connections	Grey	DS2.5/5.2L	1SNA290221R0400	100	4.00
	Blue	DS2.5/5.N.2L	1SNA290223R0600	100	4.00

Main technical data

		IEC	UL	CSA
1 conductor per clamp	Rigid: Solid/Stranded	0.12-4 mm ²	26-12 AWG	
	Flexible without ferrule	0.12-2.5 mm ²		
	Flexible with non insulated ferrule			
	Flexible with insulated ferrule	0.5-1.5 mm ²		
Gauge		A2		
Rated current / Rated cross section		24 A / 2.5 mm ²	15 A / 12 AWG	
Rated short-time withstand current (1s)		300 A		
Rated voltage		800 V	600 V	
Impulse withstand voltage		8000 V		
Protection		IP20	NEMA 1	

Mounting instructions

Rail		TH 35-7.5, TH 35-15
Wire stripping length		9.5 mm 0.37 in
Tool		Flat screwdriver Ø 3.5 mm Ø 0.138 in

The connecting capacity data for one Rigid: Solid/Stranded, or one Flexible conductor (when applicable) is a mandatory information required by IEC, UL and CSA standards (Copper conductors). All other data are provided as supplementary information only. For more details, please consult our CB, UL or CSA certificates and technical datasheet available on <http://www.TE.com>



Notes

5 mm 0.197 in spacing

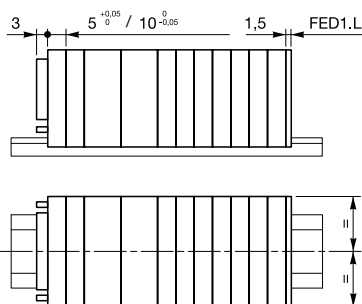

Accessories

Description	Color	Type	Part Number	Pkg pce	Weight (1 pce) g
1 End stops	Dark grey	BZ1	1SNK900002R0000	50	5.30
		BAM4	1SNK900001R0000	50	14.00
2 End sections	Grey	FED1.L	1SNA291301R0200	20	1.40
		FED2.L	1SNA291311R2300	20	1.90
3 Jumper bars	Orange	2 poles	BIDL5-2	50	1.00
		3 poles	BIDL5-3	50	0.70
		4 poles	BIDL5-4	50	0.80
		5 poles	BIDL5-5	20	0.90
		10 poles	BIDL5-10	20	1.20
4 Terminal block markers	White	Blank card	RC55	1	2.90

Complete list of accessories is indicated in the terminal block datasheet. Some accessories such as jumper bars may modify the terminal block's ratings: complete information in the accessories catalogue pages.

Technical data valid for copper conductors only.

DS2.5/10.4L spring terminal blocks

Miniblocks - 10 mm 0.394 in spacing



DS2.5/10.4L

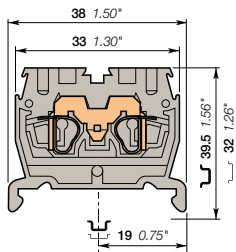

10 mm 0.394 in spacing

Description

- Save space with compact terminal blocks,
- Easy mounting on DIN rail TH35,
- Easy to access thanks to the front wiring entry,
- Clamping contact pressure non dependent on the operator and automatic creeping compensation.

Ordering details

Description	Color	Type	Part Number	Pkg pce	Weight (1 pce) g
Feed-through 4 connections	Grey	DS2.5/10.4L	1SNA290231R0600	100	6.00
	Blue	DS2.5/10.N.4L	1SNA290233R0000	100	6.00
	Yellow	DS2.5/10.4L.YL	1SNA290501R0000	100	6.00

Main technical data

		IEC	UL	CSA	Mounting instructions	
1 conductor per clamp	Rigid: Solid/Stranded	0.12-4 mm ²	26-12 AWG		Rail	TH 35-7.5, TH 35-15
	Flexible without ferrule	0.12-2.5 mm ²			Wire stripping length	9.5 mm 0.37 in
	Flexible with non insulated ferrule				Tool	Flat screwdriver Ø 3.5 mm Ø 0.138 in
	Flexible with insulated ferrule	0.5-1.5 mm ²				
Gauge	A2					
Rated current / Rated cross section		24 A / 2.5 mm ²	15 A / 12 AWG			
Rated short-time withstand current (1s)		300 A				
Rated voltage		800 V	600 V			
Impulse withstand voltage		8000 V				
Protection		IP20	NEMA 1			

The connecting capacity data for one Rigid: Solid/Stranded, or one Flexible conductor (when applicable) is a mandatory information required by IEC, UL and CSA standards (Copper conductors). All other data are provided as supplementary information only. For more details, please consult our CB, UL or CSA certificates and technical datasheet available on <http://www.TE.com>



Notes

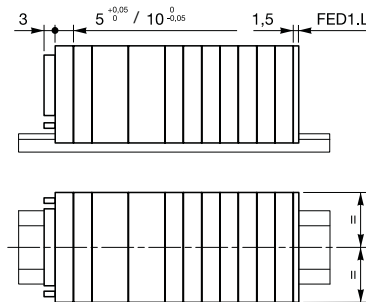

Accessories

Description	Color	Type	Part Number	Pkg pce	Weight (1 pce) g
1 End stops	Dark grey	BAZ1	1SNK900002R0000	50	5.30
		BAM4	1SNK900001R0000	50	14.00
2 End sections	Grey	FED1.L	1SNA291301R0200	20	1.40
		FED2.L	1SNA291311R2300	20	1.90
3 Jumper bars	Orange	2 poles	BJDL10-2	50	1.00
		3 poles	BJDL10-3	50	1.00
		4 poles	BJDL10-4	20	2.00
		5 poles	BJDL10-5	20	2.00
4 Terminal block markers Blank card	White	RC55	1SNA230000R1200	1	2.90

Complete list of accessories is indicated in the terminal block datasheet. Some accessories such as jumper bars may modify the terminal block's ratings: complete information in the accessories catalogue pages.

Technical data valid for copper conductors only.

DR2.5/5.2L spring terminal blocks

Miniblocks - 5 mm 0.197 in spacing



1SNC16209S0014

DR2.5/5.2L

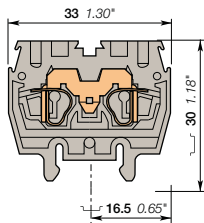

Description

- Save space with compact terminal blocks,
- Easy mounting on DIN rail TH15,
- Easy to access thanks to the front wiring entry,
- Clamping contact pressure non dependent on the operator and automatic creeping compensation.

Ordering details

Description	Color	Type	Part Number	Pkg pce	Weight (1 pce) g
Feed-through 2 connections	Grey <input type="checkbox"/>	DR2.5/5.2L	1SNA290201R1100	100	4.00
	Blue <input type="checkbox"/>	DR2.5/5.N.2L	1SNA290203R1300	100	4.00

Main technical data

	IEC	UL	CSA
1 conductor per clamp			
Rigid: Solid/Stranded	0.12-4 mm ²	26-12 AWG	
Flexible without ferrule	0.12-2.5 mm ²		
Flexible with non insulated ferrule			
Flexible with insulated ferrule	0.5-1.5 mm ²		
Gauge	A2		
Rated current / Rated cross section	24 A / 2.5 mm ²	15 A / 12 AWG	
Rated short-time withstand current (1s)	300 A		
Rated voltage	800 V	600 V	
Impulse withstand voltage	8000 V		
Protection	IP20	NEMA 1	

Mounting instructions

	Rail	TH 15-5.5
Wire stripping length		9.5 mm 0.37 in
Tool		Flat screwdriver Ø 3.5 mm Ø 0.138 in

The connecting capacity data for one Rigid: Solid/Stranded, or one Flexible conductor (when applicable) is a mandatory information required by IEC, UL and CSA standards (Copper conductors). All other data are provided as supplementary information only. For more details, please consult our CB, UL or CSA certificates and technical datasheet available on <http://www.TE.com>

RoHS <input type="checkbox"/>		
RoHS	UL	Gost R

5 mm 0.197 in spacing

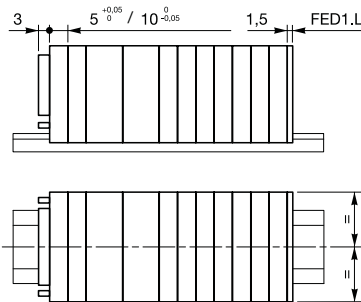

Accessories

Description	Color	Type	Part Number	Pkg pce	Weight (1 pce) g
1 End stops 6.5 mm 0.256 in	Grey <input type="checkbox"/>	BADRL	1SNA199420R2100	50	2.00
2 End sections 1.5 mm 0.059 in	Grey <input type="checkbox"/>	FED1.L	1SNA291301R0200	20	1.40
3 Jumper bars 4 mm 0.157 in	Orange <input type="checkbox"/>	FED2.L	1SNA291311R2300	20	1.90
		BJDL5-2	1SNA291102R2300	50	1.00
		BJDL5-3	1SNA291103R2400	50	0.70
		BJDL5-4	1SNA291104R2500	50	0.80
		BJDL5-5	1SNA291105R2600	20	0.90
BJDL5-10	1SNA291110R2600	20	1.20		
4 Terminal block markers Blank card	White <input type="checkbox"/>	RC55	1SNA230000R1200	1	2.90

Complete list of accessories is indicated in the terminal block datasheet. Some accessories such as jumper bars may modify the terminal block's ratings: complete information in the accessories catalogue pages.

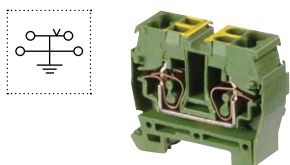

Ground spring terminal blocks

Description	Color	Type	Part Number	Pkg pce	Weight (1 pce) g
Ground Profile aligned with DR2.5/...L	Green-yellow <input type="checkbox"/>	DR2.5/10.P.4L	1SNA290219R1200	100	7.00

Technical data valid for copper conductors only.

DR2.5/10.4L spring terminal blocks

Miniblocks - 10 mm 0.394 in spacing

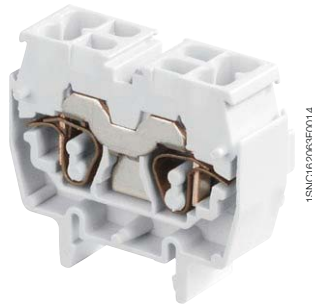

DR2.5/10.4L

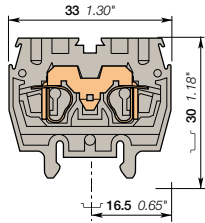

10 mm 0.394 in spacing

Description

- Save space with compact terminal blocks,
- Easy mounting on DIN rail TH15,
- Easy to access thanks to the front wiring entry,
- Clamping contact pressure non dependent on the operator and automatic creeping compensation.

Ordering details

Description	Color	Type	Part Number	Pkg pce	Weight (1 pce) g
Feed-through 4 connections	Grey <input type="checkbox"/>	DR2.5/10.4L	1SNA290211R0200	100	6.00
	Blue <input type="checkbox"/>	DR2.5/10.N.4L	1SNA290213R0400	100	6.00

Main technical data

		IEC	UL	CSA	Mounting instructions	
1 conductor per clamp	Rigid: Solid/Stranded	0.12-4 mm ²	26-12 AWG		Rail	TH 15-5.5
	Flexible without ferrule	0.12-2.5 mm ²			Wire stripping length	9.5 mm 0.37 in
	Flexible with non insulated ferrule				Tool	Flat screwdriver Ø 3.5 mm Ø 0.138 in
	Flexible with insulated ferrule	0.5-1.5 mm ²				
Gauge		A2				
Rated current / Rated cross section		24 A / 2.5 mm ²	15 A / 12 AWG			
Rated short-time withstand current (1s)		300 A				
Rated voltage		800 V	600 V			
Impulse withstand voltage		8000 V				
Protection		IP20	NEMA 1			

The connecting capacity data for one Rigid: Solid/Stranded, or one Flexible conductor (when applicable) is a mandatory information required by IEC, UL and CSA standards (Copper conductors). All other data are provided as supplementary information only. For more details, please consult our CB, UL or CSA certificates and technical datasheet available on <http://www.TE.com>

RoHS	UL	PC	Gost R
RoHS	UL CNR		

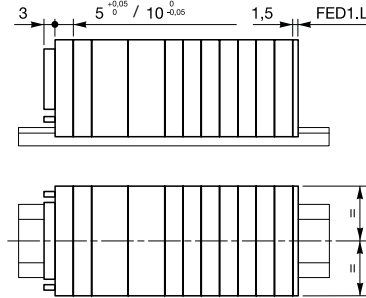

Accessories

Description	Color	Type	Part Number	Pkg pce	Weight (1 pce) g	
1 End stops	Grey <input type="checkbox"/>	BADRL	1SNA199420R2100	50	2.00	
2 End sections	Grey <input type="checkbox"/>	FED1.L	1SNA291301R0200	20	1.40	
		FED2.L	1SNA291311R2300	20	1.90	
3 Jumper bars	Orange <input type="checkbox"/>	2 poles	BJDL10-2	1SNA291322R2600	50	1.00
		3 poles	BJDL10-3	1SNA291323R2700	50	1.00
		4 poles	BJDL10-4	1SNA291324R2000	20	2.00
		5 poles	BJDL10-5	1SNA291325R2100	20	2.00
		4 Terminal block markers	White <input type="checkbox"/>	RC55	1SNA230000R1200	1

Complete list of accessories is indicated in the terminal block datasheet.

Some accessories such as jumper bars may modify the terminal block's ratings: complete information in the accessories catalogue pages.

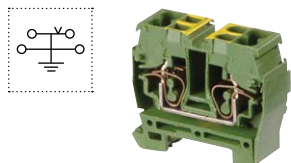

Ground spring terminal blocks

Description	Color	Type	Part Number	Pkg pce	Weight (1 pce) g
Ground	Green-yellow <input type="checkbox"/>	DR2.5/10.P.4L	1SNA290219R1200	100	7.00

Technical data valid for copper conductors only.

DR2.5/10.P.4L spring terminal blocks

Miniblocks - 10 mm 0.394 in spacing



2.5 mm²

12 AWG

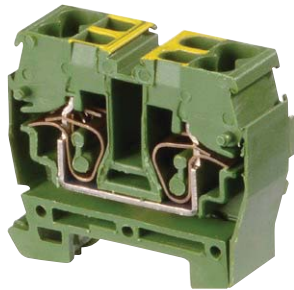

1SNC162071F0014

DR2.5/10.P.4L

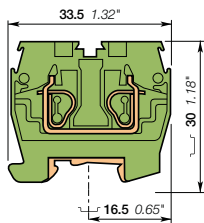

10 mm 0.394 in spacing

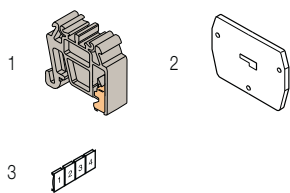

Description

- Save space with compact terminal blocks,
- Easy mounting on DIN rail TH15,
- Easy to access thanks to the front wiring entry,
- Clamping contact pressure non dependent on the operator and automatic creeping compensation.

Ordering details

Description	Color	Type	Part Number	Pkg pce	Weight (1 pce) g
Ground Screwless rail connection	Green-yellow	DR2.5/10.P.4L	1SNA290219R1200	100	7.00

Main technical data

		IEC	UL	CSA	Mounting instructions	
					Rail	TH 15-5.5
1 conductor per clamp	Rigid: Solid/Stranded	0.12-4 mm ²			Wire stripping length	9.5 mm 0.37 in
	Flexible without ferrule	0.12-2.5 mm ²				
	Flexible with non insulated ferrule				Tool	Flat screwdriver Ø 3.5 mm Ø 0.138 in
	Flexible with insulated ferrule	0.5-1.5 mm ²				
Gauge		A2				
Rated cross section		2.5 mm ²				
Rated short-time withstand current (1s)		300 A				
Protection		IP20	NEMA 1			

The connecting capacity data for one Rigid: Solid/Stranded, or one Flexible conductor (when applicable) is a mandatory information required by IEC, UL and CSA standards (Copper conductors). All other data are provided as supplementary information only. For more details, please consult our CB, UL or CSA certificates and technical datasheet available on <http://www.TE.com>

RoHS	Gost R
------	--------

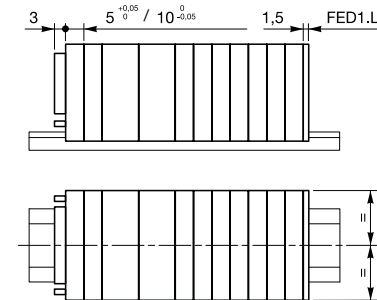

Accessories

Description	Color	Type	Part Number	Pkg pce	Weight (1 pce) g
1 End stops 6.5 mm 0.256 in	Grey	BADRL	1SNA199420R2100	50	2.00
2 End sections 1.5 mm 0.059 in	Grey	FED1.L	1SNA291301R0200	20	1.40
3 Terminal block markers Blank card	White	RC55	1SNA230000R1200	1	2.90

Complete list of accessories is indicated in the terminal block datasheet. Some accessories such as jumper bars may modify the terminal block's ratings: complete information in the accessories catalogue pages.

Technical data valid for copper conductors only.

DB2.5/5.2L spring terminal blocks

Miniblocks - 5 mm 0.197 in spacing



DB2.5/5.2L

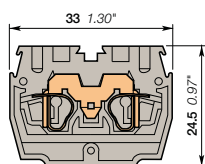

5 mm 0.197 in spacing

Description

- Save space with compact terminal blocks,
- Easy base mounting thanks to the usage of flanges,
- Easy to access thanks to the front wiring entry,
- Clamping contact pressure non dependent on the operator and automatic creeping compensation.

Ordering details

Description	Color	Type	Part Number	Pkg pce	Weight (1 pce) g
Feed-through 2 connections	Grey <input type="checkbox"/>	DB2.5/5.2L	1SNA290241R1000	100	4.00
	Blue <input type="checkbox"/>	DB2.5/5.N.2L	1SNA290243R1200	100	4.00

Main technical data

	IEC	UL	CSA
1 conductor per clamp	Rigid: Solid/Stranded	0.12-4 mm ²	26-12 AWG
	Flexible without ferrule	0.12-2.5 mm ²	
	Flexible with non insulated ferrule		
	Flexible with insulated ferrule	0.5-1.5 mm ²	
Gauge	A2		
Rated current / Rated cross section	24 A / 2.5 mm ²	15 A / 12 AWG	
Rated short-time withstand current (1s)	300 A		
Rated voltage	800 V	600 V	
Impulse withstand voltage	8000 V		
Protection	IP20	NEMA 1	

Mounting instructions

Rail		
Wire stripping length		9.5 mm 0.37 in
Tool		Flat screwdriver Ø 3.5 mm Ø 0.138 in

The connecting capacity data for one Rigid: Solid/Stranded, or one Flexible conductor (when applicable) is a mandatory information required by IEC, UL and CSA standards (Copper conductors). All other data are provided as supplementary information only. For more details, please consult our CB, UL or CSA certificates and technical datasheet available on <http://www.TE.com>



Notes

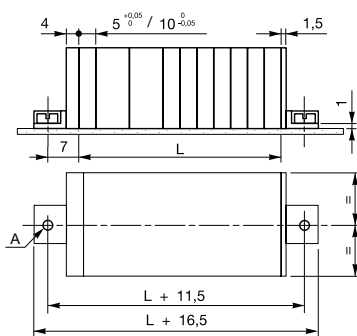

$$L = (N \text{ blocks} \times 5.05) + (N \text{ blocks} \times 10)$$

A: 2 holes DIA 3.2 mm for 3 mm screw with cylindrical head (not supplied)

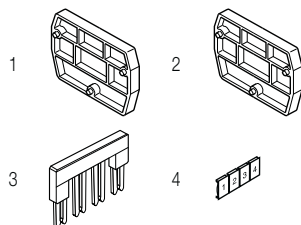

Accessories

Description	Color	Type	Part Number	Pkg pce	Weight (1 pce) g
1 End section kits	Grey <input type="checkbox"/>	FEDB.L	1SNA290281R0100	20	3.00
2 End sections 4 mm 0.157 in	Grey <input type="checkbox"/>	FED2.L	1SNA291311R2300	20	1.90
3 Jumper bars 2 poles 24 A	Orange <input type="checkbox"/>	BJDL5-2	1SNA291102R2300	50	1.00
		BJDL5-3	1SNA291103R2400	50	0.70
		BJDL5-4	1SNA291104R2500	50	0.80
		BJDL5-5	1SNA291105R2600	20	0.90
		BJDL5-10	1SNA291110R2600	20	1.20
4 Terminal block markers Blank card	White <input type="checkbox"/>	RC55	1SNA230000R1200	1	2.90

Complete list of accessories is indicated in the terminal block datasheet.

Some accessories such as jumper bars may modify the terminal block's ratings: complete information in the accessories catalogue pages.

Technical data valid for copper conductors only.

DH2.5/5.2L spring terminal blocks

Miniblocks - 5 mm 0.197 in spacing



DH2.5/5.2L

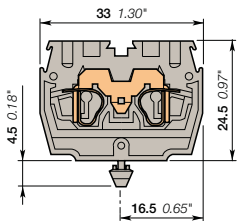

5 mm 0.197 in spacing

Description

- Save space with compact terminal blocks,
- Easy base mounting thanks to snap in mounting foot,
- Clamping contact pressure non dependent on the operator and automatic creeping compensation.

Ordering details

Description	Color	Type	Part Number	Pkg pce	Weight (1 pce) g
Feed-through 2 connections	Grey <input type="checkbox"/>	DH2.5/5.2L	1SNA290261R1400	100	4.00

Main technical data

		IEC	UL	CSA	Mounting instructions	
1 conductor per clamp	Rigid: Solid/Stranded	0.12-4 mm ²	26-12 AWG		Rail	
	Flexible without ferrule	0.12-2.5 mm ²			Wire stripping length	9.5 mm / 0.37 in
	Flexible with non insulated ferrule				Tool	Flat screwdriver Ø 3.5 mm Ø 0.138 in
	Flexible with insulated ferrule	0.5-1.5 mm ²				
Gauge		A2				
Rated current / Rated cross section		24 A / 2.5 mm ²	15 A / 12 AWG			
Rated short-time withstand current (1s)		300 A				
Rated voltage		800 V	600 V			
Impulse withstand voltage		8000 V				
Protection		IP20	NEMA 1			

The connecting capacity data for one Rigid: Solid/Stranded, or one Flexible conductor (when applicable) is a mandatory information required by IEC, UL and CSA standards (Copper conductors). All other data are provided as supplementary information only. For more details, please consult our CB, UL or CSA certificates and technical datasheet available on <http://www.TE.com>

RoHS: <input type="checkbox"/>	RoHS	USR CNR	Gost R		
--------------------------------	------	---------	--------	--	--

Notes

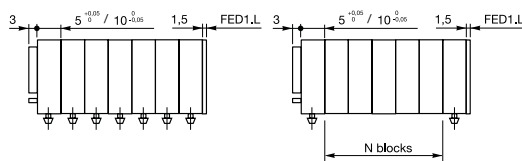

For 10 mm blocks, mount a DH block every 4 blocks.
For 5 mm blocks, mount a DH block every 8 blocks.

N blocks = 8 blocks max with 5 mm spacing
N blocks = 4 blocks max with 10 mm spacing

L = (N blocks x 5.05) + (N blocks x 10)
Panel thickness: 0.6 to 1.2 mm 0.024 to 0.047 in

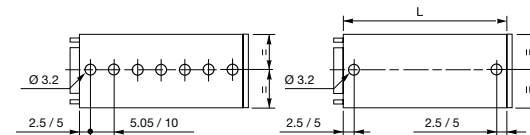

Accessories

Description	Color	Type	Part Number	Pkg pce	Weight (1 pce) g
1 End sections	Grey <input type="checkbox"/>	FED1.L	1SNA291301R0200	20	1.40
		FED2.L	1SNA291311R2300	20	1.90
2 Jumper bars	Orange <input type="checkbox"/>	BJDL5-2	1SNA291102R2300	50	1.00
		BJDL5-3	1SNA291103R2400	50	0.70
		BJDL5-4	1SNA291104R2500	50	0.80
		BJDL5-5	1SNA291105R2600	20	0.90
		BJDL5-10	1SNA291110R2600	20	1.20
3 Terminal block markers Blank card	White <input type="checkbox"/>	RC55	1SNA230000R1200	1	2.90

Complete list of accessories is indicated in the terminal block datasheet.

Some accessories such as jumper bars may modify the terminal block's ratings: complete information in the accessories catalogue pages.

Technical data valid for copper conductors only.

DS2.5/5.ADO IDC terminal blocks

Miniblocks ADO - screw clamp - 5 mm 0.197 in spacing



1SN163000014

DS2.5/5.ADO

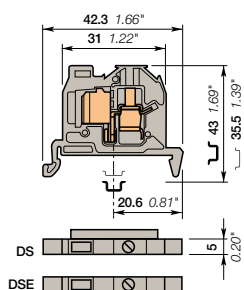

5 mm 0.197 in spacing

Description

- The mini blocks are particularly designed for applications where space is very restricted,
- With the TE Connectivity ADO System®, experience the fastest and most reliable connection on the market,
- This solution brings all the benefits of the ADO System® and allows installators to connect on standard screw clamp,
- Up to 2 wires per connection in the ADO System® connection.

Ordering details

Description	Color	Type	Part Number	Pkg pce	Weight (1 pce) g
Feed-through	Grey	DS2.5/5.ADO	1SNA399514R2300	100	4.00
	Grey	DSE2.5/5.ADO	1SNA399518R0700	20	4.00

Main technical data

	IEC	UL	CSA
ADO	Rigid: Solid/Stranded Flexible without ferrule 0.2-1 mm² 0.22-1 mm²	24-18 AWG	
Screw clamp	Rigid: Solid/Stranded Flexible without ferrule Flexible with insulated ferrule Gauge	0.2-4 mm² 0.22-2.5 mm² A3	24-12 AWG
Rated current / Rated cross section	13.5 A / 1 mm²	10 A / 18 AWG	
Rated short-time withstand current (1s)	120 A		
Rated voltage	800 V	600 V	
Impulse withstand voltage	8000 V		
Protection	IP20	NEMA 1	

Mounting instructions

	Illustration	Dimensions / Notes
Rail		TH 35-7.5, TH 35-15
Wire stripping length		9.5 mm 0.37 in
Tool		Flat screwdriver Ø 3.5 mm Ø 0.138 in
Torque		0.4 - 0.6 N.m 3.5 - 5.3 lb.in

The connecting capacity data for one Rigid: Solid/Stranded, or one Flexible conductor (when applicable) is a mandatory information required by IEC, UL and CSA standards (Copper conductors). All other data are provided as supplementary information only. For more details, please consult our CB, UL or CSA certificates and technical datasheet available on <http://www.TE.com>



Notes

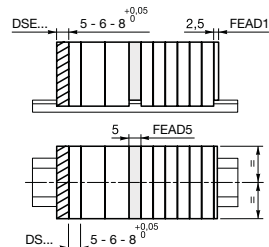

- End section FEAD1 to be mounted directly on the open part of the terminal block.
- End terminal block DSE has to be mounted at the end of the terminal blocks assembly: it reduces its size, because it suppresses the insulation rib (- 4 mm).
- Nota: This terminal block cannot be accidentally located anywhere else into the terminal block assembly (without locking holes)
- Separator FEAD5 which snaps on the terminal blocks, separates and makes visible the different parts of the terminal blocks assembly.

Accessories

Description	Color	Type	Part Number	Pkg pce	Weight (1 pce) g	
1 End stops		BAM4	1SNK900001R0000	50	14.00	
		BAZ1	1SNK900002R0000	50	5.30	
2 End sections	Grey	FEAD1	1SNA199421R1600	20	1.30	
3 Jumper bars	Orange	2 poles	BJAD05-2	1SNA205955R0300	20	1.00
		3 poles	BJAD05-3	1SNA205956R0400	20	1.00
		10 poles	BJAD05-10	1SNA205963R0300	10	5.00
4 Lateral jumper bars	Grey	2 poles	PC5-2	1SNA113542R1000	10	1.80
		10 poles	PC5-10	1SNA113544R1200	10	6.00
5 Insulating tips		EIP	1SNA113550R2400	10		
6 Circuit separators	Grey	FEAD5	1SNA199433R1200	20	1.80	
7 Tools		OUPAD	1SNA178944R0400	1	205.00	
		OUMAD	1SNA179466R0600	1	29.00	
8 Terminal block markers	White	RC55	1SNA230000R1200	1	2.90	

Complete list of accessories is indicated in the terminal block datasheet. Some accessories such as jumper bars may modify the terminal block's ratings: complete information in the accessories catalogue pages.

Technical data valid for copper conductors only.

DS4/6.ADO IDC terminal blocks

Miniblocks ADO - screw clamp - 6 mm 0.236 in spacing



1SNC16308R014

DS4/6.ADO

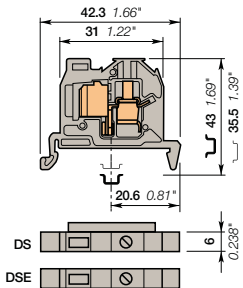

6 mm 0.236 in spacing

Description

- The mini blocks are particularly designed for applications where space is very restricted,
- With the TE Connectivity ADO System®, experience the fastest and most reliable connection on the market,
- This solution brings all the benefits of the ADO System® and allows installators to connect on standard screw clamp,
- Up to 2 wires per connection in the ADO System® connection.

Ordering details

Description	Color	Type	Part Number	Pkg pce	Weight (1 pce) g
Feed-through	Grey <input type="checkbox"/>	DS4/6.ADO	1SNA299489R0700	100	5.00
	Grey <input type="checkbox"/>	DSE4/6.ADO	1SNA299556R0100	20	5.00

Main technical data

		IEC	UL	CSA	Mounting instructions	
ADO	Rigid: Solid/Stranded	0.28-1.5 mm ²	22-16 AWG		Rail	TH 35-7.5, TH 35-15
	Flexible without ferrule	0.34-1.5 mm ²			Wire stripping length	9.5 mm 0.37 in
Screw clamp	Rigid: Solid/Stranded	0.2-4 mm ²	22-10 AWG		Tool	Flat screwdriver Ø 4 mm Ø 0.157 in
	Flexible without ferrule	0.22-4 mm ²				
	Flexible with insulated ferrule					
	Gauge	A4			Torque	0.5 - 0.8 N.m 4.4 - 7.1 lb.in
Rated current / Rated cross section		17.5 A / 1.5 mm ²	20 A / 16 AWG			
Rated short-time withstand current (1s)		180 A				
Rated voltage		800 V	600 V			
Impulse withstand voltage						
Protection		IP20	NEMA 1			

The connecting capacity data for one Rigid: Solid/Stranded, or one Flexible conductor (when applicable) is a mandatory information required by IEC, UL and CSA standards (Copper conductors). All other data are provided as supplementary information only. For more details, please consult our CB, UL or CSA certificates and technical datasheet available on <http://www.TE.com>

RoHS <input type="checkbox"/>	RoHS <input type="checkbox"/>	USR CNR <input type="checkbox"/>	Gost R <input type="checkbox"/>
-------------------------------	-------------------------------	----------------------------------	---------------------------------

Notes

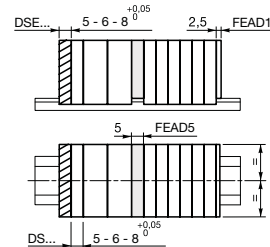

- End section FEAD1 to be mounted directly on the open part of the terminal block.
- End terminal block DSE has to be mounted at the end of the terminal blocks assembly: it reduces its size, because it suppresses the insulation rib (- 4 mm).
- Nota: This terminal block cannot be accidentally located anywhere else into the terminal block assembly (without locking holes)
- Separator FEAD5 which snaps on the terminal blocks, separates and makes visible the different parts of the terminal blocks assembly.

Accessories

Description	Color	Type	Part Number	Pkg pce	Weight (1 pce) g
1 End stops	Dark grey <input type="checkbox"/>	BAM4	1SNK900001R0000	50	14.00
		BAZ1	1SNK900002R0000	50	5.30
2 End sections	Grey <input type="checkbox"/>	FEAD1	1SNA199421R1600	20	1.30
3 Jumper bars	Orange <input type="checkbox"/>	2 poles	1SNA205974R0600	20	1.00
		3 poles	1SNA205975R0700	20	1.00
		10 poles	1SNA205982R2700	10	6.00
		2 poles	1SNA113546R1400	10	2.00
4 Lateral jumper bars	Grey <input type="checkbox"/>	3 poles	1SNA116536R0500	10	2.00
		4 poles	1SNA116537R0600	10	1.00
		10 poles	1SNA113548R2600	10	8.00
		For lateral jumper bars type PC...	EIP	1SNA113550R2400	10
5 Insulating tips					
6 Circuit separators	Grey <input type="checkbox"/>	FEAD5	1SNA199433R1200	20	1.80
7 Tools		Semi automatic tool	OUPAD	1	205.00
		Hand tool	OUMAD	1	29.00
8 Terminal block Markers	White <input type="checkbox"/>	RC65	1SNA232000R0000	1	3.60

Complete list of accessories is indicated in the terminal block datasheet.

Some accessories such as jumper bars may modify the terminal block's ratings: complete information in the accessories catalogue pages.

Technical data valid for copper conductors only.

DS4/8.ADO IDC terminal blocks

Miniblocks ADO - screw clamp - 8 mm 0.315 in spacing



1SN16308R0014

DS4/8.ADO

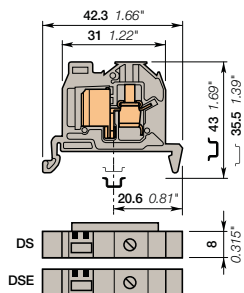

8 mm 0.315 in spacing

Description

- The mini blocks are particularly designed for applications where space is very restricted,
- With the TE Connectivity ADO System®, experience the fastest and most reliable connection on the market,
- This solution brings all the benefits of the ADO System® and allows installators to connect on standard screw clamp,
- Up to 2 wires per connection in the ADO System® connection.

Ordering details

Description	Color	Type	Part Number	Pkg pce	Weight (1 pce) g
Feed-through With rib and 2 notches for wire size 1-2.5 mm² (16-14 AWG)	Grey	DS4/8.ADO	1SNA299493R2300	100	7.00
Without rib for TB assembly extremity and 2 notches for wire size 1-2.5 mm² (16-14 AWG)	Grey	DSE4/8.ADO	1SNA299557R0200	20	7.00

Main technical data

		IEC	UL	CSA
ADO	Rigid: Solid/Stranded Flexible without ferrule	1-2.5 mm²	16-14 AWG	
Screw clamp	Rigid: Solid/Stranded Flexible without ferrule Flexible with insulated ferrule Gauge	0.2-4 mm²	22-10 AWG	
Rated current / Rated cross section		24 A / 2.5 mm²	25 A / 14 AWG	
Rated short-time withstand current (1s)		300 A		
Rated voltage		1000 V	600 V	
Impulse withstand voltage				
Protection		IP20	NEMA 1	

Mounting instructions

Rail		TH 35-7.5, TH 35-15
Wire stripping length		9.5 mm 0.37 in
Tool		Flat screwdriver Ø 4 mm Ø 0.157 in
Torque		0.5 - 0.8 N.m 4.4 - 7.1 lb.in

The connecting capacity data for one Rigid: Solid/Stranded, or one Flexible conductor (when applicable) is a mandatory information required by IEC, UL and CSA standards (Copper conductors). All other data are provided as supplementary information only. For more details, please consult our CB, UL or CSA certificates and technical datasheet available on <http://www.TE.com>

RoHS	US	PC
RoHS	USR CNR	Gost R

Notes

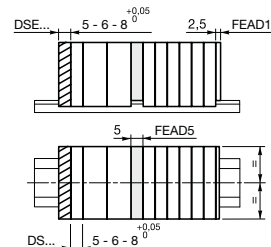

- End section FEAD1 to be mounted directly on the open part of the terminal block.
- End terminal block DSE has to be mounted at the end of the terminal blocks assembly: it reduces its size, because it suppresses the insulation rib (- 4 mm).
- Nota: This terminal block cannot be accidentally located anywhere else into the terminal block assembly (without locking holes)
- Separator FEAD5 which snaps on the terminal blocks, separates and makes visible the different parts of the terminal blocks assembly.

Accessories

Description	Color	Type	Part Number	Pkg pce	Weight (1 pce) g
1 End stops	Dark grey	BAM4	1SNK900001R0000	50	14.00
		BAZ1	1SNK900002R0000	50	5.30
2 End sections	Grey	FEAD1	1SNA199421R1600	20	1.30
3 Jumper bars	Grey	AD2.5	1SNA114205R2000	50	1.60
4 Circuit separators	Grey	FEAD5	1SNA199433R1200	20	1.80
5 Tools		Semi automatic tool	OUPAD	1	205.00
		Hand tool	OUMAD	1	29.00
6 Terminal block markers		Blank card	RCAL85	1	2.90

Complete list of accessories is indicated in the terminal block datasheet.

Some accessories such as jumper bars may modify the terminal block's ratings: complete information in the accessories catalogue pages.

Ground IDC terminal blocks

Description	Color	Type	Part Number	Pkg pce	Weight (1 pce) g
Ground	Green-yellow	DS4/8.PADO	1SNA199527R1000	100	8.00

Technical data valid for copper conductors only.

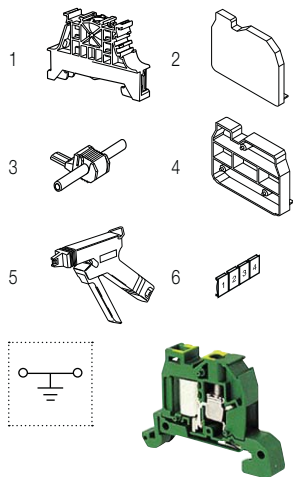

DS4/8.P.ADO IDC terminal blocks

Miniblocks ADO - screw clamp - 8 mm 0.315 in spacing

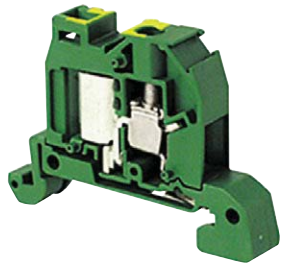

1SNK163127F0014

DS4/8.P.ADO

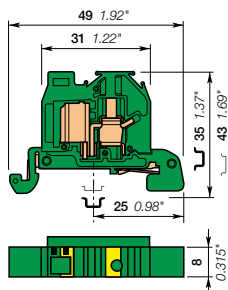

8 mm 0.315 in spacing

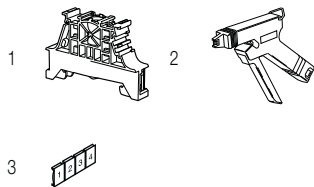

Description

- The mini blocks are particularly designed for applications where space is very restricted,
- Protect your installation in the event of a short-circuit thanks to our screwless rail contact non operator dependent,
- Secure mounting or removal from the rail,
- This solution brings all the benefits of the ADO System® and allows installators to connect on standard screw clamp,
- Up to 2 wires per connection in the ADO System® connection.

Ordering details

Description	Color	Type	Part Number	Pkg pce	Weight (1 pce) g
Ground With 2 notches for wire size 1-2.5 mm² (16-14 AWG)	Green-yellow	DS4/8.P.ADO	1SNA199527R1000	100	8.00

Main technical data

		IEC	UL	CSA	Mounting instructions	
ADO	Rigid: Solid/Stranded Flexible without ferrule	1-2.5 mm²			Rail	TH 35-7.5, TH 35-15
					Wire stripping length	9.5 mm 0.37 in
Screw clamp	Rigid: Solid/Stranded Flexible without ferrule Flexible with insulated ferrule	0.2-4 mm²			Tool	Flat screwdriver Ø 4 mm Ø 0.157 in
	Gauge	A4				
	Rated cross section	2.5 mm²				
	Rated short-time withstand current (1s)	300 A				
	Protection	IP20	NEMA 1		Torque	0.5 - 0.8 N.m 4 - 7.1 lb.in

The connecting capacity data for one Rigid: Solid/Stranded, or one Flexible conductor (when applicable) is a mandatory information required by IEC, UL and CSA standards (Copper conductors). All other data are provided as supplementary information only. For more details, please consult our CB, UL or CSA certificates and technical datasheet available on <http://www.TE.com>

	RoHS	Gost-R				
--	------	--------	--	--	--	--

Accessories

Description	Color	Type	Part Number	Pkg pce	Weight (1 pce) g
1 End stops	Dark grey	BAM4	1SNK900001R0000	50	14.00
		BAZ1	1SNK900002R0000	50	5.30
2 Tools		OUPAD	1SNA178944R0400	1	205.00
		OUMAD	1SNA179466R0600	1	29.00
3 Terminal block markers		RCAL85	1SNA237000R0500	1	2.90

Complete list of accessories is indicated in the terminal block datasheet.

Some accessories such as jumper bars may modify the terminal block's ratings: complete information in the accessories catalogue pages.

Technical data valid for copper conductors only.

DR2.5/5.ADO IDC terminal blocks

Miniblocks ADO - screw clamp - 5 mm 0.197 in spacing



DR2.5/5.ADO

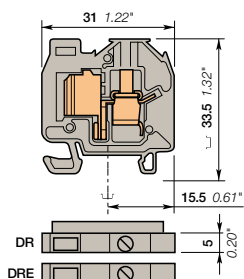

5 mm 0.197 in spacing

Description

- The mini blocks are particularly designed for applications where space is very restricted,
- With the TE Connectivity ADO System®, experience the fastest and most reliable connection on the market,
- This solution brings all the benefits of the ADO System® and allows installators to connect on standard screw clamp,
- Up to 2 wires per connection in the ADO System® connection.

Ordering details

Description	Color	Type	Part Number	Pkg pce	Weight (1 pce) g
Feed-through	Grey <input type="checkbox"/>	DR2.5/5.ADO	1SNA399509R1700	100	4.00
	Grey <input type="checkbox"/>	DRE2.5/5.ADO	1SNA399513R2200	20	4.00

Main technical data

	IEC	UL	CSA	Mounting instructions	
ADO	Rigid: Solid/Stranded Flexible without ferrule Flexible with insulated ferrule	0.2-1 mm² 0.22-1 mm²	24-18 AWG	Rail	TH 15-5.5
Screw clamp	Rigid: Solid/Stranded Flexible without ferrule Flexible with insulated ferrule	0.2-4 mm² 0.22-2.5 mm²	24-12 AWG	Wire stripping length	9.5 mm 0.374 in
Rated current / Rated cross section	13.5 A / 1 mm²	10 A / 18 AWG		Tool	Flat screwdriver Ø 3.5 mm Ø 0.138 in
Rated short-time withstand current (1s)	120 A			Torque	0.4 - 0.6 N.m 3.5 - 5.3 lb.in
Rated voltage	800 V	600 V			
Impulse withstand voltage	8000 V				
Protection	IP20	NEMA 1			

The connecting capacity data for one Rigid: Solid/Stranded, or one Flexible conductor (when applicable) is a mandatory information required by IEC, UL and CSA standards (Copper conductors). All other data are provided as supplementary information only. For more details, please consult our CB, UL or CSA certificates and technical datasheet available on <http://www.TE.com>



Notes

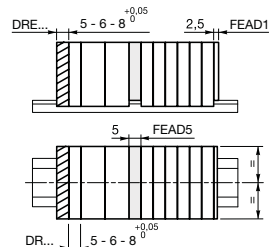

- End section FEAD1 to be mounted directly on the open part of the terminal block.
- End terminal block DRE has to be mounted at the end of the terminal blocks assembly: it reduces its size, because it suppresses the insulation rib (- 4 mm).
- Nota: This terminal block cannot be accidentally located anywhere else into the terminal block assembly (without locking holes)
- Separator FEAD5 which snaps on the terminal blocks, separates and makes visible the different parts of the terminal blocks assembly.

Accessories

Description	Color	Type	Part Number	Pkg pce	Weight (1 pce) g	
1 End stops	Grey <input type="checkbox"/>	BADRL	1SNA199420R2100	50	2.00	
2 End sections	Grey <input type="checkbox"/>	FEAD1	1SNA199421R1600	20	1.30	
3 Jumper bars	Orange <input type="checkbox"/>	2 poles	BJAD05-2	1SNA205955R0300	20	1.00
		3 poles	BJAD05-3	1SNA205956R0400	20	1.00
		10 poles	BJAD05-10	1SNA205963R0300	10	5.00
4 Lateral jumper bars	Grey <input type="checkbox"/>	2 poles	PC5-2	1SNA113542R1000	10	1.80
		10 poles	PC5-10	1SNA113544R1200	10	6.00
5 Insulating tips		For lateral jumper bars type PC...	EIP	1SNA113550R2400	10	
6 Circuit separators	Grey <input type="checkbox"/>	FEAD5	1SNA199433R1200	20	1.80	
7 Tools		Semi automatic tool	OUPAD	1SNA178944R0400	1	205.00
		Hand tool	OUMAD	1SNA179466R0600	1	29.00
8 Terminal block markers	White <input type="checkbox"/>	Blank card	RC55	1SNA230000R1200	1	2.90

Complete list of accessories is indicated in the terminal block datasheet. Some accessories such as jumper bars may modify the terminal block's ratings: complete information in the accessories catalogue pages.

Technical data valid for copper conductors only.

DR4/6.ADO IDC terminal blocks

Miniblocks ADO - screw clamp - 6 mm 0.236 in spacing



DR4/6.ADO

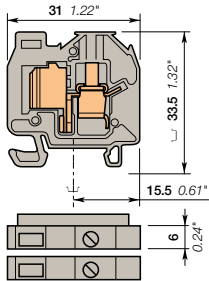

6 mm 0.236 in spacing

Description

- The mini blocks are particularly designed for applications where space is very restricted,
- With the TE Connectivity ADO System®, experience the fastest and most reliable connection on the market,
- This solution brings all the benefits of the ADO System® and allows installators to connect on standard screw clamp,
- Up to 2 wires per connection in the ADO System® connection.

Ordering details

Description	Color	Type	Part Number	Pkg pce	Weight (1 pce) g
Feed-through	Grey <input type="checkbox"/>	DR4/6.ADO	1SNA199275R0300	100	5.00
	Grey <input type="checkbox"/>	DRE4/6.ADO	1SNA299552R0500	20	5.00

Main technical data

		IEC	UL	CSA	Mounting instructions
ADO	Rigid: Solid/Stranded Flexible without ferrule	0.28-1.5 mm² 0.34-1.5 mm²	22-16 AWG		Rail TH 15-5.5 Wire stripping length 9.5 mm 0.374 in
Screw clamp	Rigid: Solid/Stranded Flexible without ferrule Flexible with insulated ferrule Gauge	0.2-4 mm² 0.22-4 mm² A4	22-10 AWG		Tool Flat screwdriver Ø 4 mm Ø 0.157 in
Rated current / Rated cross section		17.5 A / 1.5 mm²	20 A / 16 AWG		Torque 0.5 - 0.8 N.m 4.4 - 7.1 lb.in
Rated short-time withstand current (1s)		180 A			
Rated voltage		800 V	600 V		
Impulse withstand voltage		8000 V			
Protection		IP20	NEMA 1		

The connecting capacity data for one Rigid: Solid/Stranded, or one Flexible conductor (when applicable) is a mandatory information required by IEC, UL and CSA standards (Copper conductors). All other data are provided as supplementary information only. For more details, please consult our CB, UL or CSA certificates and technical datasheet available on <http://www.TE.com>



Notes

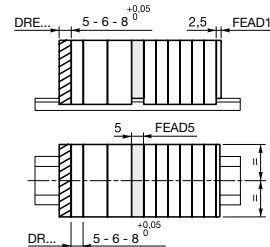

- End section FEAD1 to be mounted directly on the open part of the terminal block.
- End terminal block DRE has to be mounted at the end of the terminal blocks assembly: it reduces its size, because it suppresses the insulation rib (- 4 mm).
- Nota: This terminal block cannot be accidentally located anywhere else into the terminal block assembly (without locking holes)
- Separator FEAD5 which snaps on the terminal blocks, separates and makes visible the different parts of the terminal blocks assembly.

Accessories

Description	Color	Type	Part Number	Pkg pce	Weight (1 pce) g
1 End stops	Grey <input type="checkbox"/>	BADRL	1SNA199420R2100	50	2.00
2 End sections	Grey <input type="checkbox"/>	FEAD1	1SNA199421R1600	20	1.30
3 Jumper bars	Orange <input type="checkbox"/>	2 poles	1SNA205974R0600	20	1.00
		3 poles	1SNA205975R0700	20	1.00
		10 poles	1SNA205982R2700	10	6.00
4 Lateral jumper bars	Grey <input type="checkbox"/>	2 poles	1SNA113546R1400	10	2.00
		3 poles	1SNA116536R0500	10	2.00
		4 poles	1SNA116537R0600	10	1.00
		10 poles	1SNA113548R2600	10	8.00
5 Insulating tips		EIP	1SNA113550R2400	10	
6 Circuit separators	Grey <input type="checkbox"/>	FEAD5	1SNA199433R1200	20	1.80
7 Tools		OUPAD	1SNA178944R0400	1	205.00
		OUMAD	1SNA179466R0600	1	29.00
8 Terminal block markers	White <input type="checkbox"/>	RC65	1SNA232000R0000	1	3.60

Complete list of accessories is indicated in the terminal block datasheet.

Some accessories such as jumper bars may modify the terminal block's ratings: complete information in the accessories catalogue pages.

Technical data valid for copper conductors only.

DR4/8.ADO IDC terminal blocks

Miniblocks ADO - screw clamp - 8 mm 0.315 in spacing

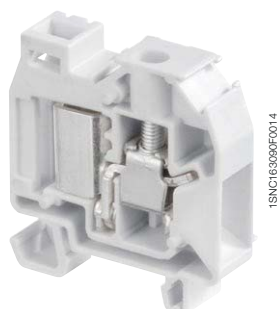

DR4/8.ADO

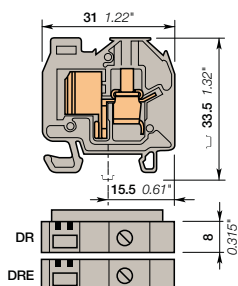

8 mm 0.315 in spacing

Description

- The mini blocks are particularly designed for applications where space is very restricted,
- With the TE Connectivity ADO System®, experience the fastest and most reliable connection on the market,
- This solution brings all the benefits of the ADO System® and allows installators to connect on standard screw clamp,
- Up to 2 wires per connection in the ADO System® connection.

Ordering details

Description	Color	Type	Part Number	Pkg pce	Weight (1 pce) g
Feed-through With rib and 2 notches for wire size 1-2.5 mm² (16-14 AWG)	Grey	DR4/8.ADO	1SNA199279R1700	100	7.00

Main technical data

	IEC	UL	CSA	Mounting instructions	
ADO	Rigid: Solid/Stranded Flexible without ferrule Flexible with ferrule	1-2.5 mm² 1-2.5 mm²	16-14 AWG	Rail	TH 15-5.5
Screw clamp	Rigid: Solid/Stranded Flexible without ferrule Flexible with insulated ferrule Gauge	0.2-4 mm² 0.22-4 mm² A4	22-10 AWG	Wire stripping length	9.5 mm 0.374 in
Rated current / Rated cross section	24 A / 2.5 mm²	25 A / 14 AWG		Tool	Flat screwdriver Ø 4 mm Ø 0.157 in
Rated short-time withstand current (1s)	300 A			Torque	0.5 - 0.8 N.m 4.4 - 7.1 lb.in
Rated voltage	1000 V	600 V			
Impulse withstand voltage	8000 V				
Protection	IP20	NEMA 1			

The connecting capacity data for one Rigid: Solid/Stranded, or one Flexible conductor (when applicable) is a mandatory information required by IEC, UL and CSA standards (Copper conductors). All other data are provided as supplementary information only. For more details, please consult our CB, UL or CSA certificates and technical datasheet available on <http://www.TE.com>

RoHS	UL	Gost R							
RoHS	UL	Gost R							

Notes

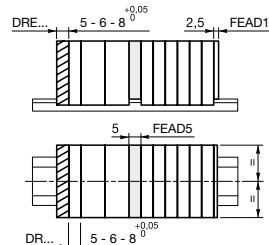

- End section FEAD1 to be mounted directly on the open part of the terminal block.
- End terminal block DRE has to be mounted at the end of the terminal blocks assembly: it reduces its size, because it suppresses the insulation rib (- 4 mm).
- Nota: This terminal block cannot be accidentally located anywhere else into the terminal block assembly (without locking holes)
- Separator FEAD5 which snaps on the terminal blocks, separates and makes visible the different parts of the terminal blocks assembly.

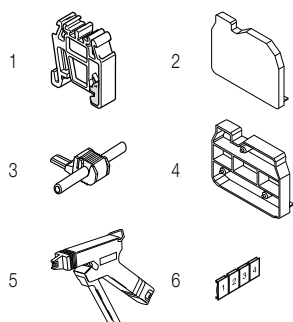

Accessories

Description	Color	Type	Part Number	Pkg pce	Weight (1 pce) g
1 End stops 6.5 mm 0.256 in	Grey	BADRL	1SNA199420R2100	50	2.00
2 End sections 2.5 mm 0.098 in	Grey	FEAD1	1SNA199421R1600	20	1.30
3 Jumper bars 1 poles 24 A	Grey	AD2.5	1SNA114205R2000	50	1.60
4 Circuit separators 5 mm 0.197 in	Grey	FEAD5	1SNA199433R1200	20	1.80
5 Tools Semi automatic tool		OUPAD	1SNA178944R0400	1	205.00
Hand tool		OUMAD	1SNA179466R0600	1	29.00
6 Terminal block markers Blank card		RCAL85	1SNA237000R0500	1	2.90

Complete list of accessories is indicated in the terminal block datasheet. Some accessories such as jumper bars may modify the terminal block's ratings: complete information in the accessories catalogue pages.

Ground IDC terminal blocks

Description	Color	Type	Part Number	Pkg pce	Weight (1 pce) g
Ground Profile aligned with DR4/8.ADO	Green-yellow	DR4/8.P.ADO	1SNA299632R0500	100	8.00

Technical data valid for copper conductors only.

DR4/8.P.ADO IDC Terminal Blocks

Miniblocks ADO - screw clamp - 8 mm 0.315 in Spacing



2.5 mm²



1SNC163144F0014

DR4/8.P.ADO

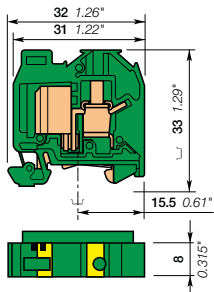

8 mm 0.315 in Spacing

Description

- The mini blocks are particularly designed for applications where space is very restricted,
- Protect your installation in the event of a short-circuit thanks to our screwless rail contact non operator dependent,
- Secure mounting or removal from the rail,
- This solution brings all the benefits of the ADO System® and allows installators to connect on standard screw clamp,
- Up to 2 wires per connection in the ADO System® connection.

Ordering Details

Description	Color	Type	Part Number	Pkg pce	Weight (1 pce) g
Ground Ground with 2 notches for wire size 1-2.5 mm ² (16-14 AWG)	Green-Yellow	DR4/8.P.ADO	1SNA299632R0500	100	8.00

Main Technical Data

		IEC	UL	CSA	Mounting Instructions		
ADO	Rigid: Solid/Stranded Flexible without ferrule	1-2.5 mm ² 1-2.5 mm ²			Rail		TH 15-5.5
					Wire stripping length		9.5 mm 0.374 in
Screw clamp	Rigid: Solid/Stranded Flexible without ferrule Flexible with insulated ferrule Gauge	0.2-4 mm ² 0.22-4 mm ² A4			Tool		Flat screwdriver Ø 4 mm Ø 0.157 in
Rated cross section		2.5 mm ²			Torque		0.5 - 0.8 N.m 4.4 - 7.1 lb.in
Rated short-time withstand current (1s)		300 A					
Protection			NEMA				

The connecting capacity data for one Rigid: Solid/Stranded, or one Flexible conductor (when applicable) is a mandatory information required by IEC, UL and CSA standards (Copper conductors). All other data are provided as supplementary information only. For more details, please consult our CB, UL or CSA certificates and technical datasheet available on <http://www.TE.com>

RoHS		Gost R	
------	--	--------	--

Accessories

Description	Color	Type	Part Number	Pkg pce	Weight (1 pce) g
1 End Stops	Grey	BADRL	1SNA199420R2100	50	2.00
2 End Sections	Grey	FEAD1	1SNA199421R1600	20	1.30
3 Tools		OUPAD	1SNA178944R0400	1	205.00
		OUMAD	1SNA179466R0600	1	29.00
4 Terminal block markers		RCAL85	1SNA237000R0500	1	2.90

Complete list of accessories is indicated in the terminal block datasheet.

Some accessories such as jumper bars may modify the terminal block's ratings: complete information in the accessories catalogue pages.

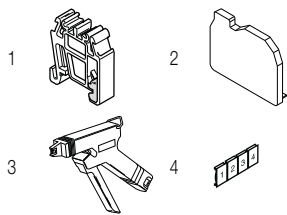

Technical data valid for copper conductors only.

DB2.5/5.ADO IDC terminal blocks

Miniblocks ADO - screw clamp - 5 mm 0.197 in spacing



1SNC163049R0014

DB2.5/5.ADO

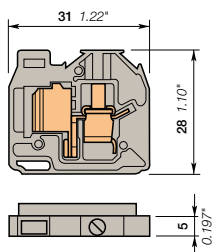

5 mm 0.197 in spacing

Description

- The mini blocks are particularly designed for applications where space is very restricted,
- With the TE Connectivity ADO System®, experience the fastest and most reliable connection on the market,
- This solution brings all the benefits of the ADO System® and allows installators to connect on standard screw clamp,
- Easy base mounting thanks to the usage of flanges.
- Up to 2 wires per connection in the ADO System® connection.

Ordering details

Description	Color	Type	Part Number	Pkg pce	Weight (1 pce) g
Feed-through	Grey <input type="checkbox"/>	DB2.5/5.ADO	1SNA399519R0000	100	4.00

Main technical data

		IEC	UL	CSA	Mounting instructions	
ADO	Rigid: Solid/Stranded Flexible without ferrule	0.2-1 mm² 0.22-1 mm²	24-18 AWG		Rail	
Screw clamp	Rigid: Solid/Stranded Flexible without ferrule Flexible with insulated ferrule Gauge	0.2-4 mm² 0.22-2.5 mm² A3	24-12 AWG		Wire stripping length	9.5 mm 0.374 in
Rated current / Rated cross section		13.5 A / 1 mm²	10 A / 18 AWG		Tool	Flat screwdriver Ø 3.5 mm Ø 0.138 in
Rated short-time withstand current (1s)		120 A			Torque	0.4 - 0.6 N.m 3.5 - 5.3 lb.in
Rated voltage		800 V	600 V			
Impulse withstand voltage		8000 V				
Protection		IP20	NEMA 1			

The connecting capacity data for one Rigid: Solid/Stranded, or one Flexible conductor (when applicable) is a mandatory information required by IEC, UL and CSA standards (Copper conductors). All other data are provided as supplementary information only. For more details, please consult our CB, UL or CSA certificates and technical datasheet available on <http://www.TE.com>

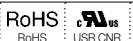

Notes

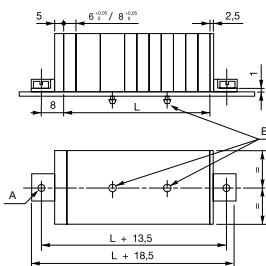

- A: 2 holes DIA 3.2 mm for 3 mm screw max. with cylindrical head (not supplied).
- L = (N blocks x 6) + (N blocks x 8)
- Plate thickness 0.6 to 1.2 mm
- Intermediate mounting of DH blocks every 2 blocks (spacing 8 mm) or 3 blocks (spacing 6 mm)

Accessories

Description	Color	Type	Part Number	Pkg pce	Weight (1 pce) g
1 End section kits	Grey <input type="checkbox"/>	FEAD3	1SNA199437R1600	20	3.00
2 Jumper bars	Orange <input type="checkbox"/>	BJAD05-2 BJAD05-3 BJAD05-10	1SNA205955R0300 1SNA205956R0400 1SNA205963R0300	20 20 10	1.00 1.00 5.00
3 Lateral jumper bars	Grey <input type="checkbox"/>	PC5-2 PC5-10	1SNA113542R1000 1SNA113544R1200	10 10	1.80 6.00
4 Insulating tips		EIP	1SNA113550R2400	10	
5 Circuit separators	Grey <input type="checkbox"/>	FEAD5	1SNA199433R1200	20	1.80
6 Tools		OUPAD OUMAD	1SNA178944R0400 1SNA179466R0600	1 1	205.00 29.00
7 Terminal block markers	White <input type="checkbox"/>	RC55	1SNA230000R1200	1	2.90

Complete list of accessories is indicated in the terminal block datasheet. Some accessories such as jumper bars may modify the terminal block's ratings: complete information in the accessories catalogue pages.

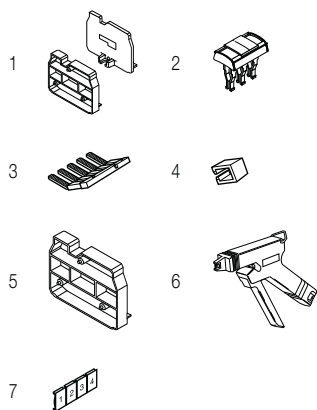

Technical data valid for copper conductors only.

DB4/6.ADO IDC terminal blocks

Miniblocks ADO - screw clamp - 6 mm 0.236 in spacing



1SNC163049FC014

DB4/6.ADO

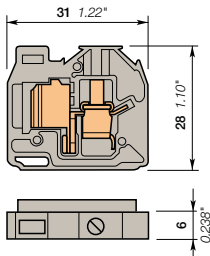

6 mm 0.236 in spacing

Description

- The mini blocks are particularly designed for applications where space is very restricted,
- With the TE Connectivity ADO System®, experience the fastest and most reliable connection on the market,
- This solution brings all the benefits of the ADO System® and allows installators to connect on standard screw clamp,
- Easy base mounting thanks to the usage of flanges.
- Up to 2 wires per connection in the ADO System® connection.

Ordering details

Description	Color	Type	Part Number	Pkg pce	Weight (1 pce) g
Feed-through	Grey <input type="checkbox"/>	DB4/6.ADO	1SNA299505R0700	100	5.00

Main technical data

		IEC	UL	CSA	Mounting instructions	
ADO	Rigid: Solid/Stranded	0.28-1.5 mm²	22-16 AWG		Rail	
	Flexible without ferrule	0.34-1.5 mm²	22-16 AWG			Wire stripping length
Screw clamp	Rigid: Solid/Stranded	0.2-4 mm²	22-10 AWG		Tool	Flat screwdriver Ø 4 mm Ø 0.157 in
	Flexible without ferrule	0.22-4 mm²				
	Flexible with insulated ferrule					
Gauge		A4			Torque	0.5 - 0.8 N.m 4.4 - 7.1 lb.in
Rated current / Rated cross section		17.5 A / 1.5 mm²	20 A / 16 AWG			
Rated short-time withstand current (1s)		180 A				
Rated voltage		800 V	600 V			
Impulse withstand voltage		8000 V				
Protection		IP20	NEMA 1			

The connecting capacity data for one Rigid: Solid/Stranded, or one Flexible conductor (when applicable) is a mandatory information required by IEC, UL and CSA standards (Copper conductors). All other data are provided as supplementary information only. For more details, please consult our CB, UL or CSA certificates and technical datasheet available on <http://www.TE.com>



Notes

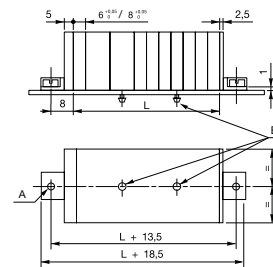

A: 2 holes DIA 3.2 mm for 3 mm screw max. with cylindrical head (not supplied).

L = (N blocks x 6) + (N blocks x 8)

Plate thickness 0.6 to 1.2 mm

Intermediate mounting of DH blocks every 2 blocks (spacing 8 mm) or 3 blocks (spacing 6 mm)

Accessories

Description	Color	Type	Part Number	Pkg pce	Weight (1 pce) g	
1 End section kits	Grey <input type="checkbox"/>	FEAD3	1SNA199437R1600	20	3.00	
2 Jumper bars	Orange <input type="checkbox"/>	2 poles 17.5 A	BJADO6-2	1SNA205974R0600	20	1.00
		3 poles	BJADO6-3	1SNA205975R0700	20	1.00
		10 poles	BJADO6-10	1SNA205982R2700	10	6.00
3 Lateral jumper bars	Grey <input type="checkbox"/>	2 poles 35 A	PC6-2	1SNA113546R1400	10	2.00
		3 poles	PC6-3	1SNA116536R0500	10	2.00
		4 poles	PC6-4	1SNA116537R0600	10	1.00
		10 poles	PC6-10	1SNA113548R2600	10	8.00
		4 Insulating tips		EIP	1SNA113550R2400	10
5 Circuit separators	Grey <input type="checkbox"/>	FEAD5	1SNA199433R1200	20	1.80	
6 Tools		OUPAD	1SNA178944R0400	1	205.00	
		OCUMAD	1SNA179466R0600	1	29.00	
7 Terminal block markers	White <input type="checkbox"/>	RC65	1SNA232000R0000	1	3.60	

Complete list of accessories is indicated in the terminal block datasheet.

Some accessories such as jumper bars may modify the terminal block's ratings: complete information in the accessories catalogue pages.

Technical data valid for copper conductors only.

DB4/8.ADO IDC terminal blocks

Miniblocks ADO - screw clamp - 8 mm 0.315 in spacing



1SNC163037S02014

DB4/8.ADO

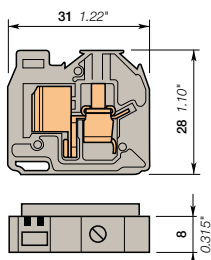

8 mm 0.315 in spacing

Description

- The mini blocks are particularly designed for applications where space is very restricted,
- With the TE Connectivity ADO System®, experience the fastest and most reliable connection on the market,
- This solution brings all the benefits of the ADO System® and allows installators to connect on standard screw clamp,
- Easy base mounting thanks to the usage of flanges.
- Up to 2 wires per connection in the ADO System® connection.

Ordering details

Description	Color	Type	Part Number	Pkg pce	Weight (1 pce) g
Feed-through With 2 notches for wire size 1-2.5 mm² (16-14 AWG)	Grey <input type="checkbox"/>	DB4/8.ADO	1SNA299509R1300	100	7.00

Main technical data

	IEC	UL	CSA	Mounting instructions
ADO	Rigid: Solid/Stranded Flexible without ferrule 1-2.5 mm² 1-2.5 mm²	16-14 AWG		Rail Wire stripping length 9.5 mm 0.374 in
Screw clamp	Rigid: Solid/Stranded Flexible without ferrule Flexible with insulated ferrule Gauge	0.2-4 mm² 0.22-4 mm² A4	22-10 AWG	Tool Flat screwdriver Ø 4 mm Ø 0.157 in
Rated current / Rated cross section	24 A / 2.5 mm²	25 A / 14 AWG		Torque 0.5 - 0.8 N.m 4.4 - 7.1 lb.in
Rated short-time withstand current (1s)	300 A			
Rated voltage	800 V	600 V		
Impulse withstand voltage	8000 V			
Protection	IP20	NEMA 1		

The connecting capacity data for one Rigid: Solid/Stranded, or one Flexible conductor (when applicable) is a mandatory information required by IEC, UL and CSA standards (Copper conductors). All other data are provided as supplementary information only. For more details, please consult our CB, UL or CSA certificates and technical datasheet available on <http://www.TE.com>

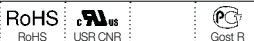

Notes

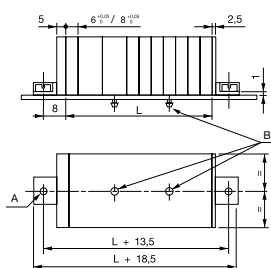

- A: 2 holes DIA 3.2 mm for 3 mm screw max. with cylindrical head (not supplied).
- L = (N blocks x 6) + (N blocks x 8)
- Plate thickness 0.6 to 1.2 mm
- Intermediate mounting of DH blocks every 2 blocks (spacing 8 mm) or 3 blocks (spacing 6 mm)

Accessories

Description	Color	Type	Part Number	Pkg pce	Weight (1 pce) g
1 End section kits	Grey <input type="checkbox"/>	FEAD3	1SNA199437R1600	20	3.00
2 Jumper bars 1 poles 24 A	Grey <input type="checkbox"/>	AD2.5	1SNA114205R2000	50	1.60
3 Circuit separators 5 mm 0.197 in	Grey <input type="checkbox"/>	FEAD5	1SNA199433R1200	20	1.80
4 Tools Semi automatic tool		OUPAD	1SNA178944R0400	1	205.00
Hand tool		OUMAD	1SNA179466R0600	1	29.00
5 Terminal block markers Blank card		RCAL85	1SNA237000R0500	1	2.90

Complete list of accessories is indicated in the terminal block datasheet. Some accessories such as jumper bars may modify the terminal block's ratings: complete information in the accessories catalogue pages.

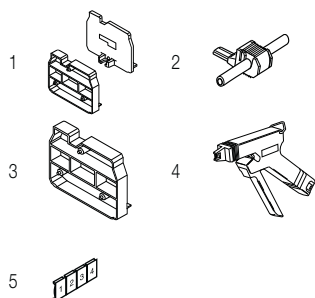

Technical data valid for copper conductors only.

DH4/6.ADO IDC terminal blocks

Miniblocks ADO - screw clamp - 6 mm 0.236 in spacing



1SNC16304BFC014

DH4/6.ADO

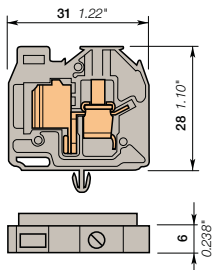

6 mm 0.236 in spacing

Description

- The mini blocks are particularly designed for applications where space is very restricted,
- With the TE Connectivity ADO System®, experience the fastest and most reliable connection on the market,
- This solution brings all the benefits of the ADO System® and allow installators to connect on standard screw clamp,
- Easy base mounting thanks to snap in mounting foot,
- Up to 2 wires per connection in the ADO System® connection.

Ordering details

Description	Color	Type	Part Number	Pkg pce	Weight (1 pce) g
Feed-through	Grey <input type="checkbox"/>	DH4/6.ADO	1SNA299521R2600	100	5.00

Main technical data

		IEC	UL	CSA	Mounting instructions	
ADO	Rigid: Solid/Stranded	0.28-1.5 mm ²	22-16 AWG		Rail	
	Flexible without ferrule	0.34-1.5 mm ²				Wire stripping length
Screw clamp	Rigid: Solid/Stranded	0.2-4 mm ²	22-10 AWG		Tool	Flat screwdriver Ø 4 mm Ø 0.157 in
	Flexible without ferrule	0.22-4 mm ²				
	Flexible with insulated ferrule					
Gauge		A4			Torque	0.5 - 0.8 N.m 4.4 - 7.1 lb.in
Rated current / Rated cross section		17.5 A / 1.5 mm ²	20 A / 16 AWG			
Rated short-time withstand current (1s)		180 A				
Rated voltage		800 V	600 V			
Impulse withstand voltage		8000 V				
Protection		IP20	NEMA 1			

The connecting capacity data for one Rigid: Solid/Stranded, or one Flexible conductor (when applicable) is a mandatory information required by IEC, UL and CSA standards (Copper conductors). All other data are provided as supplementary information only. For more details, please consult our CB, UL or CSA certificates and technical datasheet available on <http://www.TE.com>



Notes

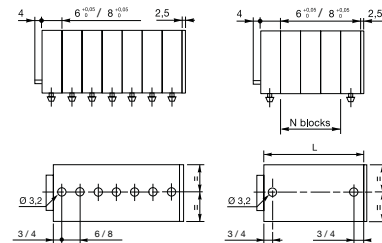

L = (N blocks x 6) + (N blocks x 8)
 N blocks = 3 blocks max. with 6 mm spacing
 2 blocks max. with 8 mm spacing
 Plate thickness 0.6 to 1.2 mm

Accessories

Description	Color	Type	Part Number	Pkg pce	Weight (1 pce) g	
1 End section	Grey <input type="checkbox"/>	FEAD1	1SNA199421R1600	20	1.30	
2 Jumper bars	Orange <input type="checkbox"/>	2 poles 17.5 A	BJADO6-2	1SNA205974R0600	20	1.00
		3 poles	BJADO6-3	1SNA205975R0700	20	1.00
		10 poles	BJADO6-10	1SNA205982R2700	10	6.00
3 Lateral jumper bars	Grey <input type="checkbox"/>	2 poles 35 A	PC6-2	1SNA113546R1400	10	2.00
		3 poles	PC6-3	1SNA116536R0500	10	2.00
		4 poles	PC6-4	1SNA116537R0600	10	1.00
		10 poles	PC6-10	1SNA113548R2600	10	8.00
		4 Insulating tips		EIP	1SNA113550R2400	10
5 Circuit separators	Grey <input type="checkbox"/>	FEAD5	1SNA199433R1200	20	1.80	
6 Tools		OUPAD	1SNA178944R0400	1	205.00	
		UMAD	1SNA179466R0600	1	29.00	
7 Terminal block markers	White <input type="checkbox"/>	RC65	1SNA232000R0000	1	3.60	

Complete list of accessories is indicated in the terminal block datasheet. Some accessories such as jumper bars may modify the terminal block's ratings: complete information in the accessories catalogue pages.

Technical data valid for copper conductors only.

DS1.5/6.ADO IDC terminal blocks

Miniblocks ADO - ADO - 6 mm 0.236 in spacing



1SN1C16306SF014

DS1.5/6.ADO

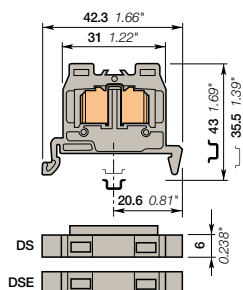

6 mm 0.236 in spacing

Description

- The mini blocks are particularly designed for applications where space is very restricted,
- With the TE Connectivity ADO System®, experience the fastest and most reliable connection on the market,
- Designed for control applications exposed to severe constrains (vibrations, shocks, corrosion etc.),
- Up to 2 wires per connection.

Ordering details

Description	Color	Type	Part Number	Pkg pce	Weight (1 pce) g
Feed-through With rib	Grey	DS1.5/6.ADO	1SNA299497R2700	100	4.00
Without rib for TB assembly extremity	Grey	DSE1.5/6.ADO	1SNA299558R1300	20	4.00

Main technical data

	IEC	UL	CSA	Mounting instructions
ADO	Rigid: Solid/Stranded Flexible without ferrule Flexible with insulated ferrule	0.28-1.5 mm² 0.34-1.5 mm²	22-16 AWG	Rail Wire stripping length Tool
Screw clamp	Rigid: Solid/Stranded Flexible without ferrule Flexible with insulated ferrule	Gauge		Torque
Rated current / Rated cross section	17.5 A / 1.5 mm²	20 A / 16 AWG		
Rated short-time withstand current (1s)	180 A			
Rated voltage	1000 V	600 V		
Impulse withstand voltage				
Protection	IP20	NEMA 1		

The connecting capacity data for one Rigid: Solid/Stranded Flexible conductor (when applicable) is a mandatory information required by IEC, UL and CSA standards (Copper conductors). All other data are provided as supplementary information only. For more details, please consult our CB, UL or CSA certificates and technical datasheet available on <http://www.TE.com>



Notes

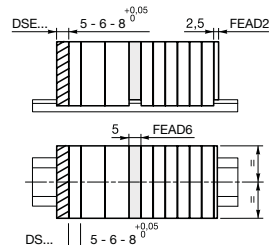

- End section FEAD2 to be mounted directly on the open part of the terminal block.
- End terminal block DSE has to be mounted at the end of the terminal blocks assembly: It reduces its size, because it suppresses the insulation rib (- 4 mm).
- Nota: This terminal block cannot be accidentally located anywhere else into the terminal block assembly (without locking holes)
- Separator FEAD6 which snaps on the terminal blocks, separates and makes visible the different parts of the terminal blocks assembly.

Accessories

Description	Color	Type	Part Number	Pkg pce	Weight (1 pce) g
1 End stops	Dark grey	BAM4	1SNK900001R0000	50	14.00
		BAZ1	1SNK900002R0000	50	5.30
2 End sections	Grey	FEAD2	1SNA199423R1000	20	1.30
3 Jumper bars	Orange	BJADO6-2	1SNA205974R0600	20	1.00
		BJADO6-3	1SNA205975R0700	20	1.00
		BJADO6-10	1SNA205982R2700	10	6.00
4 Circuit separators	Grey	FEAD6	1SNA199435R1400	20	1.80
5 Tools		OUPAD	1SNA178944R0400	1	205.00
		OUMAD	1SNA179466R0600	1	29.00
6 Terminal block markers	White	RC65	1SNA232000R0000	1	3.60

Complete list of accessories is indicated in the terminal block datasheet. Some accessories such as jumper bars may modify the terminal block's ratings: complete information in the accessories catalogue pages.

Technical data valid for copper conductors only.

DS2.5/8.ADO IDC terminal blocks

Miniblocks ADO - ADO - 8 mm 0.315 in spacing



DS2.5/8.ADO

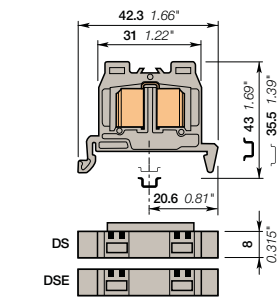

8 mm 0.315 in spacing

Description

- The mini blocks are particularly designed for applications where space is very restricted,
- With the TE Connectivity ADO System®, experience the fastest and most reliable connection on the market,
- Designed for control applications exposed to severe constrains (vibrations, shocks, corrosion etc.),
- Up to 2 wires per connection.

Ordering details

Description	Color	Type	Part Number	Pkg pce	Weight (1 pce) g
Feed-through With rib and 2 notches for wire size 1-2.5 mm² (16-14 AWG)	Grey	DS2.5/8.ADO	1SNA299501R0300	100	6.00
Without rib for TB assembly extremity and 2 notches for wire size 1-2.5 mm² (16-14 AWG)	Grey	DSE2.5/8.ADO	1SNA299559R1400	20	6.00

Main technical data

	IEC	UL	CSA	Mounting instructions
ADO	Rigid: Solid/Stranded Flexible without ferrule 1-2.5 mm²	16-14 AWG		Rail Wire stripping length Tool
Screw clamp	Rigid: Solid/Stranded Flexible without ferrule Flexible with insulated ferrule Gauge			Torque
Rated current / Rated cross section	24 A / 2.5 mm²	25 A / 14 AWG		
Rated short-time withstand current (1s)	300 A			
Rated voltage	1000 V	600 V		
Impulse withstand voltage				
Protection	IP20	NEMA 1		

The connecting capacity data for one Rigid: Solid/Stranded, or one Flexible conductor (when applicable) is a mandatory information required by IEC, UL and CSA standards (Copper conductors). All other data are provided as supplementary information only. For more details, please consult our CB, UL or CSA certificates and technical datasheet available on <http://www.TE.com>

RoHS REHS	CCSAus	Gost R							
--------------	--------	--------	--	--	--	--	--	--	--

Notes

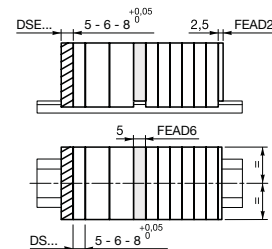

- End section FEAD2 to be mounted directly on the open part of the terminal block.
- End terminal block DSE has to be mounted at the end of the terminal blocks assembly: It reduces its size, because it suppresses the insulation rib (- 4 mm).
- Nota: This terminal block cannot be accidentally located anywhere else into the terminal block assembly (without locking holes)
- Separator FEAD6 which snaps on the terminal blocks, separates and makes visible the different parts of the terminal blocks assembly.

Accessories

Description	Color	Type	Part Number	Pkg pce	Weight (1 pce) g
1 End stops	Dark grey	BAM4	1SNK900001R0000	50	14.00
		BAZ1	1SNK900002R0000	50	5.30
2 End sections	Grey	FEAD2	1SNA199423R1000	20	1.30
3 Circuit separators	Grey	FEAD6	1SNA199435R1400	20	1.80
4 Tools		OUPAD	1SNA178944R0400	1	205.00
		OUMAD	1SNA179466R0600	1	29.00
5 Terminal block markers		RCAL85	1SNA237000R0500	1	2.90

Complete list of accessories is indicated in the terminal block datasheet.

Some accessories such as jumper bars may modify the terminal block's ratings: complete information in the accessories catalogue pages.

Ground IDC terminal blocks

Description	Color	Type	Part Number	Pkg pce	Weight (1 pce) g
Ground Profile aligned with DS2.5/8.ADO	Green-yellow	DS2.5/8.P.ADO	1SNA199528R2100	100	10.00

Technical data valid for copper conductors only.

DS2.5/8.P.ADO IDC terminal blocks

Miniblocks ADO - ADO - 8 mm 0.315 in spacing



1SNK163140F0014

DS2.5/8.P.ADO

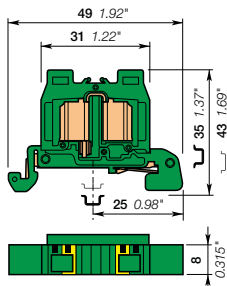

8 mm 0.315 in spacing

Description

- The mini blocks are particularly designed for applications where space is very restricted,
- Protect your installation in the event of a short-circuit thanks to our screwless rail contact non operator dependent,
- Secure mounting or removal from the rail,
- With the TE Connectivity ADO System®, experience the fastest and most reliable connection on the market,
- Up to 2 wires per connection.

Ordering details

Description	Color	Type	Part Number	Pkg pce	Weight (1 pce) g
Ground With 2 notches for wire size 1-2.5 mm ² (16-14 AWG)	Green-yellow	DS2.5/8.P.ADO	1SNA199528R2100	100	10.00

Main technical data

	IEC	UL	CSA	Mounting instructions
ADO	Rigid: Solid/Stranded Flexible without ferrule Flexible with insulated ferrule	1-2.5 mm ² 1-2.5 mm ²	16-14 AWG	Rail TH 35-7.5, TH 35-15 Wire stripping length
Screw clamp	Rigid: Solid/Stranded Flexible without ferrule Flexible with insulated ferrule			Tool
Rated cross section	2.5 mm ²	14 AWG		
Rated short-time withstand current (1s)	300 A			
Protection	IP20	NEMA 1		Torque

The connecting capacity data for one Rigid: Solid/Stranded, or one Flexible conductor (when applicable) is a mandatory information required by IEC, UL and CSA standards (Copper conductors). All other data are provided as supplementary information only. For more details, please consult our CB, UL or CSA certificates and technical datasheet available on <http://www.TE.com>

RoHS			
RoHS	cCSAus	Gost R	

Accessories

Description	Color	Type	Part Number	Pkg pce	Weight (1 pce) g
1 End stops	Dark grey	BAM4	1SNK900001R0000	50	14.00
		BAZ1	1SNK900002R0000	50	5.30
2 End sections	Grey	FEAD2	1SNA199423R1000	20	1.30
3 Tools		Semi automatic tool	OUPAD	1	205.00
		Hand tool	OUMAD	1	29.00
4 Terminal block markers		Blank card	RCAL85	1	2.90

Complete list of accessories is indicated in the terminal block datasheet.

Some accessories such as jumper bars may modify the terminal block's ratings: complete information in the accessories catalogue pages.

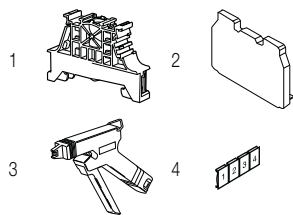

Technical data valid for copper conductors only.

DR1/5.ADO IDC terminal blocks

Miniblocks ADO - ADO - 5 mm 0.197 in spacing



DR1/5.ADO

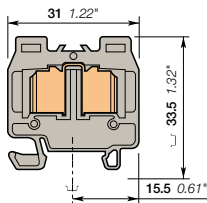

5 mm 0.197 in spacing

Description

- The mini blocks are particularly designed for applications where space is very restricted,
- With the TE Connectivity ADO System®, experience the fastest and most reliable connection on the market,
- Designed for control applications exposed to severe constrains (vibrations, shocks, corrosion etc.),
- Up to 2 wires per connection.

Ordering details

Description	Color	Type	Part Number	Pkg pce	Weight (1 pce) g
Feed-through	Grey <input type="checkbox"/>	DR1/5.ADO	1SNA399491R2500	100	3.00
	Grey <input type="checkbox"/>	DRE1/5.ADO	1SNA399495R2100	20	3.00

Main technical data

		IEC	UL	CSA	Mounting instructions	
ADO	Rigid: Solid/Stranded	0.2-1 mm ²	24-18 AWG		Rail	
	Flexible without ferrule	0.22-1 mm ²			Wire stripping length	
Screw clamp	Rigid: Solid/Stranded				Tool	
	Flexible without ferrule					
	Flexible with insulated ferrule					
	Gauge					
Rated current / Rated cross section		13.5 A / 1 mm ²	10 A / 18 AWG		Torque	
Rated short-time withstand current (1s)		120 A				
Rated voltage		1000 V	600 V			
Impulse withstand voltage		8000 V				
Protection		IP20	NEMA 1			

The connecting capacity data for one Rigid: Solid/Stranded, or one Flexible conductor (when applicable) is a mandatory information required by IEC, UL and CSA standards (Copper conductors). All other data are provided as supplementary information only. For more details, please consult our CB, UL or CSA certificates and technical datasheet available on <http://www.TE.com>



Notes

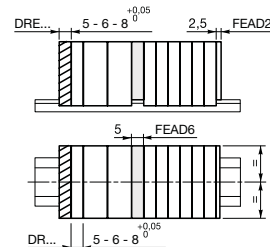

- End section FEAD1 to be mounted directly on the open part of the terminal block.
- End terminal block DRE has to be mounted at the end of the terminal blocks assembly: it reduces its size, because it suppresses the insulation rib (- 4 mm).
- Nota: This terminal block cannot be accidentally located anywhere else into the terminal block assembly (without locking holes)
- Separator FEAD5 which snaps on the terminal blocks, separates and makes visible the different parts of the terminal blocks assembly.

Accessories

Description	Color	Type	Part Number	Pkg pce	Weight (1 pce) g	
1 End stops	Grey <input type="checkbox"/>	BADRL	1SNA199420R2100	50	2.00	
2 End sections	Grey <input type="checkbox"/>	FEAD2	1SNA199423R1000	20	1.30	
3 Jumper bars	Orange <input type="checkbox"/>	2 poles	BJADO5-2	1SNA205955R0300	20	1.00
		3 poles	BJADO5-3	1SNA205956R0400	20	1.00
		10 poles	BJADO5-10	1SNA205963R0300	10	5.00
4 Circuit separators	Grey <input type="checkbox"/>	FEAD6	1SNA199435R1400	20	1.80	
5 Tools		Semi automatic tool	OUPAD	1	205.00	
		Hand tool	OUMAD	1	29.00	
6 Terminal block markers	White <input type="checkbox"/>	RC55	1SNA230000R1200	1	2.90	

Complete list of accessories is indicated in the terminal block datasheet.

Some accessories such as jumper bars may modify the terminal block's ratings: complete information in the accessories catalogue pages.

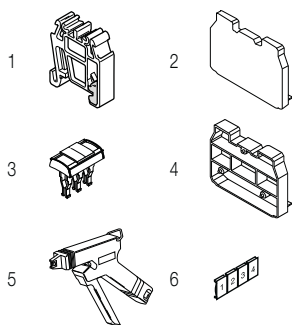

Technical data valid for copper conductors only.

DR1.5/6.ADO IDC terminal blocks

Miniblocks ADO - ADO - 6 mm 0.236 in spacing

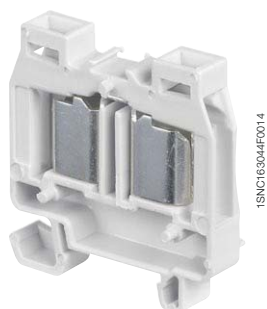

DR1.5/6.ADO

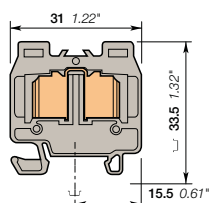

6 mm 0.236 in spacing

Description

- The mini blocks are particularly designed for applications where space is very restricted,
- With the TE Connectivity ADO System®, experience the fastest and most reliable connection on the market,
- Designed for control applications exposed to severe constraints (vibrations, shocks, corrosion etc.),
- Up to 2 wires per connection.

Ordering details

Description	Color	Type	Part Number	Pkg pce	Weight (1 pce) g
Feed-through	Grey	DR1.5/6.ADO	1SNA199283R2400	100	4.00
	Grey	DRE1.5/6.ADO	1SNA299554R0700	20	4.00

Main technical data

	IEC	UL	CSA	Mounting instructions
ADO	Rigid: Solid/Stranded Flexible without ferrule Flexible with insulated ferrule	0.28-1.5 mm² 0.34-1.5 mm²	22-16 AWG 22-16 AWG	Rail Wire stripping length Tool Torque
Screw clamp	Rigid: Solid/Stranded Flexible without ferrule Flexible with insulated ferrule Gauge			
Rated current / Rated cross section	17.5 A / 1.5 mm²	20 A / 16 AWG		
Rated short-time withstand current (1s)	180 A			
Rated voltage	1000 V	600 V		
Impulse withstand voltage	8000 V			
Protection	IP20	NEMA 1		

The connecting capacity data for one Rigid: Solid/Stranded, or one Flexible conductor (when applicable) is a mandatory information required by IEC, UL and CSA standards (Copper conductors). All other data are provided as supplementary information only. For more details, please consult our CB, UL or CSA certificates and technical datasheet available on <http://www.TE.com>

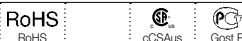

Notes

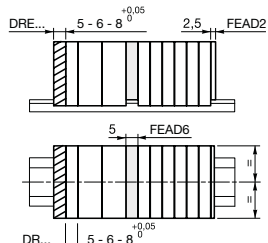

- End section FEAD1 to be mounted directly on the open part of the terminal block.
- End terminal block DRE has to be mounted at the end of the terminal blocks assembly: it reduces its size, because it suppresses the insulation rib (- 4 mm).
- Nota: This terminal block cannot be accidentally located anywhere else into the terminal block assembly (without locking holes)
- Separator FEAD5 which snaps on the terminal blocks, separates and makes visible the different parts of the terminal blocks assembly.

Accessories

Description	Color	Type	Part Number	Pkg pce	Weight (1 pce) g	
1 End stops	Grey	BADRL	1SNA199420R2100	50	2.00	
2 End sections	Grey	FEAD2	1SNA199423R1000	20	1.30	
3 Jumper bars	Orange	2 poles	BJADO6-2	1SNA205974R0600	20	1.00
		3 poles	BJADO6-3	1SNA205975R0700	20	1.00
		10 poles	BJADO6-10	1SNA205982R2700	10	6.00
4 Circuit separators	Grey	FEAD6	1SNA199435R1400	20	1.80	
5 Tools		Semi automatic tool	OUPAD	1SNA178944R0400	1	205.00
		Hand tool	OUMAD	1SNA179466R0600	1	29.00
6 Terminal block markers	White	RC65	1SNA232000R0000	1	3.60	

Complete list of accessories is indicated in the terminal block datasheet. Some accessories such as jumper bars may modify the terminal block's ratings: complete information in the accessories catalogue pages.

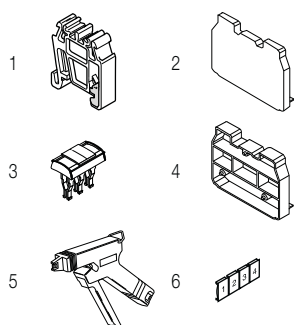

Technical data valid for copper conductors only.

DR2.5/8.ADO IDC terminal blocks

Miniblocks ADO - ADO - 8 mm 0.315 in spacing



DR2.5/8.ADO

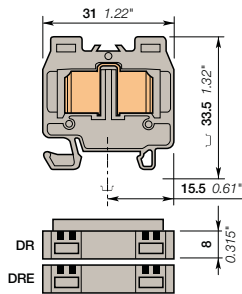

8 mm 0.315 in spacing

Description

- The mini blocks are particularly designed for applications where space is very restricted,
- With the TE Connectivity ADO System®, experience the fastest and most reliable connection on the market,
- Designed for control applications exposed to severe constrains (vibrations, shocks, corrosion etc.),
- Up to 2 wires per connection.

Ordering details

Description	Color	Type	Part Number	Pkg pce	Weight (1 pce) g
Feed-through With rib and 2 notches for wire size 1-2.5 mm ² (16-14 AWG)	Grey	<input type="checkbox"/> DR2.5/8.ADO	1SNA199287R2000	100	6.00
Without rib for TB assembly extremity and 2 notches for wire size 1-2.5 mm ² (16-14 AWG)	Grey	<input type="checkbox"/> DRE2.5/8.ADO	1SNA299555R0000	20	6.00

Main technical data

	IEC	UL	CSA	Mounting instructions		
ADO	Rigid: Solid/Stranded Flexible without ferrule Flexible with ferrule	1-2.5 mm ² 16-14 AWG	16-14 AWG	Rail		TH 15-5.5
Screw clamp	Rigid: Solid/Stranded Flexible without ferrule Flexible with insulated ferrule Gauge			Wire stripping length		
Rated current / Rated cross section	24 A / 2.5 mm ²	25 A / 14 AWG		Tool		
Rated short-time withstand current (1s)	8000 A			Torque		
Rated voltage	1000 V	600 V				
Impulse withstand voltage	8000 V					
Protection	IP20	NEMA 1				

The connecting capacity data for one Rigid: Solid/Stranded, or one Flexible conductor (when applicable) is a mandatory information required by IEC, UL and CSA standards (Copper conductors). All other data are provided as supplementary information only. For more details, please consult our CB, UL or CSA certificates and technical datasheet available on <http://www.TE.com>

RoHS							
------	--	--	--	--	--	--	--

Notes

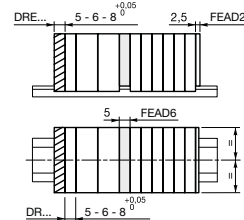

- End section FEAD1 to be mounted directly on the open part of the terminal block.
- End terminal block DRE has to be mounted at the end of the terminal blocks assembly: it reduces its size, because it suppresses the insulation rib (- 4 mm).
- Nota: This terminal block cannot be accidentally located anywhere else into the terminal block assembly (without locking holes)
- Separator FEAD5 which snaps on the terminal blocks, separates and makes visible the different parts of the terminal blocks assembly.

Accessories

Description	Color	Type	Part Number	Pkg pce	Weight (1 pce) g
1 End stops 6.5 mm 0.256 in	Grey	<input type="checkbox"/> BADRL	1SNA199420R2100	50	2.00
2 End sections 2.5 mm 0.098 in	Grey	<input type="checkbox"/> FEAD2	1SNA199423R1000	20	1.30
3 Circuit separators 5 mm 0.197 in	Grey	<input type="checkbox"/> FEAD6	1SNA199435R1400	20	1.80
4 Tools Semi automatic tool		OUPAD	1SNA178944R0400	1	205.00
Hand tool		OUMAD	1SNA179466R0600	1	29.00
5 Terminal block markers Blank card		RCAL85	1SNA237000R0500	1	2.90

Complete list of accessories is indicated in the terminal block datasheet.

Some accessories such as jumper bars may modify the terminal block's ratings: complete information in the accessories catalogue pages.

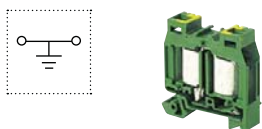
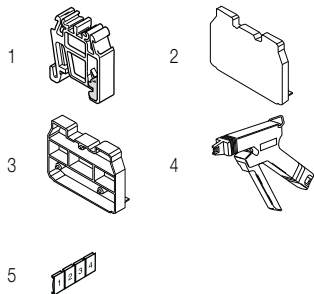

Ground IDC terminal blocks

Description	Color	Type	Part Number	Pkg pce	Weight (1 pce) g
Ground Profile aligned with DR2.5/8.ADO	Green-yellow	<input checked="" type="checkbox"/> DR2.5/8.P.ADO	1SNA299633R0600	100	8.00

Technical data valid for copper conductors only.

DR2.5/8.P.ADO IDC terminal blocks

Miniblocks ADO - ADO - 8 mm 0.315 in spacing

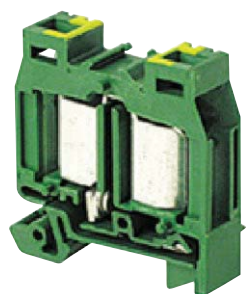

1SNC163141F0014

DR2.5/8.P.ADO

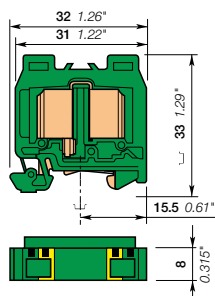

8 mm 0.315 in spacing

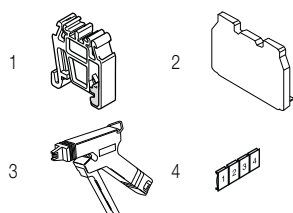

Description

- The mini blocks are particularly designed for applications where space is very restricted,
- Protect your installation in the event of a short-circuit thanks to our screwless rail contact non operator dependent,
- Secure mounting or removal from the rail,
- With the TE Connectivity ADO System®, experience the fastest and most reliable connection on the market,
- Up to 2 wires per connection.

Ordering details

Description	Color	Type	Part Number	Pkg pce	Weight (1 pce) g
Ground With 2 notches for wire size 1-2.5 mm ² (16-14 AWG)	Green-yellow	DR2.5/8.P.ADO	1SNA299633R0600	100	8.00

Main technical data

	IEC	UL	CSA	Mounting instructions		
ADO	Rigid: Solid/Stranded Flexible without ferrule	1-2.5 mm ² 1-2.5 mm ²	16-14 AWG	Rail		TH 15-5.5
Screw clamp	Rigid: Solid/Stranded Flexible without ferrule Flexible with insulated ferrule			Wire stripping length		
Rated cross section	2.5 mm ²	14 AWG		Tool		
Rated short-time withstand current (1s)	300 A			Torque		
Protection	IP20	NEMA 1				

The connecting capacity data for one Rigid: Solid/Stranded, or one Flexible conductor (when applicable) is a mandatory information required by IEC, UL and CSA standards (Copper conductors). All other data are provided as supplementary information only. For more details, please consult our CB, UL or CSA certificates and technical datasheet available on <http://www.TE.com>

RoHS						
RoHS	cCSAus	Gost R				

Accessories

Description	Color	Type	Part Number	Pkg pce	Weight (1 pce) g
1 End stops	Grey	BADRL	1SNA199420R2100	50	2.00
2 End sections	Grey	FEAD2	1SNA199423R1000	20	1.30
3 Tools		OUPAD	1SNA178944R0400	1	205.00
		OUMAD	1SNA179466R0600	1	29.00
4 Terminal block markers		RCAL85	1SNA237000R0500	1	2.90

Complete list of accessories is indicated in the terminal block datasheet.

Some accessories such as jumper bars may modify the terminal block's ratings: complete information in the accessories catalogue pages.

Technical data valid for copper conductors only.

DB1.5/6.ADO IDC terminal blocks

Miniblocks ADO - ADO - 6 mm 0.236 in spacing



DB1.5/6.ADO

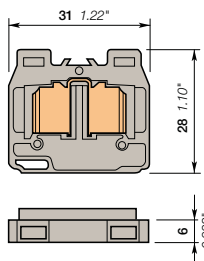

Description

- The mini blocks are particularly designed for applications where space is very restricted,
- With the TE Connectivity ADO System®, experience the fastest and most reliable connection on the market,
- Designed for control applications exposed to severe constrains (vibrations, shocks, corrosion etc.),
- Easy base mounting thanks to the usage of flanges,
- Up to 2 wires per connection.

Ordering details

Description	Color	Type	Part Number	Pkg pce	Weight (1 pce) g
Feed-through	Grey <input type="checkbox"/>	DB1.5/6.ADO	1SNA299513R2600	100	4.00

Main technical data

		IEC	UL	CSA	Mounting instructions	
ADO	Rigid: Solid/Stranded	0.28-1.5 mm²	22-16 AWG		Rail	
	Flexible without ferrule	0.34-1.5 mm²				
Screw clamp	Rigid: Solid/Stranded				Tool	
	Flexible without ferrule					
	Flexible with insulated ferrule					
Gauge					Torque	
Rated current / Rated cross section		17.5 A / 1.5 mm²	20 A / 16 AWG			
Rated short-time withstand current (1s)		180 A				
Rated voltage		1000 V	600 V			
Impulse withstand voltage		8000 V				
Protection		IP20	NEMA 1			

The connecting capacity data for one Rigid: Solid/Stranded Flexible conductor (when applicable) is a mandatory information required by IEC, UL and CSA standards (Copper conductors). All other data are provided as supplementary information only. For more details, please consult our CB, UL or CSA certificates and technical datasheet available on <http://www.TE.com>



Notes

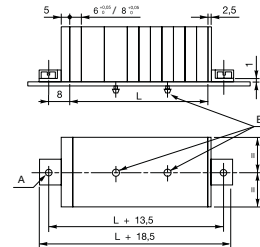

- A: 2 holes DIA 3.2 mm for 3 mm screw max. with cylindrical head (not supplied).
- $L = (N \text{ blocks} \times 6) + (N \text{ blocks} \times 8)$
- Plate thickness 0.6 to 1.2 mm
- Intermediate mounting of DH blocks every 2 blocks (spacing 8 mm) or 3 blocks (spacing 6mm)

6 mm 0.236 in spacing

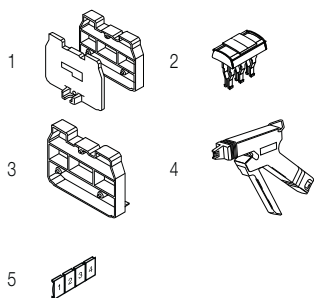

Accessories

Description	Color	Type	Part Number	Pkg pce	Weight (1 pce) g	
1 End section kits	Grey <input type="checkbox"/>	FEAD4	1SNA199439R2000	20	3.00	
2 Jumper bars	Orange <input type="checkbox"/>	2 poles 17.5 A	BJADO6-2	1SNA205974R0600	20	1.00
		3 poles	BJADO6-3	1SNA205975R0700	20	1.00
		10 poles	BJADO6-10	1SNA205982R2700	10	6.00
3 Circuit separators	Grey <input type="checkbox"/>	FEAD6	1SNA199435R1400	20	1.80	
4 Tools		Semi automatic tool	OUPAD	1SNA178944R0400	1	205.00
		Hand tool	OUMAD	1SNA179466R0600	1	29.00
5 Terminal block markers	White <input type="checkbox"/>	RC65	1SNA232000R0000	1	3.60	

Complete list of accessories is indicated in the terminal block datasheet.

Some accessories such as jumper bars may modify the terminal block's ratings: complete information in the accessories catalogue pages.

Technical data valid for copper conductors only.

DB2.5/8.ADO IDC terminal blocks

Miniblocks ADO - ADO - 8 mm 0.315 in spacing



DB2.5/8.ADO

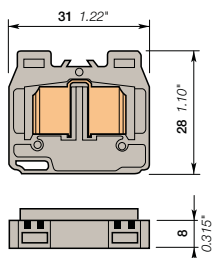

8 mm 0.315 in spacing

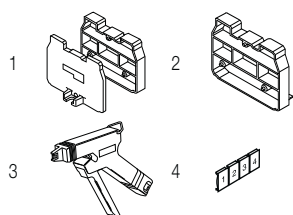

Description

- The mini blocks are particularly designed for applications where space is very restricted,
- With the TE Connectivity ADO System®, experience the fastest and most reliable connection on the market,
- Designed for control applications exposed to severe constraints (vibrations, shocks, corrosion etc.),
- Easy base mounting thanks to the usage of flanges,
- Up to 2 wires per connection.

Ordering details

Description	Color	Type	Part Number	Pkg pce	Weight (1 pce) g
Feed-through With 2 notches for wire size 1-2.5 mm ² (16-14 AWG)	Grey <input type="checkbox"/>	DB2.5/8.ADO	1SNA299517R2200	100	6.00

Main technical data

	IEC	UL	CSA	Mounting instructions
ADO	Rigid: Solid/Stranded Flexible without ferrule Flexible with insulated ferrule	1-2.5 mm ² 16-14 AWG	16-14 AWG	Wire stripping length
Screw clamp	Rigid: Solid/Stranded Flexible without ferrule Flexible with insulated ferrule			Tool
Rated current / Rated cross section	24 A / 2.5 mm ²	25 A / 14 AWG		Torque
Rated short-time withstand current (1s)	300 A			
Rated voltage	800 V	600 V		
Impulse withstand voltage	8000 V			
Protection	IP20	NEMA 1		

The connecting capacity data for one Rigid: Solid/Stranded, or one Flexible conductor (when applicable) is a mandatory information required by IEC, UL and CSA standards (Copper conductors). All other data are provided as supplementary information only. For more details, please consult our CB, UL or CSA certificates and technical datasheet available on <http://www.TE.com>



Notes

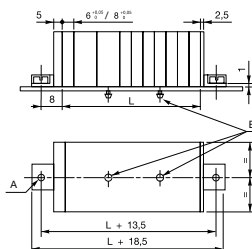

- A: 2 holes DIA 3.2 mm for 3 mm screw max. with cylindrical head (not supplied).
- L = (N blocks x 6) + (N blocks x 8)
- Plate thickness 0.6 to 1.2 mm
- Intermediate mounting of DH blocks every 2 blocks (spacing 8 mm) or 3 blocks (spacing 6 mm)

Accessories

Description	Color	Type	Part Number	Pkg pce	Weight (1 pce) g
1 End section kits	Grey <input type="checkbox"/>	FEAD4	1SNA199439R2000	20	3.00
2 Circuit separators 5 mm 0.197 in	Grey <input type="checkbox"/>	FEAD6	1SNA199435R1400	20	1.80
3 Tools Semi automatic tool		OUPAD	1SNA178944R0400	1	205.00
Hand tool		OUMAD	1SNA179466R0600	1	29.00
4 Terminal block markers Blank card		RCAL85	1SNA237000R0500	1	2.90

Complete list of accessories is indicated in the terminal block datasheet. Some accessories such as jumper bars may modify the terminal block's ratings: complete information in the accessories catalogue pages.

Technical data valid for copper conductors only.

DH1.5/6.ADO IDC terminal blocks

Miniblocks ADO - ADO - 6 mm 0.236 in spacing



DH1.5/6.ADO

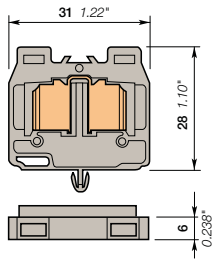

6 mm 0.236 in spacing

Description

- The mini blocks are particularly designed for applications where space is very restricted,
- With the TE Connectivity ADO System®, experience the fastest and most reliable connection on the market,
- Designed for control applications exposed to severe constrains (vibrations, shocks, corrosion etc.),
- Easy base mounting thanks to snap in mounting foot,
- Up to 2 wires per connection.

Ordering details

Description	Color	Type	Part Number	Pkg pce	Weight (1 pce) g
Feed-through	Grey <input type="checkbox"/>	DH1.5/6.ADO	1SNA299529R0600	100	4.00

Main technical data

		IEC	UL	CSA	Mounting instructions	
ADO	Rigid: Solid/Stranded	0.28-1.5 mm²	22-16 AWG		Wire stripping length	
	Flexible without ferrule	0.34-1.5 mm²				
Screw clamp	Rigid: Solid/Stranded				Tool	
	Flexible without ferrule					
	Flexible with insulated ferrule					
Gauge					Torque	
Rated current / Rated cross section		17.5 A / 1.5 mm²	20 A / 16 AWG			
Rated short-time withstand current (1s)		180 A				
Rated voltage		1000 V	600 V			
Impulse withstand voltage		8000 V				
Protection		IP20	NEMA 1			

The connecting capacity data for one Rigid: Solid/Stranded, or one Flexible conductor (when applicable) is a mandatory information required by IEC, UL and CSA standards (Copper conductors). All other data are provided as supplementary information only. For more details, please consult our CB, UL or CSA certificates and technical datasheet available on <http://www.TE.com>

RoHS			
RoHS			

Notes

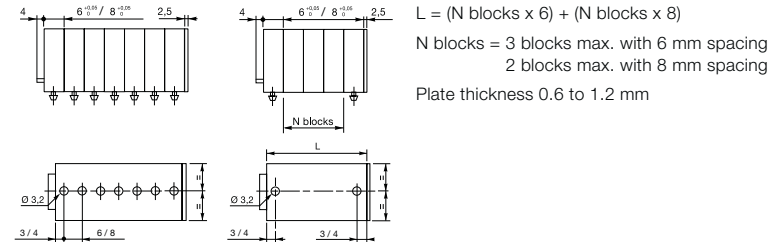

Accessories

Description	Color	Type	Part Number	Pkg pce	Weight (1 pce) g	
1 End sections	Grey <input type="checkbox"/>	FEAD2	1SNA199423R1000	20	1.30	
2 Jumper bars	Orange <input type="checkbox"/>	2 poles	BJADO6-2	1SNA205974R0600	20	1.00
		3 poles	BJADO6-3	1SNA205975R0700	20	1.00
		10 poles	BJADO6-10	1SNA205982R2700	10	6.00
3 Circuit separators	Grey <input type="checkbox"/>	FEAD6	1SNA199435R1400	20	1.80	
4 Tools		Semi automatic tool	OUPAD	1SNA178944R0400	1	205.00
		Hand tool	OUMAD	1SNA179466R0600	1	29.00
		Terminal block markers	Blank card	White <input type="checkbox"/> RC65	1SNA232000R0000	1

Complete list of accessories is indicated in the terminal block datasheet. Some accessories such as jumper bars may modify the terminal block's ratings: complete information in the accessories catalogue pages.

Technical data valid for copper conductors only.



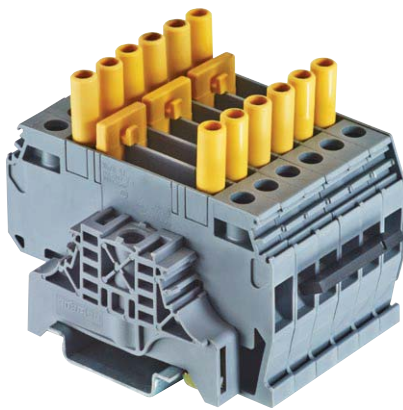

Dedicated applications terminal blocks

Test & measurement

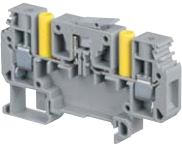
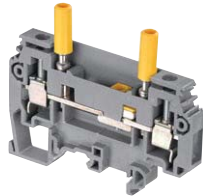

Technologies presentation	154
Overview	156

Screw clamp technology

Test disconnect with screwdriver sliding link

6 mm ² / 8 AWG	M6/8.ST		157
	M6/8.ST1	With test	158
	M6/8.ST1.IP20	With insulated test sockets	159
	M6/8.ST3	With insulated rod	160
	M6/8.ST7	Feed-through	161
	M6/8.STA	With test	162

Test disconnect with blade

6 mm ² / 8 AWG	D6/10.SNBTB1		163
	D6/10.SNBTB2	With test	164

Test disconnect with plug

4 mm ² / 12 AWG	M4/6.ST		165
10 mm ² / 8 AWG	M10/10.ST-Sn		166

Test disconnect with push-turn knob

6 mm ² / 8 AWG	M6/8.STP1	with test	167
	M6/8.STP	with test	168

Spring loaded screw clamp technology

Test disconnect with screwdriver sliding link

6 mm ² / 12 AWG	D6/8.ST1.RS	With test	169
	D6/8.ST1.RS.IP20	With insulated test sockets	170

Dedicated applications terminal blocks

Test & measurement - Screw clamp technology

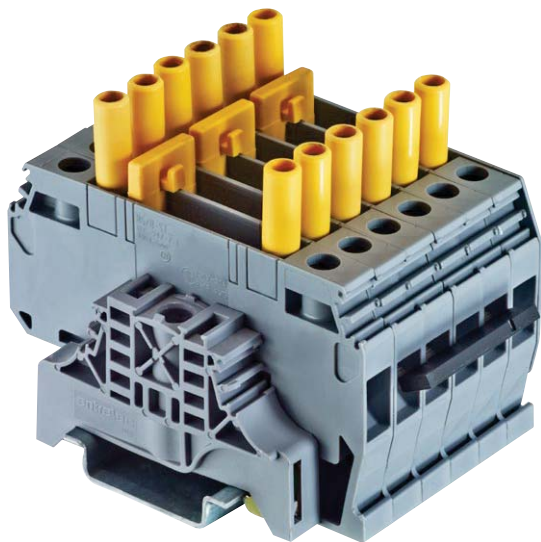

Secure your measurement operations

Our test & measurement terminal blocks benefit from our long experience in the energy applications. A large choice of accessories make the test & measurement operation easy and secure.

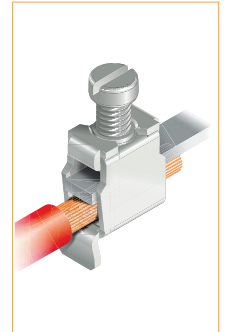

RoHS

ISO 9001
ISO 14001



A large choice of combinations and accessories

Short-circuit CT circuits safely and conveniently

TE connectivity's insulated short-circuit bridge allows secured short-circuit position thanks to AJS9 test sockets tightening.

Adapted hook shape maintains the bridge on terminal block in the non connected position.

Test your circuits with flexibility using AJS9 test sockets

The insulated test sockets AJS9 are available in 6 colors for convenient circuit identification.

They are compatible with standard DIA. 4 mm test plugs (IEC 60010-031).

Fully operated by screwdriver (DIA. 3.5 mm).

Convenient circuit distribution with lateral jumpers

TE Connectivity provides a whole set of lateral jumpers adapted to the various circuit configurations of our customers.

Secure your disconnect operation during short-circuiting

In non short-circuited position:

The short circuiting bridge is opened. For security purpose, the access to the disconnect sliding unit is blocked (in closed position).

In short-circuited position:

The short circuiting bridge is first positioned, authorizing access to the disconnect sliding unit for opening the circuit.

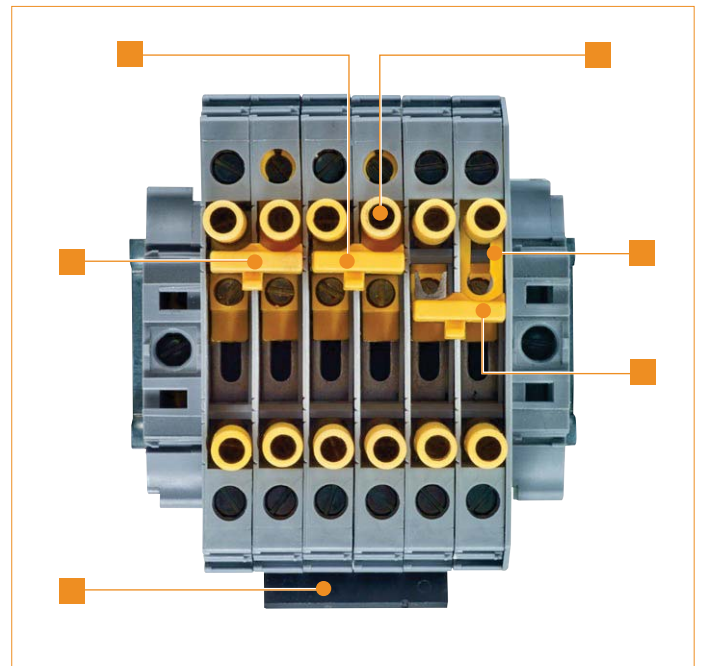

1SNC161164S0201

Dedicated applications terminal blocks

Test & measurement - Typical schematic for measuring devices

Common point on the transformers

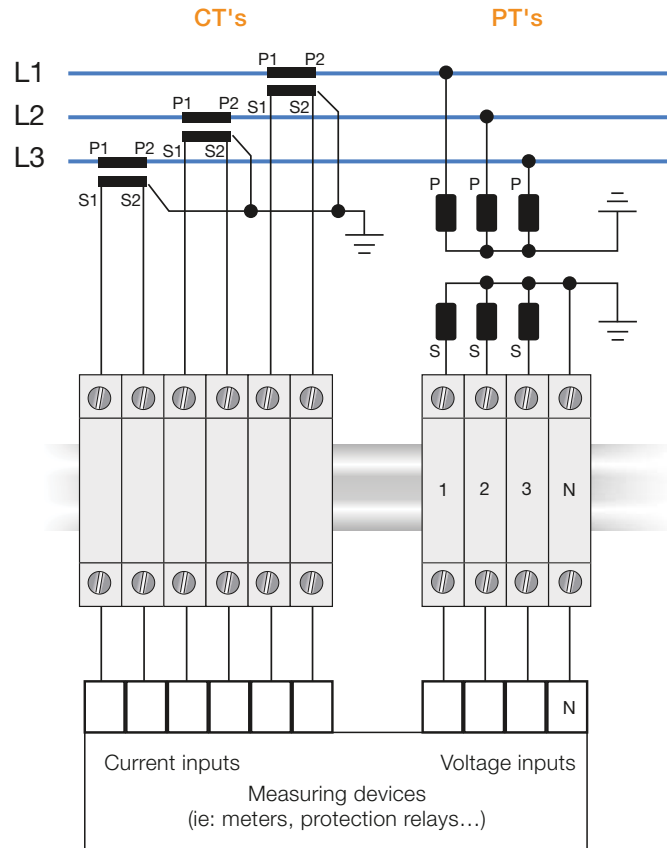

Dedicated applications terminal blocks

Test & measurement

Screw clamp technology



Test disconnect with screwdriver sliding link

Test disconnect with insulated rod sliding link

Feed-through

Test disconnect with screwdriver sliding link

Section

IEC	UL/CSA				
6 mm ²	8 AWG	M6/8.ST 6 mm 0.236 in	M6/8.ST1.IP20 6 mm 0.236 in	M6/8.ST3 8 mm 0.315 in	M6/8.ST7 8 mm 0.315 in



Test disconnect with blade

Test disconnect with plug

Test disconnect with push-turn knob

Section

IEC	UL/CSA				
4 mm ²	12 AWG		M4/6.ST 6 mm 0.236 in		
6 mm ²	8 AWG	D6/10.SNBTB 10 mm 0.394 in	M10/10.ST-Sn 10 mm 0.394 in	M6/8.STP1 8 mm 0.315 in	M6/8.STP 8 mm 0.315 in

Spring loaded screw clamp technology



Test disconnect with screwdriver sliding link

Section

IEC	UL/CSA	
6 mm ²	12 AWG	D6/8.ST1.RS.IP20 8 mm 0.315 in

M6/8.ST screw clamp terminal blocks

Test disconnect with a screwdriver sliding link - 8 mm 0.315 in spacing



M6/8.ST

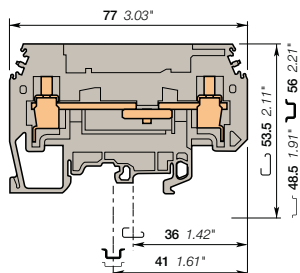

8 mm 0.315 in spacing

Description

Secure your disconnect operations with the disconnect sliding link operated with a screwdriver.

Ordering details

Description	Color	Type	Part Number	Pkg pce	Weight (1 pce) g
Disconnect	Grey	M6/8.ST	1SNA115236R1700	25	30.00

Main technical data

	IEC	UL	CSA
1 conductor per clamp	Rigid: Solid/Stranded Flexible without ferrule Flexible with insulated ferrule Gauge	0.5-10 mm ² 0.5-6 mm ² A5	18 - 8 AWG 18-8 AWG
Rated current / Rated cross section	40 A / 6 mm ²	30 A / 8 AWG	30 A / 8 AWG
Rated short-time withstand current (1s)	720 A		
Rated voltage	630 V	150 V	150 V
Impulse withstand voltage			
Protection	IP20	NEMA 1	

Mounting instructions

Rail		G32, TH 35-7.5, TH 35-15
Wire stripping length		13 mm 0.51 in
Screw clamp Tool		Flat screwdriver Ø 5 mm Ø 0.197 in
Torque		0.8 - 1 N.m 7.1 - 8.9 lb.in
Disconnect device Tool		Flat screwdriver Ø 3.5 mm Ø 0.138 in
Torque		0.4 - 0.6 N.m 3.5 - 5.3 lb.in

The connecting capacity data for one Rigid: Solid/Stranded, or one Flexible conductor (when applicable) is a mandatory information required by IEC, UL and CSA standards (Copper conductors). All other data are provided as supplementary information only. For more details, please consult our CB, UL or CSA certificates and technical datasheet available on <http://www.TE.com>

CE	RoHS	UR	CSA	Gost R

Accessories

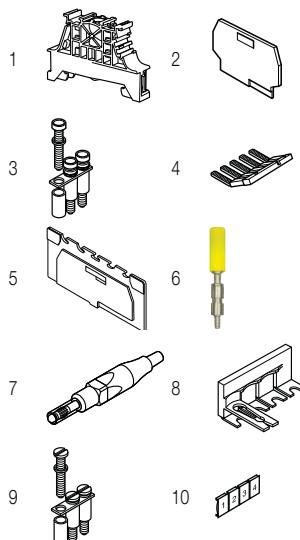

Description	Color	Type	Part Number	Pkg pce	Weight (1 pce) g
1 End stops	Dark grey	BAM4	1SNK900001R0000	50	14.00
		BAZ1	1SNK900002R0000	50	5.30
2 End sections	Grey	FEMT2	1SNA113629R2700	10	2.00
3 Jumper bars		BJS8-20	1SNA174789R0500	5	3.20
4 Lateral jumper bars 50 A	Black	PC8-10	1SNA163313R2400	10	14.00
		PC8-R1	1SNA400711R0600	10	6.60
		PC8-R2	1SNA400712R0700	10	7.84
		PC8-R3	1SNA400713R0000	10	9.00
		PC8-R4	1SNA400724R0300	10	4.50
5 Circuit separators	Grey	SCFT2	1SNA114522R0500	20	
6 Test sockets	Yellow	AJS9	1SNA179726R0200	25	5.00
	Black	AJS9-1	1SNA206680R1500	25	3.60
	Green	AJS9-2	1SNA206681R0200	25	3.60
	Grey	AJS9-3	1SNA206682R0300	25	3.60
	Blue	AJS9-4	1SNA206683R0400	25	3.60
	Red	AJS9-5	1SNA206720R1400	25	3.60
		AL4-M3	1SNA206721R0100	50	1.10
7 Test plugs	Red	FC4-1	1SNA167927R1000	10	11.00
8 Short circuit bridges	Yellow	SC-JB8-2	1SNK900652R0000	25	2.00
		SC-JB8-3	1SNK900653R0000	25	3.40
		SC-JB8-4	1SNK900654R0000	25	4.70
9 Fastening kits		Sub assembly post + screw + washer	EV8S	20	3.00
10 Terminal block markers	White	Blank card	RC810	1	8.20

Complete list of accessories is indicated in the terminal block datasheet. Some accessories such as jumper bars may modify the terminal block's ratings: complete information in the accessories catalogue pages.

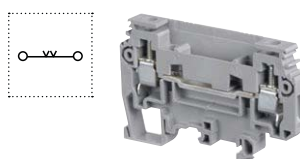

Feed-through screw clamp terminal blocks

Description	Color	Type	Part Number	Pkg pce	Weight (1 pce) g
Feed-through	Grey	M6/8.ST7	1SNA115243R2600	25	20.00

Technical data valid for copper conductors only.

M6/8.ST screw clamp terminal blocks

Test disconnect with a screwdriver sliding link - 8 mm 0.315 in spacing

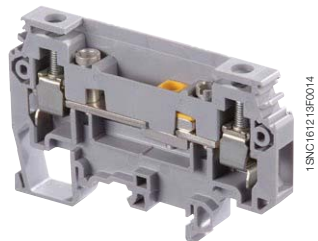

M6/8.ST

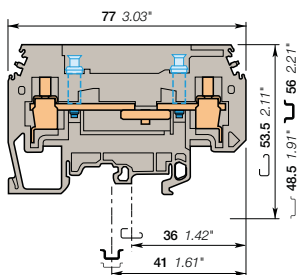

8 mm 0.315 in spacing

Description

- Secure your disconnect operations with the disconnect sliding link operated with a screwdriver,
- Ease your test operations with the 2 independent built-in test sockets compatible with DIA 4 mm 0.157 in test plugs.

Ordering details

Description	Color	Type	Part Number	Pkg pce	Weight (1 pce) g
Disconnect With 2 test sockets DIA 4 mm 0.157 in	Grey <input type="checkbox"/>	M6/8.ST1	1SNA115237R1000	25	30.00

Main technical data

	IEC	UL	CSA
1 conductor per clamp	Rigid: Solid/Stranded Flexible without ferrule Flexible with insulated ferrule Gauge	0.5-10 mm ² 0.5-6 mm ² A5	18 - 8 AWG 18-8 AWG
Rated current / Rated cross section	40 A / 6 mm ²	30 A / 8 AWG	30 A / 8 AWG
Rated short-time withstand current (1s)	720 A		
Rated voltage	630 V	150 V	150 V
Impulse withstand voltage		NEMA	
Protection			

Mounting instructions

Rail		G32, TH 35-7.5, TH 35-15
Wire stripping length		13 mm 0.51 in
Screw clamp Tool		Flat screwdriver Ø 5 mm Ø 0.197 in
Torque		0.8 - 1 N.m 7.1 - 8.9 lb.in
Disconnect device Tool		Flat screwdriver Ø 3.5 mm Ø 0.138 in
Torque		0.4 - 0.6 N.m 3.5 - 5.3 lb.in

The connecting capacity data for one Rigid: Solid/Stranded, or one Flexible conductor (when applicable) is a mandatory information required by IEC, UL and CSA standards (Copper conductors). All other data are provided as supplementary information only. For more details, please consult our CB, UL or CSA certificates and technical datasheet available on <http://www.TE.com>

CE	RoHS	UL	CSA	Gost R						

Accessories

Description	Color	Type	Part Number	Pkg pce	Weight (1 pce) g
1 End stops 10 mm 0.394 in	Dark grey <input type="checkbox"/>	BAM4	1SNK900001R0000	50	14.00
9 mm 0.354 in		BAZ1	1SNK900002R0000	50	4.70
2 End sections 1 mm 0.039 in	Grey <input type="checkbox"/>	FEMT2	1SNA113629R2700	10	2.00
3 Lateral jumper bars 50 A	Black <input type="checkbox"/>	PC8-10	1SNA163313R2400	10	14.00
		PC8-R1	1SNA400711R0600	10	6.60
		PC8-R2	1SNA400712R0700	10	7.84
		PC8-R3	1SNA400713R0000	10	9.00
		PC8-R4	1SNA400724R0300	10	4.50
4 Circuit separators 3 mm 0.118 in	Grey <input type="checkbox"/>	SCFT2	1SNA114522R0500	20	
5 Test plugs DIA 4 mm 0.157 in IP20	Red <input type="checkbox"/>	FC4-1	1SNA167927R1000	10	11.00
6 Short circuit plugs DIA 4 mm 0.157 in		BP8.A4	1SNA173888R2000	10	
7 Terminal block markers Blank card	White <input type="checkbox"/>	RC810	1SNA234000R0200	1	8.20

Complete list of accessories is indicated in the terminal block datasheet. Some accessories such as jumper bars may modify the terminal block's ratings: complete information in the accessories catalogue pages.

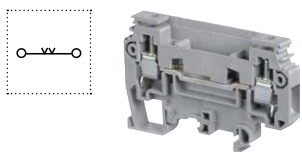
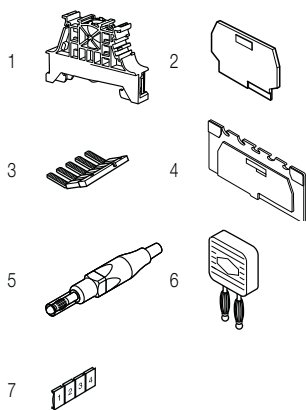

Feed-through screw clamp terminal blocks

Description	Color	Type	Part Number	Pkg pce	Weight (1 pce) g
Feed-through Profile aligned with M6/8.ST...	Grey <input type="checkbox"/>	M6/8.ST7	1SNA115243R2600	25	20.00

Technical data valid for copper conductors only.

M6/8.ST screw clamp terminal blocks

Test disconnect with a screwdriver sliding link - 8 mm 0.315 in spacing

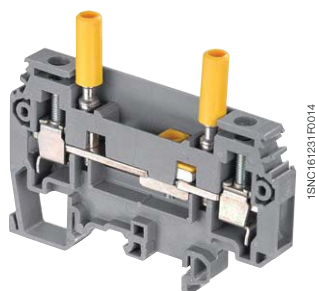

M6/8.ST

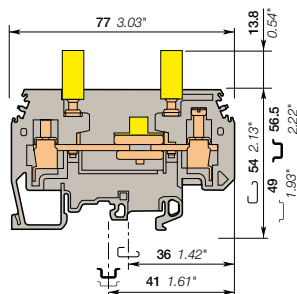

8 mm 0.315 in spacing

Description

- Terminal blocks especially designed for current transformers circuits:
- Easy and secured current measurement thanks to the two built-in test yellow sockets compatible with IP20 DIA 4 mm 0.157 in test plugs,
- Convenient short-circuit operations with the PCS sliding short circuiting bridges from 2 to 4 poles,
- Tests sockets available as well in black, green, grey and blue.

Ordering details

Description	Color	Type	Part Number	Pkg pce	Weight (1 pce) g
Disconnect With two yellow test sockets DIA 4 mm 0.157 in	Grey <input type="checkbox"/>	M6/8.ST1.IP20	1SNA115971R1000	25	40.00

Main technical data

	IEC	UL	CSA	Mounting instructions	
1 conductor per clamp	Rigid: Solid/Stranded Flexible without ferrule Flexible with insulated ferrule Gauge	0.5 - 10 mm ² 0.5 - 6 mm ² A5	18 - 8 AWG	18 - 8 AWG	Rail G32, TH 35-7.5, TH 35-15 Wire stripping length 13 mm 0.51 in Screw clamp Tool Flat screwdriver Ø 3.5 mm Ø 0.138 in Torque 0.8 - 1 N.m 7.1 - 8.9 lb.in
Rated current / Rated cross section	40 A / 6 mm ²	30 A / 8 AWG	30 A / 8 AWG	Disconnect device Tool Flat screwdriver Ø 3.5 mm Ø 0.138 in Torque 0.5 N.m 4.45 lb.in Test socket Tool Flat screwdriver Ø 3.5 mm Ø 0.138 in Torque 0.6 N.m 5.34 lb.in	
Rated short-time withstand current (1s)	720 A				
Rated voltage	630 V	150 V	150 V		
Impulse withstand voltage	8000 V				
Protection	IP20	NEMA 1			

The connecting capacity data for one Rigid: Solid/Stranded, or one Flexible conductor (when applicable) is a mandatory information required by IEC, UL and CSA standards (Copper conductors). All other data are provided as supplementary information only. For more details, please consult our CB, UL or CSA certificates and technical datasheet available on <http://www.TE.com>

CE	RoHS	USA	CSA	PG
CE	RoHS	USR	CSA	Gost R

Accessories

Description	Color	Type	Part Number	Pkg pce	Weight (1 pce) g
1 End stops	Dark grey <input type="checkbox"/>	BAM4	1SNK900001R0000	50	14.00
		BAZ1	1SNK900002R0000	50	4.70
2 End sections	Grey <input type="checkbox"/>	FEMT2	1SNA113629R2700	10	2.00
3 Lateral jumper bars 50 A	Black <input type="checkbox"/>	PC8-10	1SNA163313R2400	10	14.00
		PC8-R1	1SNA400711R0600	10	6.60
		PC8-R2	1SNA400712R0700	10	7.84
		PC8-R3	1SNA400713R0000	10	9.00
		PC8-R4	1SNA400724R0300	10	4.50
4 Test sockets	Black <input type="checkbox"/>	AJS9-1	1SNA206680R1500	25	3.60
	Green <input type="checkbox"/>	AJS9-2	1SNA206681R0200	25	3.60
	Grey <input type="checkbox"/>	AJS9-3	1SNA206682R0300	25	3.60
	Blue <input type="checkbox"/>	AJS9-4	1SNA206683R0400	25	3.60
	Red <input type="checkbox"/>	AJS9-5	1SNA206720R1400	25	3.60
5 Test plugs	Red <input type="checkbox"/>	FC4-1	1SNA167927R1000	10	11.00
6 Short circuit bridges	Yellow <input type="checkbox"/>	SC-JB8-2	1SNK900652R0000	25	2.00
		SC-JB8-3	1SNK900653R0000	25	3.40
		SC-JB8-4	1SNK900654R0000	25	4.70
7 Terminal block markers	White <input type="checkbox"/>	RC810	1SNA234000R0200	1	8.20

Complete list of accessories is indicated in the terminal block datasheet.

Some accessories such as jumper bars may modify the terminal block's ratings: complete information in the accessories catalogue pages.

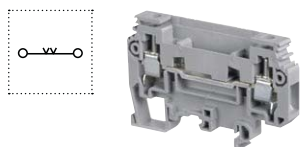

Feed-through screw clamp terminal blocks

Description	Color	Type	Part Number	Pkg pce	Weight (1 pce) g
Feed-through Profile aligned with M6/8.ST...	Grey <input type="checkbox"/>	M6/8.ST7	1SNA115243R2600	25	20.00

Technical data valid for copper conductors only.

M6/8.ST screw clamp terminal blocks

Test disconnect with insulated rod sliding link - 8 mm 0.315 in spacing



6 mm²
8 AWG

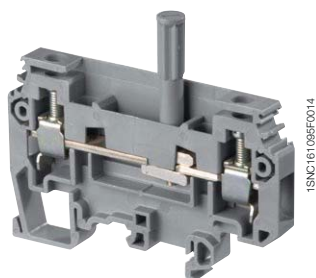

1SNM161065FC014

M6/8.ST

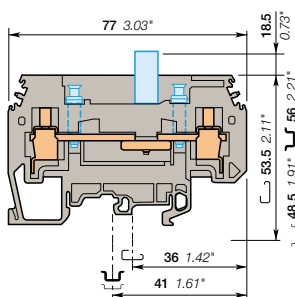

8 mm 0.315 in spacing

Description

- Secure your disconnect operations with the disconnect sliding link operated with a screwdriver,
- Ease your test operations with the two independent built-in test sockets compatible with DIA 4 mm 0.157 in test plugs.

Ordering details

Description	Color	Type	Part Number	Pkg pce	Weight (1 pce) g
Disconnect With 2 test sockets DIA 4 mm 0.157 in	Grey <input type="checkbox"/>	M6/8.ST3	1SNA115239R2200	25	30.00

Main technical data

	IEC	UL	CSA
1 conductor per clamp	Rigid: Solid/Stranded	0.5-10 mm ²	18 - 8 AWG
	Flexible without ferrule	0.5-6 mm ²	
	Flexible with insulated ferrule		
	Gauge	A5	
Rated current / Rated cross section	40 A / 6 mm ²	30 A / 8 AWG	30 A / 8 AWG
Rated short-time withstand current (1s)	720 A		
Rated voltage	630 V	150 V	150 V
Impulse withstand voltage			
Protection		NEMA	

Mounting instructions

Rail		G32, TH 35-7.5, TH 35-15
Wire stripping length		
Screw clamp Tool		Flat screwdriver Ø 5 mm Ø 0.197 in
Torque		0.8 - 1 N.m 7.1 - 8.9 lb.in
Disconnect device: Tool		Flat screwdriver Ø 3.5 mm Ø 0.138 in
Torque		0.4 - 0.6 N.m 3.5 - 5.3 lb.in

The connecting capacity data for one Rigid: Solid/Stranded, or one Flexible conductor (when applicable) is a mandatory information required by IEC, UL and CSA standards (Copper conductors). All other data are provided as supplementary information only. For more details, please consult our CB, UL or CSA certificates and technical datasheet available on <http://www.TE.com>

CE	RoHS	USR	CSA	Gost R
CE	RoHS	USR	CSA	Gost R

Accessories

Description	Color	Type	Part Number	Pkg pce	Weight (1 pce) g
1 End stops 10 mm 9 mm	Dark grey <input type="checkbox"/>	BAM4	1SNK900001R0000	50	14.00
		BAZ1	1SNK900002R0000	50	4.70
2 End sections 1 mm 0.039 in	Grey <input type="checkbox"/>	FEMT2	1SNA113629R2700	10	2.00
3 Lateral jumper bars 50 A	Black <input type="checkbox"/>	PC8-10	1SNA163313R2400	10	14.00
		PC8-R1	1SNA400711R0600	10	6.60
		PC8-R2	1SNA400712R0700	10	7.84
		PC8-R3	1SNA400713R0000	10	9.00
		PC8-R4	1SNA400724R0300	10	4.50
4 Circuit separators 3 mm 0.118 in	Grey <input type="checkbox"/>	SCFT2	1SNA114522R0500	20	
5 Test plugs DIA 4 mm 0.157 in IP20	Red <input type="checkbox"/>	FC4-1	1SNA167927R1000	10	11.00
6 Short circuit plugs DIA 4 mm 0.157 in		BP8.A4	1SNA173888R2000	10	
7 Terminal block markers Blank card	White <input type="checkbox"/>	RC810	1SNA234000R0200	1	8.20

Complete list of accessories is indicated in the terminal block datasheet.
Some accessories such as jumper bars may modify the terminal block's ratings: complete information in the accessories catalogue pages.

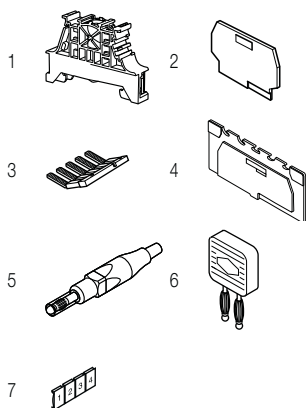

Feed-through screw clamp terminal blocks

Description	Color	Type	Part Number	Pkg pce	Weight (1 pce) g
Feed-through Profile aligned with M6/8.ST...	Grey <input type="checkbox"/>	M6/8.ST7	1SNA115243R2600	25	20.00

Technical data valid for copper conductors only.

M6/8.ST screw clamp terminal blocks

Feed-through - 8 mm 0.315 in spacing

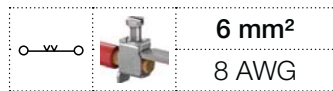

M6/8.ST

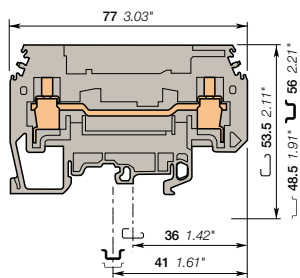

8 mm 0.315 in spacing

Description

Profile aligned with M6/8 ST.

Ordering details

Description	Color	Type	Part Number	Pkg pce	Weight (1 pce) g
Feed-through	Grey <input type="checkbox"/>	M6/8.ST7	1SNA115243R2600	25	20.00

Main technical data

		IEC	UL	CSA
1 conductor per clamp	Rigid: Solid/Stranded	0.5-10 mm ²	18 - 8 AWG	18-8 AWG
	Flexible without ferrule	0.5-6 mm ²		
	Flexible with insulated ferrule			
	Gauge	A5		
Rated current / Rated cross section		40 A / 6 mm ²	40 A / 8 AWG	40 A / 8 AWG
Rated short-time withstand current (1s)		720 A		
Rated voltage		630 V	150 V	150 V
Impulse withstand voltage				
Protection			NEMA	

Mounting instructions

Rail		G32, TH 35-7.5, TH 35-15
Wire stripping length		13 mm 0.51 in
Tool		Flat screwdriver Ø 5 mm Ø 0.197 in
Torque		0.8 - 1 N.m 7.1 - 8.9 lb.in

The connecting capacity data for one Rigid: Solid/Stranded, or one Flexible conductor (when applicable) is a mandatory information required by IEC, UL and CSA standards (Copper conductors). All other data are provided as supplementary information only. For more details, please consult our CB, UL or CSA certificates and technical datasheet available on <http://www.TE.com>

CE	RoHS	UR	CSA	Gost R

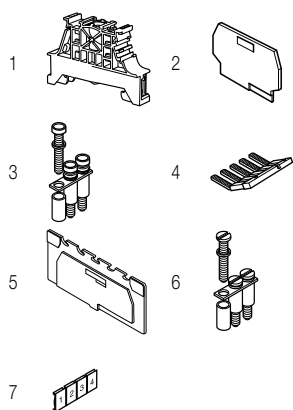

Accessories

Description	Color	Type	Part Number	Pkg pce	Weight (1 pce) g	
1 End stops	Dark grey <input type="checkbox"/>	BAM4	1SNK900001R0000	50	14.00	
		BAZ1	1SNK900002R0000	50	4.70	
2 End sections	Grey <input type="checkbox"/>	FEMT2	1SNA113629R2700	10	2.00	
3 Jumper bars		BJS8-20	1SNA174789R0500	5	3.20	
4 Lateral jumper bars	Black <input type="checkbox"/>	2 poles	PC8-2	1SNA116538R1700	10	3.00
		3 poles	PC8-3	1SNA116539R1000	10	4.00
		4 poles	PC8-4	1SNA116540R2500	10	6.00
		10 poles	PC8-10	1SNA163313R2400	10	14.00
			PC8-R1	1SNA400711R0600	10	6.60
			PC8-R2	1SNA400712R0700	10	7.84
			PC8-R3	1SNA400713R0000	10	9.00
	PC8-R4	1SNA400724R0300	10	4.50		
5 Circuit separators	Grey <input type="checkbox"/>	SCFT2	1SNA114522R0500	20		
6 Fastening kits		EV8S	1SNA168401R0300	20	3.00	
7 Terminal block markers	White <input type="checkbox"/>	RC810	1SNA234000R0200	1	8.20	

Complete list of accessories is indicated in the terminal block datasheet.

Some accessories such as jumper bars may modify the terminal block's ratings: complete information in the accessories catalogue pages.

Technical data valid for copper conductors only.

M6/8.ST screw clamp terminal blocks

Test disconnect with a screwdriver sliding link - 8 mm 0.315 in spacing

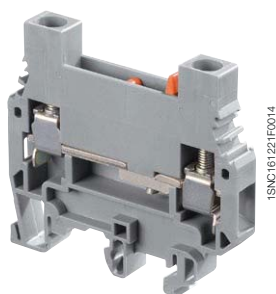

M6/8.ST

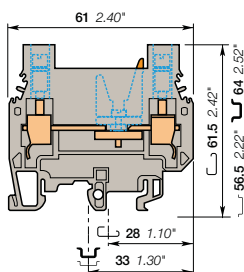

8 mm 0.315 in spacing

Description

- Compact disconnect terminal blocks:
- Secure your disconnect operations with the disconnect orange sliding link operated with a screwdriver,
- Ease your test operations with the two built-in test sockets screws compatible with DIA 4 mm 0.157 in test plugs.

Ordering details

Description	Color	Type	Part Number	Pkg pce	Weight (1 pce) g
Disconnect With 2 test sockets DIA 4 mm 0.157 in	Grey <input type="checkbox"/>	M6/8.STA	1SNA115359R0200	25	30.00

Main technical data

	IEC	UL	CSA
1 conductor per clamp			
Rigid: Solid/Stranded	0.5-10 mm ²	22 - 8 AWG	
Flexible without ferrule	0.5-6 mm ²		
Flexible with insulated ferrule			
Gauge	A5		
Rated current / Rated cross section	30 A / 6 mm ²	50 A / 8 AWG	
Rated short-time withstand current (1s)	480 A		
Rated voltage	500 V	600 V	
Impulse withstand voltage			
Protection	IP20	NEMA 1	

Mounting instructions

Rail		G32, TH 35-7.5, TH 35-15
Wire stripping length		11 mm 0.43 in
Screw clamp Tool		Flat screwdriver Ø 5.5 mm Ø 0.217 in
Torque		0.8 - 1 N.m 7.1 - 8.9 lb.in
Disconnect device Tool		Flat screwdriver Ø 4 mm Ø 0.157 in
Torque		0.4 - 0.6 N.m 3.5 - 5.3 lb.in

The connecting capacity data for one Rigid: Solid/Stranded, or one Flexible conductor (when applicable) is a mandatory information required by IEC, UL and CSA standards (Copper conductors). All other data are provided as supplementary information only. For more details, please consult our CB, UL or CSA certificates and technical datasheet available on <http://www.TE.com>

CE	RoHS: RoHS	UR	Gost R
----	------------	----	--------

Accessories

Description	Color	Type	Part Number	Pkg pce	Weight (1 pce) g
1 End stops	Dark grey <input checked="" type="checkbox"/>	BAM4	1SNK900001R0000	50	14.00
		BAZ1	1SNK900002R0000	50	4.70
2 End sections	Grey <input type="checkbox"/>	FEMT4	1SNA114778R0500	10	5.60
		FEMSTA	1SNA116979R2100	10	3.60
3 Jumper bars	Grey <input type="checkbox"/>	AD2.5	1SNA114205R2000	50	1.60
4 Lateral jumper bars	Black <input checked="" type="checkbox"/>	PC8-2	1SNA116538R1700	10	3.00
		PC8-3	1SNA116539R1000	10	4.00
		PC8-4	1SNA116540R2500	10	6.00
		PC8-10	1SNA163313R2400	10	14.00
5 Test plugs	Red <input checked="" type="checkbox"/>	FC4-1	1SNA167927R1000	10	11.00
6 Short circuit plugs		BP8.A4	1SNA173888R2000	10	
7 Terminal block markers	White <input type="checkbox"/>	RC810	1SNA234000R0200	1	8.20

Complete list of accessories is indicated in the terminal block datasheet. Some accessories such as jumper bars may modify the terminal block's ratings: complete information in the accessories catalogue pages.

7

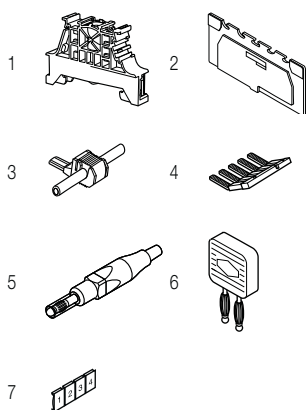

Technical data valid for copper conductors only.

D6/10.SNBTB screw clamp terminal blocks

Test disconnect with blade - 10 mm 0.394 in spacing



6 mm²



D6/10.SNBTB

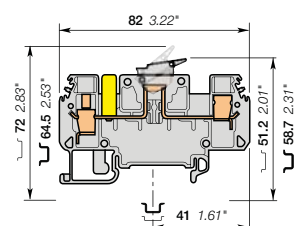

Description

- Ease your disconnect operations with the disconnect blade,
- Ease your test operations with built-in test sockets compatible with DIA 4 mm 0.157 in test plugs.

Ordering details

Description	Color	Type	Part Number	Pkg pce	Weight (1 pce) g
Disconnect With 1 isolated test socket DIA 4 mm 0.157 in	Grey <input type="checkbox"/>	D6/10.SNBTB1	1SNA115928R1500	20	25.00

Main technical data

		IEC	UL	CSA
1 conductor per clamp	Rigid: Solid/Stranded	0.5-10 mm ²		
	Flexible without ferrule	0.5-6 mm ²		
	Flexible with insulated ferrule			
	Gauge	A5		
Rated current / Rated cross section		15 A / 6 mm ²		
Rated short-time withstand current (1s)		720 A		
Rated voltage		500 V		
Impulse withstand voltage		6000 V		
Protection		IP20	NEMA 1	

Mounting instructions

Rail		G32, TH 35-7.5, TH 35-15
Wire stripping length		12 mm 0.47 in
Tool		Flat screwdriver Ø 4 mm Ø 0.157 in
Torque		0.8 N.m 7.1 lb.in

The connecting capacity data for one Rigid: Solid/Stranded, or one Flexible conductor (when applicable) is a mandatory information required by IEC, UL and CSA standards (Copper conductors). All other data are provided as supplementary information only. For more details, please consult our CB, UL or CSA certificates and technical datasheet available on <http://www.TE.com>

--	--	--	--	--	--	--	--	--	--	--

10 mm 0.394 in spacing

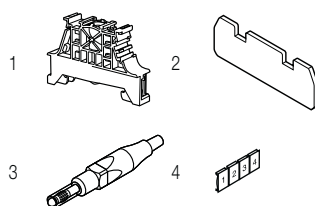

Accessories

Description	Color	Type	Part Number	Pkg pce	Weight (1 pce) g
1 End stops	Dark grey <input type="checkbox"/>	BAM4	1SNK900001R0000	50	14.00
		BAZ1	1SNK900002R0000	50	5.30
2 End sections	Grey <input type="checkbox"/>	FED10S1	1SNA215999R2100	20	3.35
3 Test plugs	Red <input type="checkbox"/>	FC4-1	1SNA167927R1000	10	11.00
4 Terminal block markers	White <input type="checkbox"/>	RC1010	1SNA238000R1600	1	1.30

Complete list of accessories is indicated in the terminal block datasheet.
Some accessories such as jumper bars may modify the terminal block's ratings: complete information in the accessories catalogue pages.

Technical data valid for copper conductors only.

D6/10.SNBTB screw clamp terminal blocks

Test disconnect with blade - 10 mm 0.394 in spacing

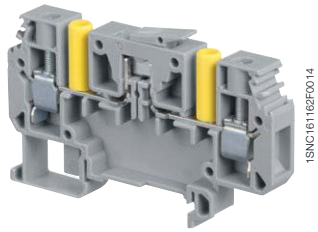
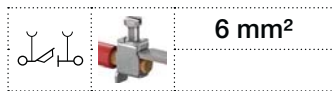

D6/10.SNBTB

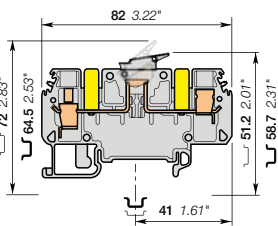

Description

- Ease your disconnect operations with the disconnect blade,
- Ease your test operations with built-in test sockets compatible with DIA 4 mm 0.157 in test plugs.

Ordering details

Description	Color	Type	Part Number	Pkg pce	Weight (1 pce) g
Disconnect With 2 isolated test sockets DIA 4 mm 0.157 in	Grey <input type="checkbox"/>	D6/10.SNBTB2	1SNA115929R1600	20	25.00

Main technical data

		IEC	UL	CSA
1 conductor per clamp	Rigid: Solid/Stranded	0.5-10 mm ²		
	Flexible without ferrule	0.5-6 mm ²		
	Flexible with insulated ferrule			
	Gauge	A5		
Rated current / Rated cross section		15 A / 6 mm ²		
Rated short-time withstand current (1s)		720 A		
Rated voltage		500 V		
Impulse withstand voltage		6000 V		
Protection		IP20	NEMA 1	

Mounting instructions

Rail		G32, TH 35-7.5, TH 35-15
Wire stripping length		12 mm 0.47 in
Tool		Flat screwdriver Ø 4 mm Ø 0.157 in
Torque		0.8 N.m 7.1 lb.in

The connecting capacity data for one Rigid: Solid/Stranded, or one Flexible conductor (when applicable) is a mandatory information required by IEC, UL and CSA standards (Copper conductors). All other data are provided as supplementary information only. For more details, please consult our CB, UL or CSA certificates and technical datasheet available on <http://www.TE.com>

CE	RoHS								
CE	RoHS	Gost R							

10 mm 0.394 in spacing

7

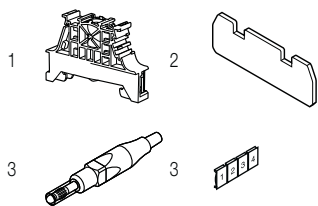

Accessories

Description	Color	Type	Part Number	Pkg pce	Weight (1 pce) g
1 End stops	Dark grey <input type="checkbox"/>	BAM4	1SNK900001R0000	50	14.00
		BAZ1	1SNK900002R0000	50	5.30
2 End sections	Grey <input type="checkbox"/>	FED10S1	1SNA215999R2100	20	3.35
3 Test plugs	Red <input type="checkbox"/>	FC4-1	1SNA167927R1000	10	11.00
4 Terminal block markers	White <input type="checkbox"/>	RC1010	1SNA238000R1600	1	1.30

Complete list of accessories is indicated in the terminal block datasheet.
Some accessories such as jumper bars may modify the terminal block's ratings: complete information in the accessories catalogue pages.

Technical data valid for copper conductors only.

M4/6.ST screw clamp terminal blocks

Test disconnect with plug - 6 mm 0.236 in spacing

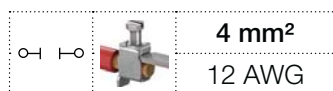

4 mm²
12 AWG

Description

- Test disconnect terminal blocks operated with plug,
- Dedicated "make before break" plug for current circuit (green plug) or "break before make" for voltage circuit (red plug).

Ordering details

Description	Color	Type	Part Number	Pkg pce	Weight (1 pce) g
Disconnect	Tinned contact blades	Grey <input type="checkbox"/> M4/6.ST.Sn	1SNA115313R1400	20	14.00
	Gold contact blades	M4/6.ST.Au	1SNA115314R1500	20	14.00

Main technical data

		IEC	UL	CSA	Mounting instructions	
1 conductor per clamp	Rigid: Solid/Stranded	0.5 - 4 mm ²		22-12 AWG	Rail	G32, TH 35-7.5, TH 35-15
	Flexible without ferrule	0.5 - 4 mm ²			Wire stripping length	9.5 mm 0.374 in
	Flexible with insulated ferrule				Tool	Flat screwdriver Ø 4 mm Ø 0.157 in
	Gauge	A4				
Rated current / Rated cross section		5 A / 4 mm ²		5 A / 12 AWG	Torque	0.5 - 0.8 Nm 4.4 - 7.1 lb.in
Rated short-time withstand current (1s)		480 A				
Rated voltage		500 V		150 V		
Impulse withstand voltage						
Protection		IP10	NEMA			

The connecting capacity data for one Rigid: Solid/Stranded, or one Flexible conductor (when applicable) is a mandatory information required by IEC, UL and CSA standards (Copper conductors). All other data are provided as supplementary information only. For more details, please consult our CB, UL or CSA certificates and technical datasheet available on <http://www.TE.com>

--	--	--	--

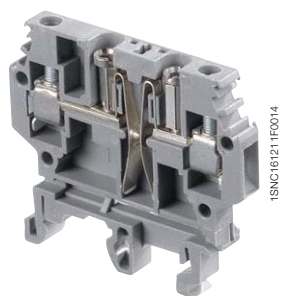

M4/6.ST

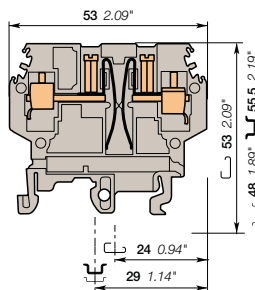

6 mm 0.236 in spacing

Utilization of each type of plug

Number of operations : 200

On request, the plugs can be replaced by an insertable printed circuit for diagnosis testing.

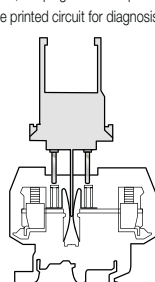

BNT1 ("voltage" plug)

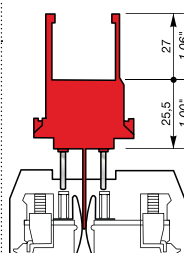

1st step: the plug cuts the circuit.
2nd step: the test circuit connection is made.

BNT2 ("polarity" plug)

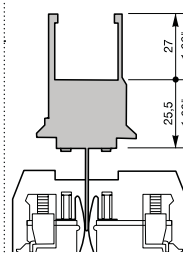

Plug not equipped with pins cuts the circuit.

BNT3 ("current" plug)

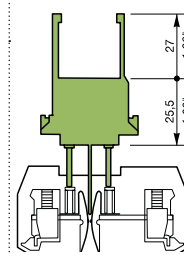

1st step : the test circuit is established
2nd step : the plug opens the circuit.

Accessories

Description	Color	Type	Part Number	Pkg pce	Weight (1 pce) g
1 End stops	Dark grey <input type="checkbox"/>	BAM4	1SNK900001R0000	50	14.00
		BAZ1	1SNK900002R0000	50	5.30
2 End sections	Grey <input type="checkbox"/>	FEMT3	1SNA114328R2200	20	2.70
3 Jumper bars	Grey <input type="checkbox"/>	AD2.5	1SNA114205R2000	50	1.60
4 Lateral jumper bars		PC61-10	1SNA163311R2200	10	5.00
5 Shield connectors		CBM5	1SNA178745R1400	50	
6 Short circuit plugs	Grey <input type="checkbox"/>	BNT2	1SNA114329R2300	20	3.00
	Red <input type="checkbox"/>	BNT1	1SNA199135R1700	20	8.00
	Green <input type="checkbox"/>	BNT3	1SNA199136R1000	20	8.00
7 Assembly pins for plugs		CVABM	1SNA183436R0500	10	0.40
8 Pins		BRC-0.5	1SNA174558R0500	10	1.40
		BRC-1	1SNA173906R2200	10	2.00
		BRC-1.5	1SNA173907R2300	10	2.00
		BRC-2.5	1SNA173908R0400	10	2.00
		BRC-4	1SNA174601R0100	10	2.00
9 Tools		PSC	1SNA173181R1300	1	
10 Terminal block markers	White <input type="checkbox"/>	RC610	1SNA233000R0100	1	7.50

Complete list of accessories is indicated in the terminal block datasheet.

Some accessories such as jumper bars may modify the terminal block's ratings: complete information in the accessories catalogue pages.

Technical data valid for copper conductors only.

M10/10.ST-Sn screw clamp terminal blocks

Test disconnect with plug - 10 mm 0.394 in spacing

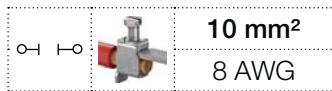

M10/10.ST-Sn

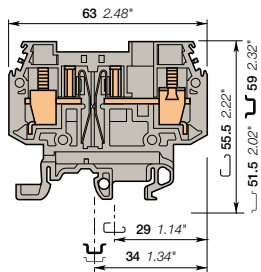

10 mm 0.394 in spacing

Description

- Test disconnect terminal blocks operated with plug,
- Dedicated "make before break" plug for current circuit (green plug) or "break before make" for voltage circuit (red plug).

Ordering details

Description	Color	Type	Part Number	Pkg pce	Weight (1 pce) g
Disconnect Tinned contact blades	Grey	M10/10.ST-Sn	1SNA115539R1700	20	27.00

Main technical data

		IEC	UL	CSA	Mounting instructions	
1 conductor per clamp	Rigid: Solid/Stranded	0.5-16 mm ²		8 AWG	Rail	G32, TH 35-7.5, TH 35-15
	Flexible without ferrule	0.5-10 mm ²			Wire stripping length	12 mm 0.472 in
	Flexible with insulated ferrule				Tool	Flat screwdriver Ø 5.5 - 6 mm Ø 0.217 - 0.236 in
	Gauge	B6			Torque	1.2 - 1.4 Nm 10.6 - 12.3 lb.in
Rated current / Rated cross section		15 A / 10 mm ²		10 A / 8 AWG		
Rated short-time withstand current (1s)		1200 A				
Rated voltage		500 V		300 V		
Impulse withstand voltage						
Protection		IP20		NEMA 1		

The connecting capacity data for one Rigid: Solid/Stranded, or one Flexible conductor (when applicable) is a mandatory information required by IEC, UL and CSA standards (Copper conductors). All other data are provided as supplementary information only. For more details, please consult our CB, UL or CSA certificates and technical datasheet available on <http://www.TE.com>

CE	RoHS	CSA	Gost R
----	------	-----	--------

Utilization of each type of plug

Number of operations : 200

On request, the plugs can be replaced by an insertable printed circuit for diagnosis testing.

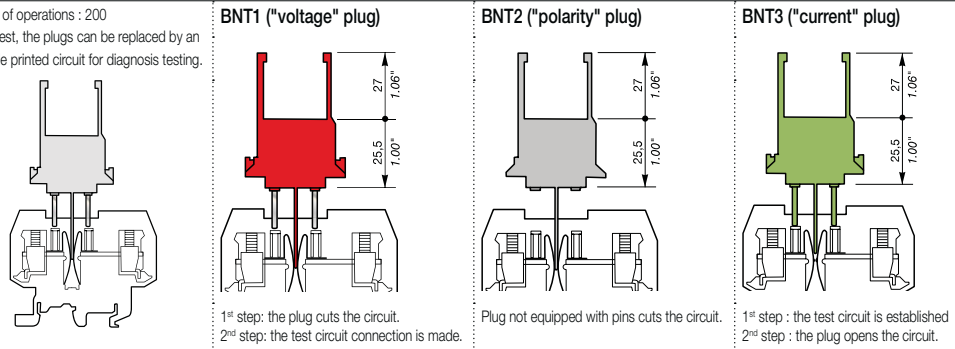

Accessories

Description	Color	Type	Part Number	Pkg pce	Weight (1 pce) g	
1 End stops	Dark grey	BAM4	1SNK900001R0000	50	14.00	
		BAZ1	1SNK900002R0000	50	5.30	
2 End sections	Grey	FEMT5	1SNA116781R1300	20	3.00	
3 Jumper bars		2 poles	BJMI10-2	1SNA176675R0400	10	5.00
		3 poles	BJMI10-3	1SNA176676R0500	10	8.00
4 Lateral jumper bars	4 poles	BJMI10-4	1SNA176677R0600	10	11.00	
	5 poles	BJMI10-5	1SNA176678R1700	10	13.00	
	10 poles	BJMI10-10	1SNA176679R1000	10	27.00	
	5 Shield connectors	PC10-10	1SNA163315R2600	10	23.00	
	6 Short circuit plugs	CBM5	1SNA178745R1400	50		
7 Assembly pins for plugs	Grey	BNT2	1SNA114329R2300	20	3.00	
	Red	BNT1	1SNA199135R1700	20	8.00	
	Green	BNT3	1SNA199136R1000	20	8.00	
8 Pins	White	CVABM1	1SNA116783R1500	20		
		0.5 mm ² 24-20 AWG	BRC-0.5	1SNA174558R0500	10	1.40
		1 mm ² 18 AWG	BRC-1	1SNA173906R2200	10	2.00
		1.5 mm ² 16 AWG	BRC-1.5	1SNA173907R2300	10	2.00
		2.5 mm ² 14 AWG	BRC-2.5	1SNA173908R0400	10	2.00
9 Tools	White	4 mm ² 12 AWG	BRC-4	1SNA174601R0100	10	2.00
		Connecting capacity: 1 to 2.5 mm ²	PSC	1SNA173181R1300	1	
10 Terminal block markers	Blank card	RC1010	1SNA238000R1600	1	1.30	

Complete list of accessories is indicated in the terminal block datasheet.

Some accessories such as jumper bars may modify the terminal block's ratings: complete information in the accessories catalogue pages.

Technical data valid for copper conductors only.

M6/8.STP screw clamp terminal blocks

Disconnect with push-turn knob - with test socket - 8 mm 0.315 in spacing



6 mm²
8 AWG



M6/8.STP

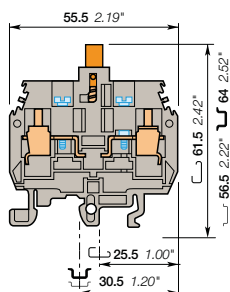

8 mm 0.315 in spacing

Description

- Ease your disconnect operations with the disconnect 1/4 turn push-turn knob,
- Possibility to seal in the open and closed position,
- Ease your test operations with the built-in test socket.

Ordering details

Description	Color	Type	Part Number	Pkg qty	Weight (1 pce)
Disconnect With 2 test sockets DIA 4 mm 0.157 in	Grey, orange	M6/8.STP1	1SNA115529R1500	25	21.00

Main technical data

Connecting capacity		IEC	UL	CSA	Mounting instructions	
1 conductor per clamp	Rigid: Solid/Stranded	0.5-10 mm ²		8 AWG	Rail	G32, TH 35-7.5, TH 35-15
	Flexible without ferrule	0.5-6 mm ²			Wire stripping length	11 mm 0.433 in
	Flexible with insulated ferrule				Tool	Flat screwdriver Ø 4 mm Ø 0.157 in
Gauge					Torque	0.8 - 1 N.m 7.1 - 8.9 lb.in
Rated current / Rated cross section		15 A / 6 mm ²		15 A / 8 AWG		
Rated short-time withstand current (1s)		720 A				
Rated voltage		500 V		600 V		
Impulse withstand voltage						
Protection		IP10		NEMA		

The connecting capacity data for one Rigid: Solid/Stranded, or one Flexible conductor (when applicable) is a mandatory information required by IEC, UL and CSA standards (Copper conductors). All other data are provided as supplementary information only. For more details, please consult our CB, UL or CSA certificates and technical datasheet available on <http://www.TE.com>

RoHS	CSA	Gost R
------	-----	--------

Notes

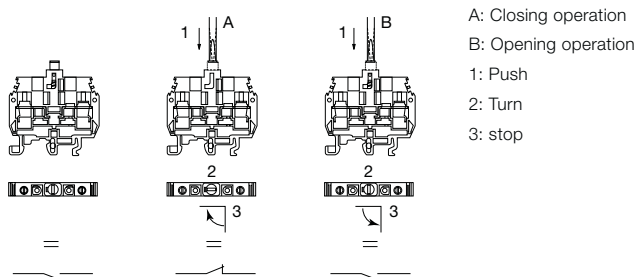

Accessories

Description	Color	Type	Part Number	Pkg qty	Weight (1 pce)
1 End stops	Dark grey	BAM4	1SNK900001R0000	50	14.00
		BAZ1	1SNK900002R0000	50	4.70
2 End sections	Grey	FEMT1	1SNA113137R0200	50	2.00
3 Lateral jumper bars		PC8-2	1SNA116538R1700	10	3.00
		PC8-3	1SNA116539R1000	10	4.00
		PC8-4	1SNA116540R2500	10	6.00
		PC8-10	1SNA163313R2400	10	14.00
4 Circuit separators	Grey	SCFT1	1SNA103588R2600	20	20.00
5 Test plugs	White	FC4	1SNA167860R0100	10	10.00
	Red	FC4-1	1SNA167927R1000	10	11.00
6 Short circuit plugs		BP8.A4	1SNA173888R2000	10	
	Red	BNSTP2	1SNA196789R2400	20	10.00
	Beige	BNSTP1	1SNA196792R1700	20	14.00
7 Terminal block markers	White	RC810	1SNA234000R0200	1	8.20

Complete list of accessories is indicated in the terminal block datasheet.

Some accessories such as jumper bars may modify the terminal block's ratings: complete information in the accessories catalogue pages.

Feed-through screw clamp terminal blocks

Description	Color	Type	Part Number	Pkg qty	Weight (1 pce)
Feed-through Profile aligned with M6/8 STP...	Grey	M6/8.STP3	1SNA115500R2500	25	21.00

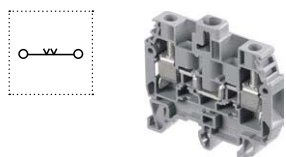

Technical data valid for copper conductors only.

M6/8.STP screw clamp terminal blocks

Disconnect with push-turn knob - with test socket - 8 mm 0.315 in spacing

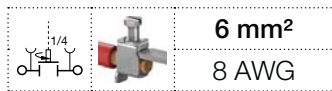

M6/8.STP

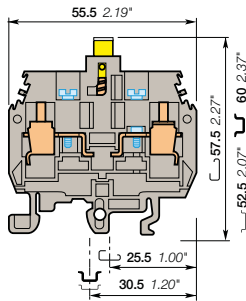

8 mm 0.315 in spacing

Description

- Ease your disconnect operations with the disconnect 1/4 turn push-turn knob,
- Possibility to seal in the open position,
- Ease your test operations with the built-in test socket.

Ordering details

Description	Color	Type	Part Number	Pkg qty	Weight (1 pce) g
Disconnect With 2 test sockets DIA 4 mm 0.157 in	Grey, yellow	M6/8.STP	1SNA115277R2000	25	21.00
	Grey, black	M6/8.STP	1SNA105141R2700	25	21.00
	Grey, red	M6/8.STP	1SNA105142R2000	25	21.00

Main technical data

Connecting capacity	IEC	UL	CSA	Mounting instructions	
1 conductor per clamp Rigid: Solid/Stranded Flexible without ferrule Flexible with insulated ferrule Gauge	0.5-10 mm²	22-8 AWG	8 AWG	Rail	G32, TH 35-7.5, TH 35-15
	Wire stripping length			Wire stripping length	11 mm 0.433 in
	Tool			Tool	Flat screwdriver Ø 4 mm Ø 0.157 in
	Rated current / Rated cross section	15 A / 6 mm²	40 A / 8 AWG	15 A / 8 AWG	Torque
Rated short-time withstand current (1s)	180 A				
Rated voltage	500 V	600 V	600 V		
Impulse withstand voltage					
Protection	IP10	NEMA			

The connecting capacity data for one Rigid: Solid/Stranded, or one Flexible conductor (when applicable) is a mandatory information required by IEC, UL and CSA standards (Copper conductors). All other data are provided as supplementary information only. For more details, please consult our CB, UL or CSA certificates and technical datasheet available on <http://www.TE.com>

RoHS	UL	CSA	Gost R
RoHS	USR	CSA	Gost R

Notes

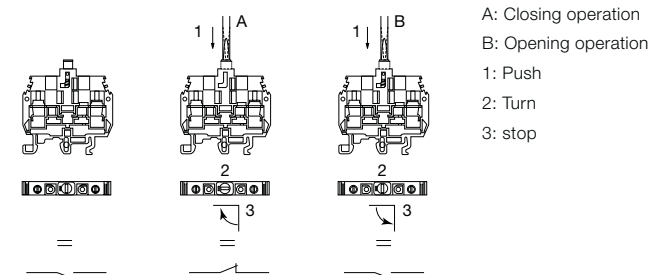

Accessories

Description	Color	Type	Part Number	Pkg qty	Weight (1 pce) g		
1 End stops	Dark grey	BAM4	1SNK900001R0000	50	14.00		
		BAZ1	1SNK900002R0000	50	4.70		
2 End sections	Grey	FEMT1	1SNA113137R0200	50	2.00		
3 Lateral jumper bars		2 poles	PC8-2	1SNA116538R1700	10	3.00	
		3 poles	PC8-3	1SNA116539R1000	10	4.00	
		4 poles	PC8-4	1SNA116540R2500	10	6.00	
		10 poles	PC8-10	1SNA163313R2400	10	14.00	
4 Circuit separators	Grey	SCFT1	1SNA103588R2600	20	20.00		
5 Test plugs	White	FC4	1SNA167860R0100	10	10.00		
	Red	FC4-1	1SNA167927R1000	10	11.00		
6 Short circuit plugs		DIA 4 mm 0.157 in	BP8-A4	1SNA173888R2000	10		
		With test DIA 4 mm 0.157 in	Red	BNSTP2	1SNA196789R2400	20	10.00
			Beige	BNSTP1	1SNA196792R1700	20	14.00
7 Terminal block markers	White	RC810	1SNA234000R0200	1	8.20		

Complete list of accessories is indicated in the terminal block datasheet.

Some accessories such as jumper bars may modify the terminal block's ratings: complete information in the accessories catalogue pages.

Feed-through screw clamp terminal blocks

Description	Color	Type	Part Number	Pkg qty	Weight (1 pce) g
Feed-through Profile aligned with M6/8 STP...	Grey	M6/8.STP3	1SNA115500R2500	25	21.00

Technical data valid for copper conductors only.

D6/8.ST.RS spring loaded screw clamp terminal blocks

Test disconnect with a screwdriver sliding link - 8 mm 0.315 in spacing



6 mm²



D6/8.ST.RS

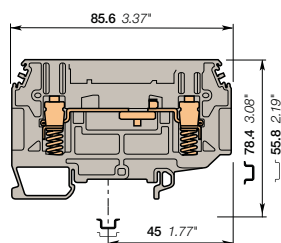

8 mm 0.315 in spacing

Description

- Mainly dedicated to energy markets for security purposes on CT circuits,
- Security: specific shape in linking bar to lock the ferrule, spring clamp can maintain contact pressure even if screw clamp is loose.

Ordering details

Description	Color	Type	Part Number	Pkg pce	Weight (1 pce) g
Disconnect	Grey <input type="checkbox"/>	D6/8.ST.RS	1SNA115914R0700	32	28.00

Main technical data

		IEC	BS TS 5018	CSA	Mounting instructions
1 conductor per clamp	Rigid: Solid/Stranded	0.5-10 mm ²			Rail G32, TH 35-7.5, TH 35-15
	Flexible without ferrule	0.5-6 mm ²			Wire stripping length 16 mm 0.51 in
	Flexible with insulated ferrule				
Lugs	Flexible with insulated ferrule		0.28-2.5 mm ²		Tool Flat screwdriver Ø 3.5 mm Ø 0.138 in
	Gauge	A5			
Rated current / Rated cross section		24 A / 6 mm ²			Torque 0.8 - 1 Nm 7.1 - 8.9 lb.in
Rated short-time withstand current (1s)		720 A			
Rated voltage		400 V			
Impulse withstand voltage		6000 V			
Protection		NEMA			

The connecting capacity data for one Rigid: Solid/Stranded, or one Flexible conductor (when applicable) is a mandatory information required by IEC, UL and CSA standards (Copper conductors). All other data are provided as supplementary information only. For more details, please consult our CB, UL or CSA certificates and technical datasheet available on <http://www.TE.com>

--	--	--	--	--	--

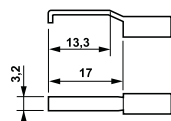

Each screw clamp holds up to 2 bent lugs as shown (not supplied)

Accessories

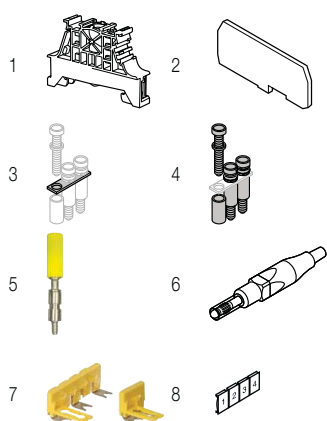

Description	Color	Type	Part Number	Pkg pce	Weight (1 pce) g
1 End stops	Dark grey <input type="checkbox"/>	BAM4	1SNK900001R0000	50	14.00
		BAZ1	1SNK900002R0000	50	5.30
2 End sections	Grey <input type="checkbox"/>	FEM8T6	1SNA215266R0100	10	4.40
3 Jumper bars		BJS8	1SNA164581R1300	10	3.10
			1SNA164582R1400	10	3.10
			1SNA164583R1500	10	3.10
		BJS8-20	1SNA174789R0500	5	3.20
4 Fastening kits		EV61	1SNA206394R0200	20	2.00
5 Test sockets	Yellow <input type="checkbox"/>	AJS9	1SNA179726R0200	25	3.60
	Black <input type="checkbox"/>	AJS9-1	1SNA206680R1500	25	3.60
	Green <input type="checkbox"/>	AJS9-2	1SNA206681R0200	25	3.60
	Grey <input type="checkbox"/>	AJS9-3	1SNA206682R0300	25	3.60
	Blue <input type="checkbox"/>	AJS9-4	1SNA206683R0400	25	3.60
	Red <input type="checkbox"/>	AJS9-5	1SNA206720R1400	25	3.60
6 Test plugs		AL4-M3	1SNA206721R0100	50	1.10
	Red <input type="checkbox"/>	FC4-1	1SNA167927R1000	10	11.00
	Yellow <input type="checkbox"/>	SC-JB8-2	1SNK900652R0000	25	2.00
		SC-JB8-3	1SNK900653R0000	25	3.40
7 Short circuit bridges		SC-JB8-4	1SNK900654R0000	25	4.70
	White <input type="checkbox"/>	RC810	1SNA234000R0200	1	8.20

Complete list of accessories is indicated in the terminal block datasheet. Some accessories such as jumper bars may modify the terminal block's ratings: complete information in the accessories catalogue pages.

Technical data valid for copper conductors only.

D6/8.ST.RS spring loaded screw clamp terminal blocks

Test disconnect with a screwdriver sliding link - 8 mm 0.315 in spacing



6 mm²



1SN1C161233F0014

D6/8.ST.RS

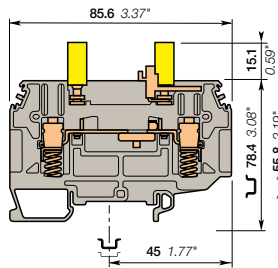

8 mm 0.315 in spacing

Description

- Mainly dedicated to energy markets for security purposes on CT circuits,
- Security: specific shape in linking bar to lock the ferrule, spring clamp can maintain contact pressure even if screw clamp is loose.

Ordering details

Description	Color	Type	Part Number	Pkg pce	Weight (1 pce) g
Disconnect With 2 yellow test sockets DIA 4 mm 0.157 in	Grey <input type="checkbox"/>	D6/8.ST1.RS.IP20	1SNA115831R0400	32	38.00

Main technical data

		IEC	BS	CSA	Mounting instructions	
			TS 5018		Rail	G32, TH 35-7.5, TH 35-15
1 conductor per clamp	Rigid: Solid/Stranded	0.5-10 mm ²			Wire stripping length	16 mm 0.51 in
	Flexible without ferrule	0.5-6 mm ²				
	Flexible with insulated ferrule					
Lugs	Flexible with insulated ferrule		0.28-2.5 mm ²		Screw clamp Tool	Flat screwdriver Ø 3.5 mm Ø 0.138 in
	Gauge	A5			Torque	0.8 - 1 Nm 7.1 - 8.9 lb.in
Rated current / Rated cross section		24 A / 6 mm ²			Disconnect device Tool	Flat screwdriver Ø 3.5 mm Ø 0.138 in
Rated short-time withstand current (1s)		720 A			Torque	0.4 - 0.6 N.m 3.5 - 5.3 lb.in
Rated voltage		400 V			Test socket Tool	Ø 3.5 mm Ø 0.138 in
Impulse withstand voltage		6000 V			Torque	0.6 N.m 5.34 lb.in
Protection				NEMA		

The connecting capacity data for one Rigid: Solid/Stranded, or one Flexible conductor (when applicable) is a mandatory information required by IEC, UL and CSA standards (Copper conductors). All other data are provided as supplementary information only. For more details, please consult our CB, UL or CSA certificates and technical datasheet available on <http://www.TE.com>

CE	RoHS	Gost R							
----	------	--------	--	--	--	--	--	--	--

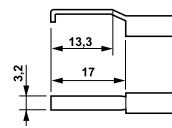

Each screw clamp holds up to 2 bent lugs as shown (not supplied)

Accessories

Description	Color	Type	Part Number	Pkg pce	Weight (1 pce) g
1 End stops	Dark grey <input type="checkbox"/>	BAM4	1SNK900001R0000	50	14.00
		BAZ1	1SNK900002R0000	50	5.30
2 End sections	Grey <input type="checkbox"/>	FEM8T6	1SNA215266R0100	10	4.40
3 Jumper bars	Grey <input type="checkbox"/>	AD2.5	1SNA114205R2000	50	1.60
4 Test sockets	Black <input type="checkbox"/>	AJS9-1	1SNA206680R1500	25	3.60
	Green <input type="checkbox"/>	AJS9-2	1SNA206681R0200	25	3.60
	Grey <input type="checkbox"/>	AJS9-3	1SNA206682R0300	25	3.60
	Blue <input type="checkbox"/>	AJS9-4	1SNA206683R0400	25	3.60
	Red <input type="checkbox"/>	AJS9-5	1SNA206720R1400	25	3.60
5 Test plugs	Red <input type="checkbox"/>	FC4-1	1SNA167927R1000	10	11.00
6 Short circuit bridges	Yellow <input type="checkbox"/>	SC-JB8-2	1SNK900652R0000	25	2.00
		SC-JB8-3	1SNK900653R0000	25	3.40
		SC-JB8-4	1SNK900654R0000	25	4.70
			SC-JB8-4	1SNK900654R0000	25
7 Terminal block markers	White <input type="checkbox"/>	RC810	1SNA234000R0200	1	8.20

Complete list of accessories is indicated in the terminal block datasheet.

Some accessories such as jumper bars may modify the terminal block's ratings: complete information in the accessories catalogue pages.

Technical data valid for copper conductors only.



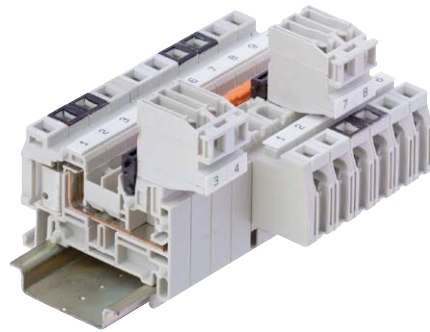
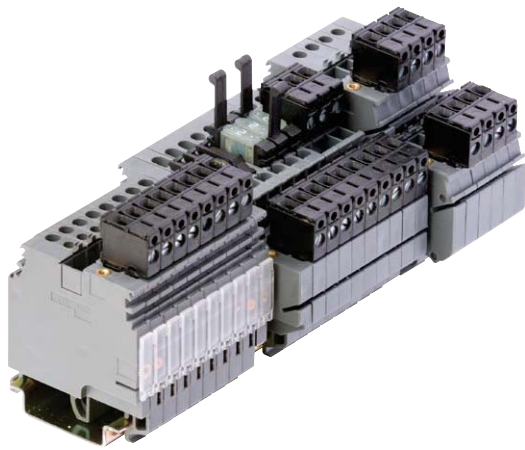

1SNC164011S0201

Dedicated applications terminal blocks

Pluggable

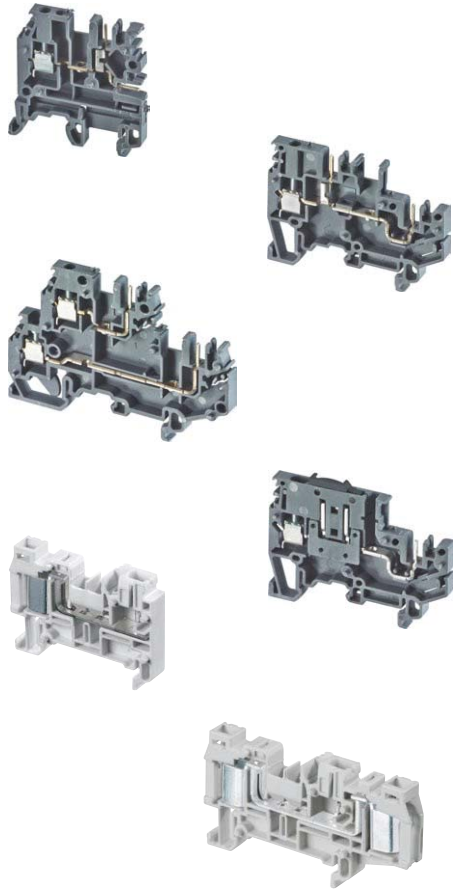

Technologies presentation	174
Overview	175

Screw clamp technology

Feed-through

2.5 mm ² / 12 AWG	MA2.5/5-CPE	176
	MA2.5/5-2CPE	178

Double deck

2.5 mm ² / 12 AWG	MA2.5/5D2-2CPE	2 feed-through circuits	180
	MA2.5/5.D-2CPE	1 feed-through circuit	181

Disconnect with blade

2.5 mm ² / 12 AWG	MA2.5/5-SNB-CPE	182
------------------------------	------------------------	-----

ADO technology

Feed-through

1.5 mm ² / 16 AWG	D1.5/7.ADO-CPE	1 ADO - 1 pluggable	183
	D1.5/7.2ADO-CPE	2 ADO - 1 pluggable	185
2.5 mm ² / 14 AWG	D2.5/7.ADO-CPE	1 ADO - 1 pluggable	184
	D2.5/7.2ADO-CPE	2 ADO - 1 pluggable	186

Dedicated applications terminal blocks

Pluggable



Optimize your equipment assembly process!

TE connectivity's pluggable terminal blocks offer the possibility to use pre-assembled cables and connectors which improve wiring efficiency.

Pluggable technology offers following advantages:

- Wiring can be pre-defined and pre-tested before final assembling
- During assembling, the pre-assembled cables help in saving time (plug & play solution) and reduce wiring errors
- During servicing, rail assemblies or components can be quickly replaced.

The preferred solution for OEM's and panel builders handling cabinets made of multiple separate modules.



RoHS

ISO 9001
ISO 14001



A large choice of solutions and technologies

Screw clamp pluggable technology

TE connectivity's screw clamp pluggable range combines the advantage of a fast connection associated with the standard easy to use screw technology.

The range features various functions such as : feed-through, neutral, double deck, disconnect and fuse.

PI-Spring screwless pluggable technology

Our PI-Spring pluggable range combines fast assembly and fast wiring thanks to our exclusive tool-free direct insertion connection technology.

The range features functions adapted to OEM's applications such as 2 jumper channels for distribution, testing, high density wiring with dual connection on both side.

Find more in our SNK series catalog.

ADO System® screwless pluggable technology

Combines fast assembly with the Fastest and the Most Reliable Connection on the Market.

Our ADO System® range features high ratings 4 mm²/24 A max and high density wiring with dual connection and up to 2 wires per ADO System® connection.



Screw clamp pluggable terminal block



ADO System® pluggable terminal block

15NC164010S0201

Dedicated applications terminal blocks



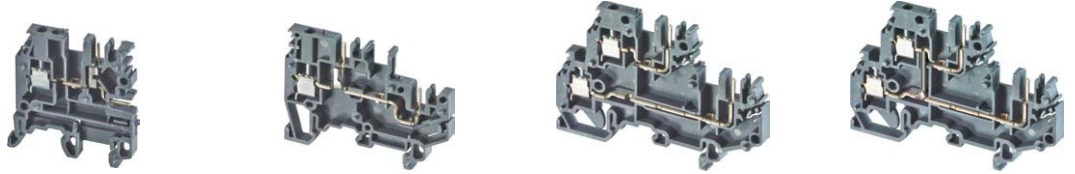

Pluggable

Screw clamp technology



Feed-through

Double deck

Section					
IEC	UL/CSA				
2.5 mm ²	12 AWG	MA2.5/5-CPE 5 mm 0.197 in	MA2.5/5-2CPE 5 mm 0.197 in	MA2.5/5D2-2CPE 5 mm 0.197 in	MA2.5/5.D-2CPE 5 mm 0.197 in

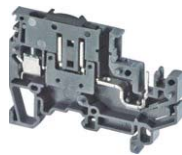



Disconnect with blade

Section		
IEC	UL/CSA	
2.5 mm ²	12 AWG	MA2.5/5-SNB-CPE 5 mm 0.197 in

ADO technology



Feed-through

Section			
IEC	UL/CSA		
1.5 mm ²	16 AWG	D1.5/7.ADO-CPE 7.62 mm 0.300 in	D1.5/7.2ADO-CPE 7.62 mm 0.300 in
2.5 mm ²	14 AWG	D2.5/7.ADO-CPE 7.62 mm 0.300 in	D2.5/7.2ADO-CPE 7.62 mm 0.300 in

MA2.5/5-CPE pluggable terminal blocks

Feed-through - 5.08 mm 0.200 in spacing

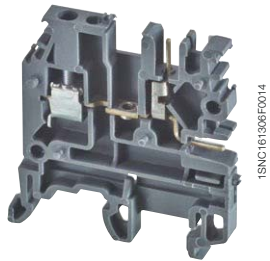

MA2.5/5-CPE

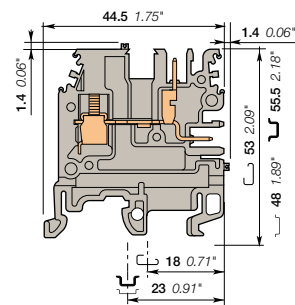

5.08 mm 0.200 in spacing

Description

- Save in flexibility, reliability and simplicity thanks to the pluggable terminal blocks,
- They are particularly well adapted to solve the connecting problems of equipment composed of sub-assemblies (complex machines such as elevators or trains, panel boards with extension boxes...),
- They can then be easily connected through patchcords with CPFT2 plugs connected to the pluggable terminal blocks outputs.

Ordering details

Description	Color	Type	Part Number	Pkg pce	Weight (1 pce) g
Feed-through 1 feed-through circuit	Grey <input type="checkbox"/>	MA2.5/5-CPE	1SNA400814R0000	50	7.00
	Blue <input type="checkbox"/>	MA2.5/5-CPE	1SNA400827R0000	50	7.00

Main technical data

	IEC	UL	CSA
1 conductor per clamp	Rigid: Solid/Stranded	0.2-4 mm ²	24-12 AWG
	Flexible without ferrule	0.22-2.5 mm ²	
	Flexible with insulated ferrule		
	Gauge	A3	
Rated current / Rated cross section		12 A / 2.5 mm ²	10 A / 12 AWG
Rated short-time withstand current (1s)		300 A	
Rated voltage		320 V	300 V
Impulse withstand voltage		4000 V	
Protection		IP20	NEMA 1

Mounting instructions

Rail		G32, TH 35-7.5, TH 35-15
Wire stripping length		8.5 mm 0.33 in
Tool		Flat screwdriver Ø 3.5 mm Ø 0.138 in
Torque		0.4 - 0.6 Nm 3.5 - 5.3 lb.in

The connecting capacity data for one Rigid: Solid/Stranded, or one Flexible conductor (when applicable) is a mandatory information required by IEC, UL and CSA standards (Copper conductors). All other data are provided as supplementary information only. For more details, please consult our CB, UL or CSA certificates and technical datasheet available on <http://www.TE.com>

CE	RoHS	cULus	UL	CSAus	Gost R
CE	RoHS	USR CNR		cCSAus	Gost R

Accessories

Description	Color	Type	Part Number	Pkg pce	Weight (1 pce) g	
1 End stops	Dark grey <input type="checkbox"/>	BAM4	1SNK900001R0000	50	14.00	
		BAZ1	1SNK900002R0000	50	5.30	
2 End sections	Grey <input type="checkbox"/>	FEM6	1SNA400824R0000	20	2.40	
3 End section-flange kit (R+L)	Grey <input type="checkbox"/>	ENS.FE-BCP	1SNA400819R0000	10	7.00	
4 Jumper bars	Grey <input type="checkbox"/>	2 poles 24 A	BJMI5-2	1SNA176278R1600	10	3.30
		3 poles	BJMI5-3	1SNA176279R1700	10	5.00
		4 poles	BJMI5-4	1SNA176280R0500	10	6.70
		10 poles	BJMI5-10	1SNA176282R2300	10	16.90
5 Lateral jumper bars	Grey <input type="checkbox"/>	2 poles 30 A	PC5-2	1SNA113542R1000	10	1.80
		10 poles	PC5-10	1SNA113544R1200	10	6.00
6 Cross spacing jumpers		EL6	1SNA173627R2100	10	0.10	
7 Shield connectors		CBM5	1SNA178745R1400	50	5.70	
8 Coding pegs		COCF 32	1SNA173660R1600	10	0.10	
		COC 1	1SNA299777R1600	10		
9 Female plugs wires parallel	Black <input type="checkbox"/>	2 poles	CPFT2/2	1SNA094302R2100	120	3.20
		3 poles	CPFT2/3	1SNA094303R2200	80	4.80
		4 poles	CPFT2/4	1SNA094304R2300	60	6.40
		10 poles	CPFT2/10	1SNA094310R2400	20	16.00
		2 poles	CPFT2/R-2	1SNA094352R2200	120	3.80
10 Female plugs wires perpendicular	Black <input type="checkbox"/>	3 poles	CPFT2/R-3	1SNA094353R2300	80	5.70
		4 poles	CPFT2/R-4	1SNA094354R2400	60	7.60
		10 poles	CPFT2/R-10	1SNA094360R0600	20	19.00
		Blank card	RC510	1SNA231000R0700	1	5.20

Complete list of accessories is indicated in the terminal block datasheet.

Some accessories such as jumper bars may modify the terminal block's ratings: complete information in the accessories catalogue pages.

Technical data valid for copper conductors only.

MA2.5/5-CPE pluggable terminal blocks

Feed-through - 5.08 mm 0.200 in spacing

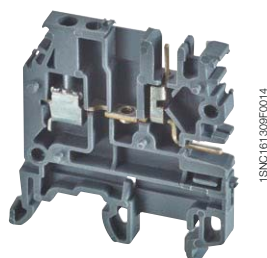

MA2.5/5-CPE

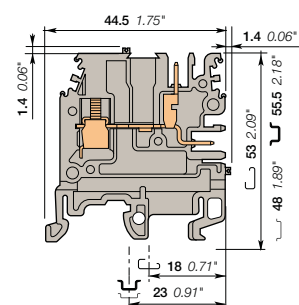

5.08 mm 0.200 in spacing

Description

- Save in flexibility, reliability and simplicity thanks to the pluggable terminal blocks,
- They are particularly well adapted to solve the connecting problems of equipment composed of sub-assemblies (complex machines such as elevators or trains, panel boards with extension boxes...),
- They can then be easily connected through patchcords with CPFT2 plugs connected to the pluggable terminal blocks outputs.

Ordering details

Description	Color	Type	Part Number	Pkg pce	Weight (1 pce) g
Feed-through 1 feed-through circuit with partition	Grey <input type="checkbox"/>	MA2.5/5-CPE.1	1SNA400822R0000	50	7.00

Main technical data

		IEC	UL	CSA	Mounting instructions	
1 conductor per clamp	Rigid: Solid/Stranded	0.2-4 mm ²	24-12 AWG		Rail	G32, TH 35-7.5, TH 35-15
	Flexible without ferrule	0.22-2.5 mm ²			Wire stripping length	8.5 mm 0.33 in
	Flexible with insulated ferrule				Tool	Flat screwdriver Ø 3.5 mm Ø 0.138 in
	Gauge	A3			Torque	0.4 - 0.6 Nm 3.5 - 5.3 lb.in
Rated current / Rated cross section		12 A / 2.5 mm ²	10 A / 12 AWG			
Rated short-time withstand current (1s)		300 A				
Rated voltage		320 V	300 V			
Impulse withstand voltage		4000 V				
Protection		IP20	NEMA 1			

The connecting capacity data for one Rigid: Solid/Stranded, or one Flexible conductor (when applicable) is a mandatory information required by IEC, UL and CSA standards (Copper conductors). All other data are provided as supplementary information only. For more details, please consult our CB, UL or CSA certificates and technical datasheet available on <http://www.TE.com>

CE	RoHS	UL	CSA	Gost R

Accessories

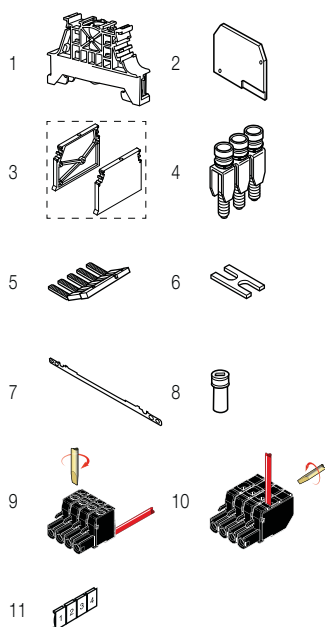

Description	Color	Type	Part Number	Pkg pce	Weight (1 pce) g	
1 End stops	Dark grey <input type="checkbox"/>	BAM4	1SNK900001R0000	50	14.00	
		BAZ1	1SNK900002R0000	50	5.30	
2 End sections	Grey <input type="checkbox"/>	FEM6	1SNA400824R0000	20	2.40	
3 End section-flange kit (R+L)		ENS.FE-BCP	1SNA400819R0000	10	7.00	
4 Jumper bars	Grey <input type="checkbox"/>	2 poles 24 A	BJMI5-2	1SNA176278R1600	10	3.30
		3 poles	BJMI5-3	1SNA176279R1700	10	5.00
		4 poles	BJMI5-4	1SNA176280R0500	10	6.70
		10 poles	BJMI5-10	1SNA176282R2300	10	16.90
5 Lateral jumper bars	Grey <input type="checkbox"/>	2 poles 30 A	PC5-2	1SNA113542R1000	10	1.80
		10 poles	PC5-10	1SNA113544R1200	10	6.00
6 Cross spacing jumpers		EL6	1SNA173627R2100	10	0.10	
7 Shield connectors		CBM5	1SNA178745R1400	50		
8 Coding pegs		COCF 32	1SNA173660R1600	10	0.10	
		COC 1	1SNA299777R1600	10		
		CPFT2/2	1SNA094302R2100	120	3.20	
9 Female plugs wires parallel	Black <input type="checkbox"/>	CPFT2/3	1SNA094303R2200	80	4.80	
		CPFT2/4	1SNA094304R2300	60	6.40	
		CPFT2/10	1SNA094310R2400	20	16.00	
		CPFT2/R-2	1SNA094352R2200	120	3.80	
10 Female plugs wires perpendicular	Black <input type="checkbox"/>	CPFT2/R-3	1SNA094353R2300	80	5.70	
		CPFT2/R-4	1SNA094354R2400	60	7.60	
		CPFT2/R-10	1SNA094360R0600	20	19.00	
		RC510	1SNA231000R0700	1	5.20	
11 Terminal block markers	Blank card	White <input type="checkbox"/>				

Complete list of accessories is indicated in the terminal block datasheet.

Some accessories such as jumper bars may modify the terminal block's ratings: complete information in the accessories catalogue pages.

Technical data valid for copper conductors only.

MA2.5/5-2CPE pluggable terminal blocks

Feed-through - 5.08 mm 0.200 in spacing

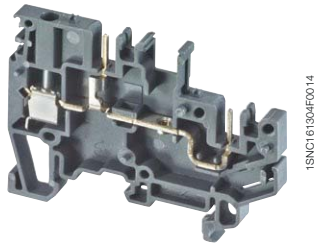

MA2.5/5-2CPE

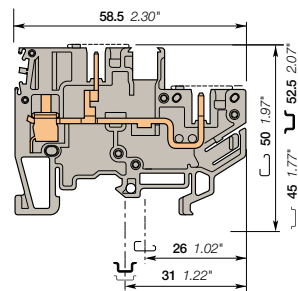

5.08 mm 0.200 in spacing

Description

- Save in flexibility, reliability and simplicity thanks to the pluggable terminal blocks,
- They are particularly well adapted to solve the connecting problems of equipment composed of sub-assemblies (complex machines such as elevators or trains, panel boards with extension boxes...),
- They can then be easily connected through patchcords with CPFT2 plugs connected to the pluggable terminal blocks outputs.

Ordering details

Description	Color	Type	Part Number	Pkg pce	Weight (1 pce) g
Feed-through 1 feed-through circuit	Grey <input type="checkbox"/>	MA2.5/5-2CPE	1SNA400817R0000	50	7.00
	Blue <input type="checkbox"/>	MA2.5/5-2CPE	1SNA125711R1500	50	7.00

Main technical data

	IEC	UL	CSA
1 conductor per clamp	Rigid: Solid/Stranded	0.2-4 mm ²	24-12 AWG
	Flexible without ferrule	0.22-2.5 mm ²	
	Flexible with insulated ferrule		
	Gauge	A3	
Rated current / Rated cross section		12 A / 2.5 mm ²	10 A / 12 AWG
Rated short-time withstand current (1s)		300 A	
Rated voltage		320 V	300 V
Impulse withstand voltage		4000 V	
Protection		IP20	NEMA 1

Mounting instructions

Rail		G32, TH 35-7.5, TH 35-15
Wire stripping length		10 mm 0.394 in
Tool		Flat screwdriver Ø 3.5 mm Ø 0.138 in
Torque		0.4 - 0.6 Nm 3.5 - 5.3 lb.in

The connecting capacity data for one Rigid: Solid/Stranded, or one Flexible conductor (when applicable) is a mandatory information required by IEC, UL and CSA standards (Copper conductors). All other data are provided as supplementary information only. For more details, please consult our CB, UL or CSA certificates and technical datasheet available on <http://www.TE.com>

CE	RoHS	UL	CSA	Gost R
CE	RoHS	UL	CSA	Gost R

Accessories

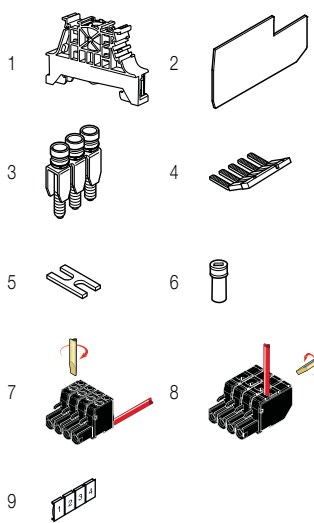

Description	Color	Type	Part Number	Pkg pce	Weight (1 pce) g		
1 End stops	Dark grey <input type="checkbox"/>	BAM4	1SNK900001R0000	50	14.00		
		BAZ1	1SNK900002R0000	50	5.30		
2 End sections	Grey <input type="checkbox"/>	FE2CPE	1SNA400826R0000	20	2.50		
3 Jumper bars		2 poles	24 A	BJMI5-2	1SNA176278R1600	10	3.30
		3 poles		BJMI5-3	1SNA176279R1700	10	5.00
		4 poles		BJMI5-4	1SNA176280R0500	10	6.70
		5 poles		BJMI5-5	1SNA176281R2200	10	8.40
		10 poles		BJMI5-10	1SNA176282R2300	10	16.90
4 Lateral jumper bars	Grey <input type="checkbox"/>	2 poles	30 A	PC5-2	1SNA113542R1000	10	1.80
		10 poles		PC5-10	1SNA113544R1200	10	6.00
5 Cross spacing jumpers		5 mm 0.200 in - 6 mm 0.236 in - 8 mm 0.315 in		EL6	1SNA173627R2100	10	0.10
6 Coding pegs				COCF 32	1SNA173660R1600	10	0.10
				COC 1	1SNA299777R1600	10	
7 Female plugs wires parallel	Black <input type="checkbox"/>	2 poles		CPFT2/2	1SNA094302R2100	120	3.20
		3 poles		CPFT2/3	1SNA094303R2200	80	4.80
		4 poles		CPFT2/4	1SNA094304R2300	60	6.40
		10 poles		CPFT2/10	1SNA094310R2400	20	16.00
8 Female plugs wires perpendicular	Black <input type="checkbox"/>	2 poles		CPFT2/R-2	1SNA094352R2200	120	3.80
		3 poles		CPFT2/R-3	1SNA094353R2300	80	5.70
		4 poles		CPFT2/R-4	1SNA094354R2400	60	7.60
		10 poles		CPFT2/R-10	1SNA094360R0600	20	19.00
9 Terminal block markers	White <input type="checkbox"/>	Blank card		RC510	1SNA231000R0700	1	5.20

Complete list of accessories is indicated in the terminal block datasheet.

Some accessories such as jumper bars may modify the terminal block's ratings: complete information in the accessories catalogue pages.

Technical data valid for copper conductors only.

MA2.5/5-2CPE pluggable terminal blocks

Feed-through - 5.08 mm 0.200 in spacing

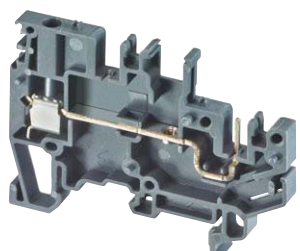

1SNCE161311F0014

MA2.5/5-2CPE

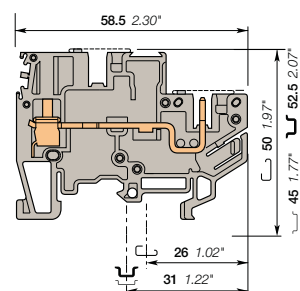

5.08 mm 0.200 in spacing

Description

- Save in flexibility, reliability and simplicity thanks to the pluggable terminal blocks,
- They are particularly well adapted to solve the connecting problems of equipment composed of sub-assemblies (complex machines such as elevators or trains, panel boards with extension boxes...),
- They can then be easily connected through patchcords with CPFT2 plugs connected to the pluggable terminal blocks outputs.

Ordering details

Description	Color	Type	Part Number	Pkg pce	Weight (1 pce) g
Feed-through 1 feed-through circuit for use in combination with disconnect blocks	Grey <input type="checkbox"/>	MA2.5/5-2CPE1-Pb	1SNA400821R0000	50	7.00

Main technical data

	IEC	UL	CSA
1 conductor per clamp			
Rigid: Solid/Stranded	0.2-4 mm ²	24-12 AWG	
Flexible without ferrule	0.22-2.5 mm ²		
Flexible with insulated ferrule			
Gauge	A3		
Rated current / Rated cross section	12 A / 2.5 mm ²	10 A / 12 AWG	
Rated short-time withstand current (1s)	300 A		
Rated voltage	320 V	300 V	
Impulse withstand voltage	4000 V		
Protection	IP20	NEMA 1	

Mounting instructions

Rail		G32, TH 35-7.5, TH 35-15
Wire stripping length		10 mm 0.394 in
Tool		Flat screwdriver Ø 3.5 mm Ø 0.138 in
Torque		0.4 - 0.6 Nm 3.5 - 5.3 lb.in

The connecting capacity data for one Rigid: Solid/Stranded, or one Flexible conductor (when applicable) is a mandatory information required by IEC, UL and CSA standards (Copper conductors). All other data are provided as supplementary information only. For more details, please consult our CB, UL or CSA certificates and technical datasheet available on <http://www.TE.com>

CE	RoHS	UL	Gost R

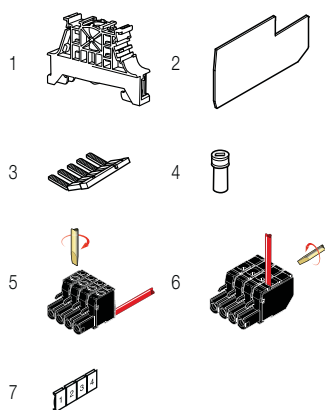

Accessories

Description	Color	Type	Part Number	Pkg pce	Weight (1 pce) g
1 End stops	Dark grey <input type="checkbox"/>	BAM4	1SNK900001R0000	50	14.00
		BAZ1	1SNK900002R0000	50	5.30
2 End sections	Grey <input type="checkbox"/>	FE2CPE	1SNA400826R0000	20	2.50
3 Lateral jumper bars	Grey <input type="checkbox"/>	PC5-2	1SNA113542R1000	10	1.80
		PC5-10	1SNA113544R1200	10	6.00
4 Coding pegs		COCF-32	1SNA173660R1600	10	0.10
		COC 1	1SNA299777R1600	10	
5 Female plugs wires parallel	Black <input type="checkbox"/>	CPFT2/2	1SNA094302R2100	120	3.20
		CPFT2/3	1SNA094303R2200	80	4.80
		CPFT2/4	1SNA094304R2300	60	6.40
		CPFT2/10	1SNA094310R2400	20	16.00
6 Female plugs wires perpendicular	Black <input type="checkbox"/>	CPFT2/R-2	1SNA094352R2200	120	3.80
		CPFT2/R-3	1SNA094353R2300	80	5.70
		CPFT2/R-4	1SNA094354R2400	60	7.60
		CPFT2/R-10	1SNA094360R0600	20	19.00
7 Terminal block markers	White <input type="checkbox"/>	RC510	1SNA231000R0700	1	5.20

Complete list of accessories is indicated in the terminal block datasheet. Some accessories such as jumper bars may modify the terminal block's ratings: complete information in the accessories catalogue pages.

Technical data valid for copper conductors only.

MA2.5/5D-2CPE pluggable terminal blocks

Double deck with 2 feed-through circuits - 5.08 mm 0.200 in spacing

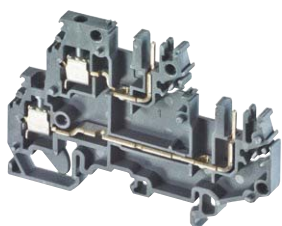

1SNC161302R0014

MA2.5/5D-2CPE

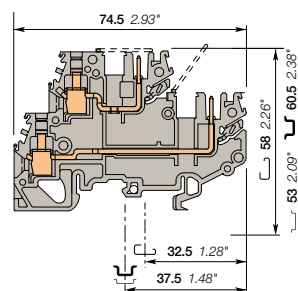

5.08 mm 0.200 in spacing

Description

- Save space with double deck terminal blocks,
- Gain in flexibility, reliability and simplicity thanks to the pluggable terminal blocks,
- Plug & play connection through pre-wired harnesses equipped with CPFT2 plugs.

Ordering details

Description	Color	Type	Part Number	Pkg pce	Weight (1 pce) g
Feed-through 2 feed-through circuits	Grey <input type="checkbox"/>	MA2.5/5.D2-2CPE	1SNA400813R0000	50	12.00
	Blue <input type="checkbox"/>	MA2.5/5.D2-2CPE	1SNA125961R1000	50	12.00

Main technical data

	IEC	UL	CSA	Mounting instructions	
1 conductor per clamp	Rigid: Solid/Stranded	0.2-4 mm ²	24-12 AWG	Rail	G32, TH 35-7.5, TH 35-15
	Flexible without ferrule	0.22-2.5 mm ²		Wire stripping length	10 mm 0.394 in
	Flexible with insulated ferrule			Tool	Flat screwdriver Ø 3.5 mm Ø 0.138 in
	Gauge	A3		Torque	0.4 - 0.6 Nm 3.5 - 5.3 lb.in
Rated current / Rated cross section	12 A / 2.5 mm ²	10 A / 12 AWG			
Rated short-time withstand current (1s)	300 A				
Rated voltage	320 V	300 V			
Impulse withstand voltage	4000 V				
Protection	IP20	NEMA 1			

The connecting capacity data for one Rigid: Solid/Stranded, or one Flexible conductor (when applicable) is a mandatory information required by IEC, UL and CSA standards (Copper conductors). All other data are provided as supplementary information only. For more details, please consult our CB, UL or CSA certificates and technical datasheet available on <http://www.TE.com>

CE	RoHS	UL	Gost R						

Accessories

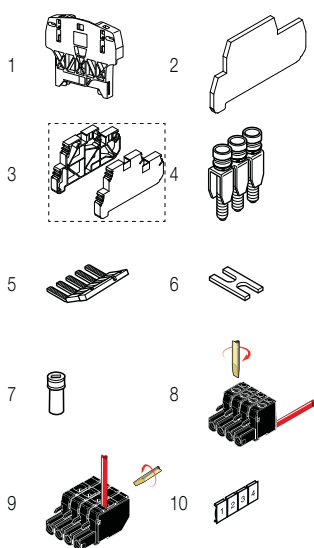

Description	Color	Type	Part Number	Pkg pce	Weight (1 pce) g	
1 End stops 10 mm 0.394 in	Dark grey <input type="checkbox"/>	BAZH1	1SNK900102R0000	20	24.00	
2 End sections 2.54 mm 0.100 in	Grey <input type="checkbox"/>	FEDCP	1SNA400825R0000	20	3.50	
3 End section-flange kit (R+L)	Grey <input type="checkbox"/>	ENS.FEDBCP	1SNA400818R0000	10	11.00	
4 Jumper bars		2 poles 24 A	BJMI5-2	1SNA176278R1600	10	3.30
		3 poles	BJMI5-3	1SNA176279R1700	10	5.00
		4 poles	BJMI5-4	1SNA176280R0500	10	6.70
		10 poles	BJMI5-10	1SNA176282R2300	10	16.90
5 Lateral jumper bars 2 poles 30 A	Grey <input type="checkbox"/>	2 poles	PC5-2	1SNA113542R1000	10	1.80
		10 poles	PC5-10	1SNA113544R1200	10	6.00
6 Cross spacing jumpers 5 mm 0.200 in - 6 mm 0.236 in - 8 mm 0.315 in		EL6	1SNA173627R2100	10	0.10	
7 Coding pegs		COCF 32	1SNA173660R1600	10	0.10	
		COC 1	1SNA299777R1600	10		
8 Female plugs wires parallel	Black <input type="checkbox"/>	2 poles	CPFT2/2	1SNA094302R2100	120	3.20
		3 poles	CPFT2/3	1SNA094303R2200	80	4.80
		4 poles	CPFT2/4	1SNA094304R2300	60	6.40
		10 poles	CPFT2/10	1SNA094310R2400	20	16.00
9 Female plugs wires perpendicular	Black <input type="checkbox"/>	2 poles	CPFT2/R-2	1SNA094352R2200	120	3.80
		3 poles	CPFT2/R-3	1SNA094353R2300	80	5.70
		4 poles	CPFT2/R-4	1SNA094354R2400	60	7.60
		10 poles	CPFT2/R-10	1SNA094360R0600	20	19.00
10 Terminal block markers Blank card	White <input type="checkbox"/>	RC510	1SNA231000R0700	1	5.20	

Complete list of accessories is indicated in the terminal block datasheet.

Some accessories such as jumper bars may modify the terminal block's ratings: complete information in the accessories catalogue pages.

Technical data valid for copper conductors only.

MA2.5/5D-2CPE pluggable terminal blocks

Double deck with 1 feed-through circuit - 5.08 mm 0.200 in spacing



2.5 mm²
12 AWG

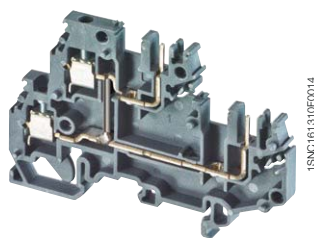

MA2.5/5D-2CPE

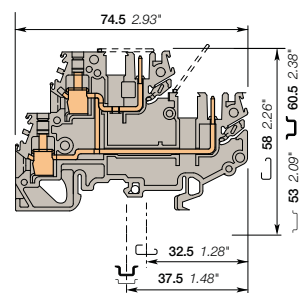

5.08 mm 0.200 in spacing

Description

- Save space with double deck terminal blocks,
- Gain in flexibility, reliability and simplicity thanks to the pluggable terminal blocks,
- Plug & play connection through pre-wired harnesses equipped with CPFT2 plugs.

Ordering details

Description	Color	Type	Part Number	Pkg pce	Weight (1 pce) g
Feed-through 1 feed-through circuit	Grey <input type="checkbox"/>	MA2.5/5.D-2CPE	1SNA400823R0000	50	12.00

Main technical data

		IEC	UL	CSA	Mounting instructions	
1 conductor per clamp	Rigid: Solid/Stranded	0.2-4 mm ²	24-12 AWG		Rail	G32, TH 35-7.5, TH 35-15
	Flexible without ferrule	0.22-2.5 mm ²			Wire stripping length	10 mm 0.394 in
	Flexible with insulated ferrule				Tool	Flat screwdriver Ø 3.5 mm Ø 0.138 in
Gauge		A3			Torque	0.4 - 0.6 Nm 3.5 - 5.3 lb.in
Rated current / Rated cross section		12 A / 2.5 mm ²	10 A / 12 AWG			
Rated short-time withstand current (1s)		300 A				
Rated voltage		320 V	300 V			
Impulse withstand voltage		4000 V				
Protection		IP20	NEMA 1			

The connecting capacity data for one Rigid: Solid/Stranded, or one Flexible conductor (when applicable) is a mandatory information required by IEC, UL and CSA standards (Copper conductors). All other data are provided as supplementary information only. For more details, please consult our CB, UL or CSA certificates and technical datasheet available on <http://www.TE.com>

CE	RoHS	UL	Gost R			

Accessories

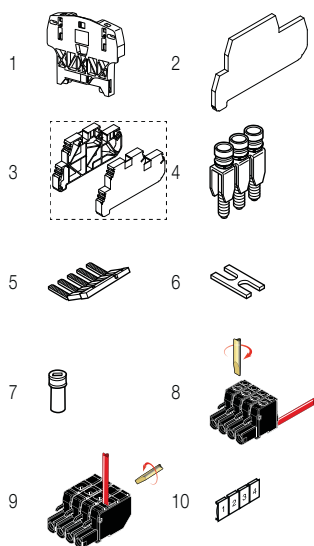

Description	Color	Type	Part Number	Pkg pce	Weight (1 pce) g
1 End stops 10 mm 0.394 in	Dark grey <input type="checkbox"/>	BAZH1	1SNK900102R0000	20	24.00
2 End sections 2.54 mm 0.100 in	Grey <input type="checkbox"/>	FEDOP	1SNA400825R0000	20	3.50
3 End section-flange kit (R+L)	Grey <input type="checkbox"/>	ENS.FEDBCP	1SNA400818R0000	10	11.00
4 Jumper bars 2 poles 24 A		BJMI5-2	1SNA176278R1600	10	3.30
3 poles		BJMI5-3	1SNA176279R1700	10	5.00
4 poles		BJMI5-4	1SNA176280R0500	10	6.70
10 poles		BJMI5-10	1SNA176282R2300	10	16.90
5 Lateral jumper bars 2 poles	Grey <input type="checkbox"/>	PC5-2	1SNA113542R1000	10	1.80
10 poles		PC5-10	1SNA113544R1200	10	6.00
6 Cross spacing jumpers 5 mm 0.200 in - 6 mm 0.236 in - 8 mm 0.315 in		EL6	1SNA173627R2100	10	0.10
7 Coding pegs		COCF 32	1SNA173660R1600	10	0.10
8 Female plugs wires parallel 5.08 mm 0.200 in 2 poles	Black <input type="checkbox"/>	CPFT2/2	1SNA094302R2100	120	3.20
3 poles		CPFT2/3	1SNA094303R2200	80	4.80
4 poles		CPFT2/4	1SNA094304R2300	60	6.40
10 poles		CPFT2/10	1SNA094310R2400	20	16.00
9 Female plugs wires perpendicular 5.08 mm 0.200 in 2 poles	Black <input type="checkbox"/>	CPFT2/R-2	1SNA094352R2200	120	3.80
3 poles		CPFT2/R-3	1SNA094353R2300	80	5.70
4 poles		CPFT2/R-4	1SNA094354R2400	60	7.60
10 poles		CPFT2/R-10	1SNA094360R0600	20	19.00
10 Terminal block markers Blank card	White <input type="checkbox"/>	RC510	1SNA231000R0700	1	5.20

Complete list of accessories is indicated in the terminal block datasheet.

Some accessories such as jumper bars may modify the terminal block's ratings: complete information in the accessories catalogue pages.

Technical data valid for copper conductors only.

MA2.5/5-SNB-CPE pluggable terminal blocks

Disconnect with blade - 5.08 mm 0.200 in spacing

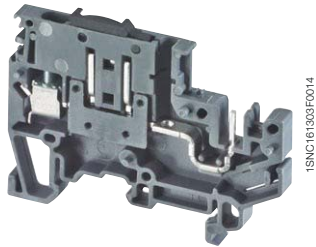

MA2.5/5-SNB-CPE

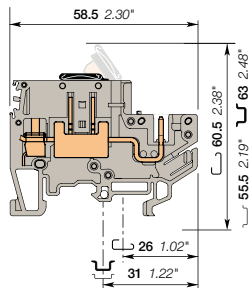

5.08 mm 0.200 in spacing

Description

- Save in flexibility, reliability and simplicity thanks to the pluggable terminal blocks,
- They are particularly well adapted to solve the connecting problems of equipment composed of sub-assemblies (complex machines such as elevators or trains, panel boards with extension boxes...),
- They can then be easily connected through patchcords with CPFT2 plugs connected to the pluggable terminal blocks outputs.

Ordering details

Description	Color	Type	Part Number	Pkg pce	Weight (1 pce) g
Disconnect 1 feed-through circuit	Grey	MA2.5/5-SNB-CPE	1SNA400815R0000	50	7.00

Main technical data

	IEC	UL	CSA
1 conductor per clamp			
Rigid: Solid/Stranded	0.2-4 mm ²	24-12 AWG	
Flexible without ferrule	0.22-2.5 mm ²		
Flexible with insulated ferrule			
Gauge	A3		
Rated current / Rated cross section	10 A / 2.5 mm ²	10 A / 12 AWG	
Rated short-time withstand current (1s)	120 A		
Rated voltage	320 V	300 V	
Impulse withstand voltage	4000 V		
Protection	IP20	NEMA 1	

Mounting instructions

Rail		G32, TH 35-7.5, TH 35-15
Wire stripping length		10 mm 0.394 in
Tool		Flat screwdriver Ø 3.5 mm Ø 0.138 in
Torque		0.4 - 0.6 Nm 3.5 - 5.3 lb.in

The connecting capacity data for one Rigid: Solid/Stranded, or one Flexible conductor (when applicable) is a mandatory information required by IEC, UL and CSA standards (Copper conductors). All other data are provided as supplementary information only. For more details, please consult our CB, UL or CSA certificates and technical datasheet available on <http://www.TE.com>

CE	RoHS	UL	Gost R							
CE	RoHS	UL	Gost R							

Accessories

Description	Color	Type	Part Number	Pkg pce	Weight (1 pce) g
1 End stops 10 mm 0.394 in	Dark grey	BAM4	1SNK900001R0000	50	14.00
5.2 mm 0.205 in		BAZ1	1SNK900002R0000	50	5.30
2 End sections 2.8 mm 0.110 in	Grey	FE2CPE	1SNA400826R0000	20	2.50
3 Lateral jumper bars 2 poles 30 A	Grey	PC5-2	1SNA113542R1000	10	1.80
10 poles		PC5-10	1SNA113544R1200	10	6.00
4 Test adapters	Blue	DCB	1SNA105028R2100	10	20.00
5 Test plugs DIA 2 mm 0.079 in	Black	FC2	1SNA007865R2600	100	
6 Coding pegs		COCF 32	1SNA173660R1600	10	0.10
		COC 1	1SNA299777R1600	10	
7 Female plugs wires parallel 5.08 mm 0.200 in	Black	CPFT2/2	1SNA094302R2100	120	3.20
		CPFT2/3	1SNA094303R2200	80	4.80
		CPFT2/4	1SNA094304R2300	60	6.40
		CPFT2/10	1SNA094310R2400	20	16.00
8 Female plugs wires perpendicular 5.08 mm 0.200 in	Black	CPFT2/R-2	1SNA094352R2200	120	3.80
		CPFT2/R-3	1SNA094353R2300	80	5.70
		CPFT2/R-4	1SNA094354R2400	60	7.60
		CPFT2/R-10	1SNA094360R0600	20	19.00
9 Terminal block markers Blank card	White	RC510	1SNA231000R0700	1	5.20

Complete list of accessories is indicated in the terminal block datasheet.

Some accessories such as jumper bars may modify the terminal block's ratings: complete information in the accessories catalogue pages.

Technical data valid for copper conductors only.

D1.5/7.ADO-CPE pluggable terminal blocks

Feed-through ADO - pluggable - 7.62 mm 0.300 in spacing

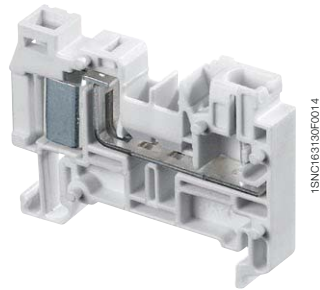

D1.5/7.ADO-CPE

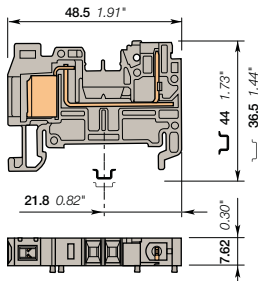

7.62 mm 0.300 in spacing

Description

- Disconnect terminal blocks allow easy opening, maintenance and current or voltage testing without disconnecting the wiring,
- With the TE Connectivity ADO System®, experience the fastest and most reliable connection on the market,
- Designed for control applications exposed to severe constraints (vibrations, shocks, corrosion etc.),
- Up to 2 wires per connection.

Ordering details

Description	Color	Type	Part Number	Pkg pce	Weight (1 pce) g
Feed-through 1 ADO, 1 pluggable	Grey	D1.5/7.ADO-CPE	1SNA290486R2700	50	

Main technical data

		IEC	UL	CSA	Mounting instructions	
ADO	Rigid: Solid/Stranded	0.34-1.5 mm²	22-16 AWG		Rail	TH 35-7.5, TH 35-15
	Flexible without ferrule	0.34-2.5 mm²			Wire stripping length	
Screw clamp	Rigid: Solid/Stranded				Tool	
	Flexible without ferrule					
	Flexible with insulated ferrule					
Gauge					Torque	
Rated current / Rated cross section		16 A / 1.5 mm²	15 A / 16 AWG			
Rated short-time withstand current (1s)		180 A				
Rated voltage		500 V	300 V			
Impulse withstand voltage						
Protection		IP20	NEMA 1			

The connecting capacity data for one Rigid: Solid/Stranded, or one Flexible conductor (when applicable) is a mandatory information required by IEC, UL and CSA standards (Copper conductors). All other data are provided as supplementary information only. For more details, please consult our CB, UL or CSA certificates and technical datasheet available on <http://www.TE.com>



Notes

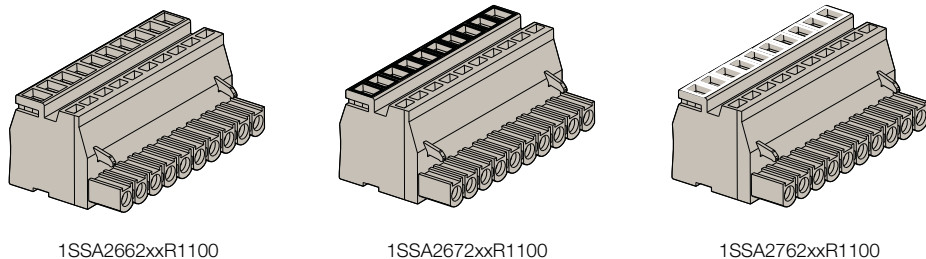

Accessories

Description	Color	Type	Part Number	Pkg pce	Weight (1 pce) g	
1 End stops	Dark grey	BAM4	1SNK900001R0000	50	14.00	
		BAZ1	1SNK900002R0000	50	5.30	
2 Jumper bars		2 poles	BJE762.2	1SNA290451R0300	10	5.30
		5 poles	BJE762.5	1SNA290452R0400	10	15.40
		10 poles	BJE762.10	1SNA290453R0500	10	24.00
3 Insulating tips	Orange	EIP	1SNA290454R0600	10	100.00	
4 Locking devices	Black	VRADO.CPE7	1SNA400063R0000	20	0.40	
5 Coding pegs	Yellow	COCE	1SNA199321R2100	10	1.00	
6 Tools		Semi automatic tool	OUPAD	1SNA178944R0400	1	205.00
		Hand tool	OUMAD	1SNA179466R0600	1	29.00
7 Terminal block markers	White	Blank card	RB-12W7	1SNA290455R0700	50	6.00

Complete list of accessories is indicated in the terminal block datasheet.

Some accessories such as jumper bars may modify the terminal block's ratings: complete information in the accessories catalogue pages.

Technical data valid for copper conductors only.

D2.5/7.ADO-CPE pluggable terminal blocks

Feed-through ADO - pluggable - 7.62 mm 0.300 in spacing



D2.5/7.ADO-CPE

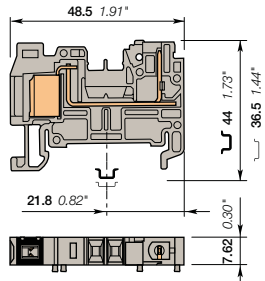

7.62 mm 0.300 in spacing

Description

- Disconnect terminal blocks allow easy opening, maintenance and current or voltage testing without disconnecting the wiring,
- With the TE Connectivity ADO System®, experience the fastest and most reliable connection on the market,
- Designed for control applications exposed to severe constraints (vibrations, shocks, corrosion etc.),
- Up to 2 wires per connection.

Ordering details

Description	Color	Type	Part Number	Pkg pce	Weight (1 pce) g
Feed-through 1 ADO, 1 pluggable with black marking for wire size 1-2.5 mm² (16-14 AWG)	Grey <input type="checkbox"/>	D2.5/7.ADO-CPE	1SNA290483R2400	50	8.40

Main technical data

		IEC	UL	CSA	Mounting instructions	
ADO	Rigid: Solid/Stranded Flexible without ferrule	1-2.5 mm² 1-2.5 mm²	16-14 AWG		Rail	TH 35-7.5, TH 35-15
Screw clamp	Rigid: Solid/Stranded Flexible without ferrule Flexible with insulated ferrule Gauge				Wire stripping length	
Rated current / Rated cross section		24 A / 2.5 mm²	15 A / 14 AWG		Tool	
Rated short-time withstand current (1s)		300 A			Torque	
Rated voltage		500 V	300 V			
Impulse withstand voltage						
Protection		IP20	NEMA 1			

The connecting capacity data for one Rigid: Solid/Stranded, or one Flexible conductor (when applicable) is a mandatory information required by IEC, UL and CSA standards (Copper conductors). All other data are provided as supplementary information only. For more details, please consult our CB, UL or CSA certificates and technical datasheet available on <http://www.TE.com>



Notes

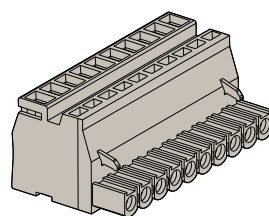

1SSA2662xxR1100

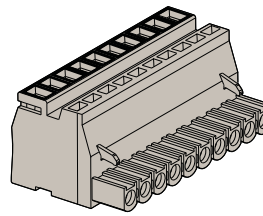

1SSA2672xxR1100

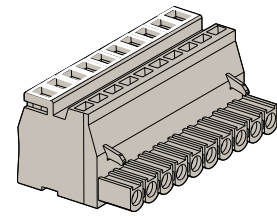

1SSA2762xxR1100

Accessories

Description	Color	Type	Part Number	Pkg pce	Weight (1 pce) g	
1 End stops	Dark grey <input type="checkbox"/>	BAM4	1SNK900001R0000	50	14.00	
		BAZ1	1SNK900002R0000	50	5.30	
2 Jumper bars		2 poles	BJE762.2	10	5.30	
		5 poles	BJE762.5	10	15.40	
		10 poles	BJE762.10	10	24.00	
3 Insulating tips	Orange <input type="checkbox"/>	EIP	1SNA290454R0600	10	100.00	
4 Locking devices	Black <input type="checkbox"/>	VRADO.CPE7	1SNA400063R0000	20	0.40	
5 Coding pegs	Yellow <input type="checkbox"/>	COCE	1SNA199321R2100	10	1.00	
6 Tools		Semi automatic tool	OUPAD	1SNA178944R0400	1	205.00
		Hand tool	OUMAD	1SNA179466R0600	1	29.00
7 Terminal block markers	White <input type="checkbox"/>	RB-12W7	1SNA290455R0700	50	6.00	

Complete list of accessories is indicated in the terminal block datasheet.

Some accessories such as jumper bars may modify the terminal block's ratings: complete information in the accessories catalogue pages.

Technical data valid for copper conductors only.

D1.5/7.2ADO-CPE pluggable terminal blocks

Feed-through ADO - pluggable - 7.62 mm 0.300 in spacing

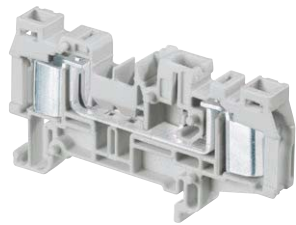

1SNK16313F0014

D1.5/7.2ADO-CPE

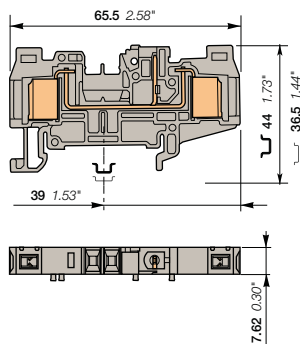

7.62 mm 0.300 in spacing

Description

- Disconnect terminal blocks allow easy opening, maintenance and current or voltage testing without disconnecting the wiring,
- With the TE Connectivity ADO System®, experience the fastest and most reliable connection on the market,
- Designed for control applications exposed to severe constraints (vibrations, shocks, corrosion etc.),
- Up to 2 wires per connection.

Ordering details

Description	Color	Type	Part Number	Pkg pce	Weight (1 pce) g
Feed-through 2 ADO, 1 pluggable	Grey	D1.5/7.2ADO-CPE	1SNA290487R2000	50	

Main technical data

		IEC	UL	CSA	Mounting instructions	
ADO		Rigid: Solid/Stranded Flexible without ferrule Flexible with ferrule	22-16 AWG		Rail	TH 35-7.5, TH 35-15
Screw clamp		Rigid: Solid/Stranded Flexible without ferrule Flexible with insulated ferrule Gauge			Wire stripping length	
Rated current / Rated cross section		16 A / 1.5 mm²	15 A / 16 AWG		Tool	
Rated short-time withstand current (1s)		180 A			Torque	
Rated voltage		500 V	300 V			
Impulse withstand voltage						
Protection		IP20	NEMA 1			

The connecting capacity data for one Rigid: Solid/Stranded, or one Flexible conductor (when applicable) is a mandatory information required by IEC, UL and CSA standards (Copper conductors). All other data are provided as supplementary information only. For more details, please consult our CB, UL or CSA certificates and technical datasheet available on <http://www.TE.com>

RoHS	UL	CSA	Gost R
RoHS	UL	CSA	Gost R

Notes

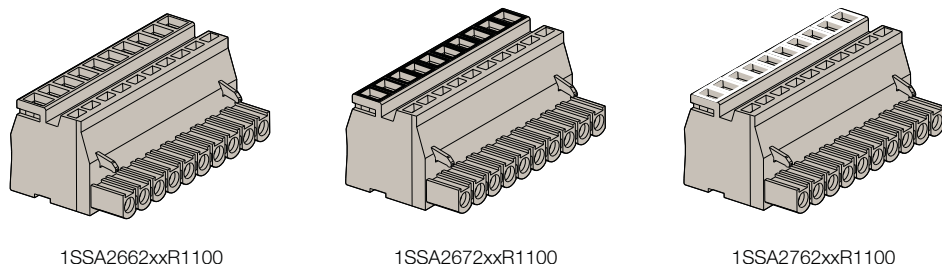

Accessories

Description	Color	Type	Part Number	Pkg pce	Weight (1 pce) g
1 End stops	Dark grey	BAM4	1SNK900001R0000	50	14.00
		BAZ1	1SNK900002R0000	50	5.30
2 End sections	Grey	FECPE.2ADO	1SNA291833R1700	20	2.50
3 Jumper bars		BJE762.2	1SNA290451R0300	10	5.30
		BJE762.5	1SNA290452R0400	10	15.40
		BJE762.10	1SNA290453R0500	10	24.00
4 Insulating tips	Orange	EIP	1SNA290454R0600	10	100.00
5 Locking devices	Black	VRADO.CPE7	1SNA400063R0000	20	0.40
6 Coding pegs	Yellow	COCE	1SNA199321R2100	10	1.00
7 Tools		Semi automatic tool	OUPAD	1	205.00
		Hand tool	OUMAD	1	29.00
8 Terminal block markers	White	RB-12W7	1SNA290455R0700	50	6.00

Complete list of accessories is indicated in the terminal block datasheet. Some accessories such as jumper bars may modify the terminal block's ratings: complete information in the accessories catalogue pages.

Technical data valid for copper conductors only.

D2.5/7.2ADO-CPE pluggable terminal blocks

Feed-through ADO - pluggable - 7.62 mm 0.300 in spacing

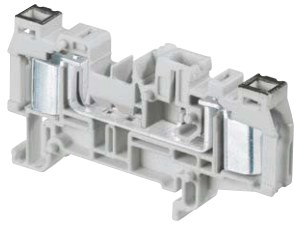

D2.5/7.2ADO-CPE

Description

- Disconnect terminal blocks allow easy opening, maintenance and current or voltage testing without disconnecting the wiring,
- With the TE Connectivity ADO System®, experience the fastest and most reliable connection on the market,
- Designed for control applications exposed to severe constraints (vibrations, shocks, corrosion etc.),
- Up to 2 wires per connection.

Ordering details

Description	Color	Type	Part Number	Pkg pce	Weight (1 pce) g
Feed-through 2 ADO, 1 pluggable with black marking for wire size 1-2.5 mm² (16-14 AWG)	Grey <input type="checkbox"/>	D2.5/7.2ADO-CPE	1SNA290484R2500	50	11.00

Main technical data

		IEC	UL	CSA	Mounting instructions	
ADO	Rigid: Solid/Stranded Flexible without ferrule	1-2.5 mm² 1-2.5 mm²	16-14 AWG		Rail	TH 35-7.5, TH 35-15
Screw clamp	Rigid: Solid/Stranded Flexible without ferrule Flexible with insulated ferrule Gauge				Wire stripping length	
Rated current / Rated cross section		24 A / 2.5 mm²	15 A / 14 AWG		Tool	
Rated short-time withstand current (1s)		300 A			Torque	
Rated voltage		500 V	300 V			
Impulse withstand voltage						
Protection		IP20	NEMA 1			

The connecting capacity data for one Rigid: Solid/Stranded, or one Flexible conductor (when applicable) is a mandatory information required by IEC, UL and CSA standards (Copper conductors). All other data are provided as supplementary information only. For more details, please consult our CB, UL or CSA certificates and technical datasheet available on <http://www.TE.com>

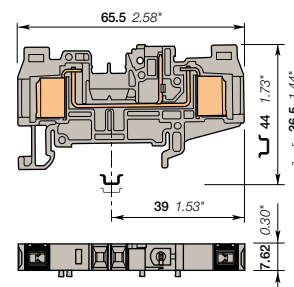

7.62 mm 0.300 in spacing

Notes

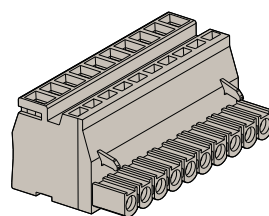

1SSA2662xxR1100

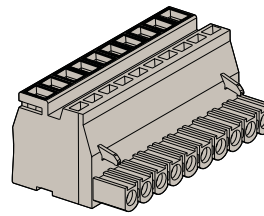

1SSA2672xxR1100

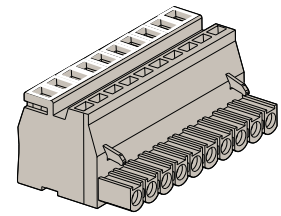

1SSA2762xxR1100

Accessories

Description	Color	Type	Part Number	Pkg pce	Weight (1 pce) g
1 End stops	Dark grey <input type="checkbox"/>	BAM4	1SNK900001R0000	50	14.00
		BAZ1	1SNK900002R0000	50	5.30
2 End sections	Grey <input type="checkbox"/>	FECPE.2ADO	1SNA291833R1700	20	2.50
3 Jumper bars		BJE762.2	1SNA290451R0300	10	5.30
		5 poles	BJE762.5	10	15.40
		10 poles	BJE762.10	10	24.00
4 Insulating tips	Orange <input type="checkbox"/>	EIP	1SNA290454R0600	10	100.00
5 Locking devices	Black <input type="checkbox"/>	VRADO.CPE7	1SNA400063R0000	20	0.40
6 Coding pegs	Yellow <input type="checkbox"/>	COCE	1SNA199321R2100	10	1.00
7 Tools		Semi automatic tool	OUPAD	1	205.00
		Hand tool	OUMAD	1	29.00
8 Terminal block markers	White <input type="checkbox"/>	Blank card	RB-12W7	50	6.00

Complete list of accessories is indicated in the terminal block datasheet.

Some accessories such as jumper bars may modify the terminal block's ratings: complete information in the accessories catalogue pages.

Technical data valid for copper conductors only.



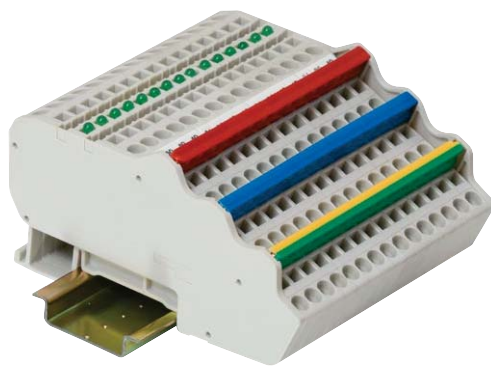

1SNC160101S0201

Dedicated applications terminal blocks

Sensors / Actuators



Technologies presentation	190
Overview	191

Screw clamp technology

2 wire sensor

2.5 mm ² / 12 AWG	D2.5/6.DP	192
------------------------------	-----------	-----

3 wire sensor

2.5 mm ² / 12 AWG	D2.5/6.DA	193	
	D2.5/6.D	194	
	D2.5/6.DL	With red led	195
	D2.5/6.DAL	With green led	196

Thermocouple

MTC6	197
------	-----

Spring clamp technology

3 wire sensor

1.5 mm ² / 16 AWG	D2.5/5.C3.L	198	
	D2.5/5.C3.L.L	With green led	199

4 wire sensor

1.5 mm ² / 16 AWG	D2.5/5.C4.L	200	
	D2.5/5.C4.L.L	With green led	201

ADO-ADO technology

3 wire sensor

1 mm ² / 20 AWG	D1/5.C3.ADO	202	
	D1/5.C3.ADO.L	With green led	203

4 wire sensor

1 mm ² / 20 AWG	D1/5.C4.ADO	204	
	D1/5.C4.ADO.L	With green led	205

Dedicated applications terminal blocks

Sensors / Actuators

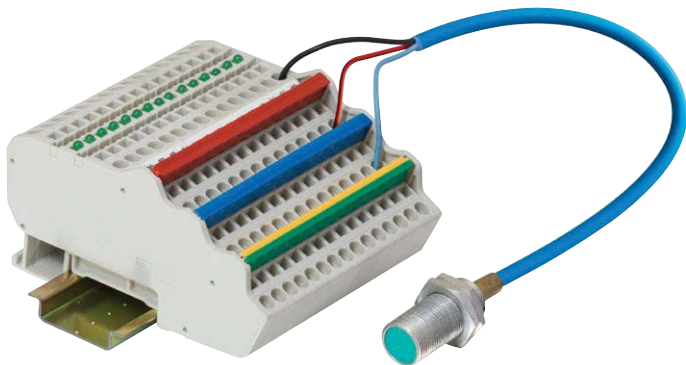

The smart choice for process automation applications

Process automation applications typically require the use of a large number of digital or analog signals and sensors. The space constraint is often an issue in regards to this large volume of signals to handle.

TE Connectivity sensor and actuator terminal blocks reduce the installation costs, speed the wiring and ease commissioning thanks to:

- Compact multi deck terminals blocks for 3 & 4 wire sensors
- Potentials distribution via jumper (positive, negative, ground)
- Signal indication via LED for circuit status indication.

Select from our large choice of solutions and technologies

Classic and compact screw clamp terminal blocks

The product family features very compact dimensions. It is the preferred choice for small junction boxes when panel height is a constraints. Our terminals are compatible with:

- 2 wire and 3 wire sensors
- PNP & NPN sensors.

Convenient and ergonomic spring clamp terminal blocks

The product family features popular spring technology particularly appreciated in process industry.

Our product family offers:

- Compatibility with 2, 3 and 4 wire sensors
- Compatibility: with NPN and PNP sensors thanks to bidirectional LED indicators
- Color coded 34 poles plug-in jumpers adapted to popular PLC I/O cards configurations (8, 16, 32 channels).

ADO System® terminal blocks: experience the fastest and most reliable connection on the market

Our exclusive ADO System® combines speed on connection with top reliability of connection. Our product family offers:

- Compatibility with 2, 3 and 4 wire sensors
- Compatibility: with NPN and PNP sensors thanks to bidirectional LED indicators
- Color coded 66 poles plug-in jumpers adapted to all PLC I/O cards configurations (8,16, 32 & 64 channels).

Universal thermocouple terminal block

This terminal block allows connection of all types of temperature thermocouple sensors. Its exclusive design allows thermocouple wire extension with no loss of signal integrity.

Learn more in the related page of our catalog.



Screw clamp terminal block



Spring terminal block



ADO System® terminal block



Thermocouple terminal block

15NC161167S0201

Dedicated applications terminal blocks

Sensors / Actuators

Screw clamp technology



Section		2 wire sensor		3 wire sensor			Thermocouple
IEC	UL/CSA						
2.5 mm²	12 AWG	D2.5/6.DP 6 mm 0.236 in	D2.5/6.DA 6 mm 0.236 in	D2.5/6.D 6 mm 0.236 in	D2.5/6.DL 6 mm 0.236 in	D2.5/6.DAL 6 mm 0.236 in	MTC6 6 mm 0.236 in

Spring clamp technology



Section		3 wire sensor		4 wire sensor	
IEC	UL/CSA				
1.5 mm²	16 AWG	D2.5/5.C3.L 5 mm 0.197 in	D2.5/5.C3.L.L 5 mm 0.197 in	D2.5/5.C4.L 5 mm 0.197 in	D2.5/5.C4.L.L 5 mm 0.197 in

ADO-ADO technology



Section		3 wire sensor		4 wire sensor	
IEC	UL/CSA				
1 mm²	20 AWG	D1/5.C3.ADO 5 mm 0.197 in	D1/5.C3.ADO.L 5 mm 0.197 in	D1/5.C4.ADO 5 mm 0.197 in	D1/5.C4.ADO.L 5 mm 0.197 in

D2.5/6.DP screw clamp terminal blocks

Double deck + ground - 6 mm 0.236 in spacing

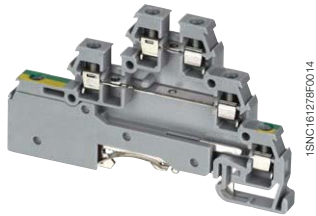

D2.5/6.DP

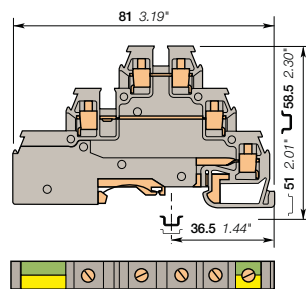

6 mm 0.236 in spacing

Description

- Save space with triple deck terminal blocks: 2 independent circuits in just 6 mm 0.236 in spacing,
- Adapted for 2 wires sensor/actuator with ground.

Ordering details

Description	Color	Type	Part Number	Pkg qty	Weight (1 pce)
Feed-through + ground For 2 wires sensor with ground - 2 feed-through circuits - 1 ground circuit	Grey, Green-Yellow	D2.5/6.DPA1	1SNA115643R2700	25	16.00

Main technical data

Connecting capacity		IEC	UL	CSA	Mounting instructions	
1 conductor per clamp	Rigid: Solid/Stranded	0.2-2.5 mm ²	20-12 AWG	22-14 AWG	Rail	G32, TH 35-7.5, TH 35-15
	Flexible without ferrule	0.22-2.5 mm ²			Wire stripping length	6 mm 0.24 in
	Flexible with insulated ferrule				Tool	Flat screwdriver Ø 3.5 mm Ø 0.138 in
	Gauge	A2			Torque	0.4 - 0.6 N.m 3.5 - 5.3 lb.in
Rated current / Rated cross section		22 A / 2.5 mm ²	26 A / 12 AWG	20 A / 14 AWG		
Rated short-time withstand current (1s)		300 A				
Rated voltage		380 V	300 V	300 V		
Impulse withstand voltage						
Protection		IP20	NEMA 1			

The connecting capacity data for one Rigid: Solid/Stranded, or one Flexible conductor (when applicable) is a mandatory information required by IEC, UL and CSA standards (Copper conductors). All other data are provided as supplementary information only. For more details, please consult our CB, UL or CSA certificates and technical datasheet available on <http://www.TE.com>

--	--	--	--	--	--	--	--	--	--	--	--	--	--	--	--	--	--	--	--

Accessories

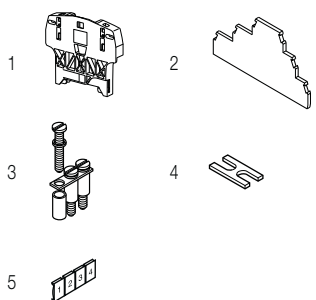

Description	Color	Type	Part Number	Pkg qty	Weight (1 pce)
1 End stops 10 mm 0.394 in	Dark grey	BAZH1	1SNK900102R0000	20	24.00
2 End sections 3 mm 0.118 in	Grey	FED3E	1SNA116771R2000	20	3.80
3 Jumper bars 2 poles 22 A		BJD6	1SNA178024R2500	10	1.00
			1SNA178025R2600	10	2.00
			1SNA178026R2700	10	2.00
			1SNA178027R2000	10	3.00
			1SNA178032R2500	10	6.00
			1SNA178033R2600	5	12.00
4 Cross spacing jumpers 5 mm 0.200 in - 6 mm 0.236 in - 8 mm 0.315 in		EL61	1SNA177812R1700	10	0.10
5 Terminal block markers Blank card	White	RC65	1SNA232000R0000	1	3.60

Complete list of accessories is indicated in the terminal block datasheet. Some accessories such as jumper bars may modify the terminal block's ratings: complete information in the accessories catalogue pages.

Technical data valid for copper conductors only.

D2.5/6.DA screw clamp terminal blocks

Triple deck - 6 mm 0.236 in spacing



D2.5/6.DA

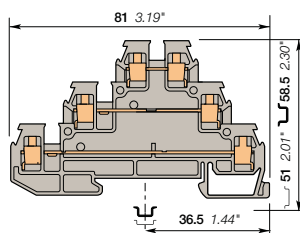

6 mm 0.236 in spacing

Description

- Save space with triple deck terminal blocks: 3 independent circuits connected in just 6 mm 0.236 in spacing,
- Adapted for 3 wires sensor/actuator.

Ordering details

Description	Color	Type	Part Number	Pkg qty	Weight (1 pce) g
Feed-through For 3 wires sensor - 3 feed-through circuits	Grey <input type="checkbox"/>	D2.5/6.DA	1SNA115541R1100	25	13.00

Main technical data

Connecting capacity		IEC	UL	CSA
1 conductor per clamp	Rigid: Solid/Stranded	0.2-2.5 mm ²	20-12 AWG	22-14 AWG
	Flexible without ferrule	0.22-2.5 mm ²		
	Flexible with insulated ferrule			
	Gauge	A2		
Rated current / Rated cross section		22 A / 2.5 mm ²	26 A / 12 AWG	20 A / 14 AWG
Rated short-time withstand current (1s)		300 A		
Rated voltage		380 V	300 V	300 V
Impulse withstand voltage				
Protection		IP20	NEMA 1	

Mounting instructions

Rail		G32, TH 35-7.5, TH 35-15
Wire stripping length		6 mm 0.24 in
Tool		Flat screwdriver Ø 3.5 mm Ø 0.138 in
Torque		0.4 - 0.6 N.m 3.5 - 5.3 lb.in

The connecting capacity data for one Rigid: Solid/Stranded, or one Flexible conductor (when applicable) is a mandatory information required by IEC, UL and CSA standards (Copper conductors). All other data are provided as supplementary information only, for more details, please consult our CB, UL or CSA certificates and technical datasheet available on <http://www.TE.com>

CE	RoHS	USR	CSA	Gost R

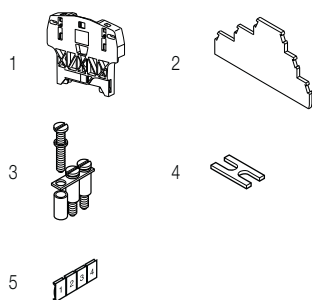

Accessories

Description	Color	Type	Part Number	Pkg qty	Weight (1 pce) g
1 End stops 10 mm 0.394 in	Dark grey <input type="checkbox"/>	BAZH1	1SNK900102R0000	20	24.00
2 End sections 3 mm 0.118 in	Grey <input type="checkbox"/>	FED3E	1SNA116771R2000	20	3.80
3 Jumper bars 2 poles 22 A		BJD6	1SNA178024R2500	10	1.00
			1SNA178025R2600	10	2.00
			1SNA178026R2700	10	2.00
			1SNA178027R2000	10	3.00
			1SNA178032R2500	10	6.00
			1SNA178033R2600	5	12.00
4 Cross spacing jumpers 5 mm 0.200 in - 6 mm 0.236 in - 8 mm 0.315 in		EL61	1SNA177812R1700	10	0.10
5 Terminal block markers Blank card	White <input type="checkbox"/>	RC65	1SNA232000R0000	1	3.60

Complete list of accessories is indicated in the terminal block datasheet.

Some accessories such as jumper bars may modify the terminal block's ratings: complete information in the accessories catalogue pages.

Technical data valid for copper conductors only.

D2.5/6.D screw clamp terminal blocks

Sensors / Actuators - 6 mm 0.236 in spacing

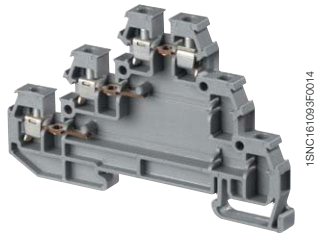

D2.5/6.D

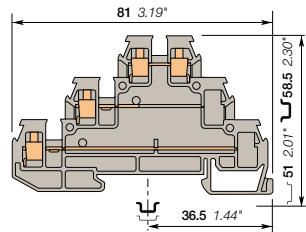

6 mm 0.236 in spacing

Description

Save space with triple deck terminal blocks: adapted for 3 wires sensor/actuator in just 6 mm 0.236 in spacing.

Ordering details

Description	Color	Type	Part Number	Pkg pce	Weight (1 pce) g
Sensor	Grey <input type="checkbox"/>	D2.5/6.D	1SNA115542R1200	25	10.00

Main technical data

	IEC	UL	CSA	Mounting instructions	
1 conductor per clamp	Rigid: Solid/Stranded Flexible without ferrule Flexible with insulated ferrule Gauge	0.2-2.5 mm ² 0.22-2.5 mm ² A2	20-12 AWG	22-14 AWG	Rail G32, TH 35-7.5, TH 35-15 Wire stripping length 6 mm 0.24 in Tool Flat screwdriver Ø 3.5 mm Ø 0.138 in Torque 0.4 - 0.6 Nm 3.5 - 5.3 lb.in
Rated current / Rated cross section	22 A / 2.5 mm ²	26 A / 12 AWG	20 A / 14 AWG		
Rated short-time withstand current (1s)	300 A				
Rated voltage	380 V	300 V	300 V		
Impulse withstand voltage					
Protection	IP20	NEMA 1			

The connecting capacity data for one Rigid: Solid/Stranded, or one Flexible conductor (when applicable) is a mandatory information required by IEC, UL and CSA standards (Copper conductors). All other data are provided as supplementary information only. For more details, please consult our CB, UL or CSA certificates and technical datasheet available on <http://www.TE.com>

CE	RoHS	USR	CSA	Gost R
----	------	-----	-----	--------

Accessories

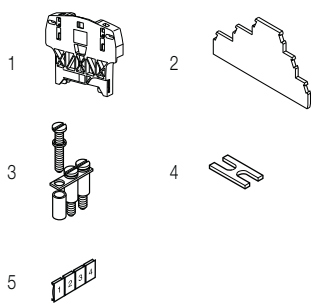

Description	Color	Type	Part Number	Pkg pce	Weight (1 pce) g
1 End stops	Dark grey <input checked="" type="checkbox"/>	BAZH1	1SNK900102R0000	20	24.00
2 End sections	Grey <input type="checkbox"/>	FED3E	1SNA116771R2000	20	3.80
3 Jumper bars		BJD6	1SNA178024R2500	10	1.00
3 poles			1SNA178025R2600	10	2.00
4 poles			1SNA178026R2700	10	2.00
5 poles			1SNA178027R2000	10	3.00
10 poles			1SNA178032R2500	10	6.00
20 poles			1SNA178033R2600	5	12.00
4 Cross spacing jumpers		EL61	1SNA177812R1700	10	0.10
5 Terminal block markers	White <input type="checkbox"/>	RC65	1SNA232000R0000	1	3.60

Complete list of accessories is indicated in the terminal block datasheet. Some accessories such as jumper bars may modify the terminal block's ratings: complete information in the accessories catalogue pages.

Technical data valid for copper conductors only.

D2.5/6.D screw clamp terminal blocks

Sensors / Actuators - 6 mm 0.236 in spacing

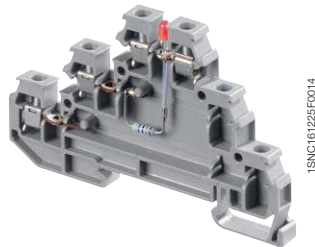
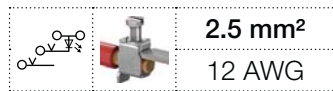

D2.5/6.D

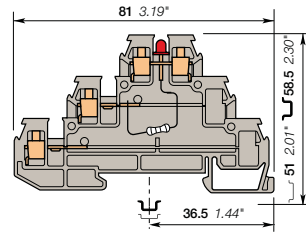

6 mm 0.236 in spacing

Description

- Save space with triple deck terminal blocks: adapted for 3 wires sensor/actuator in just 6 mm 0.236 in spacing,
- Quickly identify the signal circuit status thanks to the indicator.

Ordering details

Description	Color	Type	Part Number	Pkg pce	Weight (1 pce) g
Sensor For 3 wire sensor PNP with red 24 V DC LED and a jumper bar channel on middle and lower deck	Grey <input type="checkbox"/>	D2.5/6.DL	1SNA115537R0500	25	10.00

Main technical data

		IEC	UL	CSA
1 conductor per clamp	Rigid: Solid/Stranded	0.2-2.5 mm ²	20-12 AWG	22-14 AWG
	Flexible without ferrule	0.22-2.5 mm ²		
	Flexible with insulated ferrule			
	Gauge	A2		
Rated current / Rated cross section		22 A / 2.5 mm ²	26 A / 12 AWG	20 A / 14 AWG
Rated short-time withstand current (1s)		300 A		
Rated voltage		380 V	300 V	300 V
Impulse withstand voltage				
Protection		IP20	NEMA 1	

Mounting instructions

Rail		G32, TH 35-7.5, TH 35-15
Wire stripping length		6 mm 0.24 in
Tool		Flat screwdriver Ø 3.5 mm Ø 0.138 in
Torque		0.4 - 0.6 Nm 3.5 - 5.3 lb.in

The connecting capacity data for one Rigid: Solid/Stranded, or one Flexible conductor (when applicable) is a mandatory information required by IEC, UL and CSA standards (Copper conductors). All other data are provided as supplementary information only. For more details, please consult our CB, UL or CSA certificates and technical datasheet available on <http://www.TE.com>

--	--	--	--	--

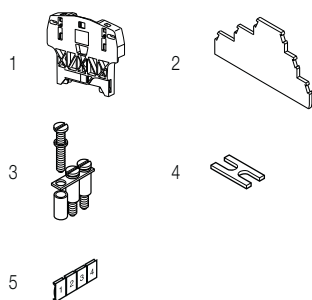

Accessories

Description	Color	Type	Part Number	Pkg pce	Weight (1 pce) g
1 End stops 10 mm 0.394 in	Dark grey <input type="checkbox"/>	BAZH1	1SNK900102R0000	20	24.00
2 End sections 3 mm 0.118 in	Grey <input type="checkbox"/>	FED3E	1SNA116771R2000	20	3.80
3 Jumper bars 2 poles 22 A		BJD6	1SNA178024R2500	10	1.00
			1SNA178025R2600	10	2.00
			1SNA178026R2700	10	2.00
			1SNA178027R2000	10	3.00
			1SNA178032R2500	10	6.00
			1SNA178033R2600	5	12.00
4 Cross spacing jumpers 5 mm 0.200 in - 6 mm 0.236 in - 8 mm 0.315 in		EL61	1SNA177812R1700	10	0.10
5 Terminal block markers Blank card	White <input type="checkbox"/>	RC65	1SNA232000R0000	1	3.60

Complete list of accessories is indicated in the terminal block datasheet.

Some accessories such as jumper bars may modify the terminal block's ratings: complete information in the accessories catalogue pages.

Technical data valid for copper conductors only.

D2.5/6.DAL screw clamp terminal blocks

Sensors / Actuators - 6 mm 0.236 in spacing

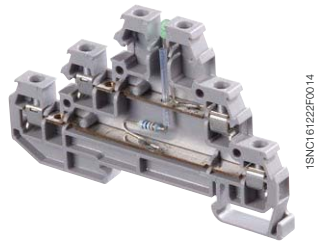

D2.5/6.DAL

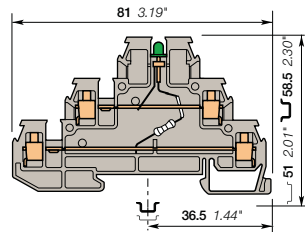

6 mm 0.236 in spacing

Description

- Save space with triple deck terminal blocks: 2 independent circuits connected in just 6 mm 0.236 in spacing,
- Adapted for 3 wires sensor/actuator,
- Quickly identify the signal circuit status thanks to the indicator.

Ordering details

Description	Color	Type	Part Number	Pkg pce	Weight (1 pce)
Sensor Power block with green LED 24 V DC for 3 wires sensor and a jumper bar	Grey <input type="checkbox"/>	D2.5/6.DAL2	1SNA115547R1700	25	12.00

Main technical data

	IEC	UL	CSA
1 conductor per clamp	Rigid: Solid/Stranded Flexible without ferrule Flexible with insulated ferrule Gauge	0.2-2.5 mm ² 0.22-2.5 mm ² A2	20-12 AWG 22-14 AWG
Rated current / Rated cross section	22 A / 2.5 mm ²	26 A / 12 AWG	20 A / 14 AWG
Rated short-time withstand current (1s)	300 A		
Rated voltage	380 V	300 V	300 V
Impulse withstand voltage			
Protection	IP20	NEMA 1	

Mounting instructions

Rail		G32, TH 35-7.5, TH 35-15
Wire stripping length		6 mm 0.24 in
Tool		Flat screwdriver Ø 3.5 mm Ø 0.138 in
Torque		0.4 - 0.6 Nm 3.5 - 5.3 lb.in

The connecting capacity data for one Rigid: Solid/Stranded, or one Flexible conductor (when applicable) is a mandatory information required by IEC, UL and CSA standards (Copper conductors). All other data are provided as supplementary information only. For more details, please consult our CB, UL or CSA certificates and technical datasheet available on <http://www.TE.com>

CE	RoHS	UL	CSA	Gost R

Accessories

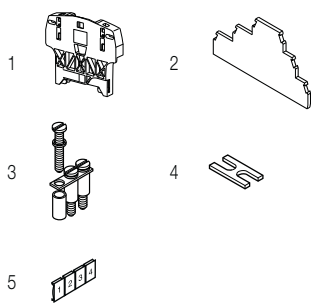

Description	Color	Type	Part Number	Pkg pce	Weight (1 pce)
1 End stops 10 mm 0.394 in	Dark grey <input type="checkbox"/>	BAZH1	1SNK900102R0000	20	24.00
2 End sections 3 mm 0.118 in	Grey <input type="checkbox"/>	FED3E	1SNA116771R2000	20	3.80
3 Jumper bars 2 poles 22 A		BJD6	1SNA178024R2500	10	1.00
3 poles			1SNA178025R2600	10	2.00
4 poles			1SNA178026R2700	10	2.00
5 poles			1SNA178027R2000	10	3.00
10 poles			1SNA178032R2500	10	6.00
20 poles			1SNA178033R2600	5	12.00
4 Cross spacing jumpers 5 mm 0.200 in - 6 mm 0.236 in - 8 mm 0.315 in		EL61	1SNA177812R1700	10	0.10
5 Terminal block markers Blank card	White <input type="checkbox"/>	RC65	1SNA232000R0000	1	3.60

Complete list of accessories is indicated in the terminal block datasheet. Some accessories such as jumper bars may modify the terminal block's ratings: complete information in the accessories catalogue pages.

Technical data valid for copper conductors only.

MTC6 thermocouple terminal blocks

Screw clamp - 6 mm 0.236 in spacing

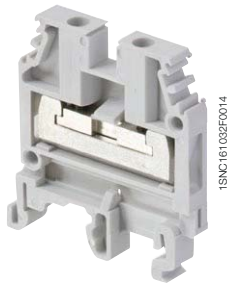

MTC6

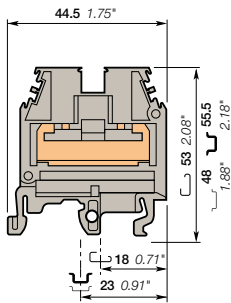

6 mm 0.236 in spacing

Description

- Universal terminal block adapted to all type of thermocouples,
- Allow thermocouple wire extension with no loss of signal integrity,
- Compatible with solid type thermocouple wires,
- Reduced inventory: only one part number needed for all configurations.

Ordering details

Description	Color	Type	Part Number	Pkg pce	Weight (1 pce) g
Feed-through	Grey	MTC6	1SNA115206R2200	50	20
		MTC6.Ex	1SNA146227R2500	50	20

Main technical data

	NFC	DIN		
Wire size	2 rigid thermocouple conductors 0.9 to 1.5		Rail	G32, TH 35-7.5, TH 35-15
Rated voltage	500 V		Wire stripping length	31 mm 1.22 in
Rated voltage Ex e (MTC6.Ex)	550 V IEC/EN 60079-7 - IM2/M1 II 2 GD/1 GD Ex e I/II		Torque	0.4 - 0.6 N.m 3.5 - 5.3 lb.in

Mounting instructions

The connecting capacity data for one Rigid: Solid/Stranded, or one Flexible conductor (when applicable) is a mandatory information required by IEC, UL and CSA standards (Copper conductors). All other data are provided as supplementary information only. For more details, please consult our CB, UL or CSA certificates and technical datasheet available on <http://www.TE.com>

RoHS	RoHS	PC	Gost R
------	------	----	--------

Notes

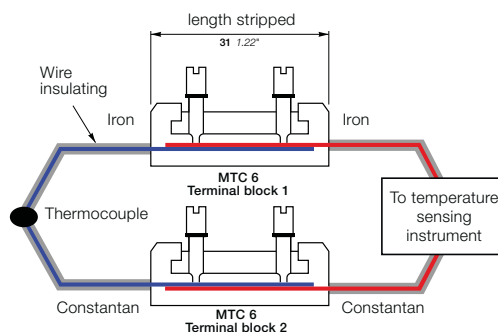

Figure 1: MTC6 with shield connector

Universal terminal block

Other thermocouple terminal blocks are available with hardware (screws, clamps and connecting bar) which match the thermocouple material being used. This requires inventory of many different terminal block types.

MTC6 terminal block adapts to all thermocouple material. This "neutral" method of connection limits the introduction of foreign materials to an insignificant level. The thermocouple wire insulation is stripped (31 mm maximum) and the bar wires are superimposed on each another. The thermocouple wires are in contact over their complete 31 mm length and tightened at two points by round tip screws (see figure 1). The screws, made of plated brass, have only a mechanical function, that of holding the wires together with a point contact. Thus, the pressure points are not relevant in the connection environment. One thermocouple lead connects through one terminal block (see figure 1). The MTC6 requires only 6 mm of space, allowing 50 terminals per foot of rail.

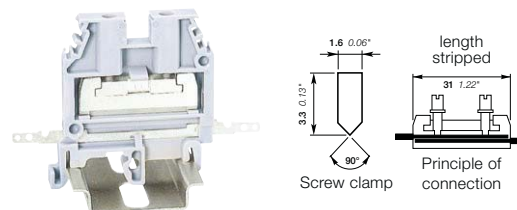

Figure 2

Thermocouple shield wire connector bar

The MTC6 can be field or factory equipped with a shield connector bar (see figure 2). This bar, made of treated brass, fits in the lower part of the terminal block. It ensures the continuity of the thermocouple wire shield through the terminal block or to the ground with no additional spacing.

Accessories

Description	Color	Type	Part Number	Pkg pce	Weight (1 pce) g
1 End sections 2.8 mm 0.110 in	Grey	FEM6	1SNA118368R1600	20	2.40
2 Shield connectors		CBM5	1SNA178745R1400	50	

Complete list of accessories is indicated in the terminal block datasheet. Some accessories such as jumper bars may modify the terminal block's ratings: complete information in the accessories catalogue pages.

Technical data valid for copper conductors only.



D2.5/5.C3.L spring terminal blocks

Sensors / Actuators - 5 mm 0.197 in spacing

	1.5 mm²
	16 AWG



1SNIC16209P0014

D2.5/5.C3.L

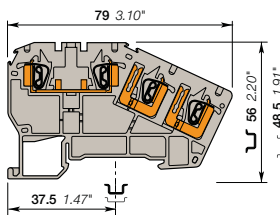

Description

- Save spacing with 3 decks terminal block, adapted for sensor/actuator in just 5 mm 0.197 in spacing,
- Easy to access thanks to the front wiring entry,
- Clamping contact pressure non dependent on the operator and automatic creeping compensation.

Ordering details

Description	Color	Type	Part Number	Pkg pce	Weight (1 pce) g
Sensor 3 wires	Grey <input type="checkbox"/>	D2.5/5.C3.L	1SNA290350R2100	50	11.00

Main technical data

		IEC	UL	CSA	Mounting instructions	
1 conductor per clamp	Rigid: Solid/Stranded	0.14-1.5 mm ²		24-16 AWG	Rail	TH 35-7.5, TH 35-15
	Flexible without ferrule	0.14-1.5 mm ²			Wire stripping length	9.5 mm 0.37 in
	Flexible with non insulated ferrule				Tool	Flat screwdriver Ø 3.5 mm Ø 0.138 in
	Flexible with insulated ferrule	0.5-1 mm ²				
	Gauge	A1				
Rated current / Rated cross section		17.5 A / 1.5 mm ²		10 A / 16 AWG		
Rated short-time withstand current (1s)		180 A				
Rated voltage		300 V		300 V		
Impulse withstand voltage		4000 V				
Protection		IP20	NEMA 1			

The connecting capacity data for one Rigid: Solid/Stranded, or one Flexible conductor (when applicable) is a mandatory information required by IEC, UL and CSA standards (Copper conductors). All other data are provided as supplementary information only. For more details, please consult our CB, UL or CSA certificates and technical datasheet available on <http://www.TE.com>

RoHS	CSA	Gost R
------	-----	--------

Notes

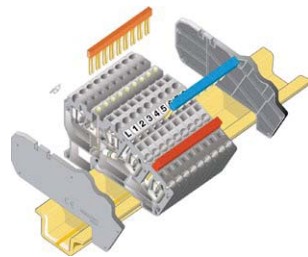

To obtain finger safety (IP20) of a terminal block assembly with comb type jumper bar, it is necessary to put one end section on each side of the terminal block assembly.

5 mm 0.197 in spacing

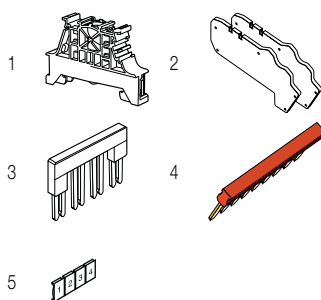

Accessories

Description	Color	Type	Part Number	Pkg pce	Weight (1 pce) g	
1 End stops	Dark grey <input type="checkbox"/>	BAZ1	1SNK900002R0000	50	5.30	
		BAM4	1SNK900001R0000	50	14.00	
2 End section kits	Grey <input type="checkbox"/>	FED5.C3.L	1SNA290358R2500	20	10.00	
3 Jumper bars	Orange <input type="checkbox"/>	2 poles	BJDL5-2	1SNA291102R2300	50	1.00
		3 poles	BJDL5-3	1SNA291103R2400	50	0.70
		4 poles	BJDL5-4	1SNA291104R2500	50	0.80
		5 poles	BJDL5-5	1SNA291105R2600	20	0.90
		10 poles	BJDL5-10	1SNA291110R2600	20	1.20
4 Lateral jumper bars 34 poles	Blue <input type="checkbox"/>	PC5.34	1SNA290365R1400	10	18.00	
	Red <input type="checkbox"/>		1SNA290366R1500	10	18.00	
	Green-yellow <input type="checkbox"/>		1SNA290367R1600	10	18.00	
5 Terminal block markers	White <input type="checkbox"/>	RC55	1SNA230000R1200	1	2.90	

Complete list of accessories is indicated in the terminal block datasheet.

Some accessories such as jumper bars may modify the terminal block's ratings: complete information in the accessories catalogue pages.

Technical data valid for copper conductors only.

D2.5/5.C3.L spring terminal blocks

Sensors / Actuators - 5 mm 0.197 in spacing



D2.5/5.C3.L

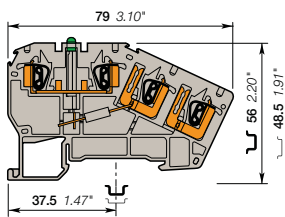

5 mm 0.197 in spacing

Description

- Save spacing with 3 decks terminal block, adapted for sensor/actuator in just 5 mm 0.197 in spacing,
- Easy to access thanks to the front wiring entry,
- Clamping contact pressure non dependent on the operator and automatic creeping compensation,
- Quickly identify the circuit status thanks to the indicator.

Ordering details

Description	Color	Type	Part Number	Pkg pce	Weight (1 pce) g
Sensor	Grey	D2.5/5.C3.L.L	1SNA290352R1700	50	11.00

Main technical data

		IEC	UL	CSA
1 conductor per clamp	Rigid: Solid/Stranded	0.14-1.5 mm ²		24-16 AWG
	Flexible without ferrule	0.14-1.5 mm ²		
	Flexible with non insulated ferrule			
	Flexible with insulated ferrule	0.5-1 mm ²		
	Gauge	A1		
Rated current / Rated cross section		17.5 A / 1.5 mm ²		10 A / 16 AWG
Rated short-time withstand current (1s)		180 A		
Rated voltage		300 V		300 V
Impulse withstand voltage		4000 V		
Protection		IP20	NEMA 1	

Mounting instructions

Rail		TH 35-7.5, TH 35-15
Wire stripping length		9.5 mm 0.37 in
Tool		Flat screwdriver Ø 3.5 mm Ø 0.138 in

The connecting capacity data for one Rigid: Solid/Stranded, or one Flexible conductor (when applicable) is a mandatory information required by IEC, UL and CSA standards (Copper conductors). All other data are provided as supplementary information only. For more details, please consult our CB, UL or CSA certificates and technical datasheet available on <http://www.TE.com>

RoHS	CSA	Gost R								
------	-----	--------	--	--	--	--	--	--	--	--

Notes

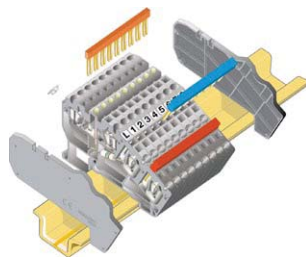

To obtain finger safety (IP20) of a terminal block assembly with comb type jumper bar, it is necessary to put one end section on each side of the terminal block assembly.

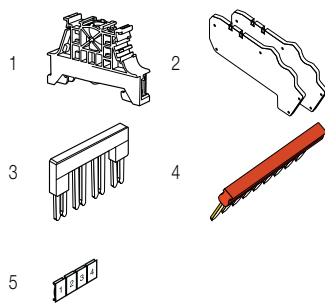

Accessories

Description	Color	Type	Part Number	Pkg pce	Weight (1 pce) g	
1 End stops	Dark grey	BAZ1	1SNK900002R0000	50	5.30	
		BAM4	1SNK900001R0000	50	14.00	
2 End section kits	Grey	FED5.C3.L	1SNA290358R2500	20	10.00	
3 Jumper bars	Orange	2 poles	1SNA291102R2300	50	1.00	
		3 poles	BJDL5-3	1SNA291103R2400	50	0.70
		4 poles	BJDL5-4	1SNA291104R2500	50	0.80
		5 poles	BJDL5-5	1SNA291105R2600	20	0.90
		10 poles	BJDL5-10	1SNA291110R2600	20	1.20
		34 poles	PC5.34	1SNA290365R1400	10	18.00
4 Lateral jumper bars	Blue		1SNA290366R1500	10	18.00	
	Red		1SNA290367R1600	10	18.00	
	Green-yellow		1SNA290367R1600	10	18.00	
5 Terminal block markers	White	RC55	1SNA230000R1200	1	2.90	

Complete list of accessories is indicated in the terminal block datasheet. Some accessories such as jumper bars may modify the terminal block's ratings: complete information in the accessories catalogue pages.

Technical data valid for copper conductors only.

D2.5/5.C4.L spring terminal blocks

Sensors / Actuators - 5 mm 0.197 in spacing

	1.5 mm²
	16 AWG



1SNK162066R014

D2.5/5.C4.L

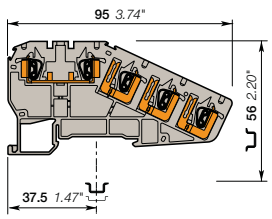

5 mm 0.197 in spacing



Description

- Save spacing with 4 decks terminal block, adapted for sensor/actuator in just 5 mm 0.197 in spacing,
- Easy to access thanks to the front wiring entry,
- Clamping contact pressure non dependent on the operator and automatic creeping compensation.

Ordering details

Description	Color	Type	Part Number	Pkg pce	Weight (1 pce) g
Sensor 4 wires sensor	Grey <input type="checkbox"/>	D2.5/5.C4.L	1SNA290354R1100	50	13.00

Main technical data

		IEC	UL	CSA	Mounting instructions	
1 conductor per clamp	Rigid: Solid/Stranded	0.14-1.5 mm ²		24-16 AWG	Rail	 TH 35-7.5, TH 35-15
	Flexible without ferrule	0.14-1.5 mm ²			Wire stripping length	 9.5 mm 0.37 in
	Flexible with non insulated ferrule				Tool	 Flat screwdriver Ø 3.5 mm Ø 0.138 in
	Flexible with insulated ferrule	0.5-1 mm ²				
	Gauge	A1				
Rated current / Rated cross section		17.5 A / 1.5 mm ²		10 A / 16 AWG		
Rated short-time withstand current (1s)		180 A				
Rated voltage		300 V		300 V		
Impulse withstand voltage		4000 V				
Protection		IP20	NEMA 1			

The connecting capacity data for one Rigid: Solid/Stranded, or one Flexible conductor (when applicable) is a mandatory information required by IEC, UL and CSA standards (Copper conductors). All other data are provided as supplementary information only. For more details, please consult our CB, UL or CSA certificates and technical datasheet available on <http://www.TE.com>

 RoHS	 CSA	 Gost R
--	---	--

Notes

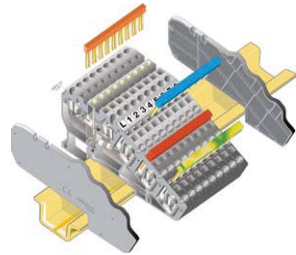

To obtain finger safety (IP20) of a terminal block assembly with comb type jumper bar, it is necessary to put one end section on each side of the terminal block assembly.

Accessories

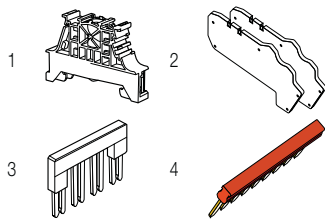

Description	Color	Type	Part Number	Pkg pce	Weight (1 pce) g	
1 End stops	Dark grey <input type="checkbox"/>	BAZ1	1SNK900002R0000	50	5.30	
		BAM4	1SNK900001R0000	50	14.00	
2 End section kits	Grey <input type="checkbox"/>	FED5.C4.L	1SNA290360R2300	20	10.00	
3 Jumper bars	Orange <input type="checkbox"/>	2 poles	BJDL5-2	1SNA291102R2300	50	1.00
		3 poles	BJDL5-3	1SNA291103R2400	50	0.70
		4 poles	BJDL5-4	1SNA291104R2500	50	0.80
		5 poles	BJDL5-5	1SNA291105R2600	20	0.90
		10 poles	BJDL5-10	1SNA291110R2600	20	1.20
4 Lateral jumper bars 34 poles	Blue <input type="checkbox"/>	PC5.34	1SNA290365R1400	10	18.00	
	Red <input type="checkbox"/>		1SNA290366R1500	10	18.00	
	Green-yellow <input type="checkbox"/>		1SNA290367R1600	10	18.00	
5 Terminal block markers	White <input type="checkbox"/>	RC55	1SNA230000R1200	1	2.90	

Complete list of accessories is indicated in the terminal block datasheet. Some accessories such as jumper bars may modify the terminal block's ratings: complete information in the accessories catalogue pages.

Technical data valid for copper conductors only.

D2.5/5.C4.L spring terminal blocks

Sensors / Actuators - 5 mm 0.197 in spacing



D2.5/5.C4.L

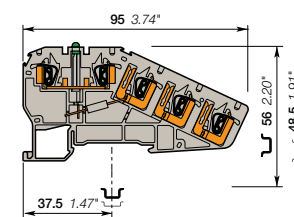

5 mm 0.197 in spacing

Description

- Save spacing with 4 decks terminal block, adapted for sensor/actuator in just 5 mm 0.197 in spacing,
- Easy to access thanks to the front wiring entry,
- Clamping contact pressure non dependent on the operator and automatic creeping compensation,
- Quickly identify the circuit status thanks to the indicator.

Ordering details

Description	Color	Type	Part Number	Pkg pce	Weight (1 pce) g
Sensor 4 wires with bidirectional green LED 24 V DC	Grey	D2.5/5.C4.L.L	1SNA290356R1300	50	13.00

Main technical data

		IEC	UL	CSA
1 conductor per clamp	Rigid: Solid/Stranded	0.14-1.5 mm²		24-16 AWG
	Flexible without ferrule	0.14-1.5 mm²		
	Flexible with non insulated ferrule			
	Flexible with insulated ferrule	0.5-1 mm²		
	Gauge	A1		
Rated current / Rated cross section		17.5 A / 1.5 mm²		10 A / 16 AWG
Rated short-time withstand current (1s)		180 A		
Rated voltage		300 V		300 V
Impulse withstand voltage		4000 V		
Protection		IP20	NEMA 1	

Mounting instructions

Rail		TH 35-7.5, TH 35-15
Wire stripping length		9.5 mm 0.37 in
Tool		Flat screwdriver Ø 3.5 mm Ø 0.138 in

The connecting capacity data for one Rigid: Solid/Stranded, or one Flexible conductor (when applicable) is a mandatory information required by IEC, UL and CSA standards (Copper conductors). All other data are provided as supplementary information only. For more details, please consult our CB, UL or CSA certificates and technical datasheet available on <http://www.TE.com>

RoHS	CSA	Gost R							
------	-----	--------	--	--	--	--	--	--	--

Notes

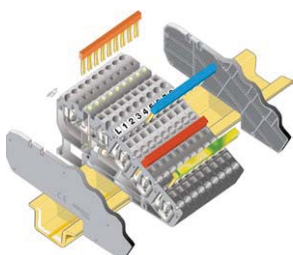

To obtain finger safety (IP20) of a terminal block assembly with comb type jumper bar, it is necessary to put one end section on each side of the terminal block assembly.

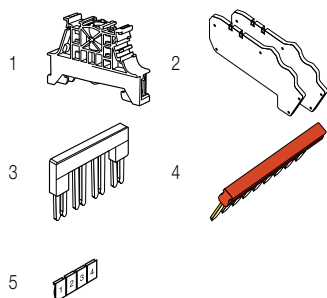

Accessories

Description	Color	Type	Part Number	Pkg pce	Weight (1 pce) g	
1 End stops	Dark grey	BAZ1	1SNK900002R0000	50	5.30	
		BAM4	1SNK900001R0000	50	14.00	
2 End section kits	Grey	FED5.C4.L	1SNA290360R2300	20	10.00	
3 Jumper bars	Orange	2 poles 24 A	BJDL5-2	1SNA291102R2300	50	1.00
		3 poles	BJDL5-3	1SNA291103R2400	50	0.70
		4 poles	BJDL5-4	1SNA291104R2500	50	0.80
		5 poles	BJDL5-5	1SNA291105R2600	20	0.90
		10 poles	BJDL5-10	1SNA291110R2600	20	1.20
4 Lateral jumper bars 34 poles	Blue	PC5.34	1SNA290365R1400	10	18.00	
	Red		1SNA290366R1500	10	18.00	
	Green-yellow		1SNA290367R1600	10	18.00	
5 Terminal block markers Blank card	White	RC55	1SNA230000R1200	1	2.90	

Complete list of accessories is indicated in the terminal block datasheet.

Some accessories such as jumper bars may modify the terminal block's ratings: complete information in the accessories catalogue pages.

Technical data valid for copper conductors only.

D1/5.C3.ADO IDC terminal blocks

Sensors / Actuators ADO-ADO - 5 mm 0.197 in spacing



D1/5.C3.ADO

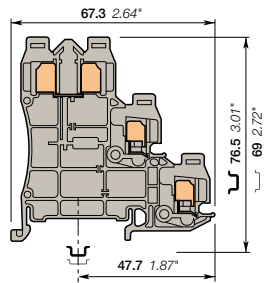

5 mm 0.197 in spacing

Description

- Save spacing with 3 decks terminal block, adapted for sensor/actuator in just 5 mm 0.197 in spacing,
- With the TE Connectivity ADO System®, experience the fastest and most reliable connection on the market,
- Designed for control applications exposed to severe constrains (vibrations, shocks, corrosion etc.),
- Up to 2 wires on the upper deck.

Ordering details

Description	Color	Type	Part Number	Pkg pce	Weight (1 pce) g
Sensor For 3 wire sensor	Grey	D1/5.C3.ADO	1SNA399689R1300	50	9.00

Main technical data

		IEC	UL	CSA	Mounting instructions	
ADO	Rigid: Solid/Stranded Flexible without ferrule	0.2-1 mm² 0.22-1 mm²		24-20 AWG	Rail	TH 35-7.5, TH 35-15
Screw clamp	Rigid: Solid/Stranded Flexible without ferrule Flexible with insulated ferrule Gauge				Wire stripping length	
Rated current / Rated cross section		13.5 A / 1 mm²		12 A / 20 AWG	Tool	
Rated short-time withstand current (1s)		120 A			Torque	
Rated voltage		250 V		600 V		
Impulse withstand voltage		8000 V				
Protection		IP20	NEMA 1			

The connecting capacity data for one Rigid: Solid/Stranded, or one Flexible conductor (when applicable) is a mandatory information required by IEC, UL and CSA standards (Copper conductors). All other data are provided as supplementary information only. For more details, please consult our CB, UL or CSA certificates and technical datasheet available on <http://www.TE.com>



Notes

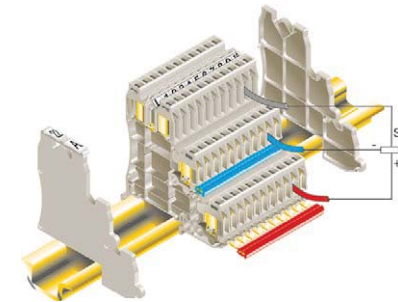

Accessories

Description	Color	Type	Part Number	Pkg pce	Weight (1 pce) g
1 End stops	Dark grey	BAM4	1SNK900001R0000	50	14.00
		BAZ1	1SNK900002R0000	50	5.30
2 End section kits	Grey	FED5.C3.ADO	1SNA399678R2700	20	10.00
3 Lateral jumper bars 10 poles	Red	PC52.10	1SNA399683R0500	10	5.00
	Blue		1SNA399684R0600	10	5.00
	Green-yellow		1SNA399685R0700	10	5.00
	Red	PC52.66	1SNA399707R1500	5	30.00
	Blue		1SNA399708R2600	5	30.00
	Green-yellow		1SNA399709R2700	5	30.00
4 Tools		Semi automatic tool	OUPAD	1	205.00
		Hand tool	OUMAD	1	29.00
5 Terminal block markers	White	Blank card	RC55	1	2.90

Complete list of accessories is indicated in the terminal block datasheet.

Some accessories such as jumper bars may modify the terminal block's ratings: complete information in the accessories catalogue pages.

Technical data valid for copper conductors only.

D1/5.C3.ADO IDC terminal blocks

Sensors / Actuators ADO-ADO - 5 mm 0.197 in spacing



D1/5.C3.ADO

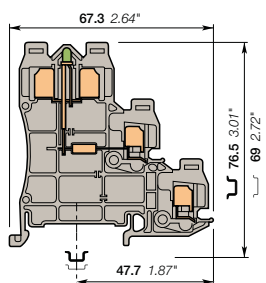

5 mm 0.197 in spacing





Description

- Save spacing with 3 decks terminal block, adapted for sensor/actuator in just 5 mm 0.197 in spacing,
- With the TE Connectivity ADO System®, experience the fastest and most reliable connection on the market,
- Designed for control applications exposed to severe constrains (vibrations, shocks, corrosion etc.),
- Up to 2 wires on the upper deck.



Ordering details

Description	Color	Type	Part Number	Pkg pce	Weight (1 pce) g
Sensor For 3 wire sensor with green bidirectional LED 24 VDC	Grey <input type="checkbox"/>	D1/5.C3.ADO.L	1SNA399690R1000	50	10.00

Main technical data

	IEC	UL	CSA	Mounting instructions
ADO	Rigid: Solid/Stranded Flexible without ferrule Flexible with insulated ferrule	0.2-1 mm² 0.22-1 mm²	24-20 AWG	Rail  Wire stripping length 
Screw clamp	Rigid: Solid/Stranded Flexible without ferrule Flexible with insulated ferrule			Tool 
Rated current / Rated cross section	13.5 A / 1 mm²		12 A / 20 AWG	Torque 
Rated short-time withstand current (1s)	120 A			
Rated voltage	250 V		600 V	
Impulse withstand voltage	8000 V			
Protection	IP20	NEMA 1		

The connecting capacity data for one Rigid: Solid/Stranded, or one Flexible conductor (when applicable) is a mandatory information required by IEC, UL and CSA standards (Copper conductors). All other data are provided as supplementary information only. For more details, please consult our CB, UL or CSA certificates and technical datasheet available on <http://www.TE.com>

 RoHS	 cCSAus	 Gost R
--	--	--

Notes

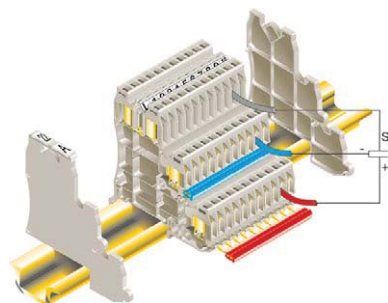

Accessories

Description	Color	Type	Part Number	Pkg pce	Weight (1 pce) g
1 End stops	Dark grey <input type="checkbox"/>	BAM4	1SNK900001R0000	50	14.00
		BAZ1	1SNK900002R0000	50	5.30
2 End section kits	Grey <input type="checkbox"/>	FED5.C3.ADO	1SNA399678R2700	20	10.00
3 Lateral jumper bars 10 poles	Red <input type="checkbox"/>	PC52.10	1SNA399683R0500	10	5.00
	Blue <input type="checkbox"/>		1SNA399684R0600	10	5.00
	Green-yellow <input type="checkbox"/>		1SNA399685R0700	10	5.00
	Red <input type="checkbox"/>	PC52.66	1SNA399707R1500	5	30.00
	Blue <input type="checkbox"/>		1SNA399708R2600	5	30.00
	Green-yellow <input type="checkbox"/>		1SNA399709R2700	5	30.00
4 Tools		Semi automatic tool	OUPAD	1	205.00
		Hand tool	OUMAD	1	29.00
5 Terminal block markers	White <input type="checkbox"/>	Blank card	RC55	1	2.90

Complete list of accessories is indicated in the terminal block datasheet.

Some accessories such as jumper bars may modify the terminal block's ratings: complete information in the accessories catalogue pages.

Technical data valid for copper conductors only.

D1/5.C4.ADO IDC terminal blocks

Sensors / Actuators ADO-ADO - 5 mm 0.197 in spacing



Description

- Save spacing with 4 decks terminal block, adapted for sensor/actuator in just 5 mm 0.197 in spacing,
- With the TE Connectivity ADO System®, experience the fastest and most reliable connection on the market,
- Designed for control applications exposed to severe constrains (vibrations, shocks, corrosion etc.),
- Up to 2 wires on the upper deck.

Ordering details

Description	Color	Type	Part Number	Pkg pce	Weight (1 pce) g
Sensor For 4 wire sensor	Grey	D1/5.C4.ADO	1SNA399692R0600	50	

Main technical data

		IEC	UL	CSA	Mounting instructions	
ADO	Rigid: Solid/Stranded Flexible without ferrule	0.2-1 mm² 0.22-1 mm²		24-20 AWG	Rail	TH 35-7.5, TH 35-15
Screw clamp	Rigid: Solid/Stranded Flexible without ferrule Flexible with insulated ferrule Gauge				Wire stripping length	
Rated current / Rated cross section		13.5 A / 1 mm²		12 A / 20 AWG	Tool	
Rated short-time withstand current (1s)		120 A			Torque	
Rated voltage		250 V		600 V		
Impulse withstand voltage		8000 V				
Protection		IP20	NEMA 1			

The connecting capacity data for one Rigid: Solid/Stranded, or one Flexible conductor (when applicable) is a mandatory information required by IEC, UL and CSA standards (Copper conductors). All other data are provided as supplementary information only. For more details, please consult our CB, UL or CSA certificates and technical datasheet available on <http://www.TE.com>

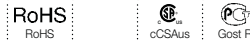

Notes

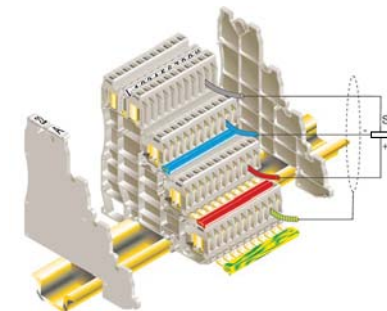

D1/5.C4.ADO

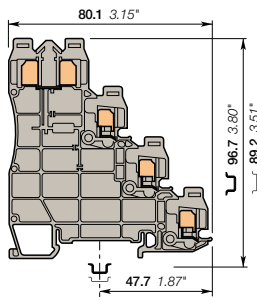

5 mm 0.197 in spacing

Accessories

Description	Color	Type	Part Number	Pkg pce	Weight (1 pce) g
1 End stops 10 mm 0.394 in	Dark grey	BAZH1	1SNK900102R0000	20	24.00
2 End section kits	Grey	FED5.C4.ADO	1SNA399679R2000	10	10.00
3 Lateral jumper bars 10 poles	Red	PC52.10	1SNA399683R0500	10	5.00
	Blue		1SNA399684R0600	10	5.00
	Green-yellow		1SNA399685R0700	10	5.00
	Red	PC52.66	1SNA399707R1500	5	30.00
	Blue		1SNA399708R2600	5	30.00
4 Tools Semi automatic tool	Green-yellow		1SNA399709R2700	5	30.00
		OUPAD	1SNA178944R0400	1	205.00
		OUMAD	1SNA179466R0600	1	29.00
5 Terminal block markers Blank card	White	RC55	1SNA230000R1200	1	2.90

Complete list of accessories is indicated in the terminal block datasheet.

Some accessories such as jumper bars may modify the terminal block's ratings: complete information in the accessories catalogue pages.

Technical data valid for copper conductors only.

D1/5.C4.ADO IDC terminal blocks

Sensors / Actuators ADO-ADO - 5 mm 0.197 in spacing



D1/5.C4.ADO

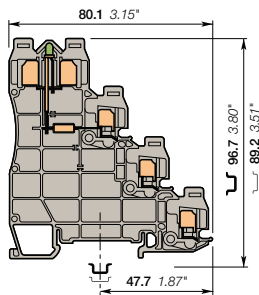

5 mm 0.197 in spacing

Description

- Save spacing with 4 decks terminal block, adapted for sensor/actuator in just 5 mm 0.197 in spacing,
- With the TE Connectivity ADO System®, experience the fastest and most reliable connection on the market,
- Designed for control applications exposed to severe constrains (vibrations, shocks, corrosion etc.),
- Up to 2 wires on the upper deck.

Ordering details

Description	Color	Type	Part Number	Pkg pce	Weight (1 pce) g
Sensor For 4 wire sensor with green bidirectional LED 24 VDC	Grey <input type="checkbox"/>	D1/5.C4.ADO.L	1SNA399693R0700	50	

Main technical data

	IEC	UL	CSA	Mounting instructions
ADO	Rigid: Solid/Stranded Flexible without ferrule 0.2-1 mm² 0.22-1 mm²			Rail TH 35-7.5, TH 35-15 Wire stripping length
Screw clamp	Rigid: Solid/Stranded Flexible without ferrule Flexible with insulated ferrule Gauge			Tool
Rated current / Rated cross section	13.5 A / 1 mm²			Torque
Rated short-time withstand current (1s)	120 A			
Rated voltage	250 V			
Impulse withstand voltage	8000 V			
Protection	IP20	NEMA 1		

The connecting capacity data for one Rigid: Solid/Stranded, or one Flexible conductor (when applicable) is a mandatory information required by IEC, UL and CSA standards (Copper conductors). All other data are provided as supplementary information only. For more details, please consult our CB, UL or CSA certificates and technical datasheet available on <http://www.TE.com>

RoHS	RoHS	PCB	Gost R
------	------	-----	--------

Notes

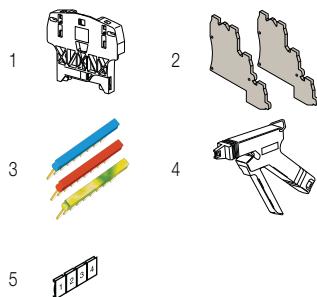
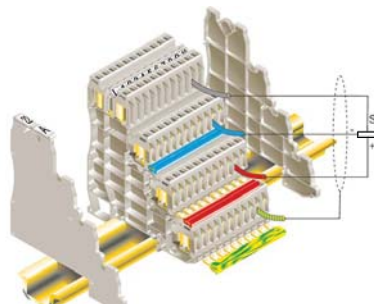

Accessories

Description	Color	Type	Part Number	Pkg pce	Weight (1 pce) g	
1 End stops 10 mm 0.394 in	Dark grey <input type="checkbox"/>	BAZH1	1SNK900102R0000	20	24.00	
2 End section kits	Grey <input type="checkbox"/>	FED5.C4.ADO	1SNA399679R2000	10	10.00	
3 Lateral jumper bars 10 poles 66 poles	Red <input type="checkbox"/>	PC52.10	1SNA399683R0500	10	5.00	
	Blue <input type="checkbox"/>		1SNA399684R0600	10	5.00	
	Green-yellow <input type="checkbox"/>		1SNA399685R0700	10	5.00	
	Red <input type="checkbox"/>	PC52.66	1SNA399707R1500	5	30.00	
	Blue <input type="checkbox"/>		1SNA399708R2600	5	30.00	
4 Tools	Green-yellow <input type="checkbox"/>		1SNA399709R2700	5	30.00	
		Semi automatic tool	OUPAD	1SNA178944R0400	1	205.00
5 Terminal block markers Blank card		Hand tool	OUMAD	1SNA179466R0600	1	29.00
	White <input type="checkbox"/>		RC55	1SNA230000R1200	1	2.90

Complete list of accessories is indicated in the terminal block datasheet.

Some accessories such as jumper bars may modify the terminal block's ratings: complete information in the accessories catalogue pages.

Technical data valid for copper conductors only.

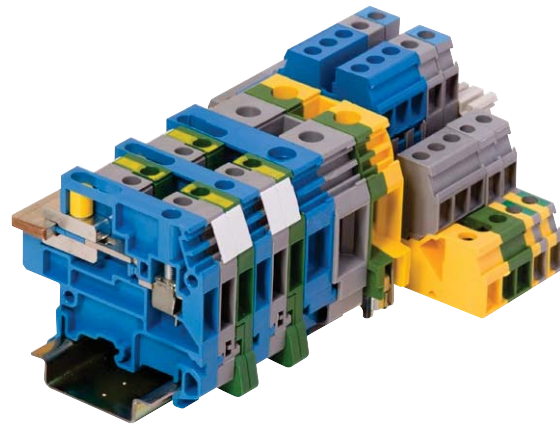

1SINC160103S0201

Dedicated applications terminal blocks

Installation terminal blocks

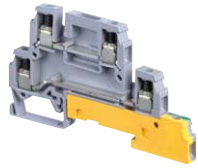
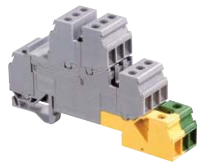
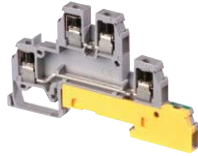
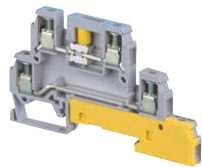
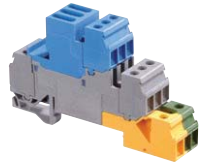
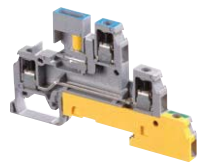

Technologies presentation	208
Overview	210

Screw clamp technology

Multi-level terminal blocks compatible with busbar

4 mm ² / 12 AWG	D4/6.NTLP	Disconnect neutral + feed-through + ground	213
	D4/6.NLP	Neutral + feed-through + ground	214
	D4/6.LLP	Feed-through + ground	215
	D4/6.LL	Feed-through	216
	D4/6.LNTP1 &		
	D4/6.LNTP3	Disconnect neutral + feed-through + ground	217
	D4/6.LNTP2 &		
	D4/6.LNTP8	Neutral + feed-through + ground	219
	D4/6.LNTP4 &		
	D4/6.LNTP7	Feed-through + ground	221
	D4/6.LNTP6	Feed-through	223

Multi-level terminal blocks

4 mm ² / 12 AWG	D4/6.A.NTLP	Disconnect neutral + feed-through + ground	224
	D4/6.A.LLP	Feed-through + ground	225

Compatible with busbar

2.5 mm ²	MA2.5/5.NT	Neutral disconnect	226
4 mm ²	M4/6.NT	Neutral disconnect	227
6 mm ²	M6/8.NT	Neutral disconnect	228
10 mm ²	M10/10.NT	Neutral disconnect	229
16 mm ²	M16/12.NT	Neutral disconnect	230
35 mm ²	M35/16.NT	Neutral disconnect	231

Spring clamp technology

Multi-level terminal blocks compatible with busbar

2.5 mm ² / 12 AWG	D2.5/5.NTLP.L	Disconnect neutral + feed-through + ground	232
	D2.5/5.NLP.L	Neutral + feed-through + ground	233
	D2.5/5.NL.L	Neutral + feed-through	234
	D2.5/5.LLP.L	Feed-through + ground	235
	D2.5/5.LL.L	Feed-through	236

Dedicated applications terminal blocks

Installation terminal blocks

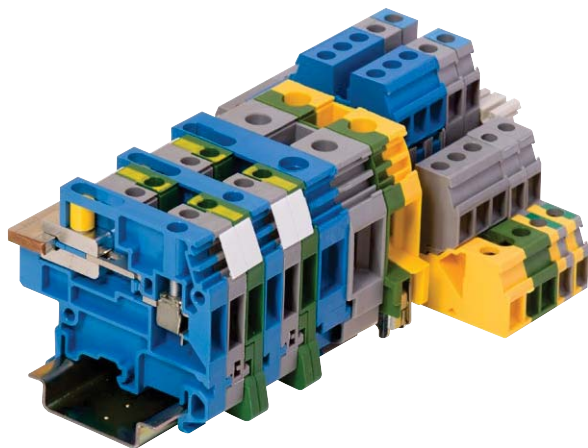

The preferred choice for building industry

The installation terminal blocks are largely used in distribution cabinets of public buildings and meet wiring and connection requirements of installations designed in accordance with DIN VDE 0100 or DIN VDE 0108.

They allow:

- Compact signal distribution thanks to multi-level terminal locks
- Insulation test without disconnecting the neutral conductor thanks to neutral disconnect function on TNS or TNC-S networks.

Select from our various choice of functions and technologies

Installation terminal blocks

Our product family offer multi-circuit configuration to ease the distribution of single phase or 3 phase circuits. Installation terminal blocks are proposed in screw clamp technology.

Various configurations allow distribution of feed-through, neutral, neutral disconnect and ground circuits in a compact format.

Select from our single type terminal blocks or prefer multi-circuit compact and closed solution combining up to 9 circuits on one single terminal block.

Neutral bar is aligned with standard single deck terminal blocks and ensures full compatibility with standard feed-through, neutral disconnect, or ground terminal blocks.

Neutral disconnect terminal blocks

Neutral disconnect function is mandatory on TNS or TN-C-S networks used in public buildings and installation complying with VDE 0108.

Standard specifies:

"The distribution must be designed so that it is possible to measure the insulation resistance of all conductors to ground for each individual outgoing circuit with conductor cross sections up to 10 mm². This measurement must be performed without disconnecting the neutral conductor. e.g. through the installation of neutral conductor disconnect terminal blocks."

Our terminals allow simple connection or disconnection of neutral bar thanks to a sliding link.

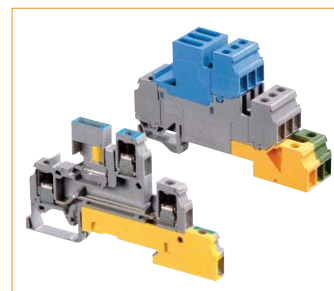

Multi-level screw clamp terminal blocks



Multi-level spring clamp terminal blocks

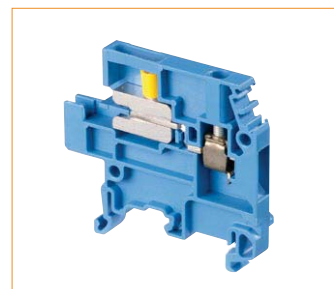

Neutral disconnect: screw clamp terminal blocks

Dedicated applications terminal blocks

Installation terminal blocks

3 phase distribution example with installation screw clamp terminal blocks

D4/6.NTLP allows single phase distribution and neutral disconnect

D4/6.LL complement for 3 phase configuration

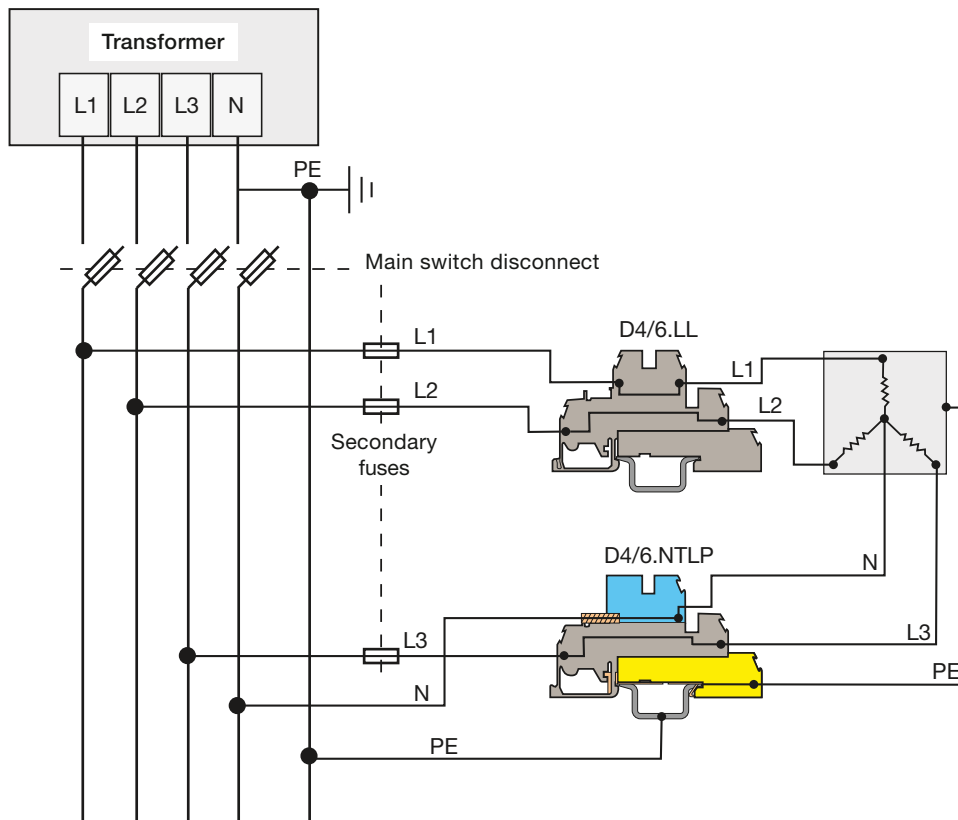

Dedicated applications terminal blocks

Installation terminal blocks

Screw clamp technology, multi-level terminal blocks compatible with busbar

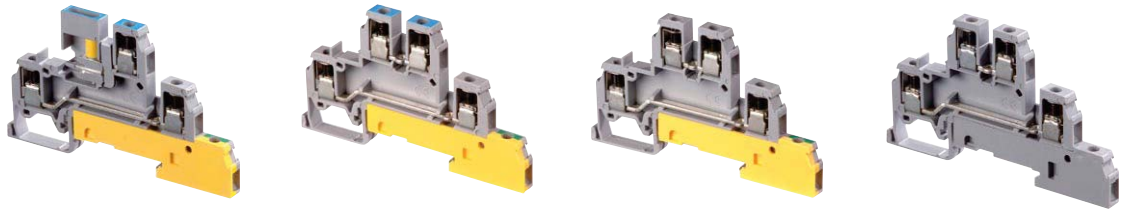

Section		NTLP	NLP	LLP	LL
IEC	UL/CSA				
4 mm ²	12 AWG	D4/6.NTLP 6 mm 0.236 in	D4/6.NLP 6 mm 0.236 in	D4/6.LLP 6 mm 0.236 in	D4/6.LL 6 mm 0.236 in

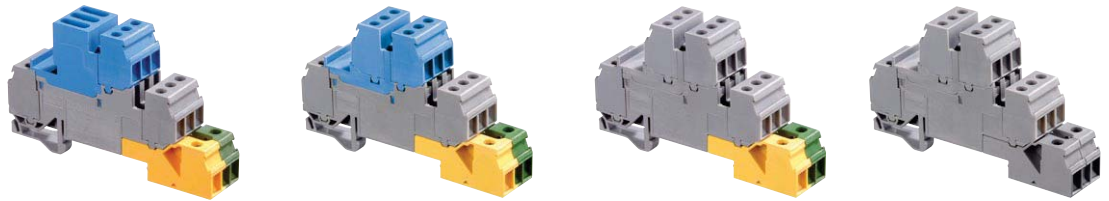

Section		NTLP		NLP		LLP		LL
IEC	UL/CSA							
4 mm ²	12 AWG	D4/6.LNTP1 6 mm 0.236 in	D4/6.LNTP3 6 mm 0.236 in	D4/6.LNTP2 6 mm 0.236 in	D4/6.LNTP8 6 mm 0.236 in	D4/6.LNTP4 6 mm 0.236 in	D4/6.LNTP7 6 mm 0.236 in	D4/6.LNTP6 6 mm 0.236 in

Screw clamp technology, multi-level terminal blocks



Section		NTLP	NLP	LLP	LL
IEC	UL/CSA				
4 mm ²	12 AWG	D4/6.A.NTLP 6 mm 0.236 in		D4/6.A.LLP 6 mm 0.236 in	

1SNC160102S0201



Screw clamp technology, compatible with busbar



Neutral disconnect

Feed-through

Ground

Section				
IEC	UL/CSA			
2.5 mm ²		MA2.5/5.NT 5 mm 0.197 in	MA2.5/5 5 mm 0.197 in	MA2.5/5.P 5 mm 0.197 in
4 mm ²	12 AWG	M4/6.NT 6 mm 0.236 in	M4/6 6 mm 0.236 in	M4/6.P 6 mm 0.236 in
6 mm ²	8 AWG	M6/8.NT 8 mm 0.315 in	M6/8 8 mm 0.315 in	M6/8.P 8 mm 0.315 in
10 mm ²	6 AWG	M10/10.NT 10 mm 0.394 in	M10/10 10 mm 0.394 in	M10/10.P 10 mm 0.394 in
16 mm ²		M16/12.NT 12 mm 0.472 in	M16/12 12 mm 0.472 in	M16/12.P 12 mm 0.472 in
35 mm ²	0 AWG	M35/16.NT 17 mm 0.669 in	M35/16 16 mm 0.630 in	M35/16.P 16 mm 0.630 in

Dedicated applications terminal blocks

Installation terminal blocks

Spring clamp technology, multi-level terminal blocks compatible with busbar



Section		NTLP	NLP	NL	LLP	LL
IEC	UL/CSA					
2.5 mm ²	12 AWG	D2.5/5.NTLP 5 mm 0.197 in	D2.5/5.NLP 5 mm 0.197 in	D2.5/5.NL.L 5 mm 0.197 in	D2.5/5.LLP 5 mm 0.197 in	D2.5/5.LL.L 5 mm 0.197 in

D4/6.NTLP screw clamp terminal blocks

Installation - 6 mm 0.236 in spacing

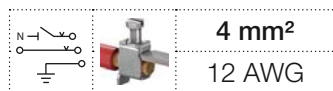

4 mm²
12 AWG

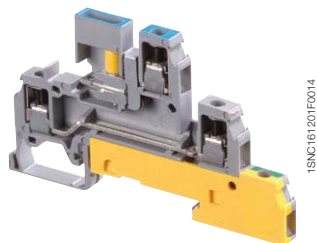

D4/6.NTLP

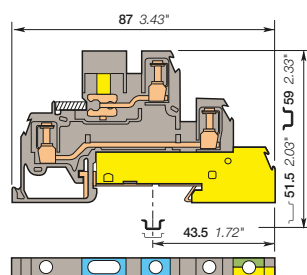

6 mm 0.236 in spacing

Description

- According to DIN 43880 standards (dimension above the rail 35 x 7.5 ≤ 44 mm),
- Compatible with busbar.

Ordering details

Description	Color	Type	Part Number	Pkg pce	Weight (1 pce) g
Installation Disconnect neutral + feed-through + ground	Grey, blue, Green-yellow	D4/6.NTLP	1SNA110439R2200	20	20.00

Main technical data

		IEC	UL	CSA	Mounting instructions	
1 conductor per clamp	Rigid: Solid/Stranded	0.2-4 mm ²	18-12 AWG		Rail	G32, TH 35-7.5, TH 35-15
	Flexible without ferrule	0.2-4 mm ²			Wire stripping length	9.5 mm 0.37 in
	Flexible with insulated ferrule				Screw clamp Tool	Flat screwdriver Ø 4 mm Ø 0.157 in
	Gauge	A4			Torque	0.4 - 0.8 N.m 3.5 - 7 lb.in
Rated current / Rated cross section		30 A / 4 mm ²	20 A / 12 AWG		Disconnect device Tool	Flat screwdriver Ø 4 mm Ø 0.157 in
Rated short-time withstand current (1s)		480 A			Torque	0.4 - 0.6 N.m 3.5 - 5.3 lb.in
Rated voltage		320 V	300 V			
Impulse withstand voltage		4000 V				
Protection		IP20	NEMA 1			

The connecting capacity data for one Rigid: Solid/Stranded, or one Flexible conductor (when applicable) is a mandatory information required by IEC, UL and CSA standards (Copper conductors). All other data are provided as supplementary information only. For more details, please consult our CB, UL or CSA certificates and technical datasheet available on <http://www.TE.com>

CE	RoHS	UL	CSA	PCB	Gost R						
CE	RoHS	UL	CSA	PCB	Gost R						

Accessories

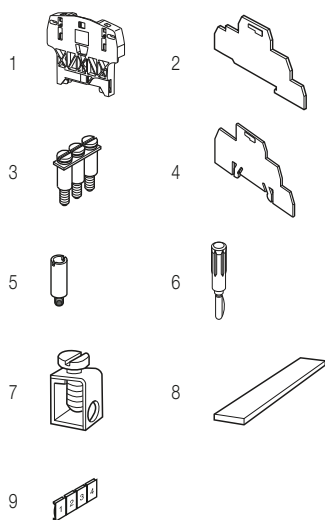

Description	Color	Type	Part Number	Pkg pce	Weight (1 pce) g
1 End stops 10 mm 0.394 in	Dark grey	BAZH1	1SNK900102R0000	20	24.00
2 End sections 1 mm 0.039 in	Grey	FED6	1SNA116964R1200	20	3.00
3 Jumper bars 2 poles 32 A		BJM62	1SNA173217R2600	10	2.00
			1SNA173218R0700	10	3.00
			1SNA173219R0000	10	4.00
			1SNA173221R2200	10	5.00
			1SNA173226R2700	10	10.00
4 Circuit separators 1.5 mm 0.059 in	Grey	SCFD	1SNA114117R0700	10	10.00
5 Test sockets DIA 2 mm 0.079 in		AL2	1SNA167319R0600	50	
6 Test plugs DIA 2 mm 0.079 in	Black	FC2	1SNA007865R2600	100	
7 Clamps 0.5-35 mm ²		SFB1	1SNA163860R0500	50	12.00
		SFB2	1SNA168956R0600	50	11.00
8 Busbars Busbars		BO3	1SNA164406R2400	1	
9 Terminal block markers Blank card	White	RC65	1SNA232000R0000	1	3.60

Complete list of accessories is indicated in the terminal block datasheet.
Some accessories such as jumper bars may modify the terminal block's ratings: complete information in the accessories catalogue pages.

Technical data valid for copper conductors only.

D4/6.NLP screw clamp terminal blocks

Installation - 6 mm 0.236 in spacing

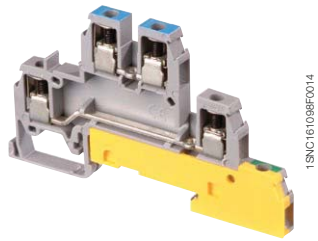
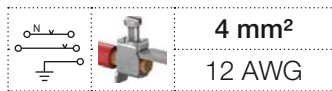

D4/6.NLP

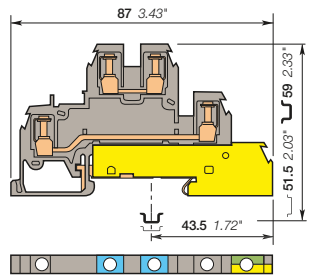

6 mm 0.236 in spacing

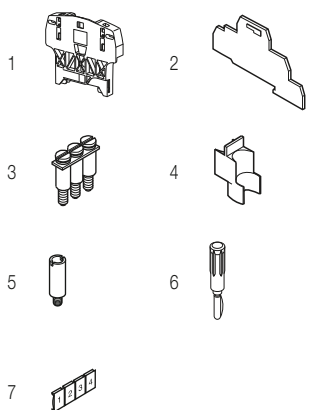

Description

- According to DIN 43880 standards (dimension above the rail 35 x 7.5 ≤ 44 mm),
- Compatible with busbar.

Ordering details

Description	Color	Type	Part Number	Pkg pce	Weight (1 pce) g
Installation Neutral + feed-through + ground	Grey, blue, Green-yellow	D4/6.NLP	1SNA110440R0700	20	20.00

Main technical data

		IEC	UL	CSA
1 conductor per clamp	Rigid: Solid/Stranded	0.2-4 mm ²	18-12 AWG	
	Flexible without ferrule	0.2-4 mm ²		
	Flexible with insulated ferrule			
	Gauge	A4		
Rated current / Rated cross section		30 A / 4 mm ²	20 A / 12 AWG	
Rated short-time withstand current (1s)		480 A		
Rated voltage		400 V	300 V	
Impulse withstand voltage		6000 V		
Protection		IP20	NEMA 1	

Mounting instructions

Rail		G32, TH 35-7.5, TH 35-15
Wire stripping length		9.5 mm 0.37 in
Tool		Flat screwdriver Ø 4 mm Ø 0.157 in
Torque		0.4 - 0.8 N.m 3.5 - 7 lb.in

The connecting capacity data for one Rigid: Solid/Stranded, or one Flexible conductor (when applicable) is a mandatory information required by IEC, UL and CSA standards (Copper conductors). All other data are provided as supplementary information only. For more details, please consult our CB, UL or CSA certificates and technical datasheet available on <http://www.TE.com>

CE	RoHS	UL	CSA	Goet R
CE	RoHS	UL	CSA	Goet R

Accessories

Description	Color	Type	Part Number	Pkg pce	Weight (1 pce) g
1 End stops 10 mm 0.394 in	Dark grey	BAZH1	1SNK900102R0000	20	24.00
2 End sections 1 mm 0.039 in	Grey	FED6	1SNA116964R1200	20	3.00
3 Jumper bars 2 poles 32 A		BJM62	1SNA173217R2600	10	2.00
			1SNA173218R0700	10	3.00
			1SNA173219R0000	10	4.00
			1SNA173221R2200	10	5.00
			1SNA173226R2700	10	10.00
4 Circuit separators 0 mm 0 in	White	SCD	1SNA103189R2600	10	1.00
	Grey	SCFD	1SNA114117R0700	10	10.00
5 Test sockets DIA 2 mm 0.079 in		AL2	1SNA167319R0600	50	
6 Test plugs DIA 2 mm 0.079 in	Black	FC2	1SNA007865R2600	100	
7 Terminal block markers Blank card	White	RC65	1SNA23200R0000	1	3.60

Complete list of accessories is indicated in the terminal block datasheet.

Some accessories such as jumper bars may modify the terminal block's ratings: complete information in the accessories catalogue pages.

Technical data valid for copper conductors only.

D4/6.LLP screw clamp terminal blocks

Installation - 6 mm 0.236 in spacing

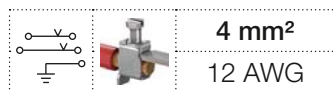

4 mm²
12 AWG

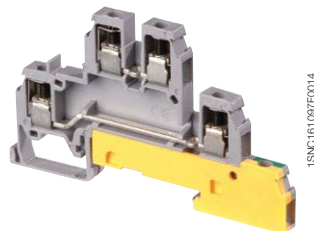

D4/6.LLP

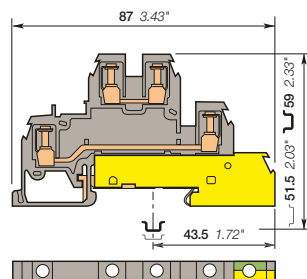

6 mm 0.236 in spacing

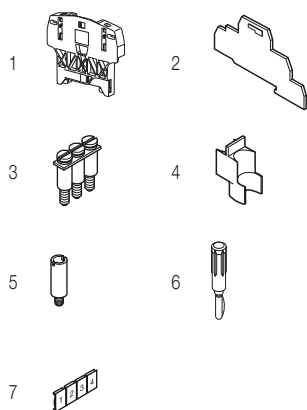

Description

- According to DIN 43880 standards (dimension above the rail $35 \times 7.5 \leq 44$ mm),
- Compatible with busbar.

Ordering details

Description	Color	Type	Part Number	Pkg pce	Weight (1 pce) g
Installation 2 feed-through + ground	Grey, Green-yellow	D4/6.LLP	1SNA110441R2400	20	20.00

Main technical data

		IEC	UL	CSA
1 conductor per clamp	Rigid: Solid/Stranded	0.2-4 mm ²	18-12 AWG	
	Flexible without ferrule	0.2-4 mm ²		
	Flexible with insulated ferrule			
Gauge		A4		
Rated current / Rated cross section		30 A / 4 mm ²	20 A / 12 AWG	
Rated short-time withstand current (1s)		480 A		
Rated voltage		400 V	300 V	
Impulse withstand voltage		6000 V		
Protection		IP20	NEMA 1	

Mounting instructions

Rail		G32, TH 35-7.5, TH 35-15
Wire stripping length		9.5 mm 0.37 in
Tool		Flat screwdriver Ø 4 mm Ø 0.157 in
Torque		0.4 - 0.8 N.m 3.5 - 7 lb.in

The connecting capacity data for one Rigid: Solid/Stranded, or one Flexible conductor (when applicable) is a mandatory information required by IEC, UL and CSA standards (Copper conductors). All other data are provided as supplementary information only. For more details, please consult our CB, UL or CSA certificates and technical datasheet available on <http://www.TE.com>

CE	RoHS	UL US	PC	Gost R						
CE	RoHS	UL US	PC	Gost R						

Accessories

Description	Color	Type	Part Number	Pkg pce	Weight (1 pce) g
1 End stops 10 mm 0.394 in	Dark grey	BAZH1	1SNK900102R0000	20	24.00
2 End sections 1 mm 0.039 in	Grey	FED6	1SNA116964R1200	20	3.00
3 Jumper bars 2 poles 32 A		BJM62	1SNA173217R2600	10	2.00
			1SNA173218R0700	10	3.00
			1SNA173219R0000	10	4.00
			1SNA173221R2200	10	5.00
			1SNA173226R2700	10	10.00
4 Circuit separators 0 mm 0 in	White	SCD	1SNA103189R2600	10	1.00
	Grey	SCFD	1SNA114117R0700	10	10.00
5 Test sockets DIA 2 mm 0.079 in		AL2	1SNA167319R0600	50	
6 Test plugs DIA 2 mm 0.079 in	Black	FC2	1SNA007865R2600	100	
7 Terminal block markers Blank card	White	RC65	1SNA232000R0000	1	3.60

Complete list of accessories is indicated in the terminal block datasheet. Some accessories such as jumper bars may modify the terminal block's ratings: complete information in the accessories catalogue pages.

Technical data valid for copper conductors only.

D4/6.LL screw clamp terminal blocks

Installation - 6 mm 0.236 in spacing

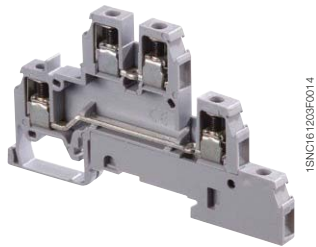
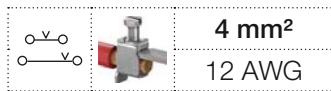

D4/6.LL

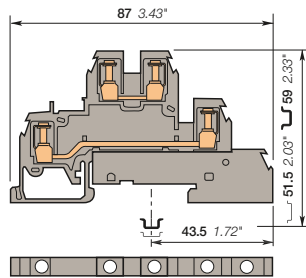

6 mm 0.236 in spacing

Description

- According to DIN 43880 standards (dimension above the rail $35 \times 7.5 \leq 44$ mm),
- Compatible with busbar.

Ordering details

Description	Color	Type	Part Number	Pkg pce	Weight (1 pce) g
Installation 2 feed-through	Grey <input type="checkbox"/>	D4/6.LL	1SNA110442R2500	20	20.00

Main technical data

		IEC	UL	CSA	Mounting instructions	
1 conductor per clamp	Rigid: Solid/Stranded	0.2-4 mm ²	18-12 AWG		Rail	G32, TH 35-7.5, TH 35-15
	Flexible without ferrule	0.2-4 mm ²			Wire stripping length	9.5 mm 0.37 in
	Flexible with insulated ferrule				Tool	Flat screwdriver Ø 4 mm Ø 0.157 in
	Gauge	A4			Torque	0.4 - 0.8 N.m 3.5 - 7 lb.in
Rated current / Rated cross section		30 A / 4 mm ²	20 A / 12 AWG			
Rated short-time withstand current (1s)		480 A				
Rated voltage		400 V	300 V			
Impulse withstand voltage		6000 V				
Protection		IP20	NEMA 1			

The connecting capacity data for one Rigid: Solid/Stranded, or one Flexible conductor (when applicable) is a mandatory information required by IEC, UL and CSA standards (Copper conductors). All other data are provided as supplementary information only. For more details, please consult our CB, UL or CSA certificates and technical datasheet available on <http://www.TE.com>

CE	RoHS	UL	Gost R			

Accessories

Description	Color	Type	Part Number	Pkg pce	Weight (1 pce) g
1 End stops 10 mm 0.394 in	Dark grey <input checked="" type="checkbox"/>	BAZH1	1SNK900102R0000	20	24.00
2 End sections 1 mm 0.039 in	Grey <input type="checkbox"/>	FED6	1SNA116964R1200	20	3.00
3 Jumper bars 2 poles 32 A		BJM62	1SNA173217R2600	10	2.00
			1SNA173218R0700	10	3.00
			1SNA173219R0000	10	4.00
			1SNA173221R2200	10	5.00
			1SNA173226R2700	10	10.00
4 Circuit separators 0 mm 0 in	White <input type="checkbox"/>	SCD	1SNA103189R2600	10	1.00
	Grey <input type="checkbox"/>	SCFD	1SNA114117R0700	10	10.00
5 Test sockets DIA 2 mm 0.079 in		AL2	1SNA167319R0600	50	
6 Test plugs DIA 2 mm 0.079 in	Black <input checked="" type="checkbox"/>	FC2	1SNA007865R2600	100	
7 Terminal block markers Blank card	White <input type="checkbox"/>	RC65	1SNA23200R0000	1	3.60

Complete list of accessories is indicated in the terminal block datasheet. Some accessories such as jumper bars may modify the terminal block's ratings: complete information in the accessories catalogue pages.

Technical data valid for copper conductors only.

D4/6.LNTP screw clamp terminal blocks

Installation - 17.8 mm 0.701 in spacing

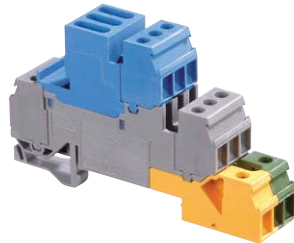
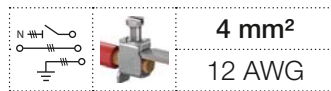

1SN1C161195F0014

D4/6.LNTP

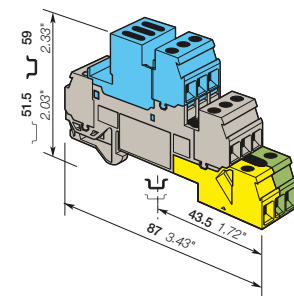

17.8 mm 0.701 in spacing

Description

- Closed terminal block: no end section needed,
- According to DIN 43880 standards (dimension above the rail $35 \times 7.5 \leq 44$ mm),
- Compatible with busbar.

Ordering details

Description	Color	Type	Part Number	Pkg pce	Weight (1 pce) g
Installation 3 disconnect neutral + 3 feed-through + 3 ground	Blue, grey, green-yellow	D4/6.LNTP1	1SNA110264R0200	10	70.00

Main technical data

		IEC	UL	CSA	Mounting instructions	
1 conductor per clamp	Rigid: Solid/Stranded	0.2-4 mm ²	18-12 AWG	18-12 AWG	Rail	TH 35-7.5, TH 35-15
	Flexible without ferrule	0.2-4 mm ²			Wire stripping length	9.5 mm 0.37 in
	Flexible with insulated ferrule				Screw clamp Tool	Flat screwdriver Ø 4 mm Ø 0.157 in
Gauge		A4			Torque	0.5 - 0.8 N.m 4.4 - 7.1 lb.in
Rated current / Rated cross section		30 A / 4 mm ²	20 A / 12 AWG	20 A / 12 AWG	Disconnect device Tool	Flat screwdriver Ø 4 mm Ø 0.157 in
Rated short-time withstand current (1s)		480 A			Torque	0.4 - 0.6 N.m 3.5 - 5.3 lb.in
Rated voltage		320 V	300 V	300 V		
Impulse withstand voltage		4000 V				
Protection		IP20	NEMA 1			

The connecting capacity data for one Rigid: Solid/Stranded, or one Flexible conductor (when applicable) is a mandatory information required by IEC, UL and CSA standards (Copper conductors). All other data are provided as supplementary information only. For more details, please consult our CB, UL or CSA certificates and technical datasheet available on <http://www.TE.com>

CE	RoHS	UR	CSA	PC	Gost R
----	------	----	-----	----	--------

Accessories

Description	Color	Type	Part Number	Pkg pce	Weight (1 pce) g
1 End stops	Dark grey	BAM4	1SNK900001R0000	50	14.00
		BAZ1	1SNK900002R0000	50	5.30
2 Jumper bars		BJM62	1SNA173217R2600	10	2.00
			1SNA173218R0700	10	3.00
			1SNA173219R0000	10	4.00
			1SNA173221R2200	10	5.00
			1SNA173226R2700	10	10.00
3 Circuit separators	White	SCD	1SNA103189R2600	10	1.00
			1SNA114117R0700	10	10.00
4 Test sockets	Grey	AL2	1SNA167319R0600	50	
5 Test plugs	Black	FC2	1SNA007865R2600	100	
6 Clamps		SFB1	1SNA163860R0500	50	12.00
			SFB2	1SNA168956R0600	50
7 Busbars		BO3	1SNA164406R2400	1	
8 Terminal block markers	White	RC65	1SNA232000R0000	1	3.60

Complete list of accessories is indicated in the terminal block datasheet.
Some accessories such as jumper bars may modify the terminal block's ratings: complete information in the accessories catalogue pages.

Technical data valid for copper conductors only.

D4/6.LNTP screw clamp terminal blocks

Installation - 17.8 mm 0.701 in spacing

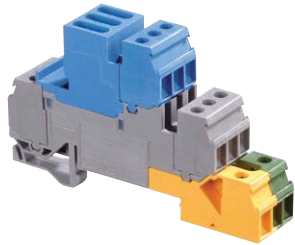

1SN161195F0014

D4/6.LNTP

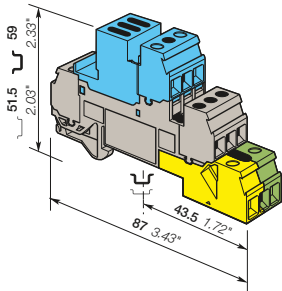

17.8 mm 0.701 in spacing

Description

- Closed terminal block: no end section needed,
- According to DIN 43880 standards (dimension above the rail $35 \times 7.5 \leq 44$ mm),
- Compatible with busbar.

Ordering details

Description	Color	Type	Part Number	Pkg pce	Weight (1 pce)
Installation 1 disconnect neutral + 3 feed-through + 1 ground	Blue, grey, green-yellow	D4/6.LNTP3	1SNA110269R1700	10	70.00

Main technical data

		IEC	UL	CSA
1 conductor per clamp	Rigid: Solid/Stranded	0.2-4 mm ²	18-12 AWG	18-12 AWG
	Flexible without ferrule	0.2-4 mm ²		
	Flexible with insulated ferrule			
Gauge		A4		
Rated current / Rated cross section		30 A / 4 mm ²	20 A / 12 AWG	20 A / 12 AWG
Rated short-time withstand current (1s)		480 A		
Rated voltage		320 V	300 V	300 V
Impulse withstand voltage		4000 V		
Protection		IP20	NEMA 1	

Mounting instructions

Rail		TH 35-7.5, TH 35-15
Wire stripping length		9.5 mm 0.37 in
Screw clamp Tool		Flat screwdriver Ø 4 mm
Torque		0.5 - 0.8 N.m 4.4 - 7.1 lb.in
Disconnect device Tool		Flat screwdriver Ø 4 mm
Torque		Ø 0.157 in 0.4 - 0.6 N.m 3.5 - 5.3 lb.in

The connecting capacity data for one Rigid: Solid/Stranded, or one Flexible conductor (when applicable) is a mandatory information required by IEC, UL and CSA standards (Copper conductors). All other data are provided as supplementary information only. For more details, please consult our CB, UL or CSA certificates and technical datasheet available on <http://www.TE.com>

CE	RoHS	RU	CSA	Gost R
----	------	----	-----	--------

Accessories

Description	Color	Type	Part Number	Pkg pce	Weight (1 pce)
1 End stops	Dark grey	BAM4	1SNK900001R0000	50	14.00
		BAZ1	1SNK900002R0000	50	5.30
2 Jumper bars		BJM62	1SNA173217R2600	10	2.00
			1SNA173218R0700	10	3.00
			1SNA173219R0000	10	4.00
			1SNA173221R2200	10	5.00
			1SNA173226R2700	10	10.00
3 Circuit separators	White	SCD	1SNA103189R2600	10	1.00
			Grey	SCFD	1SNA114117R0700
4 Test sockets		AL2	1SNA167319R0600	50	
5 Test plugs	Black	FC2	1SNA007865R2600	100	
6 Clamps		SFB1	1SNA163860R0500	50	12.00
		SFB2	1SNA168956R0600	50	11.00
7 Busbars		BO3	1SNA164406R2400	1	
8 Terminal block markers	White	RC65	1SNA232000R0000	1	3.60

Complete list of accessories is indicated in the terminal block datasheet.

Some accessories such as jumper bars may modify the terminal block's ratings: complete information in the accessories catalogue pages.

Technical data valid for copper conductors only.

D4/6.LNTP screw clamp terminal blocks

Installation - 17.8 mm 0.701 in spacing

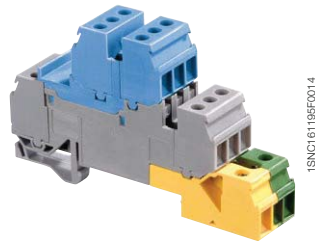
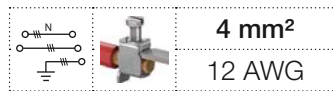

D4/6.LNTP

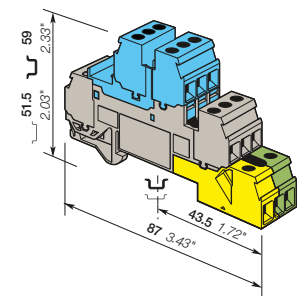

17.8 mm 0.701 in spacing

Description

- Closed terminal block: no end section needed,
- According to DIN 43880 standards (dimension above the rail $35 \times 7.5 \leq 44$ mm),
- Compatible with busbar.

Ordering details

Description	Color	Type	Part Number	Pkg pce	Weight (1 pce) g
Installation 3 neutral + 3 feed-through + 3 ground	Blue, grey, Green-yellow	D4/6.LNTP2	1SNA110327R2100	10	70.00

Main technical data

		IEC	UL	CSA
1 conductor per clamp	Rigid: Solid/Stranded	0.2-4 mm ²	18-12 AWG	18-12 AWG
	Flexible without ferrule	0.2-4 mm ²		
	Flexible with insulated ferrule			
	Gauge	A4		
Rated current / Rated cross section		30 A / 4 mm ²	20 A / 12 AWG	20 A / 12 AWG
Rated short-time withstand current (1s)		480 A		
Rated voltage		400 V	300 V	300 V
Impulse withstand voltage		6000 V		
Protection		IP20	NEMA 1	

Mounting instructions

Rail		TH 35-7.5, TH 35-15
Wire stripping length		9.5 mm 0.37 in
Tool		Flat screwdriver Ø 4 mm Ø 0.157 in
Torque		0.5 - 0.8 N.m 4.4 - 7.1 lb.in

The connecting capacity data for one Rigid: Solid/Stranded, or one Flexible conductor (when applicable) is a mandatory information required by IEC, UL and CSA standards (Copper conductors). All other data are provided as supplementary information only. For more details, please consult our CB, UL or CSA certificates and technical datasheet available on <http://www.TE.com>

CE	RoHS	UL	CSA	Gost R

Accessories

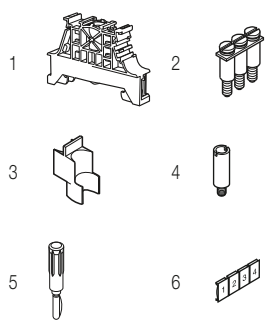

Description	Color	Type	Part Number	Pkg pce	Weight (1 pce) g
1 End stops	Dark grey	BAM4	1SNK900001R0000	50	14.00
		BAZ1	1SNK900002R0000	50	5.30
2 Jumper bars		BJM62	1SNA173217R2600	10	2.00
			1SNA173218R0700	10	3.00
			1SNA173219R0000	10	4.00
			1SNA173221R2200	10	5.00
			1SNA173226R2700	10	10.00
3 Circuit separators	White	SCD	1SNA103189R2600	10	1.00
		SCFD	1SNA114117R0700	10	10.00
4 Test sockets		AL2	1SNA167319R0600	50	
5 Test plugs	Black	FC2	1SNA007865R2600	100	
6 Terminal block markers	White	RC65	1SNA232000R0000	1	3.60

Complete list of accessories is indicated in the terminal block datasheet. Some accessories such as jumper bars may modify the terminal block's ratings: complete information in the accessories catalogue pages.

Technical data valid for copper conductors only.

D4/6.LNTP screw clamp terminal blocks

Installation - 17.8 mm 0.701 in spacing

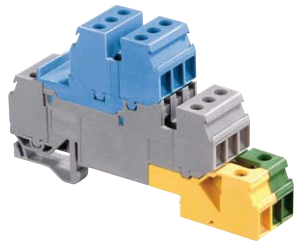
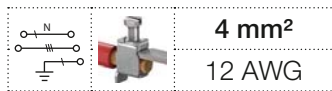

D4/6.LNTP

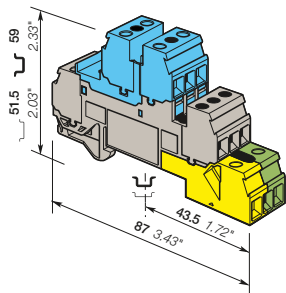

17.8 mm 0.701 in spacing

Description

- Closed terminal block: no end section needed.
- According to DIN 43880 standards (dimension above the rail $35 \times 7.5 \leq 44$ mm),
- Compatible with busbar.

Ordering details

Description	Color	Type	Part Number	Pkg pce	Weight (1 pce)
Installation 1 neutral + 3 feed-through + 1 ground	Blue, Grey, Green-Yellow	D4/6.LNTP8	1SNA110333R2700	10	60.00

Main technical data

		IEC	UL	CSA
1 conductor per clamp	Rigid: Solid/Stranded	0.2-4 mm ²	18-12 AWG	18-12 AWG
	Flexible without ferrule	0.2-4 mm ²		
	Flexible with insulated ferrule			
	Gauge	A4		
Rated current / Rated cross section		30 A / 4 mm ²	20 A / 12 AWG	20 A / 12 AWG
Rated short-time withstand current (1s)		480 A		
Rated voltage		400 V	300 V	300 V
Impulse withstand voltage		6000 V		
Protection		IP20	NEMA 1	

Mounting instructions

Rail		TH 35-7.5, TH 35-15
Wire stripping length		9.5 mm 0.37 in
Tool		Flat screwdriver Ø 4 mm Ø 0.157 in
Torque		0.4 - 0.8 N.m 3.5 - 7 lb.in

The connecting capacity data for one Rigid: Solid/Stranded, or one Flexible conductor (when applicable) is a mandatory information required by IEC, UL and CSA standards (Copper conductors). All other data are provided as supplementary information only. For more details, please consult our CB, UL or CSA certificates and technical datasheet available on <http://www.TE.com>

CE	RoHS	UL	CSA	Gost R
CE	RoHS	UL	CSA	Gost R

Accessories

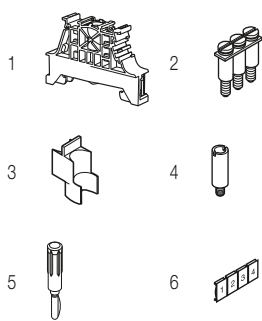

Description	Color	Type	Part Number	Pkg pce	Weight (1 pce)
1 End stops	Dark grey	BAM4	1SNK900001R0000	50	14.00
		BAZ1	1SNK900002R0000	50	5.30
2 Jumper bars	Grey	2 poles	1SNA173217R2600	10	2.00
		3 poles	1SNA173218R0700	10	3.00
		4 poles	1SNA173219R0000	10	4.00
		5 poles	1SNA173221R2200	10	5.00
		10 poles	1SNA173226R2700	10	10.00
3 Circuit separators	White	SCD	1SNA103189R2600	10	1.00
		SCFD	1SNA114117R0700	10	10.00
4 Test sockets	Grey	AL2	1SNA167319R0600	50	
5 Test plugs	Black	FC2	1SNA007865R2600	100	
6 Terminal block markers	White	RC65	1SNA232000R0000	1	3.60

Complete list of accessories is indicated in the terminal block datasheet. Some accessories such as jumper bars may modify the terminal block's ratings: complete information in the accessories catalogue pages.

Technical data valid for copper conductors only.

D4/6.LNTP screw clamp terminal blocks

Installation - 17.8 mm 0.701 in spacing

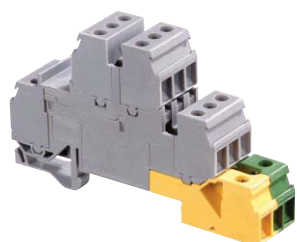
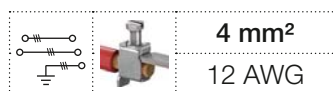

1SNIC161202FC014

D4/6.LNTP

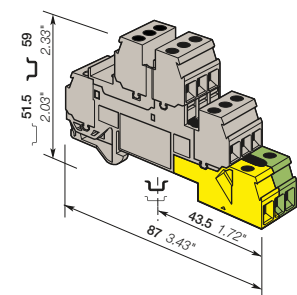

17.8 mm 0.701 in spacing

Description

- Closed terminal block: no end section needed,
- According to DIN 43880 standards (dimension above the rail $35 \times 7.5 \leq 44$ mm),
- Compatible with busbar.

Ordering details

Description	Color	Type	Part Number	Pkg pce	Weight (1 pce) g
Installation 6 feed-through + 3 ground	Grey, Green-yellow	D4/6.LNTP4	1SNA110328R0200	10	70.00

Main technical data

		IEC	UL	CSA
1 conductor per clamp	Rigid: Solid/Stranded	0.2-4 mm ²	18-12 AWG	18-12 AWG
	Flexible without ferrule	0.2-4 mm ²		
	Flexible with insulated ferrule			
Gauge		A4		
Rated current / Rated cross section		30 A / 4 mm ²	20 A / 12 AWG	20 A / 12 AWG
Rated short-time withstand current (1s)		480 A		
Rated voltage		400 V	300 V	300 V
Impulse withstand voltage		6000 V		
Protection		IP20	NEMA 1	

Mounting instructions

Rail		TH 35-7.5, TH 35-15
Wire stripping length		9.5 mm 0.37 in
Tool		Flat screwdriver Ø 4 mm Ø 0.157 in
Torque		0.5 - 0.8 N.m 4.4 - 7.1 lb.in

The connecting capacity data for one Rigid: Solid/Stranded, or one Flexible conductor (when applicable) is a mandatory information required by IEC, UL and CSA standards (Copper conductors). All other data are provided as supplementary information only. For more details, please consult our CB, UL or CSA certificates and technical datasheet available on <http://www.TE.com>

CE	RoHS	UL	CSA	Gost R

Accessories

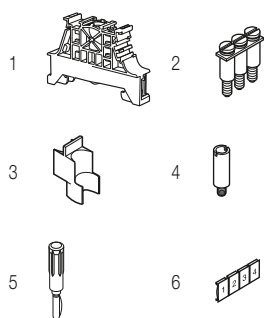

Description	Color	Type	Part Number	Pkg pce	Weight (1 pce) g
1 End stops	Dark grey	BAM4	1SNK900001R0000	50	14.00
		BAZ1	1SNK900002R0000	50	5.30
2 Jumper bars		BJM62	1SNA173217R2600	10	2.00
			1SNA173218R0700	10	3.00
			1SNA173219R0000	10	4.00
			1SNA173221R2200	10	5.00
			1SNA173226R2700	10	10.00
3 Circuit separators	White	SCD	1SNA103189R2600	10	1.00
		SCFD	1SNA114117R0700	10	10.00
4 Test sockets		AL2	1SNA167319R0600	50	
5 Test plugs	Black	FC2	1SNA007865R2600	100	
6 Terminal block markers	White	RC65	1SNA232000R0000	1	3.60

Complete list of accessories is indicated in the terminal block datasheet.
Some accessories such as jumper bars may modify the terminal block's ratings: complete information in the accessories catalogue pages.

Technical data valid for copper conductors only.

D4/6.LNTP screw clamp terminal blocks

Installation - 17.8 mm 0.701 in spacing

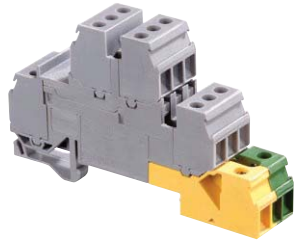
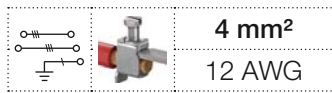

1SNC161202P0014

D4/6.LNTP

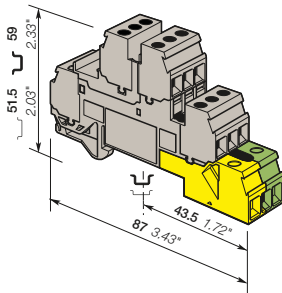

17.8 mm 0.701 in spacing

Description

- Closed terminal block: no end section needed,
- According to DIN 43880 standards (dimension above the rail $35 \times 7.5 \leq 44$ mm),
- Compatible with busbar.

Ordering details

Description	Color	Type	Part Number	Pkg pce	Weight (1 pce)
Installation 6 feed-through + 1 ground	Grey, Green-yellow	D4/6.LNTP7	1SNA110332R2600	10	60.00

Main technical data

		IEC	UL	CSA	Mounting instructions	
1 conductor per clamp	Rigid: Solid/Stranded	0.2-4 mm ²	18-12 AWG	18-12 AWG	Rail	TH 35-7.5, TH 35-15
	Flexible without ferrule	0.2-4 mm ²			Wire stripping length	9.5 mm 0.37 in
	Flexible with insulated ferrule				Tool	Flat screwdriver Ø 4 mm Ø 0.157 in
	Gauge	A4			Torque	0.4 - 0.8 N.m 3.5 - 7 lb.in
Rated current / Rated cross section		30 A / 4 mm ²	20 A / 12 AWG	20 A / 12 AWG		
Rated short-time withstand current (1s)		480 A				
Rated voltage		400 V	300 V	300 V		
Impulse withstand voltage		6000 V				
Protection		IP20	NEMA 1			

The connecting capacity data for one Rigid: Solid/Stranded, or one Flexible conductor (when applicable) is a mandatory information required by IEC, UL and CSA standards (Copper conductors). All other data are provided as supplementary information only. For more details, please consult our CB, UL or CSA certificates and technical datasheet available on <http://www.TE.com>

CE	RoHS	USR CNR	CSA	Gost-R
----	------	---------	-----	--------

Accessories

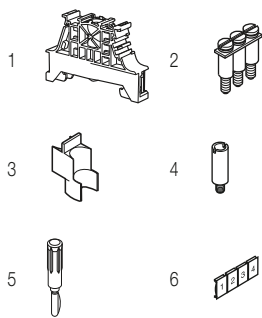

Description	Color	Type	Part Number	Pkg pce	Weight (1 pce)
1 End stops	Dark grey	BAM4	1SNK900001R0000	50	14.00
		BAZ1	1SNK900002R0000	50	5.30
2 Jumper bars		2 poles	1SNA173217R2600	10	2.00
		3 poles	1SNA173218R0700	10	3.00
		4 poles	1SNA173219R0000	10	4.00
		5 poles	1SNA173221R2200	10	5.00
		10 poles	1SNA173226R2700	10	10.00
3 Circuit separators	White	SCD	1SNA103189R2600	10	1.00
		SCFD	1SNA114117R0700	10	10.00
4 Test sockets	Grey	AL2	1SNA167319R0600	50	
5 Test plugs	Black	FC2	1SNA007865R2600	100	
6 Terminal block markers	White	RC65	1SNA232000R0000	1	3.60

Complete list of accessories is indicated in the terminal block datasheet. Some accessories such as jumper bars may modify the terminal block's ratings: complete information in the accessories catalogue pages.

Technical data valid for copper conductors only.

D4/6.LNTP screw clamp terminal blocks

Installation - 17.8 mm 0.701 in spacing

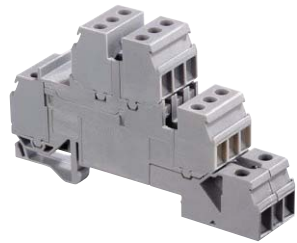
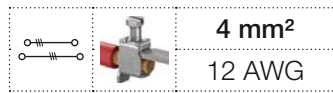

D4/6.LNTP

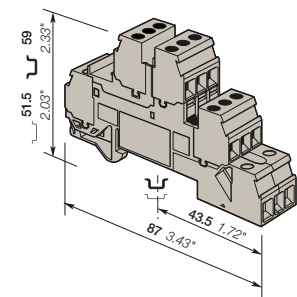

17.8 mm 0.701 in spacing

Description

- Closed terminal block: no end section needed,
- According to DIN 43880 standards (dimension above the rail $35 \times 7.5 \leq 44$ mm),
- Compatible with busbar.

Ordering details

Description	Color	Type	Part Number	Pkg pce	Weight (1 pce) g
Installation 6 feed-through	Grey <input type="checkbox"/>	D4/6.LNTP6	1SNA110331R2500	10	63.10

Main technical data

		IEC	UL	CSA
1 conductor per clamp	Rigid: Solid/Stranded	0.2-4 mm ²	18-12 AWG	18-12 AWG
	Flexible without ferrule	0.2-4 mm ²		
	Flexible with insulated ferrule			
Gauge		A4		
Rated current / Rated cross section		30 A / 4 mm ²	20 A / 12 AWG	20 A / 12 AWG
Rated short-time withstand current (1s)		480 A		
Rated voltage		400 V	300 V	300 V
Impulse withstand voltage		6000 V		
Protection		IP20	NEMA 1	

Mounting instructions

Rail		TH 35-7.5, TH 35-15
Wire stripping length		9.5 mm 0.37 in
Tool		Flat screwdriver Ø 4 mm Ø 0.157 in
Torque		0.4 - 0.8 N.m 3.5 - 7 lb.in

The connecting capacity data for one Rigid: Solid/Stranded, or one Flexible conductor (when apply) is a mandatory information required by IEC, UL and CSA standards (Copper conductors). All other data are provided as supplementary information only. For more details, please consult our CB, UL or CSA certificates and technical datasheet available on <http://www.TE.com>

CE	RoHS	UL	CSA	Gost R

Accessories

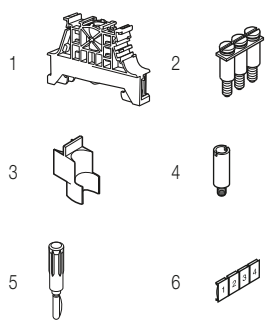

Description	Color	Type	Part Number	Pkg pce	Weight (1 pce) g
1 End stops	Dark grey <input checked="" type="checkbox"/>	BAM4	1SNK900001R0000	50	14.00
		BAZ1	1SNK900002R0000	50	5.30
2 Jumper bars		BJM62	1SNA173217R2600	10	2.00
			1SNA173218R0700	10	3.00
			1SNA173219R0000	10	4.00
			1SNA173221R2200	10	5.00
			1SNA173226R2700	10	10.00
3 Circuit separators	White <input type="checkbox"/>	SCD	1SNA103189R2600	10	1.00
		SCFD	1SNA114117R0700	10	10.00
4 Test sockets		AL2	1SNA167319R0600	50	
5 Test plugs	Black <input checked="" type="checkbox"/>	FC2	1SNA007865R2600	100	
6 Terminal block markers	White <input type="checkbox"/>	RC65	1SNA232000R0000	1	3.60

Complete list of accessories is indicated in the terminal block datasheet. Some accessories such as jumper bars may modify the terminal block's ratings: complete information in the accessories catalogue pages.

Technical data valid for copper conductors only.

D4/6.A.NTLP screw clamp terminal blocks

Installation - 6 mm 0.236 in spacing

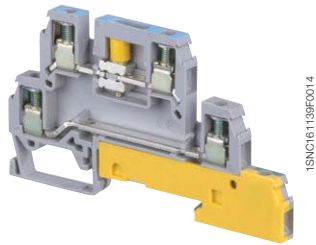
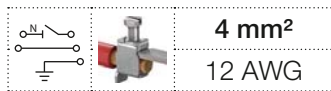

D4/6.A.NTLP

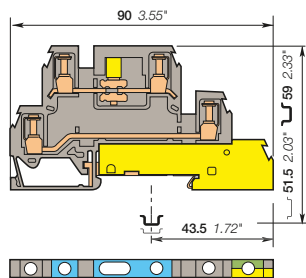

6 mm 0.236 in spacing

Description

According to DIN 43880 standards (dimension above the rail $35 \times 7.5 \leq 44$ mm).

Ordering details

Description	Color	Type	Part Number	Pkg pce	Weight (1 pce) g
Installation Disconnect neutral + feed-through + ground	Grey, blue, Green-yellow	D4/6.A.NTLP	1SNA110415R1200	10	

Main technical data

	IEC	UL	CSA	Mounting instructions	
1 conductor per clamp	Rigid: Solid/Stranded Flexible without ferrule Flexible with insulated ferrule Gauge	0.2-4 mm ² 0.2-4 mm ² A4	18-12 AWG	Rail	G32, TH 35-7.5, TH 35-15
				Wire stripping length	9.5 mm 0.37 in
				Screw clamp Tool	Flat screwdriver Ø 4 mm Ø 0.157 in
				Torque	0.4 - 0.8 Nm 3.5 - 7 lb.in
Rated current / Rated cross section	30 A / 4 mm ²	20 A / 12 AWG		Disconnect device Tool	Flat screwdriver Ø 4 mm Ø 0.157 in
Rated short-time withstand current (1s)	480 A			Torque	0.4 - 0.6 N.m 3.5 - 5.3 lb.in
Rated voltage	320 V	300 V			
Impulse withstand voltage	4000 V				
Protection	IP20	NEMA 1			

The connecting capacity data for one Rigid: Solid/Stranded, or one Flexible conductor (when applicable) is a mandatory information required by IEC, UL and CSA standards (Copper conductors). All other data are provided as supplementary information only. For more details, please consult our CB, UL or CSA certificates and technical datasheet available on <http://www.TE.com>

CE	RoHS	USR CNR	Gost R						
----	------	---------	--------	--	--	--	--	--	--

Accessories

Description	Color	Type	Part Number	Pkg pce	Weight (1 pce) g
1 End stops	Dark grey	BAZH1	1SNK900102R0000	20	24.00
2 End sections	Grey	FEDA6	1SNA116965R1300	20	3.00
3 Jumper bars		BJM62	1SNA173217R2600 1SNA173218R0700 1SNA173219R0000 1SNA173221R2200 1SNA173226R2700	10 10 10 10 10	2.00 3.00 4.00 5.00 10.00
4 Circuit separators	White	SCD	1SNA103189R2600	10	1.00
	Grey	SCFD	1SNA114117R0700	10	10.00
5 Test sockets		AL2	1SNA167319R0600	50	
6 Test plugs	Black	FC2	1SNA007865R2600	100	
7 Terminal block markers	White	RC65	1SNA23200R0000	1	3.60

Complete list of accessories is indicated in the terminal block datasheet. Some accessories such as jumper bars may modify the terminal block's ratings: complete information in the accessories catalogue pages.

Technical data valid for copper conductors only.

D4/6.A.LL screw clamp terminal blocks

Installation - 6 mm 0.236 in spacing

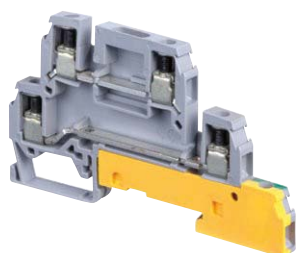
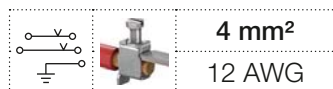

D4/6.A.LL

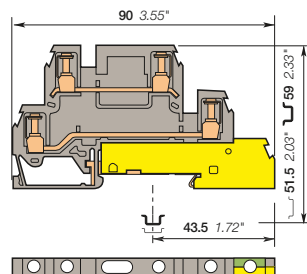

6 mm 0.236 in spacing

Description

According to DIN 43880 standards (dimension above the rail 35 x 7.5 ≤ 44 mm).

Ordering details

Description	Color	Type	Part Number	Pkg pce	Weight (1 pce) g
Installation	2 feed-through + ground	Grey, Green-yellow	D4/6.A.LLP	1SNA110418R2500	20 20.00

Main technical data

	IEC	UL	CSA
1 conductor per clamp	Rigid: Solid/Stranded	0.2-4 mm ²	18-12 AWG
	Flexible without ferrule	0.2-4 mm ²	
	Flexible with insulated ferrule		
	Gauge	A4	
Rated current / Rated cross section	30 A / 4 mm ²	20 A / 12 AWG	
Rated short-time withstand current (1s)	480 A		
Rated voltage	400 V	300 V	
Impulse withstand voltage	6000 V		
Protection	IP20	NEMA 1	

Mounting instructions

Rail		G32, TH 35-7.5, TH 35-15
Wire stripping length		9.5 mm 0.37 in
Screw clamp Tool		Flat screwdriver Ø 4 mm Ø 0.157 in
Torque		0.4 - 0.8 Nm 3.5 - 7 lb.in
Disconnect device Tool		
Torque		

The connecting capacity data for one Rigid: Solid/Stranded, or one Flexible conductor (when applicable) is a mandatory information required by IEC, UL and CSA standards (Copper conductors). All other data are provided as supplementary information only. For more details, please consult our CB, UL or CSA certificates and technical datasheet available on <http://www.TE.com>

CE	RoHS	UL	Gost R

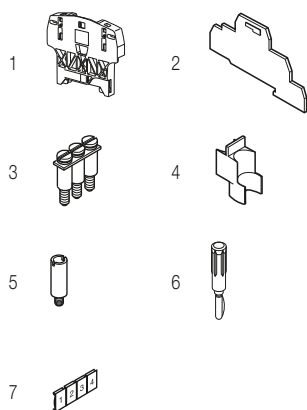

Accessories

Description	Color	Type	Part Number	Pkg pce	Weight (1 pce) g	
1 End stops	Dark grey	BAZH1	1SNK900102R0000	20	24.00	
2 End sections	Grey	FEDA6	1SNA116965R1300	20	3.60	
3 Jumper bars		BJM62	2 poles	1SNA173217R2600	10	2.00
			3 poles	1SNA173218R0700	10	3.00
			4 poles	1SNA173219R0000	10	4.00
			5 poles	1SNA173221R2200	10	5.00
			10 poles	1SNA173226R2700	10	10.00
4 Circuit separators	White	SCD	1SNA103189R2600	10	1.00	
	Grey	SCFD	1SNA114117R0700	10	10.00	
5 Test sockets		AL2	1SNA167319R0600	50		
6 Test plugs	Black	FC2	1SNA007865R2600	100		
7 Terminal block markers	White	RC65	1SNA232000R0000	1	3.60	

Complete list of accessories is indicated in the terminal block datasheet. Some accessories such as jumper bars may modify the terminal block's ratings: complete information in the accessories catalogue pages.

Technical data valid for copper conductors only.

MA2.5/5.NT screw clamp terminal blocks

Neutral disconnect - 5 mm 0.197 in spacing

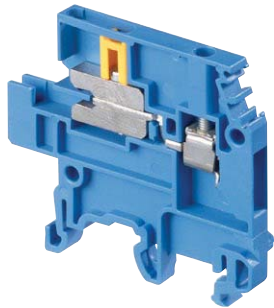

MA2.5/5.NT

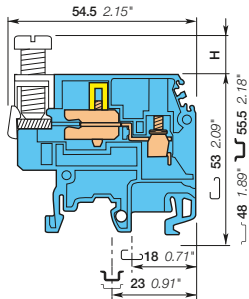

5 mm 0.197 in spacing

Description

- Ease the disconnection of your neutral circuits,
- Compatible with screw clamp terminal blocks, wire size 2.5 mm² (5 mm 0.200 in spacing) to 16 mm² (12 mm 0.473 in spacing).

Ordering details

Description	Color	Type	Part Number	Pkg pce	Weight (1 pce) g
Neutral disconnect For busbar 10 x 3 mm	Blue	MA2.5/5.NT	1SNA125487R0600	50	12.00

Main technical data

		IEC	UL	CSA	Mounting instructions	
1 conductor per clamp	Rigid: Solid/Stranded	0.2-4 mm ²			Rail	G32, TH 35-7.5, TH 35-15
	Flexible without ferrule	0.22-2.5 mm ²			Wire stripping length	10 mm 0.39 in
	Flexible with insulated ferrule				Screw clamp Tool	Flat screwdriver Ø 3.5 mm Ø 0.14 in
	Gauge	A3			Torque	0.4 - 0.6 N.m 3.5 - 5.3 lb.in
Rated current / Rated cross section		24 A / 2.5 mm ²			Disconnect device Tool	Flat screwdriver Ø 4 mm Ø 0.16 in
Rated short-time withstand current (1s)		300 A			Torque	0.4 - 0.6 N.m 3.5 - 5.3 lb.in
Rated voltage		400 V				
Impulse withstand voltage		6000 V				
Protection			NEMA			

The connecting capacity data for one Rigid: Solid/Stranded, or one Flexible conductor (when applicable) is a mandatory information required by IEC, UL and CSA standards (Copper conductors). All other data are provided as supplementary information only, for more details, please consult our CB, UL or CSA certificates and technical datasheet available on <http://www.TE.com>

CE	RoHS	Gost R				
----	------	--------	--	--	--	--

Accessories

Description	Color	Type	Part Number	Pkg pce	Weight (1 pce) g
1 End stops	Dark grey	BAM4	1SNK900001R0000	50	14.00
		BAZ1	1SNK900002R0000	50	5.30
2 End sections	Grey	FEM6	1SNA118368R1600	20	2.40
3 Test adapters	Green	DCV	1SNA173058R0200	10	2.20
4 Test plugs	Black	FC2	1SNA007865R2600	100	
5 Locking devices	Blue	VRB3	1SNA128035R1600	10	
6 Clamps		SFB1	1SNA163860R0500	50	12.00
		SFB2	1SNA168956R0600	50	11.00
7 Busbars		BO3	1SNA164406R2400	1	
8 Terminal block markers	White	RC510	1SNA231000R0700	1	5.20

Complete list of accessories is indicated in the terminal block datasheet.

Some accessories such as jumper bars may modify the terminal block's ratings: complete information in the accessories catalogue pages.

Technical data valid for copper conductors only

M4/6.NT screw clamp terminal blocks

Neutral disconnect - 6 mm 0.236 in spacing

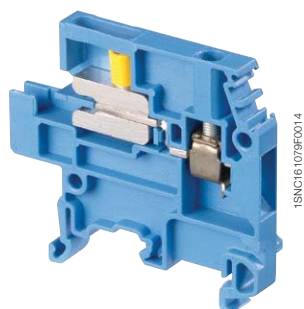

M4/6.NT

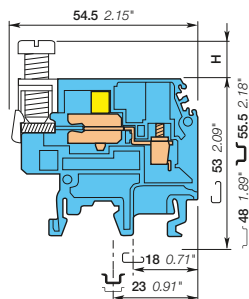

6 mm 0.236 in spacing

Description

- Ease the disconnection of your neutral circuits,
- Compatible with screw clamp terminal blocks, wire size 2.5 mm² (5 mm 0.200 in spacing) to 16 mm² (12 mm 0.473 in spacing).

Ordering details

Description	Color	Type	Part Number	Pkg pce	Weight (1 pce) g
Neutral disconnect For busbar 10 x 3 mm	Blue	M4/6.NT	1SNA125117R0200	50	13.00

Main technical data

	IEC	UL	CSA
1 conductor per clamp	Rigid: Solid/Stranded Flexible without ferrule Flexible with insulated ferrule Gauge	0.2-4 mm ² 0.22-4 mm ² A4	18-12 AWG
Rated current / Rated cross section	32 A / 4 mm ²		25 A / 12 AWG
Rated short-time withstand current (1s)	480 A		
Rated voltage	400 V		300 V
Impulse withstand voltage	6000 V		
Protection		NEMA	

Mounting instructions

	Tool	Dimensions
Rail		G32, TH 35-7.5, TH 35-15
Wire stripping length		12 mm 0.47 in
Screw clamp		Flat screwdriver Ø 4 mm Ø 0.157 in
Torque		0.5 - 0.8 N.m 4.4 - 7.1 lb.in
Disconnect device		Flat screwdriver Ø 4 mm Ø 0.157 in
Torque		0.4 - 0.6 N.m 3.5 - 5.3 lb.in

The connecting capacity data for one Rigid: Solid/Stranded, or one Flexible conductor (when applicable) is a mandatory information required by IEC, UL and CSA standards (Copper conductors). All other data are provided as supplementary information only. For more details, please consult our CB, UL or CSA certificates and technical datasheet available on <http://www.TE.com>

CE	RoHS	CSA	Gost R						

Accessories

Description	Color	Type	Part Number	Pkg pce	Weight (1 pce) g
1 End stops	Dark grey	BAM4	1SNK900001R0000	50	14.00
		BAZ1	1SNK900002R0000	50	5.30
2 End sections	Grey	FEM6	1SNA118368R1600	20	2.40
3 Test adapters	Green	DCV	1SNA173058R0200	10	2.20
4 Test plugs	Black	FC2	1SNA007865R2600	100	
5 Locking devices	Blue	VRB3	1SNA128035R1600	10	
6 Clamps		SFB1	1SNA163860R0500	50	12.00
		SFB2	1SNA168956R0600	50	11.00
7 Busbars		BO3	1SNA164406R2400	1	
8 Terminal block markers	White	RC610	1SNA233000R0100	1	7.50

Complete list of accessories is indicated in the terminal block datasheet. Some accessories such as jumper bars may modify the terminal block's ratings: complete information in the accessories catalogue pages.

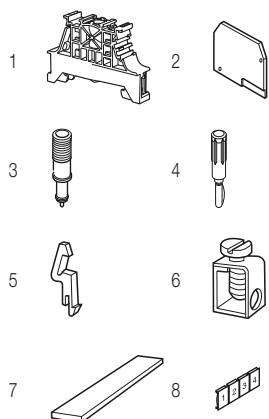

Technical data valid for copper conductors only.

M6/8.NT screw clamp terminal blocks

Neutral disconnect - 8 mm 0.315 in spacing

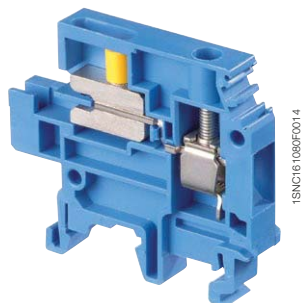

M6/8.NT

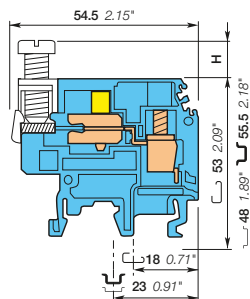

8 mm 0.315 in spacing

Description

- Ease the disconnection of your neutral circuits,
- Compatible with screw clamp terminal blocks, wire size 2.5 mm² (5 mm 0.200 in spacing) to 16 mm² (12 mm 0.473 in spacing).

Ordering details

Description	Color	Type	Part Number	Pkg pce	Weight (1 pce) g
Neutral disconnect For busbar 10 x 3 mm	Blue <input checked="" type="checkbox"/>	M6/8.NT	1SNA125119R1400	50	17.00

Main technical data

		IEC	UL	CSA
1 conductor per clamp	Rigid: Solid/Stranded	0.5-10 mm ²		18-8 AWG
	Flexible without ferrule	0.5-6 mm ²		
	Flexible with insulated ferrule			
Gauge		A5		
Rated current / Rated cross section		41 A / 6 mm ²		50 A / 8 AWG
Rated short-time withstand current (1s)		720 A		
Rated voltage		400 V		300 V
Impulse withstand voltage		6000 V		
Protection			NEMA	

Mounting instructions

Rail		G32, TH 35-7.5, TH 35-15
Wire stripping length		12 mm 0.47 in
Screw clamp Tool		Flat screwdriver Ø 4-5 mm Ø 0.16-0.20 in
Torque		0.8 - 1 N.m 7.1 - 8.9 lb.in
Disconnect device Tool		Flat screwdriver Ø 4 mm
Torque		Ø 0.16 in 3.5 - 5.3 lb.in

The connecting capacity data for one Rigid: Solid/Stranded, or one Flexible conductor (when applicable) is a mandatory information required by IEC, UL and CSA standards (Copper conductors). All other data are provided as supplementary information only. For more details, please consult our CB, UL or CSA certificates and technical datasheet available on <http://www.TE.com>

CE	RoHS	CSA	Gost R

Accessories

Description	Color	Type	Part Number	Pkg pce	Weight (1 pce) g
1 End stops	Dark grey <input checked="" type="checkbox"/>	BAM4	1SNK900001R0000	50	14.00
		BAZ1	1SNK900002R0000	50	5.30
2 End sections	Grey <input type="checkbox"/>	FEM6	1SNA118368R1600	20	2.40
3 Test plugs	Black <input checked="" type="checkbox"/>	FC2	1SNA007865R2600	100	
4 Locking devices	Blue <input checked="" type="checkbox"/>	VRB3	1SNA128035R1600	10	
5 Clamps		SFB1	1SNA163860R0500	50	12.00
		SFB2	1SNA168956R0600	50	11.00
6 Busbars		BC3	1SNA164406R2400	1	
7 Terminal block markers	White <input type="checkbox"/>	RC810	1SNA234000R0200	1	8.20

Complete list of accessories is indicated in the terminal block datasheet. Some accessories such as jumper bars may modify the terminal block's ratings: complete information in the accessories catalogue pages.

Technical data valid for copper conductors only

M10/10.NT screw clamp terminal blocks

Neutral disconnect - 10 mm 0.394 in spacing

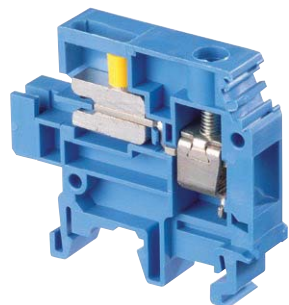

M10/10.NT

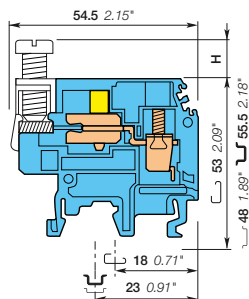

10 mm 0.394 in spacing

Description

- Ease the disconnection of your neutral circuits,
- Compatible with screw clamp terminal blocks, wire size 2.5 mm² (5 mm 0.200 in spacing) to 16 mm² (12 mm 0.473 in spacing).

Ordering details

Description	Color	Type	Part Number	Pkg pce	Weight (1 pce) g
Neutral disconnect For busbar 10 x 3 mm	Blue	M10/10.NT	1SNA125121R0600	50	19.00

Main technical data

		IEC	UL	CSA	Mounting instructions	
1 conductor per clamp	Rigid: Solid/Stranded	0.5-16 mm ²		18-6 AWG	Rail	G32, TH 35-7.5, TH 35-15
	Flexible without ferrule	0.5-10 mm ²			Wire stripping length	12 mm 0.47 in
	Flexible with insulated ferrule				Screw clamp Tool	Flat screwdriver Ø 5.5-6 mm Ø 0.22-0.24 in
	Gauge	B6			Torque	1.2 - 1.4 N.m 10.6 - 12.3 lb.in
Rated current / Rated cross section		57 A / 10 mm ²		75 A / 6 AWG	Disconnect device Tool	Flat screwdriver Ø 4 mm Ø 0.16 in
Rated short-time withstand current (1s)		1200 A			Torque	0.4 - 0.6 N.m 3.5 - 5.3 lb.in
Rated voltage		400 V		300 V		
Impulse withstand voltage		6000 V				
Protection			NEMA			

The connecting capacity data for one Rigid: Solid/Stranded, or one Flexible conductor (when applicable) is a mandatory information required by IEC, UL and CSA standards (Copper conductors). All other data are provided as supplementary information only. For more details, please consult our CB, UL or CSA certificates and technical datasheet available on <http://www.TE.com>

CE	RoHS	CSA	Gost R						

Accessories

Description	Color	Type	Part Number	Pkg pce	Weight (1 pce) g
1 End stops	Dark grey	BAM4	1SNK900001R0000	50	14.00
		BAZ1	1SNK900002R0000	50	5.30
2 End sections	Grey	FEM6	1SNA118368R1600	20	2.40
3 Locking devices	Blue	VRB3	1SNA128035R1600	10	
4 Clamps		SFB1	1SNA163860R0500	50	12.00
		SFB2	1SNA168956R0600	50	11.00
5 Busbars		BO3	1SNA164406R2400	1	
6 Terminal block markers	White	RC1010	1SNA238000R1600	1	1.30

Complete list of accessories is indicated in the terminal block datasheet. Some accessories such as jumper bars may modify the terminal block's ratings: complete information in the accessories catalogue pages.

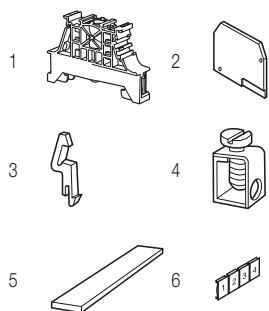

Technical data valid for copper conductors only

M16/12.NT screw clamp terminal blocks

Neutral disconnect - 12 mm 0.472 in spacing

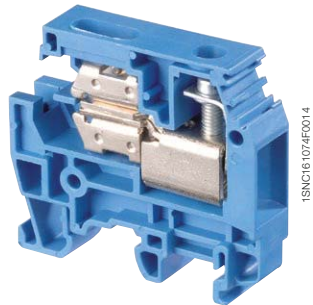
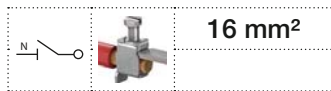

M16/12.NT

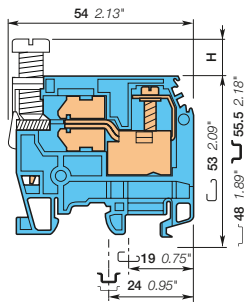

12 mm 0.472 in spacing

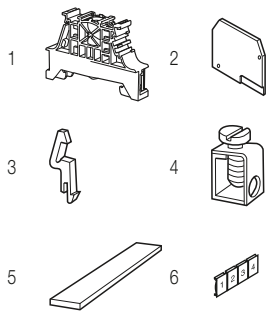

Description

- Ease the disconnection of your neutral circuits,
- Compatible with screw clamp terminal blocks, wire size 2.5 mm² (5 mm 0.200 in spacing) to 16 mm² (12 mm 0.473 in spacing).

Ordering details

Description	Color	Type	Part Number	Pkg pce	Weight (1 pce) g
Neutral disconnect For busbar 10 x 3 mm	Blue <input type="checkbox"/>	M16/12.NT1	1SNA125593R0000	20	26.00

Main technical data

		IEC	UL	CSA
1 conductor per clamp	Rigid: Solid/Stranded	2.5-25 mm ²		
	Flexible without ferrule	2.5-16 mm ²		
	Flexible with insulated ferrule			
	Gauge	B7		
Rated current / Rated cross section		76 A / 16 mm ²		
Rated short-time withstand current (1s)		1920 A		
Rated voltage		400 V		
Impulse withstand voltage		6000 V		
Protection			NEMA	

Mounting instructions

Rail		G32, TH 35-7.5, TH 35-15
Wire stripping length		14 mm 0.51 in
Screw clamp Tool		Flat screwdriver Ø 5.5 mm Ø 0.22 in
Torque		1.2 - 1.4 N.m 10.6 - 12.3 lb.in
Disconnect device Tool		Flat screwdriver Ø 4 mm Ø 0.16 in
Torque		0.5 - 0.8 N.m 4.4 - 7.1 lb.in

The connecting capacity data for one Rigid: Solid/Stranded, or one Flexible conductor (when applicable) is a mandatory information required by IEC, UL and CSA standards (Copper conductors). All other data are provided as supplementary information only, for more details, please consult our CB, UL or CSA certificates and technical datasheet available on <http://www.TE.com>

CE	RoHS	Gost R					

Accessories

Description	Color	Type	Part Number	Pkg pce	Weight (1 pce) g	
1 End stops	Dark grey <input type="checkbox"/>	BAM4	1SNK900001R0000	50	14.00	
		BAZ1	1SNK900002R0000	50	5.30	
2 End sections	Grey <input type="checkbox"/>	FEM6	1SNA118368R1600	20	2.40	
3 Locking devices	Blue <input type="checkbox"/>	For busbar BO3	VRB3	1SNA128035R1600	10	
		For busbar BO6	VRB6	1SNA128361R0100	20	
4 Clamps		0.5-35 mm ² 18-2 AWG	SFB1	1SNA163860R0500	50	12.00
		16-35 mm ² 6-2 AWG	SFB2	1SNA168956R0600	50	11.00
5 Busbars		Busbars	BO3	1SNA164406R2400	1	
6 Terminal block markers	White <input type="checkbox"/>	Blank card	RC1010	1	1.30	

Complete list of accessories is indicated in the terminal block datasheet.

Some accessories such as jumper bars may modify the terminal block's ratings: complete information in the accessories catalogue pages.

Technical data valid for copper conductors only

M35/16.NT screw clamp terminal blocks

Neutral disconnect - 17 mm 0.669 in spacing

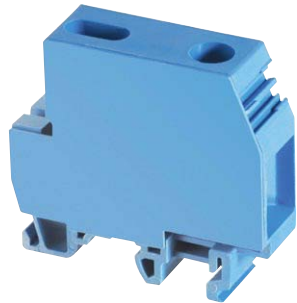

M35/16.NT

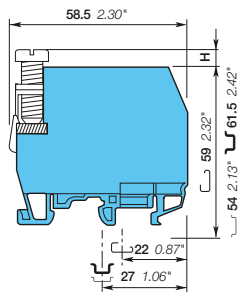

17 mm 0.669 in spacing

Description

- Ease the disconnection of your neutral circuits,
- Close terminal block, no end section needed,
- Compatible with screw clamp terminal blocks, wire size 2.5 mm² (5 mm 0.200 in spacing) to 16 mm² (12 mm 0.473 in spacing).

Ordering details

Description	Color	Type	Part Number	Pkg pce	Weight (1 pce) g
Neutral disconnect For busbar 10 x 3 mm	Blue ■	M35/16.NT	1SNA125358R0300	20	60.00

Main technical data

		IEC	UL	CSA	Mounting instructions	
1 conductor per clamp	Rigid: Solid/Stranded	10-50 mm ²			Rail	G32, TH 35-7.5, TH 35-15
	Flexible without ferrule	10-35 mm ²			Wire stripping length	17 mm 0.67 in
	Flexible with insulated ferrule				Screw clamp Tool	Flat screwdriver Ø 6.5-7 mm Ø 0.256 - 0.276 in
	Gauge	B9			Torque	2.8 - 3 Nm 24.6 - 26.1 lb.in
Rated current / Rated cross section		125 A / 35 mm ²			Disconnect device Tool	Flat screwdriver Ø 5.5 mm Ø 0.217 in
Rated short-time withstand current (1s)		4200 A			Torque	0.5 - 0.8 N.m 4.4 - 7.1 lb.in
Rated voltage		400 V				
Impulse withstand voltage		6000 V				
Protection			NEMA			

The connecting capacity data for one Rigid: Solid/Stranded, or one Flexible conductor (when applicable) is a mandatory information required by IEC, UL and CSA standards (Copper conductors). All other data are provided as supplementary information only. For more details, please consult our CB, UL or CSA certificates and technical datasheet available on <http://www.TE.com>

CE	RoHS	PC	Gost R						
CE	RoHS								

Accessories

Description	Color	Type	Part Number	Pkg pce	Weight (1 pce) g
1 End stops	Dark grey ■	BAM4	1SNK900001R0000	50	14.00
		BAZ1	1SNK900002R0000	50	5.30
2 Locking devices	Blue ■	VRB3	1SNA128035R1600	10	
3 Clamps		SFB1	1SNA163860R0500	50	12.00
		SFB2	1SNA168956R0600	50	11.00
4 Busbars		BO3	1SNA164406R2400	1	
5 Terminal block markers	White ■	RC1010	1SNA238000R1600	1	1.30

Complete list of accessories is indicated in the terminal block datasheet. Some accessories such as jumper bars may modify the terminal block's ratings: complete information in the accessories catalogue pages.

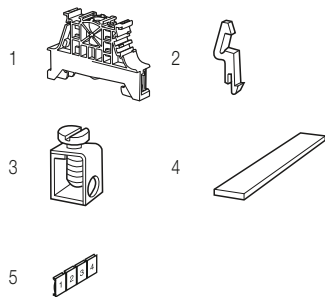

Technical data valid for copper conductors only.

D2.5/5.NTLP.L spring terminal blocks

Installation - 5 mm 0.197 in spacing



D2.5/5.NTLP.L

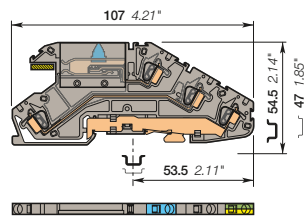

5 mm 0.197 in spacing

Description

- Specially developed for TN-C-S Network,
- Easy disconnection of neutral for isolation,
- Easy to access thanks to the front wiring entry,
- Clamping contact pressure non dependent on the operator and automatic creeping compensation,
- Save space with compact angled terminal blocks.

Ordering details

Description	Color	Type	Part Number	Pkg pce	Weight (1 pce) g
Installation Disconnect neutral with busbar connection + feed-through + ground circuits	Grey, blue, green-yellow	D2.5/5.NTLP.L	1SNA290322R0100	40	15.00

Main technical data

		IEC	UL	CSA	Mounting instructions	
1 conductor per clamp	Rigid: Solid/Stranded	0.14-4 mm ²	26-12 AWG		Rail	TH 35-7.5, TH 35-15
	Flexible without ferrule	0.14-2.5 mm ²			Wire stripping length	9.5 mm 0.37 in
	Flexible with non insulated ferrule				Tool	Flat screwdriver Ø 3.5 mm Ø 0.138 in
	Flexible with insulated ferrule	0.5-2.5 mm ²				
Gauge	A2					
Rated current / Rated cross section		20 A / 2.5 mm ²	20 A / 12 AWG			
Rated short-time withstand current (1s)		300 A				
Rated voltage		250 V	300 V			
Impulse withstand voltage		4000 V				
Protection		IP20	NEMA 1			

The connecting capacity data for one Rigid: Solid/Stranded, or one Flexible conductor (when applicable) is a mandatory information required by IEC, UL and CSA standards (Copper conductors). All other data are provided as supplementary information only. For more details, please consult our CB, UL or CSA certificates and technical datasheet available on <http://www.TE.com>



Accessories

Description	Color	Type	Part Number	Pkg pce	Weight (1 pce) g	
1 End stops	Dark grey	BAZ1	1SNK900002R0000	50	5.30	
		BAM4	1SNK900001R0000	50	14.00	
2 End sections	Grey	FED5.LA	1SNA291559R0400	20	5.50	
3 Jumper bars	Orange	2 poles 24 A	BJDL5-2	1SNA291102R2300	50	1.00
		3 poles	BJDL5-3	1SNA291103R2400	50	0.70
		4 poles	BJDL5-4	1SNA291104R2500	50	0.80
		5 poles	BJDL5-5	1SNA291105R2600	20	0.90
		10 poles	BJDL5-10	1SNA291110R2600	20	1.20
4 Clamps	Blue	0.5-35 mm ² 18-2 AWG	SFB1	1SNA163860R0500	50	12.00
		16-35 mm ² 6-2 AWG	SFB2	1SNA168956R0600	50	11.00
5 Distribution bar holders	Blue	SPBO.NTL	1SNA399886R2100	20	12.00	
6 Busbars		BO3	1SNA164406R2400	1		
7 Terminal block markers	White	RC55	1SNA230000R1200	1	2.90	

Complete list of accessories is indicated in the terminal block datasheet. Some accessories such as jumper bars may modify the terminal block's ratings: complete information in the accessories catalogue pages.

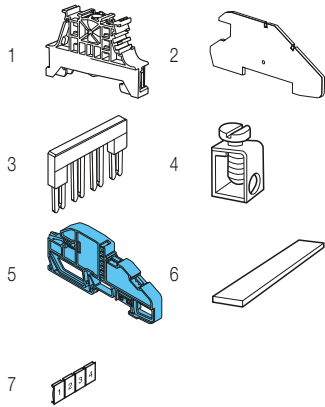

Installation spring terminal blocks

Description	Color	Type	Part Number	Pkg pce	Weight (1 pce) g
Installation 2 feed-through circuits	Grey	D2.5/5.LL.L	1SNA290328R1700	40	13.00

Technical data valid for copper conductors only.

D2.5/5.NLP.L spring terminal blocks

Installation - 5 mm 0.197 in spacing



D2.5/5.NLP.L

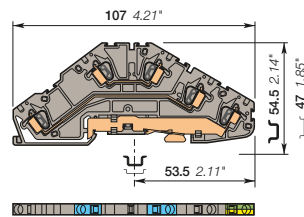

5 mm 0.197 in spacing

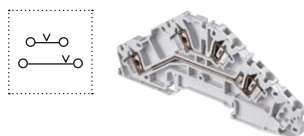
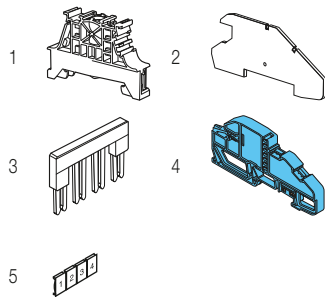

Description

- Specially developed for TN-C-S Network,
- Easy to access thanks to the front wiring entry,
- Clamping contact pressure non dependent on the operator and automatic creeping compensation,
- Save space with compact angled terminal blocks.

Ordering details

Description	Color	Type	Part Number	Pkg pce	Weight (1 pce) g
Installation Neutral + feed-through + ground circuits	Grey, blue, Green-yellow	D2.5/5.NLP.L	1SNA290324R0300	40	17.00

Main technical data

		IEC	UL	CSA
1 conductor per clamp	Rigid: Solid/Stranded	0.14-4 mm ²	26-12 AWG	
	Flexible without ferrule	0.14-2.5 mm ²		
	Flexible with non insulated ferrule			
	Flexible with insulated ferrule	0.5-2.5 mm ²		
	Gauge	A2		
Rated current / Rated cross section		24 A / 2.5 mm ²	20 A / 12 AWG	
Rated short-time withstand current (1s)		300 A		
Rated voltage		250 V	300 V	
Impulse withstand voltage		4000 V		
Protection		IP20	NEMA 1	

Mounting instructions

Rail		TH 35-7.5, TH 35-15
Wire stripping length		9.5 mm 0.37 in
Tool		Flat screwdriver Ø 3.5 mm Ø 0.138 in

The connecting capacity data for one Rigid: Solid/Stranded, or one Flexible conductor (when applicable) is a mandatory information required by IEC, UL and CSA standards (Copper conductors). All other data are provided as supplementary information only. For more details, please consult our CB, UL or CSA certificates and technical datasheet available on <http://www.TE.com>

RoHS	RoHS	UL	UL	CSA	CSA	RoHS	RoHS	UL	UL	CSA	CSA
------	------	----	----	-----	-----	------	------	----	----	-----	-----

Accessories

Description	Color	Type	Part Number	Pkg pce	Weight (1 pce) g	
1 End stops	Dark grey	BAZ1	1SNK900002R0000	50	5.30	
		BAM4	1SNK900001R0000	50	14.00	
2 End sections	Grey	FED5.L.B	1SNA291560R0100	20	5.50	
3 Jumper bars	Orange	2 poles	BJDL5-2	1SNA291102R2300	50	1.00
		3 poles	BJDL5-3	1SNA291103R2400	50	0.70
		4 poles	BJDL5-4	1SNA291104R2500	50	0.80
		5 poles	BJDL5-5	1SNA291105R2600	20	0.90
		10 poles	BJDL5-10	1SNA291110R2600	20	1.20
		4 Distribution bar holders	Blue	SPBO.NTL	1SNA399886R2100	20
5 Terminal block markers Blank card	White	RC55	1SNA230000R1200	1	2.90	

Complete list of accessories is indicated in the terminal block datasheet. Some accessories such as jumper bars may modify the terminal block's ratings: complete information in the accessories catalogue pages.

Installation spring terminal blocks

Description	Color	Type	Part Number	Pkg pce	Weight (1 pce) g
Installation 2 feed-through circuits	Grey	D2.5/5.LLL.L	1SNA290328R1700	40	13.00

Technical data valid for copper conductors only.

D2.5/5.NL.L spring terminal blocks

Installation - 5 mm 0.197 in spacing



1SNK16206R0014

D2.5/5.NL.L

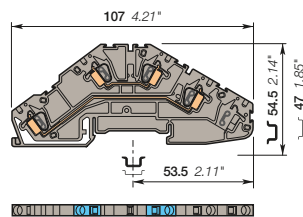

5 mm 0.197 in spacing

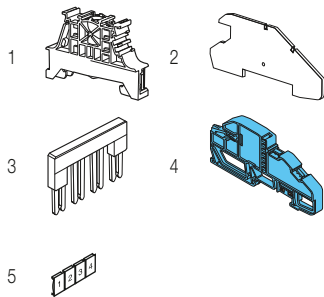

Description

- Specially developed for TN-C-S Network,
- Easy to access thanks to the front wiring entry,
- Clamping contact pressure non dependent on the operator and automatic creeping compensation,
- Save space with compact angled terminal blocks.

Ordering details

Description	Color	Type	Part Number	Pkg pce	Weight (1 pce) g
Installation Neutral + feed-through circuits	Grey, blue	D2.5/5.NL.L	1SNA290330R1500	40	13.00

Main technical data

		IEC	UL	CSA	Mounting instructions	
1 conductor per clamp	Rigid: Solid/Stranded	0.14-4 mm ²	26-12 AWG		Rail	TH 35-7.5, TH 35-15
	Flexible without ferrule	0.14-2.5 mm ²			Wire stripping length	9.5 mm 0.37 in
	Flexible with non insulated ferrule				Tool	Flat screwdriver Ø 3.5 mm Ø 0.138 in
	Flexible with insulated ferrule	0.5-2.5 mm ²				
Gauge		A2				
Rated current / Rated cross section		24 A / 2.5 mm ²	20 A / 12 AWG			
Rated short-time withstand current (1s)		300 A				
Rated voltage		400 V	300 V			
Impulse withstand voltage		6000 V				
Protection		IP20	NEMA 1			

The connecting capacity data for one Rigid: Solid/Stranded, or one Flexible conductor (when applicable) is a mandatory information required by IEC, UL and CSA standards (Copper conductors). All other data are provided as supplementary information only. For more details, please consult our CB, UL or CSA certificates and technical datasheet available on <http://www.TE.com>

RoHS	RoHS	USR CNR	Gost R			
------	------	---------	--------	--	--	--

Accessories

Description	Color	Type	Part Number	Pkg pce	Weight (1 pce) g	
1 End stops	Dark grey	BAZ1	1SNK900002R0000	50	5.30	
		BAM4	1SNK900001R0000	50	14.00	
2 End sections	Grey	FED5.L.B	1SNA291560R0100	20	5.50	
3 Jumper bars	Orange	2 poles 24 A	BJDL5-2	1SNA291102R2300	50	1.00
		3 poles	BJDL5-3	1SNA291103R2400	50	0.70
		4 poles	BJDL5-4	1SNA291104R2500	50	0.80
		5 poles	BJDL5-5	1SNA291105R2600	20	0.90
		10 poles	BJDL5-10	1SNA291110R2600	20	1.20
4 Distribution bar holders	Blue	SPBO.NTL	1SNA399886R2100	20	12.00	
5 Terminal block markers	White	RC55	1SNA230000R1200	1	2.90	

Complete list of accessories is indicated in the terminal block datasheet. Some accessories such as jumper bars may modify the terminal block's ratings: complete information in the accessories catalogue pages.

Installation spring terminal blocks

Description	Color	Type	Part Number	Pkg pce	Weight (1 pce) g
Installation 2 feed-through + ground circuits	Grey, green-yellow	D2.5/5.LLPL	1SNA290326R0500	40	17.00

Technical data valid for copper conductors only.

D2.5/5.LLP.L spring terminal blocks

Installation - 5 mm 0.197 in spacing



D2.5/5.LLP.L

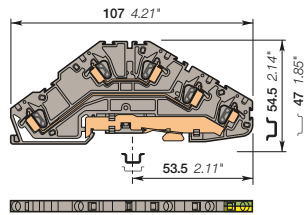

5 mm 0.197 in spacing

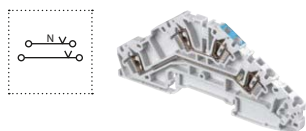
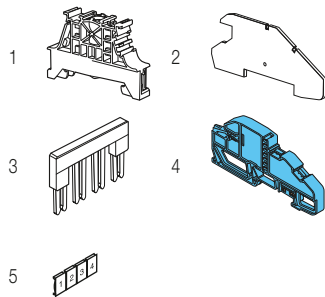

Description

- Specially developed for TN-C-S Network,
- Easy to access thanks to the front wiring entry,
- Clamping contact pressure non dependent on the operator and automatic creeping compensation,
- Save space with compact angled terminal blocks.

Ordering details

Description	Color	Type	Part Number	Pkg pce	Weight (1 pce) g
Installation	2 feed-through + ground circuits	Grey, Green-yellow	D2.5/5.LLP.L	1SNA290326R0500	40 17.00

Main technical data

		IEC	UL	CSA	Mounting instructions	
1 conductor per clamp	Rigid: Solid/Stranded	0.14-4 mm ²	26-12 AWG		Rail	TH 35-7.5, TH 35-15
	Flexible without ferrule	0.14-2.5 mm ²			Wire stripping length	9.5 mm 0.37 in
	Flexible with non insulated ferrule				Tool	Flat screwdriver Ø 3.5 mm Ø 0.138 in
	Flexible with insulated ferrule	0.5-2.5 mm ²				
	Gauge	A2				
Rated current / Rated cross section		24 A / 2.5 mm ²	20 A / 12 AWG			
Rated short-time withstand current (1s)		300 A				
Rated voltage		250 V	300 V			
Impulse withstand voltage		4000 V				
Protection		IP20	NEMA 1			

The connecting capacity data for one Rigid: Solid/Stranded, or one Flexible conductor (when applicable) is a mandatory information required by IEC, UL and CSA standards (Copper conductors). All other data are provided as supplementary information only. For more details, please consult our CB, UL or CSA certificates and technical datasheet available on <http://www.TE.com>

RoHS	RoHS	UL	UL	CSA	CSA	RoHS	RoHS	UL	UL	CSA	CSA
RoHS	RoHS	UL	UL	CSA	CSA	RoHS	RoHS	UL	UL	CSA	CSA

Accessories

Description	Color	Type	Part Number	Pkg pce	Weight (1 pce) g	
1 End stops	Dark grey	BAZ1	1SNC900002R0000	50	5.30	
		BAM4	1SNC900001R0000	50	14.00	
2 End sections	Grey	FED5.L.B	1SNA291560R0100	20	5.50	
3 Jumper bars	Orange	2 poles	BJDL5-2	1SNA291102R2300	50	1.00
		3 poles	BJDL5-3	1SNA291103R2400	50	0.70
		4 poles	BJDL5-4	1SNA291104R2500	50	0.80
		5 poles	BJDL5-5	1SNA291105R2600	20	0.90
		10 poles	BJDL5-10	1SNA291110R2600	20	1.20
4 Distribution bar holders	Blue	SPBO.NTL	1SNA399886R2100	20	12.00	
5 Terminal block markers	White	RC55	1SNA230000R1200	1	2.90	

Complete list of accessories is indicated in the terminal block datasheet. Some accessories such as jumper bars may modify the terminal block's ratings: complete information in the accessories catalogue pages.

Installation spring terminal blocks

Description	Color	Type	Part Number	Pkg pce	Weight (1 pce) g
Installation	Neutral + feed-through circuits	Grey, blue	D2.5/5.NLL	1SNA290330R1500	40 13.00

Technical data valid for copper conductors only.

D2.5/5.LL.L spring terminal blocks

Installation - 5 mm 0.197 in spacing



1SNC16209TF0014

D2.5/5.LL.L

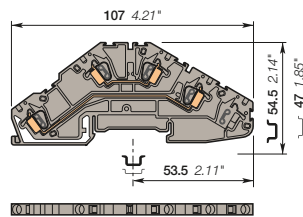

5 mm 0.197 in spacing

Description

- Specially developed for TN-C-S Network,
- Easy to access thanks to the front wiring entry,
- Clamping contact pressure non dependent on the operator and automatic creeping compensation,
- Save space with compact angled terminal blocks.

Ordering details

Description	Color	Type	Part Number	Pkg pce	Weight (1 pce) g
Installation 2 feed-through circuits	Grey <input type="checkbox"/>	D2.5/5.LL.L	1SNA290328R1700	40	13.00

Main technical data

		IEC	UL	CSA	Mounting instructions	
1 conductor per clamp	Rigid: Solid/Stranded	0.14-4 mm ²	26-12 AWG		Rail	TH 35-7.5, TH 35-15
	Flexible without ferrule	0.14-2.5 mm ²			Wire stripping length	9.5 mm 0.37 in
	Flexible with non insulated ferrule				Tool	Flat screwdriver Ø 3.5 mm Ø 0.138 in
	Flexible with insulated ferrule	0.5-2.5 mm ²				
Gauge		A2				
Rated current / Rated cross section		24 A / 2.5 mm ²	20 A / 12 AWG			
Rated short-time withstand current (1s)		300 A				
Rated voltage		400 V	300 V			
Impulse withstand voltage		6000 V				
Protection		IP20	NEMA 1			

The connecting capacity data for one Rigid: Solid/Stranded, or one Flexible conductor (when applicable) is a mandatory information required by IEC, UL and CSA standards (Copper conductors). All other data are provided as supplementary information only. For more details, please consult our CB, UL or CSA certificates and technical datasheet available on <http://www.TE.com>



Accessories

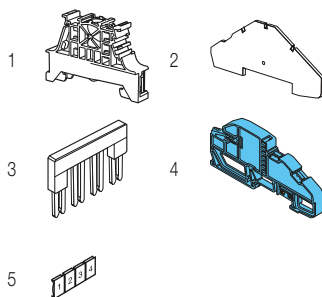

Description	Color	Type	Part Number	Pkg pce	Weight (1 pce) g	
1 End stops	Dark grey <input type="checkbox"/>	BAZ1	1SNC900002R0000	50	5.30	
		BAM4	1SNC900001R0000	50	14.00	
2 End sections	Grey <input type="checkbox"/>	FED5.L.B	1SNA291560R0100	20	4.75	
3 Jumper bars	Orange <input type="checkbox"/>	2 poles 24 A	BJDL5-2	1SNA291102R2300	50	1.00
		3 poles	BJDL5-3	1SNA291103R2400	50	0.70
		4 poles	BJDL5-4	1SNA291104R2500	50	0.80
		5 poles	BJDL5-5	1SNA291105R2600	20	0.90
		10 poles	BJDL5-10	1SNA291110R2600	20	1.20
4 Distribution bar holders	Blue <input type="checkbox"/>	SPBO.NT.L	1SNA399886R2100	20	12.00	
5 Terminal block markers	White <input type="checkbox"/>	RC55	1SNA230000R1200	1	2.90	

Complete list of accessories is indicated in the terminal block datasheet. Some accessories such as jumper bars may modify the terminal block's ratings: complete information in the accessories catalogue pages.

Technical data valid for copper conductors only.

Dedicated applications terminal blocks

Protection

Overview

238



Screw clamp technology

Ground + neutral

10 mm ²	M10/10.PE.N	239
16 mm ²	M16/12.PE.N	240
35 mm ²	M35/16.PE.N	241

Dedicated applications terminal blocks

Protection

Screw clamp technology



PEN



Feed-through

Section

IEC UL/CSA



Section	IEC	UL/CSA		
10 mm ²			M10/10.PE.N 20 mm 0.787 in	M10/10 10 mm 0.394 in
16 mm ²			M16/12.PE.N 24 mm 0.945 in	M16/12 12 mm 0.472 in
35 mm ²			M35/16.PE.N 32 mm 1.260 in	M35/16 16 mm 0.630 in

M10/10.PE.N screw clamp terminal blocks

Ground + neutral - 20 mm 0.787 in spacing

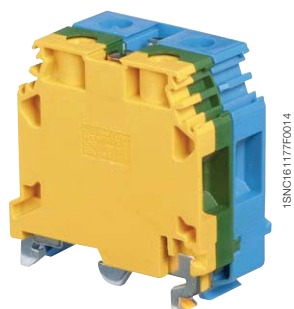

M10/10.PE.N

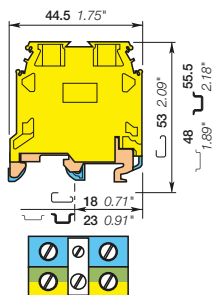

20 mm 0.787 in spacing

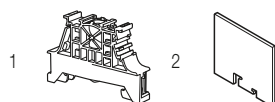

Description

- Simplify your PE.N connection with M10/10.P block connected to M10/10.N block through a pre-mounted jumper,
- Adapted to TNS and TNC-S electrical network.

Ordering details

Description	Color	Type	Part Number	Pkg pce	Weight (1 pce) g
Ground + neutral	Green-yellow, blue	M10/10.PE.N	1SNA165683R2200	20	53.00

Main technical data

		IEC	UL	CSA	Mounting instructions	
1 conductor per clamp	Rigid: Solid/Stranded	0.5-16 mm ²			Rail	G32, TH 35-7.5, TH 35-15
	Flexible without ferrule	0.5-10 mm ²			Wire stripping length	12 mm / 0.47 in
	Flexible with insulated ferrule				Screw clamp Tool	Flat screwdriver Ø 5.5 mm / Ø 0.22 in
	Gauge	B6			Torque	1.2 - 1.4 N.m / 10.6 - 12.3 lb.in
Rated cross section		10 mm ²			Rail connection screw Tool	Flat screwdriver Ø 4 mm / Ø 0.16 in
Rated short-time withstand current (1s)		1200 A			Torque	0.8 N.m / 7.1 lb.in

The connecting capacity data for one Rigid: Solid/Stranded, or one Flexible conductor (when applicable) is a mandatory information required by IEC, UL and CSA standards (Copper conductors). All other data are provided as supplementary information only. For more details, please consult our CB, UL or CSA certificates and technical datasheet available on <http://www.TE.com>

CE	RoHS	PC	Gost R						
CE	RoHS	PC	Gost R						

Accessories

Description	Color	Type	Part Number	Pkg pce	Weight (1 pce) g
1 End stops	Dark grey	BAM4	1SNK900001R0000	50	14.00
		BAZ1	1SNK900002R0000	50	5.30
2 Circuit separators	Grey	SCFEX1	1SNA103619R0400	10	30.00
		SCFEX3	1SNA103620R0100	10	30.00
		SCFM6	1SNA114825R0500	20	4.00

Complete list of accessories is indicated in the terminal block datasheet. Some accessories such as jumper bars may modify the terminal block's ratings: complete information in the accessories catalogue pages.

Technical data valid for copper conductors only.

M16/12.PE.N screw clamp terminal blocks

Ground + neutral - 24 mm 0.945 in spacing

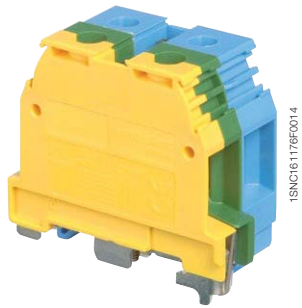
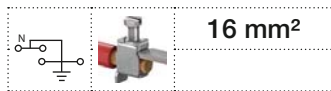

M16/12.PE.N

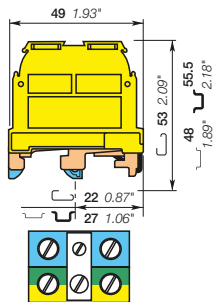

24 mm 0.945 in spacing

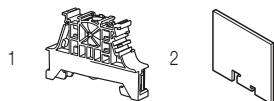

Description

- Simplify your PE.N connection with M16/12.P block connected to M16/12.N block through a pre-mounted jumper,
- Adapted to TNS and TNC-S electrical network.

Ordering details

Description	Color	Type	Part Number	Pkg pce	Weight (1 pce) g
Ground + neutral	Green-yellow, blue	M16/12.PE.N	1SNA165680R0300	20	68.00

Main technical data

		IEC	UL	CSA	Mounting instructions	
1 conductor per clamp	Rigid: Solid/Stranded	2.5-25 mm ²			Rail	G32, TH 35-7.5, TH 35-15
	Flexible without ferrule	2.5-16 mm ²			Wire stripping length	14 mm 0.55 in
	Flexible with insulated ferrule				Screw clamp Tool	Flat screwdriver Ø 5.5 mm Ø 0.22 in
	Gauge	B7			Torque	1.2 - 1.4 N.m 10.6 - 12.3 lb.in
Rated cross section		16 mm ²			Rail connection screw Tool	Flat screwdriver Ø 5.5 mm Ø 0.22 in
Rated short-time withstand current (1s)		1920 A			Torque	1 N.m 8.8 lb.in

The connecting capacity data for one Rigid: Solid/Stranded, or one Flexible conductor (when applicable) is a mandatory information required by IEC, UL and CSA standards (Copper conductors). All other data are provided as supplementary information only. For more details, please consult our CB, UL or CSA certificates and technical datasheet available on <http://www.TE.com>

CE	RoHS	Gost R				
CE	RoHS	Gost R				

Accessories

Description	Color	Type	Part Number	Pkg pce	Weight (1 pce) g
1 End stops	Dark grey	BAM4	1SNK900001R0000	50	14.00
		BAZ1	1SNK900002R0000	50	5.30
2 Circuit separators	Grey	SCFEX1	1SNA103619R0400	10	30.00
		SCFEX3	1SNA103620R0100	10	30.00
		SCFM6	1SNA114825R0500	20	4.00

Complete list of accessories is indicated in the terminal block datasheet. Some accessories such as jumper bars may modify the terminal block's ratings: complete information in the accessories catalogue pages.

Technical data valid for copper conductors only.

M35/16.PE.N screw clamp terminal blocks

Ground + neutral - 32 mm 1.260 in spacing

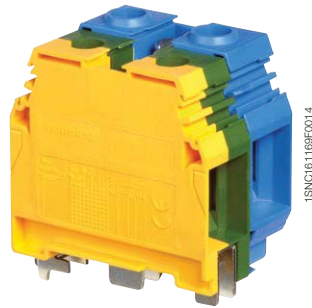

M35/16.PE.N

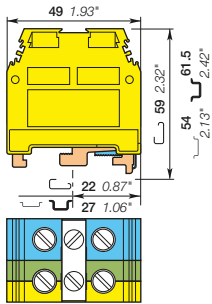

32 mm 1.260 in spacing

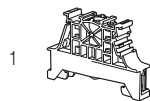

Description

- Simplify your PE.N connection with M35/16.P block connected to M35/16.N block through a pre-mounted jumper,
- Adapted to TNS and TNC-S electrical network.

Ordering details

Description	Color	Type	Part Number	Pkg pce	Weight (1 pce) g
Ground + neutral	Screw rail connection Green-yellow, blue	M35/16.PE.N	1SNA165575R2500	10	119.00

Main technical data

		IEC	UL	CSA	Mounting instructions	
1 conductor per clamp	Rigid: Solid/Stranded	6-50 mm ²			Rail	G32, TH 35-7.5, TH 35-15
	Flexible without ferrule	6-35 mm ²			Wire stripping length	17 mm 0.67 in
	Flexible with insulated ferrule				Screw clamp Tool	Flat screwdriver Ø 7 mm Ø 0.32 in
	Gauge	B9			Torque	2.8 - 3 N.m 24.6 - 26.1 lb.in
Rated cross section		35 mm ²			Rail connection screw Tool	Flat screwdriver Ø 5.5 mm Ø 0.22 in
Rated short-time withstand current (1s)		4200 A			Torque	1 N.m 8.8 lb.in

The connecting capacity data for one Rigid: Solid/Stranded, or one Flexible conductor (when applicable) is a mandatory information required by IEC, UL and CSA standards (Copper conductors). All other data are provided as supplementary information only. For more details, please consult our CB, UL or CSA certificates and technical datasheet available on <http://www.TE.com>

CE	RoHS	PC	Gost R						
CE	RoHS	PC	Gost R						

Accessories

Description	Color	Type	Part Number	Pkg pce	Weight (1 pce) g
1 End stops	10 mm 0.394 in	Dark grey	BAM4	50	14.00
	5.2 mm 0.205 in		BAZ1	50	5.30

Complete list of accessories is indicated in the terminal block datasheet. Some accessories such as jumper bars may modify the terminal block's ratings: complete information in the accessories catalogue pages.

Technical data valid for copper conductors only.



Dedicated applications terminal blocks

Disconnect



Overview

244

Screw clamp technology

Disconnect with pull lever

4 mm ² / 10 AWG	M4/6.D2.2S2	2 disconnect circuits	245
	M4/6.D2.2S2.T	2 disconnect circuits and test	246
	M4/6.D2.S1R	Change over type	247
	M4/6.D2.S1R.T	Change over type and test	248

Dedicated applications terminal blocks

Disconnect

Screw clamp technology



Disconnect with pull lever

Section

IEC UL/CSA

4 mm² 10 AWG



M4/6.D2.2S2
6 mm 0.236 in



M4/6.D2.2S2.T
6 mm 0.236 in



M4/6.D2.S1R
6 mm 0.236 in



M4/6.D2.S1R.T
6 mm 0.236 in

M4/6.D2.2S2 screw clamp terminal blocks

Disconnect with pull lever - with 2 independent circuits - 6 mm 0.236 in spacing

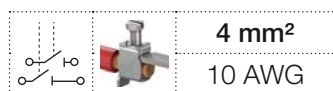

4 mm²
10 AWG

Description

- Save space with double deck terminal blocks: 2 independent disconnect circuits in just 6 mm 0.236 in spacing,
- Black pull lever controls upper deck contact and grey pull lever controls lower deck contact,
- Closed terminal block: no end section needed.

Ordering details

Description	Color	Type	Part Number	Pkg pce	Weight (1 pce) g
Disconnect With 2 independent circuits	Grey, black	M4/6.D2.2S2	1SNA199444R2500	25	30.00

Main technical data

		IEC	UL	CSA	Mounting instructions	
1 conductor per clamp	Rigid: Solid/Stranded	0.2-4 mm ²		24-10 AWG	Rail	G32, TH 35-7.5, TH 35-15
	Flexible without ferrule	0.2-4 mm ²			Wire stripping length	9.5 mm 0.374 in
	Flexible with insulated ferrule				Tool	Flat screwdriver Ø 4 mm Ø 0.157 in
	Gauge	A4			Torque	0.5 - 0.8 Nm 4.4 - 7.1 lb.in
Rated current / Rated cross section		12 A / 1 mm ²		10 A / 10 AWG		
Rated short-time withstand current (1s)		120 A				
Rated voltage		500 V		300 V		
Impulse withstand voltage		6000 V				
Protection		IP20	NEMA 1			

The connecting capacity data for one Rigid: Solid/Stranded, or one Flexible conductor (when applicable) is a mandatory information required by IEC, UL and CSA standards (Copper conductors). All other data are provided as supplementary information only. For more details, please consult our CB, UL or CSA certificates and technical datasheet available on <http://www.TE.com>

CE	RoHS	CSAus	Gost R
----	------	-------	--------



M4/6.D2.2S2

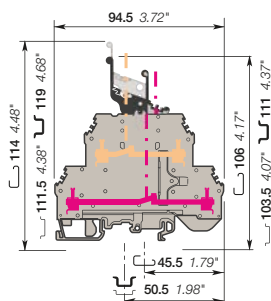

6 mm 0.236 in spacing

Notes

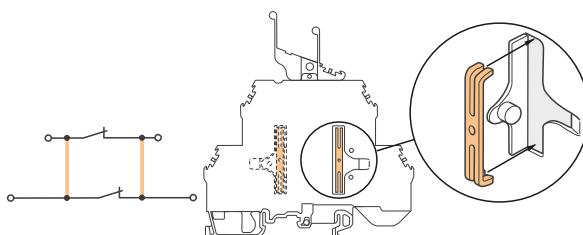

Mounting of the vertical jumper bar between decks (ITVE2)
Interconnection between decks is possible on each side of the switch, using accessory ITVE2.
Trap door opens with a screwdriver.

Accessories

Description	Color	Type	Part Number	Pkg pce	Weight (1 pce) g
1 End stops 10 mm 0.394 in	Dark grey	BAZH1	1SNK900102R0000	20	24.00
2 Jumper bars 1 poles 24 A	Grey	AD2.5	1SNA114205R2000	50	1.60
3 Lateral jumper bars 2 poles 35 A	Grey	PC6-2	1SNA113546R1400	10	2.00
		PC6-3	1SNA116536R0500	10	2.00
		PC6-4	1SNA116537R0600	10	3.00
		PC6-10	1SNA113548R2600	10	8.00
4 Insulating tips For lateral jumper bars type PC...		EIP	1SNA113550R2400	10	
5 Shield connectors		CBD2S	1SNA178408R1400	50	
6 Inner deck jumper bars		ITVE2	1SNA179825R2600	20	1.30
7 Terminal block markers Blank card	White	RC610	1SNA233000R0100	1	7.50

Complete list of accessories is indicated in the terminal block datasheet.
Some accessories such as jumper bars may modify the terminal block's ratings: complete information in the accessories catalogue pages.

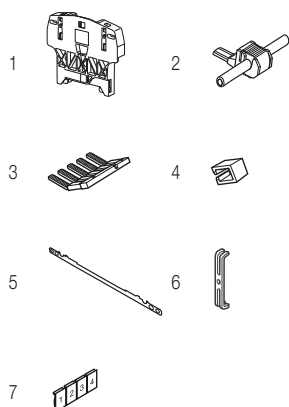

Technical data valid for copper conductors only.

M4/6.D2.2S2 screw clamp terminal blocks

Disconnect with pull lever with 2 independent circuits and 4 test sockets - 6 mm 0.236 in spacing

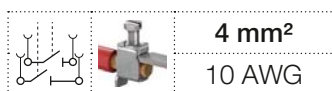

M4/6.D2.2S2

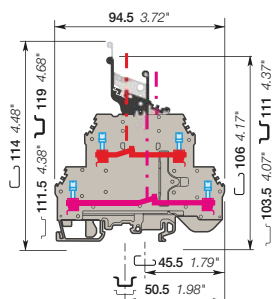

6 mm 0.236 in spacing

Description

- Save space with double deck terminal blocks: 2 independent disconnect circuits in just 6 mm 0.236 in spacing,
- Black pull lever controls upper deck contact and grey pull lever controls lower deck contact,
- Ease your test operations with the 2 built-in test sockets,
- Closed terminal block: no end section needed.

Ordering details

Description	Color	Type	Part Number	Pkg pce	Weight (1 pce) g
Disconnect With 2 independent circuits and 4 test sockets DIA 2 mm 0.079 in	Grey, black	M4/6.D2.2S2.T	1SNA199448R0100	25	30.00

Main technical data

	IEC	UL	CSA	Mounting instructions
1 conductor per clamp	Rigid: Solid/Stranded Flexible without ferrule Flexible with insulated ferrule Gauge A4	0.2-4 mm ² 0.2-4 mm ² A4	24-10 AWG	Rail G32, TH 35-7.5, TH 35-15 Wire stripping length 9.5 mm 0.374 in Tool Flat screwdriver Ø 4 mm Ø 0.157 in
Rated current / Rated cross section	12 A / 1 mm ²		10 A / 10 AWG	Torque 0.5 - 0.6 Nm 4.4 - 5.3 lb.in
Rated short-time withstand current (1s)	120 A			
Rated voltage	500 V		300 V	
Impulse withstand voltage	6000 V			
Protection	IP20	NEMA 1		

The connecting capacity data for one Rigid: Solid/Stranded Flexible conductor (when applicable) is a mandatory information required by IEC, UL and CSA standards (Copper conductors). All other data are provided as supplementary information only. For more details, please consult our CB, UL or CSA certificates and technical datasheet available on <http://www.TE.com>

CE	RoHS	cCSAus	Gost R
----	------	--------	--------

Notes

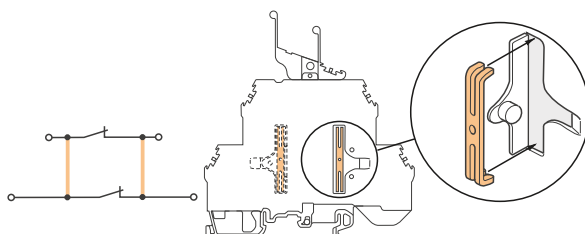

Mounting of the vertical jumper bar between decks (ITVE2)

Interconnection between decks is possible on each side of the switch, using accessory ITVE2.

Trap door opens with a screwdriver.

Accessories

Description	Color	Type	Part Number	Pkg pce	Weight (1 pce) g
1 End stops 10 mm 0.394 in	Dark grey	BAZH1	1SNK900102R0000	20	24.00
2 Jumper bars 1 poles 24 A	Grey	AD2.5	1SNA114205R2000	50	1.60
3 Lateral jumper bars 2 poles 35 A	Grey	PC6-2	1SNA113546R1400	10	2.00
3 poles		PC6-3	1SNA116536R0500	10	2.00
4 poles		PC6-4	1SNA116537R0600	10	3.00
10 poles		PC6-10	1SNA113548R2600	10	8.00
4 Insulating tips For lateral jumper bars type PC...		EIP	1SNA113550R2400	10	
5 Test plugs DIA 2 mm 0.079 in	Black	FC2	1SNA007865R2600	100	
6 Shield connectors		CBD2S	1SNA178408R1400	50	
7 Inner deck jumper bars		ITVE2	1SNA179825R2600	20	1.30
8 Terminal block markers Blank card	White	RC610	1SNA233000R0100	1	7.50

Complete list of accessories is indicated in the terminal block datasheet.

Some accessories such as jumper bars may modify the terminal block's ratings: complete information in the accessories catalogue pages.

Technical data valid for copper conductors only.

M4/6.D2.S1R screw clamp terminal blocks

Disconnect with pull lever - change over type - 6 mm 0.236 in spacing

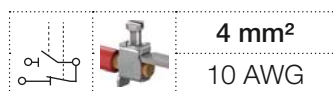

1SNIC161337FC014

M4/6.D2.S1R

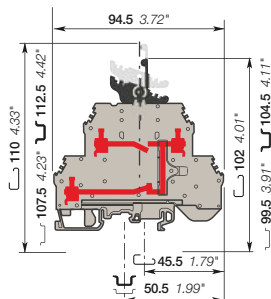

6 mm 0.236 in spacing

Description

- Direct a signal either to the upper deck (contact control pull lever in high position), or to the lower deck (pull lever in low position) with just one operation,
- Closed terminal block: no end section needed.

Ordering details

Description	Color	Type	Part Number	Pkg pce	Weight (1 pce) g
Disconnect Change over type	Grey, black	M4/6.D2.S1R	1SNA199452R2500	25	30.00

Main technical data

		IEC	UL	CSA
1 conductor per clamp	Rigid: Solid/Stranded	0.2-4 mm ²		24-10 AWG
	Flexible without ferrule	0.2-4 mm ²		
	Flexible with insulated ferrule			
	Gauge	A4		
Rated current / Rated cross section		12 A / 1 mm ²		10 A / 10 AWG
Rated short-time withstand current (1s)		120 A		
Rated voltage		500 V		300 V
Impulse withstand voltage		6000 V		
Protection		IP20	NEMA 1	

Mounting instructions

Rail		G32, TH 35-7.5, TH 35-15
Wire stripping length		9.5 mm 0.374 in
Tool		Flat screwdriver Ø 4 mm Ø 0.157 in
Torque		0.5 - 0.8 Nm 4.4 - 7.1 lb.in

The connecting capacity data for one Rigid: Solid/Stranded, or one Flexible conductor (when applicable) is a mandatory information required by IEC, UL and CSA standards (Copper conductors). All other data are provided as supplementary information only. For more details, please consult our CB, UL or CSA certificates and technical datasheet available on <http://www.TE.com>

CE	RoHS	CSAus	Gost R
CE	RoHS	cCSAus	Gost R

Accessories

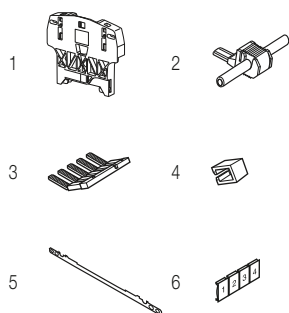

Description	Color	Type	Part Number	Pkg pce	Weight (1 pce) g
1 End stops 10 mm 0.394 in	Dark grey	BAZH1	1SNK900102R0000	20	24.00
2 Jumper bars 1 poles 24 A	Grey	AD2.5	1SNA114205R2000	50	1.60
3 Lateral jumper bars 2 poles 35 A	Grey	PC6-2	1SNA113546R1400	10	2.00
		PC6-3	1SNA116536R0500	10	2.00
		PC6-4	1SNA116537R0600	10	3.00
		PC6-10	1SNA113548R2600	10	8.00
4 Insulating tips For lateral jumper bars type PC...		EIP	1SNA113550R2400	10	
5 Shield connectors		CBD2S	1SNA178408R1400	50	
6 Terminal block markers Blank card	White	RC610	1SNA233000R0100	1	7.50

Complete list of accessories is indicated in the terminal block datasheet. Some accessories such as jumper bars may modify the terminal block's ratings: complete information in the accessories catalogue pages.

Technical data valid for copper conductors only.

M4/6.D2.S1R screw clamp terminal blocks

Disconnect with pull lever - change over type with 3 test sockets 6 mm 0.236 in spacing

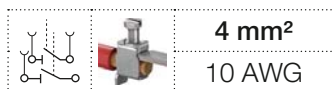

M4/6.D2.S1R

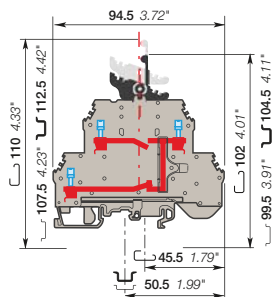

6 mm 0.236 in spacing

Description

- Direct a signal either to the upper deck (contact control pull lever in high position), or to the lower deck (pull lever in low position) with just one operation,
- Ease your test operations with the built-in test sockets,
- Closed terminal block: no end section needed.

Ordering details

Description	Color	Type	Part Number	Pkg pce	Weight (1 pce) g
Disconnect Change over type with 3 test sockets DIA 2 mm 0.079 in	Grey, black	M4/6.D2.S1R.T	1SNA199456R2100	25	30.00

Main technical data

	IEC	UL	CSA
1 conductor per clamp			
Rigid: Solid/Stranded	0.2-4 mm ²		24-10 AWG
Flexible without ferrule	0.2-4 mm ²		
Flexible with insulated ferrule			
Gauge	A4		
Rated current / Rated cross section	12 A / 1 mm ²		10 A / 10 AWG
Rated short-time withstand current (1s)	120 A		
Rated voltage	500 V		300 V
Impulse withstand voltage	6000 V		
Protection	IP20	NEMA 1	

Mounting instructions

Rail		G32, TH 35-7.5, TH 35-15
Wire stripping length		9.5 mm 0.374 in
Tool		Flat screwdriver Ø 4 mm Ø 0.157 in
Torque		0.5 - 0.6 Nm 4.4 - 5.3 lb.in

The connecting capacity data for one Rigid: Solid/Stranded, or one Flexible conductor (when applicable) is a mandatory information required by IEC, UL and CSA standards (Copper conductors). All other data are provided as supplementary information only. For more details, please consult our CB, UL or CSA certificates and technical datasheet available on <http://www.TE.com>

CE	RoHS	cCSAus	Gost R
----	------	--------	--------

Accessories

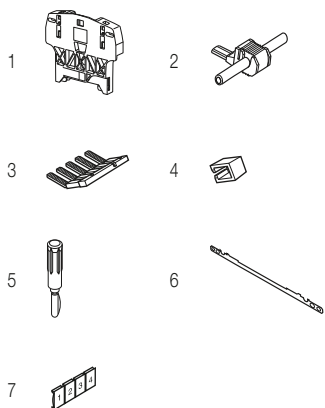

Description	Color	Type	Part Number	Pkg pce	Weight (1 pce) g
1 End stops 10 mm 0.394 in	Dark grey	BAZH1	1SNK900102R0000	20	24.00
2 Jumper bars 1 poles 24 A	Grey	AD2.5	1SNA114205R2000	50	1.60
3 Lateral jumper bars 2 poles 35 A	Grey	PC6-2	1SNA113546R1400	10	2.00
		PC6-3	1SNA116536R0500	10	2.00
		PC6-4	1SNA116537R0600	10	3.00
		PC6-10	1SNA113548R2600	10	8.00
4 Insulating tips For lateral jumper bars type PC...		EIP	1SNA113550R2400	10	
5 Test plugs DIA 2 mm 0.079 in	Black	FC2	1SNA007865R2600	100	
6 Shield connectors		CBD2S	1SNA178408R1400	50	
7 Terminal block markers Blank card	White	RC610	1SNA233000R0100	1	7.50

Complete list of accessories is indicated in the terminal block datasheet. Some accessories such as jumper bars may modify the terminal block's ratings: complete information in the accessories catalogue pages.

Technical data valid for copper conductors only.





Dedicated applications terminal blocks

Component holder



Overview

252

Screw clamp technology

Component holder

4 mm² / 12 AWG

M4/6.DE1.D	With 2 diodes	253
M4/6.DE1.D1	With 2 diodes	254
M4/6.DE2.D	With 2 diodes	255
M4/6.DD	With 1 diode	256
M4/6.DD1	With 1 diode	257
M4/6.DE	Open circuit	258
M4/6.DE1	Open circuit	259
M4/6.DE2	Open circuit	260

For 5 x 20 mm and 5 x 25 mm fuses

4 mm² / 12 AWG

D4/8.D2.P.SF	261
D4/8.D2.P.SFL	262
D4/8.D2.P.SFD	262

ADO - ADO technology

Component holder

1.5 mm²

D1.5/6.ADO.D1	With diode	263
----------------------	------------	-----

Dedicated applications terminal blocks

Component holder

Screw clamp technology



Component holder

Section											
IEC	UL/CSA										
4 mm ²	12 AWG	M4/6.DE1.D	M4/6.DE1.D1	M4/6.DE2.D	M4/6.DD	M4/6.DD1	M4/6.DE	M4/6.DE1	M4/6.DE2		
		6 mm 0.236 in	6 mm 0.236 in	6 mm 0.236 in	6 mm 0.236 in	6 mm 0.236 in	6 mm 0.236 in	6 mm 0.236 in	6 mm 0.236 in	6 mm 0.236 in	6 mm 0.236 in



For 5 x 20 mm
and 5 x 25 mm fuses

Section					
IEC	UL/CSA				
4 mm ²	12 AWG	D4/8.D2.PSF	D4/8.D2.PSFL	D4/8.D2.PSFD	
		8 mm 0.315 in	8 mm 0.315 in	8 mm 0.315 in	

ADO-ADO technology



Component holder

Section		
IEC	UL/CSA	
1.5 mm ²		D1.5/6.ADO.D1
		6 mm 0.236 in

M4/6.DE screw clamp terminal blocks

Component holder - 6 mm 0.236 in spacing



4 mm²

Description

Ease the test operation with two 1N4007 diodes.

Ordering details

Description	Color	Type	Part Number	Pkg pce	Weight (1 pce) g
Component holder With two 1N4007 diodes, common on cathode (1000V peak-250V Service-1A)	Grey <input type="checkbox"/>	M4/6.DE1.D	1SNA115371R2600	50	16.00

Main technical data

		IEC	UL	CSA	Mounting instructions	
1 conductor per clamp	Rigid: Solid/Stranded	0.5-4 mm ²			Rail	G32, TH 35-7.5, TH 35-15
	Flexible without ferrule	0.5-4 mm ²			Wire stripping length	8.5 mm 0.33 in
	Flexible with insulated ferrule				Tool	Flat screwdriver Ø 4 mm Ø 0.157 in
	Gauge	A4			Torque	0.5 - 0.6 Nm 4.4 - 5.3 lb.in
Rated current / Rated cross section		20 A / 4 mm ²				
Rated short-time withstand current (1s)		480 A				
Rated voltage		500 V				
Impulse withstand voltage						
Protection		IP20	NEMA 1			

The connecting capacity data for one Rigid: Solid/Stranded, or one Flexible conductor (when applicable) is a mandatory information required by IEC, UL and CSA standards (Copper conductors). All other data are provided as supplementary information only. For more details, please consult our CB, UL or CSA certificates and technical datasheet available on <http://www.TE.com>

--	--	--	--	--	--	--	--	--	--



1SNC161219F0014

M4/6.DE

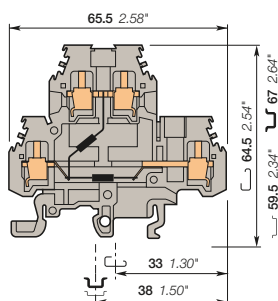

6 mm 0.236 in spacing

Accessories

Description	Color	Type	Part Number	Pkg pce	Weight (1 pce) g	
1 End stops 10 mm 0.394 in	Dark grey <input type="checkbox"/>	BAZH1	1SNK900102R0000	20	24.00	
2 End sections 1 mm 0.039 in	Grey <input type="checkbox"/>	FEM6D	1SNA118499R2300	20	2.70	
3 Jumper bars		2 poles 32 A	BJM6D-2	1SNA179668R2000	10	4.00
		3 poles	BJM6D-3	1SNA179669R2100	10	6.00
		4 poles	BJM6D-4	1SNA179670R2600	10	8.00
		5 poles	BJM6D-5	1SNA179671R1300	10	10.00
		10 poles	BJM6D-10	1SNA179672R1400	10	20.00
4 Lateral jumper bars 10 poles 35 A		PC61-10	1SNA16331R2200	10	5.00	
5 Cross spacing jumpers 5 mm 0.200 in - 6 mm 0.236 in - 8 mm 0.315 in		EL6	1SNA173627R2100	10	0.10	
6 Terminal block markers Blank card	White <input type="checkbox"/>	RC610	1SNA233000R0100	1	7.50	

Complete list of accessories is indicated in the terminal block datasheet.

Some accessories such as jumper bars may modify the terminal block's ratings: complete information in the accessories catalogue pages.

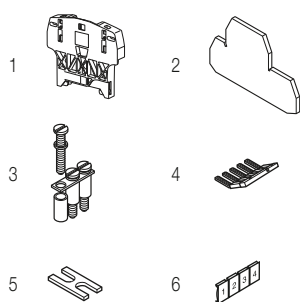

Technical data valid for copper conductors only.

M4/6.DE screw clamp terminal blocks

Component holder - 6 mm 0.236 in spacing

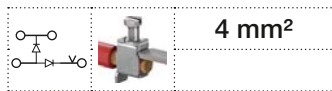

4 mm²



M4/6.DE

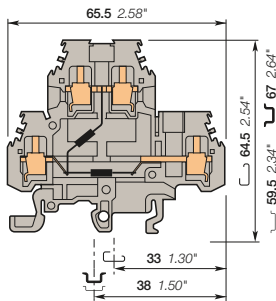

6 mm 0.236 in spacing

Description

Ease the test operation with two 1N4007 diodes.

Ordering details

Description	Color	Type	Part Number	Pkg pce	Weight (1 pce) g
Component holder With two 1N4007 diodes, common on anode (1000V peak-250V Service-1A)	Grey <input type="checkbox"/>	M4/6.DE1.D1	1SNA115591R0400	50	16.00

Main technical data

		IEC	UL	CSA	Mounting instructions	
1 conductor per clamp	Rigid: Solid/Stranded	0.5-4 mm ²			Rail	G32, TH 35-7.5, TH 35-15
	Flexible without ferrule	0.5-4 mm ²			Wire stripping length	8.5 mm 0.33 in
	Flexible with insulated ferrule				Tool	Flat screwdriver Ø 4 mm Ø 0.157 in
	Gauge	A4			Torque	0.5 - 0.6 Nm 4.4 - 5.3 lb.in
Rated current / Rated cross section		20 A / 4 mm ²				
Rated short-time withstand current (1s)		480 A				
Rated voltage		500 V				
Impulse withstand voltage						
Protection		IP20	NEMA 1			

The connecting capacity data for one Rigid: Solid/Stranded, or one Flexible conductor (when applicable) is a mandatory information required by IEC, UL and CSA standards (Copper conductors). All other data are provided as supplementary information only. For more details, please consult our CB, UL or CSA certificates and technical datasheet available on <http://www.TE.com>

--	--	--	--	--	--	--

Accessories

Description	Color	Type	Part Number	Pkg pce	Weight (1 pce) g
1 End stops 10 mm 0.394 in	Dark grey <input type="checkbox"/>	BAZH1	1SNK900102R0000	20	24.00
2 End sections 1 mm 0.039 in	Grey <input type="checkbox"/>	FEM6D	1SNA118499R2300	20	2.70
3 Jumper bars 2 poles 32 A		BJMI6D-2	1SNA179668R2000	10	4.00
		BJMI6D-3	1SNA179669R2100	10	6.00
		BJMI6D-4	1SNA179670R2600	10	8.00
		BJMI6D-5	1SNA179671R1300	10	10.00
		BJMI6D-10	1SNA179672R1400	10	20.00
4 Lateral jumper bars 10 poles 35 A		PC61-10	1SNA163311R2200	10	5.00
5 Cross spacing jumpers 5 mm 0.200 in - 6 mm 0.236 in - 8 mm 0.315 in		EL6	1SNA173627R2100	10	0.10
6 Terminal block markers Blank card	White <input type="checkbox"/>	RC610	1SNA233000R0100	1	7.50

Complete list of accessories is indicated in the terminal block datasheet.

Some accessories such as jumper bars may modify the terminal block's ratings: complete information in the accessories catalogue pages.

Technical data valid for copper conductors only.

M4/6.DE screw clamp terminal blocks

Component holder - 6 mm 0.236 in spacing



4 mm²

Description

Ease the test operation with two 1N4007 diodes.

Ordering details

Description	Color	Type	Part Number	Pkg pce	Weight (1 pce) g
Component holder With two 1N4007 diodes, common on cathode (1000V peak-250V Service-1A)	Grey <input type="checkbox"/>	M4/6.DE2.D	1SNA115327R1200	50	20.00

Main technical data

		IEC	UL	CSA	Mounting instructions	
1 conductor per clamp	Rigid: Solid/Stranded	0.5-4 mm ²			Rail	G32, TH 35-7.5, TH 35-15
	Flexible without ferrule	0.5-4 mm ²			Wire stripping length	8.5 mm 0.33 in
	Flexible with insulated ferrule				Tool	Flat screwdriver Ø 4 mm Ø 0.157 in
	Gauge	A4			Torque	0.5 - 0.6 Nm 4.4 - 5.3 lb.in
Rated current / Rated cross section		20 A / 4 mm ²				
Rated short-time withstand current (1s)		480 A				
Rated voltage		500 V				
Impulse withstand voltage						
Protection		IP20	NEMA 1			

The connecting capacity data for one Rigid: Solid/Stranded, or one Flexible conductor (when applicable) is a mandatory information required by IEC, UL and CSA standards (Copper conductors). All other data are provided as supplementary information only. For more details, please consult our CB, UL or CSA certificates and technical datasheet available on <http://www.TE.com>

--	--	--	--	--	--	--	--	--	--



M4/6.DE

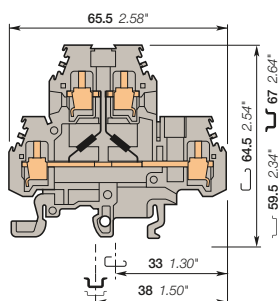

6 mm 0.236 in spacing

Accessories

Description	Color	Type	Part Number	Pkg pce	Weight (1 pce) g	
1 End stops 10 mm 0.394 in	Dark grey <input type="checkbox"/>	BAZH1	1SNK900102R0000	20	24.00	
2 End sections 1 mm 0.039 in	Grey <input type="checkbox"/>	FEM6D	1SNA118499R2300	20	2.70	
3 Jumper bars		2 poles 32 A	BJM6D-2	1SNA179668R2000	10	4.00
		3 poles	BJM6D-3	1SNA179669R2100	10	6.00
		4 poles	BJM6D-4	1SNA179670R2600	10	8.00
		5 poles	BJM6D-5	1SNA179671R1300	10	10.00
		10 poles	BJM6D-10	1SNA179672R1400	10	20.00
4 Lateral jumper bars 10 poles 35 A		PC61-10	1SNA163311R2200	10	5.00	
5 Cross spacing jumpers 5 mm 0.200 in - 6 mm 0.236 in - 8 mm 0.315 in		EL6	1SNA173627R2100	10	0.10	
6 Terminal block markers Blank card	White <input type="checkbox"/>	RC610	1SNA233000R0100	1	7.50	

Complete list of accessories is indicated in the terminal block datasheet.

Some accessories such as jumper bars may modify the terminal block's ratings: complete information in the accessories catalogue pages.

Technical data valid for copper conductors only.

M4/6.DD screw clamp terminal blocks

Component holder - 6 mm 0.236 in spacing

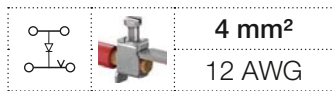

M4/6.DD

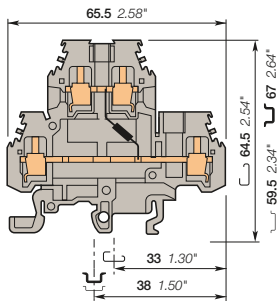

6 mm 0.236 in spacing

Description

Protect or test your circuit with one 1N4007 diodes.

Ordering details

Description	Color	Type	Part Number	Pkg	Weight
Component holder	Cathode of the blocking diode connected to the lower circuit	Grey <input type="checkbox"/> M4/6.DD	1SNA115168R2300	pce 50	(1 pce) g 20.00

Main technical data

	IEC	UL	CSA	Mounting instructions
1 conductor per clamp	Rigid: Solid/Stranded Flexible without ferrule Flexible with insulated ferrule Gauge	0.2-4 mm ² 0.22-4 mm ²	22-12 AWG	18-12 AWG
				Rail G32, TH 35-7.5, TH 35-15
				Wire stripping length 8.5 mm 0.33 in
				Tool Flat screwdriver Ø 4 mm Ø 0.157 in
Rated current / Rated cross section	20 A / 4 mm ²	25 A / 12 AWG	25 A / 12 AWG	
Rated short-time withstand current (1s)	480 A			
Rated voltage	500 V	600 V	150 V	
Impulse withstand voltage				
Protection	IP20	NEMA 1		

The connecting capacity data for one Rigid: Solid/Stranded, or one Flexible conductor (when applicable) is a mandatory information required by IEC, UL and CSA standards (Copper conductors). All other data are provided as supplementary information only. For more details, please consult our CB, UL or CSA certificates and technical datasheet available on <http://www.TE.com>

CE	RoHS	USF	CSA	Gost R
----	------	-----	-----	--------

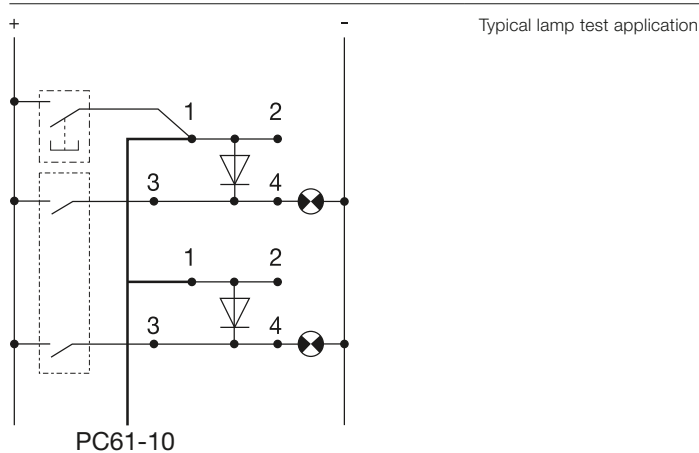

Accessories

Description	Color	Type	Part Number	Pkg	Weight
1 End stops 10 mm 0.394 in	Dark grey <input type="checkbox"/>	BAZH1	1SNK900102R0000	20	24.00
2 End sections 1 mm 0.039 in	Grey <input type="checkbox"/>	FEM6D	1SNA118499R2300	20	2.70
3 Jumper bars					
3 poles		BJMI6D-2	1SNA179668R2000	10	4.00
4 poles		BJMI6D-3	1SNA179669R2100	10	6.00
5 poles		BJMI6D-4	1SNA179670R2600	10	8.00
10 poles		BJMI6D-5	1SNA179671R1300	10	10.00
4 Lateral jumper bars 10 poles 35 A		BJMI6D-10	1SNA179672R1400	10	20.00
5 Cross spacing jumpers 5 mm 0.200 in - 6 mm 0.236 in - 8 mm 0.315 in		PC61-10	1SNA163311R2200	10	5.00
6 Terminal block markers Blank card	White <input type="checkbox"/>	EL6	1SNA173627R2100	10	0.10
		RC610	1SNA233000R0100	1	7.50

Complete list of accessories is indicated in the terminal block datasheet.

Some accessories such as jumper bars may modify the terminal block's ratings: complete information in the accessories catalogue pages.

Technical data valid for copper conductors only.

M4/6.DD screw clamp terminal blocks

Component holder - 6 mm 0.236 in spacing

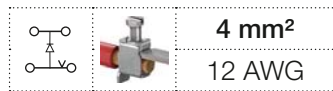

Description

Protect or test your circuit with one 1N4007 diodes.

Ordering details

Description	Color	Type	Part Number	Pkg pce	Weight (1 pce) g
Component holder	Grey <input type="checkbox"/>	M4/6.DD1	1SNA115184R0400	50	20.00



M4/6.DD

Main technical data

		IEC	UL	CSA	Mounting instructions	
1 conductor per clamp	Rigid: Solid/Stranded	0.2-4 mm ²	22-12 AWG	18-12 AWG	Rail	G32, TH 35-7.5, TH 35-15
	Flexible without ferrule	0.22-4 mm ²			Wire stripping length	8.5 mm 0.33 in
	Flexible with insulated ferrule				Tool	Flat screwdriver Ø 4 mm Ø 0.157 in
	Gauge				Torque	0.5 - 0.6 Nm 4.4 - 5.3 lb.in
Rated current / Rated cross section		20 A / 4 mm ²	25 A / 12 AWG	25 A / 12 AWG		
Rated short-time withstand current (1s)		480 A				
Rated voltage		500 V	600 V	150 V		
Impulse withstand voltage						
Protection		IP20	NEMA 1			

The connecting capacity data for one Rigid: Solid/Stranded, or one Flexible conductor (when applicable) is a mandatory information required by IEC, UL and CSA standards (Copper conductors). All other data are provided as supplementary information only. For more details, please consult our CB, UL or CSA certificates and technical datasheet available on <http://www.TE.com>

--	--	--	--	--

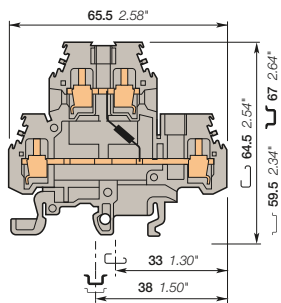

6 mm 0.236 in spacing

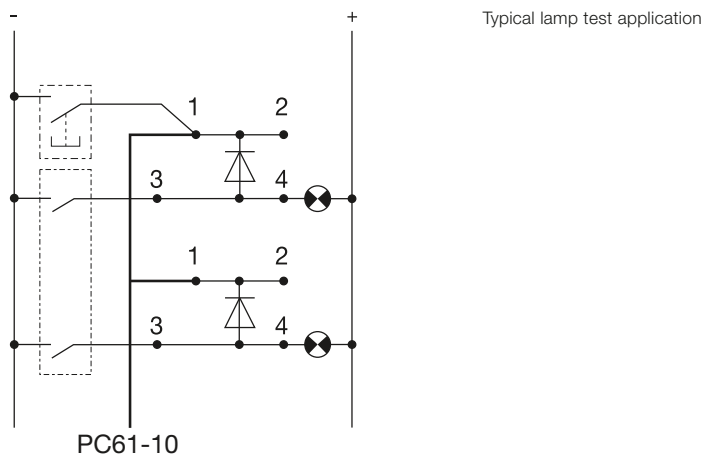

Accessories

Description	Color	Type	Part Number	Pkg pce	Weight (1 pce) g
1 End stops 10 mm 0.394 in	Dark grey <input type="checkbox"/>	BAZH1	1SNK900102R0000	20	24.00
2 End sections 1 mm 0.039 in	Grey <input type="checkbox"/>	FEM6D	1SNA118499R2300	20	2.70
3 Jumper bars 2 poles 32 A		BJM6D-2	1SNA179668R2000	10	4.00
		BJM6D-3	1SNA179669R2100	10	6.00
		BJM6D-4	1SNA179670R2600	10	8.00
		BJM6D-5	1SNA179671R1300	10	10.00
		BJM6D-10	1SNA179672R1400	10	20.00
4 Lateral jumper bars 10 poles 35 A		PC61-10	1SNA163311R2200	10	5.00
5 Cross spacing jumpers 5 mm 0.200 in - 6 mm 0.236 in - 8 mm 0.315 in		EL6	1SNA173627R2100	10	0.10
6 Terminal block markers Blank card	White <input type="checkbox"/>	RC610	1SNA233000R0100	1	7.50

Complete list of accessories is indicated in the terminal block datasheet.

Some accessories such as jumper bars may modify the terminal block's ratings: complete information in the accessories catalogue pages.

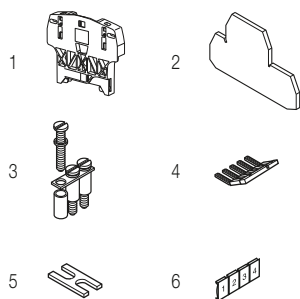

Technical data valid for copper conductors only.

M4/6.DE screw clamp terminal blocks

Component holder - 6 mm 0.236 in spacing

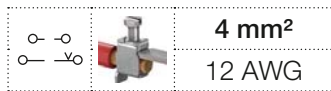

M4/6.DE

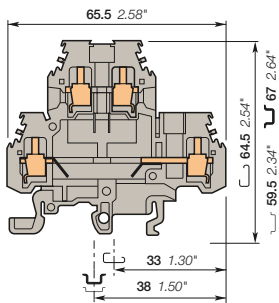

6 mm 0.236 in spacing

Description

Customize yourself the double deck terminal blocks by soldering electronic components (thickness 5 mm 0.200 in max).

Ordering details

Description	Color	Type	Part Number	Pkg pce	Weight (1 pce) g
Component holder Upper and lower circuit opened	Grey <input type="checkbox"/>	M4/6.DE	1SNA115185R0500	50	20.00

Main technical data

	IEC	UL	CSA
1 conductor per clamp	Rigid: Solid/Stranded	0.5-4 mm ²	22-12 AWG
	Flexible without ferrule	0.5-4 mm ²	
	Flexible with insulated ferrule		
	Gauge	A4	
Rated current / Rated cross section	26 A / 4 mm ²	20 A / 12 AWG	20 A / 12 AWG
Rated short-time withstand current (1s)	480 A		
Rated voltage	500 V	600 V	300 V
Impulse withstand voltage			
Protection	IP20	NEMA 1	

Mounting instructions

Rail		G32, TH 35-7.5, TH 35-15
Wire stripping length		8.5 mm 0.33 in
Tool		Flat screwdriver Ø 4 mm Ø 0.157 in
Torque		0.5 - 0.6 Nm 4.4 - 5.3 lb.in

The connecting capacity data for one Rigid: Solid/Stranded, or one Flexible conductor (when applicable) is a mandatory information required by IEC, UL and CSA standards (Copper conductors). All other data are provided as supplementary information only. For more details, please consult our CB, UL or CSA certificates and technical datasheet available on <http://www.TE.com>

--	--	--	--	--

Accessories

Description	Color	Type	Part Number	Pkg pce	Weight (1 pce) g
1 End stops 10 mm 0.394 in	Dark grey <input type="checkbox"/>	BAZH1	1SNK900102R0000	20	24.00
2 End sections 1 mm 0.039 in	Grey <input type="checkbox"/>	FEM6D	1SNA118499R2300	20	2.70
3 Jumper bars 2 poles 32 A		BJMI6D-2	1SNA179668R2000	10	4.00
		BJMI6D-3	1SNA179669R2100	10	6.00
		BJMI6D-4	1SNA179670R2600	10	8.00
		BJMI6D-5	1SNA179671R1300	10	10.00
		BJMI6D-10	1SNA179672R1400	10	20.00
4 Lateral jumper bars 10 poles 35 A		PC61-10	1SNA163311R2200	10	5.00
5 Cross spacing jumpers 5 mm 0.200 in - 6 mm 0.236 in - 8 mm 0.315 in		EL6	1SNA173627R2100	10	0.10
6 Terminal block markers Blank card	White <input type="checkbox"/>	RC610	1SNA233000R0100	1	7.50

Complete list of accessories is indicated in the terminal block datasheet. Some accessories such as jumper bars may modify the terminal block's ratings: complete information in the accessories catalogue pages.

Technical data valid for copper conductors only.

M4/6.DE screw clamp terminal blocks

Component holder - 6 mm 0.236 in spacing

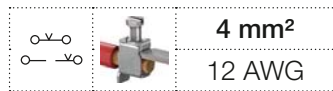

M4/6.DE

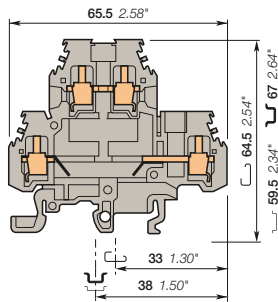

6 mm 0.236 in spacing

Description

Customize yourself the double deck terminal blocks by soldering electronic components (thickness 5 mm 0.200 in max).

Ordering details

Description	Color	Type	Part Number	Pkg pce	Weight (1 pce) g
Component holder Lower circuit opened	Grey <input type="checkbox"/>	M4/6.DE1	1SNA115177R1400	50	20.00

Main technical data

		IEC	UL	CSA
1 conductor per clamp	Rigid: Solid/Stranded	0.5-4 mm ²	22-12 AWG	22-12 AWG
	Flexible without ferrule	0.5-4 mm ²		
	Flexible with insulated ferrule			
	Gauge	A4		
Rated current / Rated cross section		26 A / 4 mm ²	20 A / 12 AWG	20 A / 12 AWG
Rated short-time withstand current (1s)		480 A		
Rated voltage		500 V	600 V	300 V
Impulse withstand voltage				
Protection		IP20	NEMA 1	

Mounting instructions

Rail		G32, TH 35-7.5, TH 35-15
Wire stripping length		8.5 mm 0.33 in
Tool		Flat screwdriver Ø 4 mm Ø 0.157 in
Torque		0.5 - 0.6 Nm 4.4 - 5.3 lb.in

The connecting capacity data for one Rigid: Solid/Stranded, or one Flexible conductor (when applicable) is a mandatory information required by IEC, UL and CSA standards (Copper conductors). All other data are provided as supplementary information only. For more details, please consult our CB, UL or CSA certificates and technical datasheet available on <http://www.TE.com>

CE	RoHS	USR	CSA	Gost R

Accessories

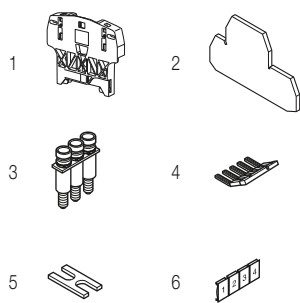

Description	Color	Type	Part Number	Pkg pce	Weight (1 pce) g
1 End stops 10 mm 0.394 in	Dark grey <input type="checkbox"/>	BAZH1	1SNK900102R0000	20	24.00
2 End sections 1 mm 0.039 in	Grey <input type="checkbox"/>	FEM6D	1SNA118499R2300	20	2.70
3 Jumper bars 6 mm 32 A		BJM6D-2	1SNA179668R2000	10	4.00
		BJM6D-3	1SNA179669R2100	10	6.00
		BJM6D-4	1SNA179670R2600	10	8.00
		BJM6D-5	1SNA179671R1300	10	10.00
		BJM6D-10	1SNA179672R1400	10	20.00
4 Lateral jumper bars 10 poles 35 A		PC61-10	1SNA163311R2200	10	5.00
5 Cross spacing jumpers 5 mm 0.200 in - 6 mm 0.236 in - 8 mm 0.315 in		EL6	1SNA173627R2100	10	0.10
6 Terminal block markers Blank card	White <input type="checkbox"/>	RC610	1SNA233000R0100	1	7.50

Complete list of accessories is indicated in the terminal block datasheet.

Some accessories such as jumper bars may modify the terminal block's ratings: complete information in the accessories catalogue pages.

Technical data valid for copper conductors only.

M4/6.DE screw clamp terminal blocks

Component holder - 6 mm 0.236 in spacing

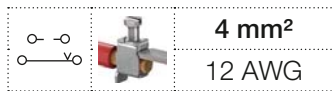

M4/6.DE

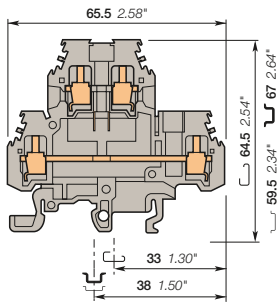

6 mm 0.236 in spacing

Description

Customize yourself the double deck terminal blocks by soldering electronic components (thickness 5 mm 0.200 in max).

Ordering details

Description	Color	Type	Part Number	Pkg pce	Weight (1 pce) g
Component holder Upper circuit opened	Grey <input type="checkbox"/>	M4/6.DE2	1SNA115326R1100	50	20.00

Main technical data

		IEC	UL	CSA	Mounting instructions	
1 conductor per clamp	Rigid: Solid/Stranded	0.5-4 mm ²		22-12 AWG	Rail	G32, TH 35-7.5, TH 35-15
	Flexible without ferrule	0.5-4 mm ²			Wire stripping length	8.5 mm / 0.33 in
	Flexible with insulated ferrule				Tool	Flat screwdriver Ø 4 mm Ø 0.157 in
	Gauge	A4			Torque	0.5 - 0.6 Nm 4.4 - 5.3 lb.in
Rated current / Rated cross section		26 A / 4 mm ²		20 A / 12 AWG		
Rated short-time withstand current (1s)		480 A				
Rated voltage		500 V		300 V		
Impulse withstand voltage						
Protection		IP20		NEMA 1		

The connecting capacity data for one Rigid: Solid/Stranded, or one Flexible conductor (when applicable) is a mandatory information required by IEC, UL and CSA standards (Copper conductors). All other data are provided as supplementary information only. For more details, please consult our CB, UL or CSA certificates and technical datasheet available on <http://www.TE.com>

CE	RoHS	CSA	Gost R			

Accessories

Description	Color	Type	Part Number	Pkg pce	Weight (1 pce) g
1 End stops 10 mm 0.394 in	Dark grey <input checked="" type="checkbox"/>	BAZH1	1SNK900102R0000	20	24.00
2 End sections 1 mm 0.039 in	Grey <input type="checkbox"/>	FEM6D	1SNA118499R2300	20	2.70
3 Jumper bars 2 poles 32 A		BJMI6D-2	1SNA179668R2000	10	4.00
		BJMI6D-3	1SNA179669R2100	10	6.00
		BJMI6D-4	1SNA179670R2600	10	8.00
		BJMI6D-5	1SNA179671R1300	10	10.00
		BJMI6D-10	1SNA179672R1400	10	20.00
4 Lateral jumper bars 10 poles 35 A		PC61-10	1SNA163311R2200	10	5.00
5 Cross spacing jumpers 5 mm 0.200 in - 6 mm 0.236 in - 8 mm 0.315 in		EL6	1SNA173627R2100	10	0.10
6 Terminal block markers Blank card	White <input type="checkbox"/>	RC610	1SNA233000R0100	1	7.50

Complete list of accessories is indicated in the terminal block datasheet. Some accessories such as jumper bars may modify the terminal block's ratings: complete information in the accessories catalogue pages.

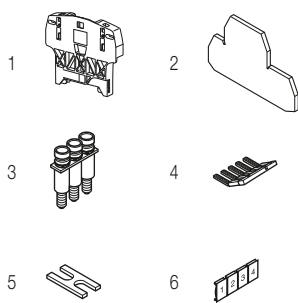

Technical data valid for copper conductors only.

D4/8.D2.P.SF screw clamp terminal blocks

For 5 x 20 and 5 x 25 fuses - 8 mm 0.315 in spacing

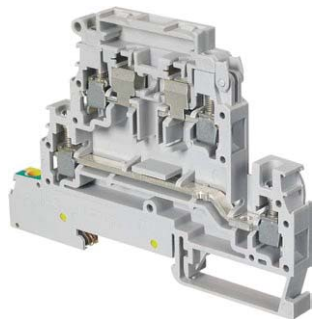
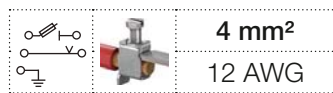

D4/8.D2.P.SF

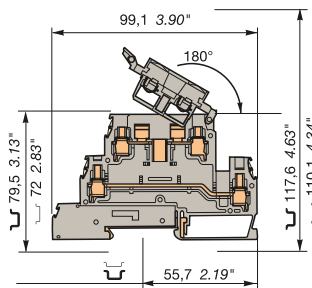

8 mm 0.315 in spacing

Description

- Protect your circuits with 5x20 and 5x25 fuse terminal blocks (fuse not supplied with terminal blocks),
- Save space with double deck terminal blocks: 2 independent circuits 1 fuse on upper deck + 1 feed-through + 1 ground.

Ordering details

Description	Color	Type	Part Number	Pkg qty	Weight (1 pce) g
Fuse	Grey <input type="checkbox"/>	D4/8.D2.P.SF	1SNA400270R2000	25	35.00

Main technical data

Connecting capacity		IEC	UL	CSA
1 conductor per clamp	Rigid: Solid/Stranded	0.5-6 mm ²	20-12 AWG	20-12 AWG
	Flexible without ferrule	0.5-4 mm ²		
	Flexible with insulated ferrule			
	Gauge	A4		
Rated current / Rated cross section		6.3 A / 4 mm ²	6.3 A / 12 AWG	6.3 A / 12 AWG
Rated short-time withstand current (1s)				
Rated voltage		300 V	300 V	300 V
Impulse withstand voltage		6000 V		
Protection		IP20	NEMA 1	

Mounting instructions

Rail		TH 35-7.5, TH 35-15
Wire stripping length		9.5 mm 0.37 in
Tool		Flat screwdriver Ø 4 mm Ø 0.157 in
Torque		0.5 - 0.8 N.m 4.4 - 7.1 lb.in

The connecting capacity data for one Rigid: Solid/Stranded, or one Flexible conductor (when applicable) is a mandatory information required by IEC, UL and CSA standards (Copper conductors). All other data are provided as supplementary information only. For more details, please consult our CB, UL or CSA certificates and technical datasheet available on <http://www.TE.com>

CE	RoHS	UR	CSA	Gost R

Accessories

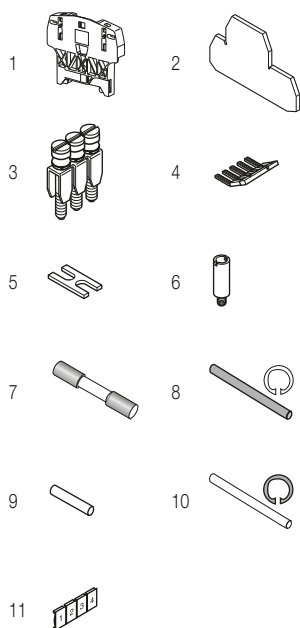

Description	Color	Type	Part Number	Pkg qty	Weight (1 pce) g
1 End stops	Dark grey <input type="checkbox"/>	BAZH1	1SNK900102R0000	20	24.00
2 End sections	Grey <input type="checkbox"/>	FEM8D2S1	1SNA400273R1700	20	4.60
3 Jumper bars		BJM8	1SNA168520R0500	10	5.00
3 poles			1SNA168521R2200	10	7.00
4 poles			1SNA168522R2300	10	9.50
10 poles			1SNA168974R0000	10	23.70
4 Lateral jumper bars		PC81-10	1SNA173523R1100	10	5.00
5 Cross spacing jumpers		EL6	1SNA173627R2100	10	0.10
6 Test sockets		AL2	1SNA163043R2100	50	0.90
DIA 4 mm 0.157 in		AL4-M3	1SNA206721R0100	50	1.10
7 Fuses		FU520	1SNA008288R1500	10	
1 A			1SNA008290R1300	10	
2 A			1SNA008291R0000	10	
8 Assembly rods		TGA8	1SNA168672R1100	10	1.00
3 poles			1SNA168673R1200	10	
4 poles			1SNA168674R1300	10	
9 Neutral cartridges		CN5	1SNA179371R1600	10	3.90
10 Spring retaining rings		ANT	1SNA168675R1400	10	
11 Terminal block markers	White <input type="checkbox"/>	RC810	1SNA234000R0200	1	8.20

Complete list of accessories is indicated in the terminal block datasheet.

Some accessories such as jumper bars may modify the terminal block's ratings: complete information in the accessories catalogue pages.

Technical data valid for copper conductors only.

D4/8.D2.P.SF screw clamp terminal blocks

For 5 x 20 and 5 x 25 fuses - with blown fuse indicator - 8 mm 0.315 in spacing

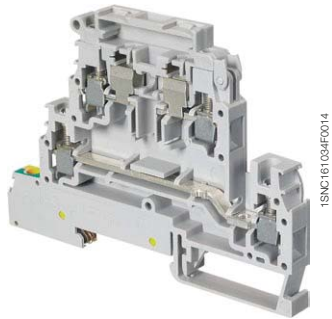
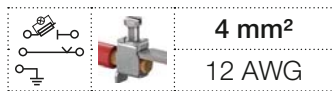

D4/8.D2.P.SF

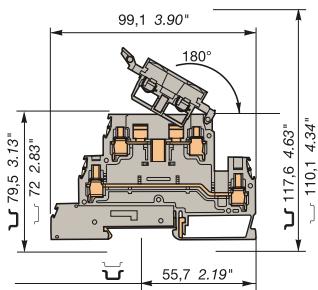

8 mm 0.315 in spacing

Description

- Protect your circuits with 5x20 and 5x25 fuse terminal blocks (fuse not supplied with terminal blocks),
- Save space with double deck terminal blocks: 2 independent circuits 1 fuse on upper deck + 1 feed-through + 1 ground,
- Quickly identify the defective circuit thanks to the blown fuse indicator.

Ordering details

Description	Color	Type	Part Number	Pkg qty	Weight (1 pce) g
Fuse With blown fuse indicator by neon 110-230 V AC	Grey <input type="checkbox"/>	D4/8.D2.P.SFL	1SNA400271R1500	25	35.00
With blown fuse indicator by LED 24-60 V DC / 110 V AC	Grey <input type="checkbox"/>	D4/8.D2.P.SFD	1SNA400272R1600	25	35.00

Main technical data

Connecting capacity	IEC	UL	CSA	Mounting instructions	
1 conductor per clamp	Rigid: Solid/Stranded Flexible without ferrule Flexible with insulated ferrule Gauge	0.5-6 mm² 0.5-4 mm² A4	20-12 AWG	20-12 AWG	Rail Wire stripping length Tool Torque
Rated current / Rated cross section	6.3 A / 4 mm²	6.3 A / 12 AWG	6.3 A / 12 AWG	TH 35-7.5, TH 35-15	9.5 mm 0.37 in
Rated short-time withstand current (1s)				Flat screwdriver Ø 4 mm Ø 0.157 in	
Rated voltage	300 V	300 V	300 V		0.5 - 0.8 N.m 4.4 - 7.1 lb.in
Impulse withstand voltage	6000 V				
Protection	IP20	NEMA 1			

The connecting capacity data for one Rigid: Solid/Stranded, or one Flexible conductor (when applicable) is a mandatory information required by IEC, UL and CSA standards (Copper conductors). All other data are provided as supplementary information only. For more details, please consult our CB, UL or CSA certificates and technical datasheet available on <http://www.TE.com>

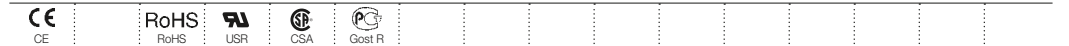

Notes

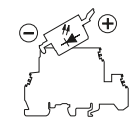

Blocks with LED indicator are labeled "+" on the outside of the lever. The indicator can be reversed in the field if required.
Leakage current D4/8.D2.P.SFL : 110 V : < 0.5 mA / 230 V : < 0.7 mA
Leakage current D4/8.D2.P.SFD : 24 V : < 0.5 mA / 110 V : < 2.2 mA

Accessories

Description	Color	Type	Part Number	Pkg qty	Weight (1 pce) g
1 End stops	Grey <input type="checkbox"/>	BAZH1	1SNK900102R0000	50	24.00
2 End sections	Grey <input type="checkbox"/>	FEM8D2S1	1SNA400273R1700	20	4.60
3 Jumper bars		BJM8	1SNA168520R0500	10	5.00
			1SNA168521R2200	10	7.00
			1SNA168522R2300	10	9.50
			1SNA168974R0000	10	23.70
4 Lateral jumper bars		PC81-10	1SNA173523R1100	10	5.00
5 Cross spacing jumpers		EL6	1SNA173627R2100	10	0.10
6 Test sockets		AL2	1SNA163043R2100	50	0.90
		AL4-M3	1SNA206721R0100	50	1.10
7 Fuses		FU520	1SNA008288R1500	10	
			1SNA008290R1300	10	
			1SNA008291R0000	10	
8 Assembly rods		TGA8	1SNA168672R1100	10	1.00
			1SNA168673R1200	10	
			1SNA168674R1300	10	
9 Neutral cartridges		CN5	1SNA179371R1600	10	3.90
10 Spring retaining rings		ANT	1SNA168675R1400	10	
11 Terminal block markers	White <input type="checkbox"/>	RC810	1SNA234000R0200	1	8.20

Complete list of accessories is indicated in the terminal block datasheet.

Some accessories such as jumper bars may modify the terminal block's ratings: complete information in the accessories catalogue pages.

Technical data valid for copper conductors only.

D1.5/6.ADO.D IDC terminal blocks

Component holder ADO - ADO - 6 mm 0.236 in spacing



1.5 mm²



1SN1C163062S02014

D1.5/6.ADO.D

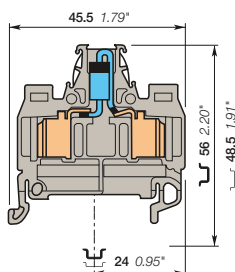

6 mm 0.236 in spacing

Description

- Terminal blocks with built-in 1N5408 diode,
- With the TE Connectivity ADO System®, experience the fastest and most reliable connection on the market,
- Designed for control applications exposed to severe constraints (vibrations, shocks, corrosion etc.),
- Up to 2 wires per connection.

Ordering details

Description	Color	Type	Part Number	Pkg pce	Weight (1 pce) g
Component holder With diode (cathode on the right)	Grey <input type="checkbox"/>	D1.5/6.ADO.D1	1SNA199248R1000	50	7.00

Main technical data

		IEC	UL	CSA	
ADO	Rigid: Solid/Stranded Flexible without ferrule	0.34-1.5 mm ² 0.34-1.5 mm ²			Rail
Screw clamp	Rigid: Solid/Stranded Flexible without ferrule Flexible with insulated ferrule Gauge				Wire stripping length
Rated current / Rated cross section		1 A / 1.5 mm ²			Tool
Rated short-time withstand current (1s)		180 A			Torque
Rated voltage		80 V			
Impulse withstand voltage					
Protection		IP20	NEMA 1		

Mounting instructions

The connecting capacity data for one Rigid: Solid/Stranded, or one Flexible conductor (when applicable) is a mandatory information required by IEC, UL and CSA standards (Copper conductors). All other data are provided as supplementary information only. For more details, please consult our CB, UL or CSA certificates and technical datasheet available on <http://www.TE.com>

RoHS	Gost R
<input type="checkbox"/>	<input type="checkbox"/>

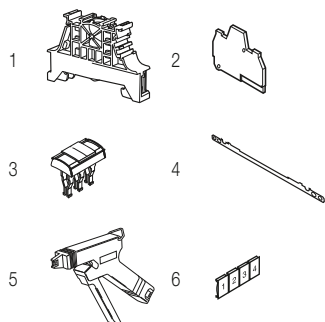

Accessories

Description	Color	Type	Part Number	Pkg pce	Weight (1 pce) g
1 End stops	Dark grey <input type="checkbox"/>	BAM4	1SNK900001R0000	50	14.00
		BAZ1	1SNK900002R0000	50	5.30
2 End sections	Grey <input type="checkbox"/>	FEMAD3	1SNA199341R0500	20	2.50
3 Jumper bars	Orange <input type="checkbox"/>	BJADO6-2	1SNA205974R0600	20	1.00
		BJADO6-3	1SNA205975R0700	20	1.00
		BJADO6-10	1SNA205982R2700	10	6.00
4 Shield connectors		CBM5	1SNA178745R1400	50	
5 Tools		OUPAD	1SNA178944R0400	1	205.00
		OUMAD	1SNA179466R0600	1	29.00
6 Terminal block markers	White <input type="checkbox"/>	RC610	1SNA233000R0100	1	7.50

Complete list of accessories is indicated in the terminal block datasheet.

Some accessories such as jumper bars may modify the terminal block's ratings: complete information in the accessories catalogue pages.

Technical data valid for copper conductors only.



Index

Part number classification

Order code	Type	Page	Order code	Type	Page	Order code	Type	Page
1SNA007865R2600	FC2	19	1SNA115141R1000	M26.F	92	1SNA116987R0200	FEMR8	63
1SNA008288R1500	FU520	34	1SNA115142R1100	M31.AF	89	1SNA116991R0600	FEMR8T	67
1SNA008289R1600	FU520	34	1SNA115143R1200	M31.FF	85	1SNA117318R2300	FEDR5	115
1SNA008290R1300	FU520	34	1SNA115144R1300	M31.F	93	1SNA117600R0300	FEDR61	117
1SNA008291R0000	FU520	34	1SNA115145R1400	M35.AF	90	1SNA117668R0200	FEDR51	120
1SNA008292R0100	FU520	34	1SNA115146R1500	M35.FF	86	1SNA118368R1600	FEM6	66
1SNA094302R2100	CPFT2	176	1SNA115147R1600	M35.F	94	1SNA118499R2300	FEM6D	253
1SNA094303R2200	CPFT3	176	1SNA115148R2700	M42.AF	91	1SNA118707R0300	SCF6	66
1SNA094304R2300	CPFT4	176	1SNA115149R2000	M42.FF	87	1SNA120251R0700	DR6.N	117
1SNA094310R2400	CPFT10	176	1SNA115150R2500	M42.F	95	1SNA120491R1100	DR6.1.N	118
1SNA094352R2200	CPFTR-2	176	1SNA115168R2300	M6.DD	256	1SNA125117R0200	M6.NT	227
1SNA094353R2300	CPFTR-3	176	1SNA115177R1400	M6.DE1	259	1SNA125119R1400	M8.NT	228
1SNA094354R2400	CPFTR-4	176	1SNA115184R0400	M6.DD1	257	1SNA125121R0600	M10.NT	229
1SNA094360R0600	CPFTR-10	176	1SNA115185R0500	M6.DE	258	1SNA125358R0300	M16.NT	231
1SNA103189R2600	SCD	214	1SNA115201R2500	M9.EE	101	1SNA125487R0600	MA2.5.NT	226
1SNA103588R2600	SCFT1	167	1SNA115206R2200	MT6	197	1SNA125593R0000	M12.NT1	230
1SNA103619R0400	SCFEX1	239	1SNA115229R2000	M6.SNTS	66	1SNA125711R1500	MA2.5-2CPE	178
1SNA103620R0100	SCFEX3	112	1SNA115236R1700	M8.ST	157	1SNA125930R1500	M6.N.RS	63
1SNA103672R0100	SCF9	101	1SNA115237R1000	M8.ST1	158	1SNA125961R1000	MA2.5.D2-2CPE	180
1SNA105028R2100	DCB	182	1SNA115239R2200	M8.ST3	160	1SNA128035R1600	VRB3	226
1SNA105141R2700	M8.STP	168	1SNA115243R2600	M8.ST7	157	1SNA128361R0100	VRB6	230
1SNA105142R2000	M8.STP	168	1SNA115262R2100	M12.FF	102	1SNA146227R2500	MT6.Ex	197
1SNA105265R0300	MS6	112	1SNA115263R2200	M12.FF	102	1SNA160496R2600	DR6.P	117
1SNA107239R0300	FC2.MC	53	1SNA115265R2400	MS6	112	1SNA163043R2100	AL2	63
1SNA110106R2500	DR1.4	114	1SNA115277R2000	M8.STP	168	1SNA163155R2600	REH3	105
1SNA110251R0500	DR6	117	1SNA115278R0100	MS8	113	1SNA163181R1100	PT101	65
1SNA110264R0200	D6.LNTP1	217	1SNA115313R1400	M6.ST.Sn	165	1SNA163311R2200	PC61-10	31
1SNA110269R1700	D6.LNTP3	218	1SNA115314R1500	M6.ST.Au	165	1SNA163313R2400	PC8-10	20
1SNA110327R2100	D6.LNTP2	219	1SNA115320R2700	M10.RS	65	1SNA163315R2600	PC10-10	166
1SNA110328R0200	D6.LNTP4	221	1SNA115326R1100	M6.DE2	260	1SNA163394R2600	VSJ11	65
1SNA110331R2500	D6.LNTP6	223	1SNA115327R1200	M6.DE2.D	255	1SNA163403R2000	CPP263	84
1SNA110332R2600	D6.LNTP7	222	1SNA115359R0200	M8.STA	162	1SNA163409R0600	CPP313	85
1SNA110333R2700	D6.LNTP8	220	1SNA115371R2600	M6.DE1.D	253	1SNA163418R2600	CPP353	86
1SNA110368R1200	DR8.SF	121	1SNA115500R2500	M8.STP3	167	1SNA163424R1400	CPP423	87
1SNA110415R1200	D6.A.NTLP	224	1SNA115510R1600	DR1.5	115	1SNA163860R0500	SFB1	213
1SNA110418R2500	D6.A.LLP	225	1SNA115511R0300	M12.FF	102	1SNA164406R2400	BO3	213
1SNA110439R2200	D6.NTLP	213	1SNA115529R1500	M8.STP1	167	1SNA164581R1300	BJS8	68
1SNA110440R0700	D6.NLP	214	1SNA115537R0500	D2.6.DL	195	1SNA164582R1400	BJS8	68
1SNA110441R2400	D6.LLP	215	1SNA115539R1700	M10.ST.Sn	166	1SNA164583R1500	BJS8	68
1SNA110442R2500	D6.LL	216	1SNA115541R1100	D2.6.DA	193	1SNA164585R1700	BJS10	65
1SNA110491R1700	DR6.1	118	1SNA115542R1200	D2.6.D	194	1SNA164586R1000	BJS10	65
1SNA112086R0200	DR1.5.1	116	1SNA115547R1700	D2.6.DAL2	196	1SNA164587R1100	BJS10	65
1SNA112098R1600	DR2.5.S1	120	1SNA115591R0400	M6.DE1.D1	254	1SNA164588R2200	BJS10	65
1SNA113067R1700	FEM9	101	1SNA115626R1600	M13.FF	103	1SNA165575R2500	M16.PE.N	241
1SNA113137R0200	FEMT1	167	1SNA115627R1700	M13.FF.1	104	1SNA165680R0300	M12.PE.N	240
1SNA113542R1000	PC5-2	17	1SNA115643R2700	D2.6.DPA1	192	1SNA165683R2200	M10.PE.N	239
1SNA113544R1200	PC5-10	17	1SNA115678R0200	M8.STP.RS	67	1SNA167224R2700	BJS13-10	103
1SNA113546R1400	PC6-2	18	1SNA115685R1200	M8.RS	64	1SNA167319R0600	AL2	213
1SNA113548R2600	PC6-10	18	1SNA115831R0400	D8.ST1.RS.IP20	69	1SNA167674R0200	CB5	120
1SNA113550R2400	EIP	17	1SNA115914R0700	D8.ST.RS	68	1SNA167860R0100	FC4	19
1SNA113629R2700	FEMT2	157	1SNA115928R1500	D10.SNBTB1	163	1SNA167908R0600	PC51-10	115
1SNA113689R2400	ECP26	84	1SNA115929R1600	D10.SNBTB2	164	1SNA167927R1000	FC4-1	68
1SNA113690R2100	ECP31	85	1SNA115930R1300	M6.RS	63	1SNA168201R1200	CPP262	84
1SNA113691R1600	ECP35	86	1SNA115971R1000	M8.ST1.IP20	159	1SNA168202R1300	CPP261	84
1SNA113692R1700	ECP42	87	1SNA116536R0500	PC6-3	112	1SNA168203R1400	CPP312	85
1SNA113762R2400	PEP	84	1SNA116537R0600	PC6-4	112	1SNA168204R1500	CPP311	85
1SNA113885R0100	FEMS6	112	1SNA116538R1700	PC8-2	20	1SNA168205R1600	CPP352	86
1SNA114117R0700	SCFD	213	1SNA116539R1000	PC8-3	113	1SNA168206R1700	CPP351	86
1SNA114195R0600	FEMS8	113	1SNA116540R2500	PC8-4	113	1SNA168207R1000	CPP422	87
1SNA114205R2000	AD2.5	66	1SNA116713R1600	FEM12F	102	1SNA168208R2100	CPP421	87
1SNA114328R2200	FEMT3	165	1SNA116771R2000	FED3E	192	1SNA168273R1100	BJS10	65
1SNA114329R2300	BNT2	165	1SNA116781R1300	FEMT5	166	1SNA168401R0300	EV8S	157
1SNA114434R0500	FEMR10	65	1SNA116783R1500	CVABM1	166	1SNA168520R0500	BJM8	261
1SNA114522R0500	SCFT2	157	1SNA116795R1100	SCFCV1-2	112	1SNA168521R2200	BJM8	261
1SNA114778R0500	FEMT4	162	1SNA116951R1500	FEM8S	121	1SNA168522R2300	BJM8	261
1SNA114825R0500	SCFM6	66	1SNA116964R1200	FED6	213	1SNA168672R1100	TGA8	34
1SNA114836R0000	BFMH	84	1SNA116965R1300	FEDA6	224	1SNA168673R1200	TGA8	34
1SNA115139R1600	M26.AF	88	1SNA116977R1700	FEM13F	103	1SNA168674R1300	TGA8	34
1SNA115140R2300	M26.FF	84	1SNA116979R2100	FEMSTA	162	1SNA168675R1400	ANT	34

1SNA168956R0600	SFB2	213	1SNA179371R1600	CN5	121	1SNA199279R1700	DR8.ADO	135
1SNA168974R0000	BJM8	261	1SNA179466R0600	OUMAD	17	1SNA199283R2400	DR1.6.ADO	145
1SNA173016R1000	SCDR61	114	1SNA179623R0300	BJDP1	20	1SNA199287R2000	DR2.8.ADO	146
1SNA173058R0200	DCV	226	1SNA179625R0500	BJDP3	20	1SNA199321R2100	COCE	183
1SNA173059R0300	DCJ	112	1SNA179635R0700	CDB2	50	1SNA199336R2000	FEDAD1	17
1SNA173060R0000	DCO	113	1SNA179668R2000	BJMI6D-2	253	1SNA199341R0500	FEMAD3	41
1SNA173181R1300	PSC	165	1SNA179669R2100	BJMI6D-3	253	1SNA199352R0000	FEDAD4	29
1SNA173217R2600	BJM62	117	1SNA179670R2600	BJMI6D-4	253	1SNA199354R0200	FEDAD5	50
1SNA173218R0700	BJM62	117	1SNA179671R1300	BJMI6D-5	253	1SNA199382R2700	FEDAD7	53
1SNA173219R0000	BJM62	117	1SNA179672R1400	BJMI6D-10	253	1SNA199417R1200	FED2AD1	27
1SNA173221R2200	BJM62	213	1SNA179694R0300	ITVE	49	1SNA199420R2100	BADRL	114
1SNA173226R2700	BJM62	117	1SNA179726R0200	AJS9	68	1SNA199421R1600	FEAD1	129
1SNA173523R1100	PC81-10	33	1SNA179825R2600	ITVE2	245	1SNA199423R1000	FEAD2	141
1SNA173627R2100	EL6	20	1SNA183436R0500	CVABM	165	1SNA199433R1200	FEAD5	129
1SNA173660R1600	COCF 32	176	1SNA190001R2000	D27_FF	74	1SNA199435R1400	FEAD6	141
1SNA173815R1600	BJS9.5-2	101	1SNA190002R2100	D32_FF	75	1SNA199437R1600	FEAD3	137
1SNA173816R1700	BJS9.5-3	101	1SNA190003R2200	D42_FF	76	1SNA199439R2000	FEAD4	148
1SNA173817R1000	BJS9.5-4	101	1SNA190004R2300	D55_FF	77	1SNA199444R2500	M6.D2.2S2	245
1SNA173819R2200	BJS9.5-10	101	1SNA190005R2400	D55_FF	78	1SNA199448R0100	M6.D2.2S2.T	246
1SNA173888R2000	BP8.A4	64	1SNA190006R2500	D27_AF	79	1SNA199452R2500	M6.D2.S1R	247
1SNA173906R2200	BRC-1	165	1SNA190007R2600	D32_AF	80	1SNA199456R2100	M6.D2.S1R.T	248
1SNA173907R2300	BRC-1.5	165	1SNA190008R0700	D42_AF	81	1SNA199476R2500	FED2AD2	49
1SNA173908R0400	BRC-2.5	165	1SNA190009R0000	D55_AF	82	1SNA199480R2600	D1.6.D2.ADO	49
1SNA174393R2000	BJS12.5-2	102	1SNA190016R1600	CPUF35	74	1SNA199527R1000	DS8.P.ADO	131
1SNA174394R2100	BJS12.5-3	102	1SNA190017R1700	CPUF70	75	1SNA199528R2100	DS2.8.P.ADO	142
1SNA174395R2200	BJS12.5-5	102	1SNA190018R2000	CPUF120	76	1SNA199551R2000	SCAD5	17
1SNA174396R2300	BJS12.5-10	102	1SNA190019R2100	CPUF185	77	1SNA199554R2300	D2.5.ADO	17
1SNA174558R0500	BRC-0.5	165	1SNA196789R2400	BNSTP2	67	1SNA199555R2400	D2.5.ADO	17
1SNA174601R0100	BRC-4	165	1SNA196792R1700	BNSTP1	67	1SNA199556R2500	D2.5.N.ADO	17
1SNA174781R2500	BJDP4	63	1SNA196896R0000	SCAD	18	1SNA199563R2400	D5.ADO	41
1SNA174789R0500	BJS8-20	68	1SNA199034R1500	D6.ADO	18	1SNA199564R2500	D5.ADO	41
1SNA175263T0600	ECR-3	102	1SNA199035R1600	D6.ADO	18	1SNA199565R2600	D5.N.ADO	41
1SNA176278R1600	BJMI5-2	17	1SNA199036R1700	D6.N.ADO	18	1SNA205735R0600	BJM4	114
1SNA176279R1700	BJMI5-3	17	1SNA199042R2500	D8.ADO	20	1SNA205736R0700	BJM4	114
1SNA176280R0500	BJMI5-4	17	1SNA199043R2600	D8.ADO	20	1SNA205737R0000	BJM4	114
1SNA176281R2200	BJMI5-5	17	1SNA199044R2700	D8.N.ADO	20	1SNA205738R1100	BJM4	114
1SNA176282R2300	BJMI5-10	17	1SNA199048R0300	D6.ADO.4	19	1SNA205767R1600	DRF6	74
1SNA176663R0000	BJMI6-2	18	1SNA199050R0100	D6.P.ADO	18	1SNA205768R2700	DRF8	75
1SNA176664R0100	BJMI6-3	18	1SNA199051R2600	D1.6.ADO	42	1SNA205769R2000	DRF10	76
1SNA176665R0200	BJMI6-4	18	1SNA199052R2700	D1.6.ADO	42	1SNA205770R2500	DRF12	77
1SNA176666R0300	BJMI6-5	18	1SNA199053R2000	D1.6.N.ADO	42	1SNA205771R1200	DRF16	78
1SNA176667R0400	BJMI6-10	18	1SNA199059R0600	D2.8.ADO	43	1SNA205772R1300	BJS27-2	74
1SNA176669R1600	BJMI8-2	20	1SNA199060R0300	D2.8.ADO	43	1SNA205773R1400	BJS27-3	74
1SNA176670R1300	BJMI8-3	20	1SNA199061R2000	D2.8.N.ADO	43	1SNA205774R1500	BJS32-2	75
1SNA176671R0000	BJMI8-4	20	1SNA199064R2300	D6.ADO.2	19	1SNA205775R1600	BJS32-3	75
1SNA176672R0100	BJMI8-5	20	1SNA199091R1700	D2.8.P.ADO	43	1SNA205776R1700	BJS42-2	76
1SNA176673R0200	BJMI8-10	20	1SNA199098R2600	D1.6.P.ADO	42	1SNA205777R1000	BJS42-3	76
1SNA176675R0400	BJMI10-2	166	1SNA199107R2400	D6.SN.ADO	31	1SNA205778R2100	BJS551-2	77
1SNA176676R0500	BJMI10-3	166	1SNA199108R0500	D6.SN.ADO	31	1SNA205779R2200	BJS551-3	77
1SNA176677R0600	BJMI10-4	166	1SNA199118R2600	D8.P.ADO	20	1SNA205955R0300	BJADO5-2	29
1SNA176678R1700	BJMI10-5	166	1SNA199135R1700	BNT1	165	1SNA205956R0400	BJADO5-3	29
1SNA176679R1000	BJMI10-10	166	1SNA199136R1000	BNT3	165	1SNA205958R1600	BJADO5-5	29
1SNA176704R0200	BJMI5DR	115	1SNA199137R1100	D8.SN.ADO	33	1SNA205963R0300	BJADO5-10	29
1SNA176705R0300	BJMI5DR	115	1SNA199144R2000	D1.6.SNT2.ADO	51	1SNA205974R0600	BJADO6-2	31
1SNA176706R0400	BJMI5DR	115	1SNA199155R2300	D8.ADO.2	21	1SNA205975R0700	BJADO6-3	31
1SNA176708R1600	BJMI5DR	115	1SNA199157R2500	D8.ADO.4	21	1SNA205982R2700	BJADO6-10	31
1SNA176816R1200	CPV1-2	112	1SNA199184R1100	D2.8.SFT.ADO2	55	1SNA206394R0200	EV6I	68
1SNA177652R0600	BJS5-20	116	1SNA199186R1300	D2.8.SNNT.ADO2	55	1SNA206680R1500	AJS9-1	68
1SNA177654R0000	BJS10-20	65	1SNA199187R1400	D2.8.SFLT.ADO2	56	1SNA206681R0200	AJS9-2	68
1SNA177812R1700	EL61	192	1SNA199188R2500	D2.8.SFDT.ADO2	56	1SNA206682R0300	AJS9-3	68
1SNA178024R2500	BJD6	192	1SNA199208R1100	D1.8.SFT.ADO	53	1SNA206683R0400	AJS9-4	68
1SNA178025R2600	BJD6	192	1SNA199211R2300	D1.8.SFLT.ADO	54	1SNA206720R1400	AJS9-5	68
1SNA178026R2700	BJD6	192	1SNA199212R2400	D1.8.SFDT.ADO	54	1SNA206721R0100	AL4-M3	68
1SNA178027R2000	BJD6	192	1SNA199231R2700	D2.8.SNT2.ADO	52	1SNA206722R0200	AL4-M3-R1	64
1SNA178032R2500	BJD6	192	1SNA199235R2300	D6.SNT2.ADO	32	1SNA206723R0300	AL4-M4	65
1SNA178033R2600	BJD6	192	1SNA199242R0200	D6.D2.ADO	27	1SNA215266R0100	FEM8T6	68
1SNA178408R1400	CBD2S	27	1SNA199244R0400	D6.D2.N.ADO	27	1SNA215580R2100	FED2-4	114
1SNA178745R1400	CBM5	17	1SNA199248R1000	D1.6.ADO.D1	263	1SNA215999R2100	FED10S1	163
1SNA178944R0400	OUPAD	17	1SNA199275R0300	DR6.ADO	134	1SNA216110R2200	16SLTMM5TM5	105

Index

Part number classification

Order code	Type	Page	Order code	Type	Page	Order code	Type	Page
1SNA216112R1000	165ETTM5TM5	106	1SNA299497R2700	DS1.6.ADO	141	1SNA400712R0700	PC8-R2	157
1SNA216114R1200	FEET80	105	1SNA299501R0300	DS2.8.ADO	142	1SNA400713R0000	PC8-R3	157
1SNA229000R1500	RC410	114	1SNA299505R0700	DB6.ADO	138	1SNA400724R0300	PC8-R4	157
1SNA230000R1200	RC55	115	1SNA299509R1300	DB8.ADO	139	1SNA400753R1000	M12.FF	102
1SNA231000R0700	RC510	17	1SNA299513R2600	DB1.6.ADO	148	1SNA400813R0000	MA2.5.D2-2CPE	180
1SNA232000R0000	RC65	117	1SNA299517R2200	DB2.8.ADO	149	1SNA400814R0000	MA2.5-CPE	176
1SNA233000R0100	RC610	18	1SNA299521R2600	DH6.ADO	140	1SNA400815R0000	MA2.5-SNB-CPE	182
1SNA234000R0200	RC810	20	1SNA299529R0600	DH1.6.ADO	150	1SNA400817R0000	MA2.5-2CPE	178
1SNA235463R2300	RPA	96	1SNA299552R0500	DRE6.ADO	134	1SNA400818R0000	ENS.FEDBCP	180
1SNA236500R0600	RCT810	101	1SNA299554R0700	DRE1.6.ADO	145	1SNA400819R0000	ENS.FE-BCP	176
1SNA237000R0500	RCAL85	131	1SNA299555R0000	DRE2.8.ADO	146	1SNA400821R0000	MA2.5-2CPE1-Pb	179
1SNA238000R1600	RC1010	65	1SNA299556R0100	DSE6.ADO	130	1SNA400822R0000	MA2.5-CPE.1	177
1SNA280092R2500	CPE43	103	1SNA299557R0200	DSE8.ADO	131	1SNA400823R0000	MA2.5.D-2CPE	181
1SNA280093R2600	CPE80	105	1SNA299558R1300	DSE1.6.ADO	141	1SNA400824R0000	FEM6	176
1SNA290201R1100	DR2.5.2L	124	1SNA299559R1400	DSE2.8.ADO	142	1SNA400825R0000	FEDCP	180
1SNA290203R1300	DR2.5.N.2L	124	1SNA299632R0500	DR8.P.ADO	135	1SNA400826R0000	FE2CPE	178
1SNA290211R0200	DR2.10.4L	125	1SNA299633R0600	DR2.8.P.ADO	146	1SNA400827R0000	MA2.5-CPE	176
1SNA290213R0400	DR2.10.N.4L	125	1SNA299777R1600	COC 1	176	1SNK900001R0000	BAM4	17
1SNA290219R1200	DR2.10.P.4L	124	1SNA399030R0500	D2.5.P.ADO	17	1SNK900002R0000	BAZ1	17
1SNA290221R0400	DS2.5.2L	122	1SNA399031R2200	D5.P.ADO	41	1SNK900102R0000	BAZH1	27
1SNA290223R0600	DS2.5.N.2L	122	1SNA399226R0200	D2.5.SN.ADO	29	1SNK900652R0000	SC-JB8-2	68
1SNA290231R0600	DS2.10.4L	123	1SNA399228R1400	D2.5.SNT2.ADO	30	1SNK900653R0000	SC-JB8-3	68
1SNA290233R0000	DS2.10.N.4L	123	1SNA399231R0700	D5.SNT2.ADO	50	1SNK900654R0000	SC-JB8-4	68
1SNA290241R1000	DB2.5.2L	127	1SNA399244R1400	D8.ADO	44			
1SNA290243R1200	DB2.5.N.2L	127	1SNA399245R1500	D8.ADO3	22			
1SNA290261R1400	DH2.5.2L	128	1SNA399250R2600	D8.P.ADO	44			
1SNA290281R0100	FEDB.L	127	1SNA399251R1300	D8.P.ADO3	22			
1SNA290322R0100	D2.5.NTLPL	232	1SNA399318R1600	D8.N.ADO	44			
1SNA290324R0300	D2.5.NLPL	233	1SNA399319R1700	D8.N.ADO3	22			
1SNA290326R0500	D2.5.LLPL	234	1SNA399491R2500	DR5.ADO	144			
1SNA290328R1700	D2.5.LL.L	232	1SNA399495R2100	DRE5.ADO	144			
1SNA290330R1500	D2.5.NL.L	234	1SNA399509R1700	DR2.5.ADO	133			
1SNA290350R2100	D2.5.C3.L	198	1SNA399513R2200	DRE2.5.ADO	133			
1SNA290352R1700	D2.5.C3.LL	199	1SNA399514R2300	DS2.5.ADO	129			
1SNA290354R1100	D2.5.C4.L	200	1SNA399518R0700	DSE2.5.ADO	129			
1SNA290356R1300	D2.5.C4.L.L	201	1SNA399519R0000	DB2.5.ADO	137			
1SNA290358R2500	FED5.C3.L	198	1SNA399600R2600	D8.D2.ADO	28			
1SNA290360R2300	FED5.C4.L	200	1SNA399678R2700	FED5.C3.ADO	202			
1SNA290365R1400	PC5.34	198	1SNA399679R2000	FED5.C4.ADO	204			
1SNA290366R1500	PC5.34	198	1SNA399683R0500	PC52.10	202			
1SNA290367R1600	PC5.34	198	1SNA399684R0600	PC52.10	202			
1SNA290451R0300	BJE762.2	183	1SNA399685R0700	PC52.10	202			
1SNA290452R0400	BJE762.5	183	1SNA399689R1300	D5.C3.ADO	202			
1SNA290453R0500	BJE762.10	183	1SNA399690R1000	D5.C3.ADO.L	203			
1SNA290454R0600	EIP	183	1SNA399692R0600	D5.C4.ADO	204			
1SNA290455R0700	RB-12W7	183	1SNA399693R0700	D5.C4.ADO.L	205			
1SNA290483R2400	D2.7.ADO-CPE	184	1SNA399707R1500	PC52.66	202			
1SNA290484R2500	D2.7.2ADO-CPE	186	1SNA399708R2600	PC52.66	202			
1SNA290486R2700	D1.7.ADO-CPE	183	1SNA399709R2700	PC52.66	202			
1SNA290487R2000	D1.7.2ADO-CPE	185	1SNA399758R2700	FEDAD10	34			
1SNA290501R0000	DS2.10.4L.YL	123	1SNA399762R1300	D8.SFT2.I.ADO2	37			
1SNA291102R2300	BJDL5-2	122	1SNA399766R1700	D8.SNNT2.I.ADO2	37			
1SNA291103R2400	BJDL5-3	122	1SNA399768R2100	D8.SFLT2.I.ADO2	38			
1SNA291104R2500	BJDL5-4	122	1SNA399770R2700	D8.SFDT2.I.ADO2	38			
1SNA291105R2600	BJDL5-5	122	1SNA399777R1200	D8.SFT2.I.ADO	35			
1SNA291110R2600	BJDL5-10	122	1SNA399779R2400	D8.SNNT2.I.ADO	34			
1SNA291301R0200	FED1.L	122	1SNA399782R0000	D8.SFDT2.I.ADO	36			
1SNA291311R2300	FED2.L	122	1SNA399785R0300	D8.SF.I.ADO	34			
1SNA291322R2600	BJDL10-2	123	1SNA399800R1700	D8.ADO3	22			
1SNA291323R2700	BJDL10-3	123	1SNA399801R0400	D8.ADO	44			
1SNA291324R2000	BJDL10-4	123	1SNA399856R0200	D8.SFLT2.I.ADO	36			
1SNA291325R2100	BJDL10-5	123	1SNA399886R2100	SPBO.NTL	232			
1SNA291559R0400	FED5.LA	232	1SNA399931R2500	D6.D1.P.ADO	27			
1SNA291560R0100	FED5.LB	233	1SNA400063R0000	VRADO.CPE7	183			
1SNA291833R1700	FECPE.2ADO	185	1SNA400270R2000	D8.D2.P.SF	261			
1SNA296114R1300	FEET80	107	1SNA400271R1500	D8.D2.P.SFL	262			
1SNA296117R1600	165ETTM5TM5-2	107	1SNA400272R1600	D8.D2.P.SFD	262			
1SNA299489R0700	DS6.ADO	130	1SNA400273R1700	FEM8D2S1	261			
1SNA299493R2300	DS8.ADO	131	1SNA400711R0600	PC8-R1	157			

Index

Type classification

Type	Order code	Page	Type	Order code	Page	Type	Order code	Page
165ETTM5TM5	1SNA216112R1000	106	BJMI5-3	1SNA176279R1700	181	COCF 32	1SNA173660R1600	182
165ETTM5TM5-2	1SNA2961117R1600	107	BJMI5-4	1SNA176280R0500	181	CPE43	1SNA280092R2500	104
165LTTM5TM5	1SNA216110R2200	106	BJMI5-5	1SNA176281R2200	178	CPE80	1SNA280093R2600	107
AD2.5	1SNA114205R2000	248	BJMI5DR	1SNA176704R0200	116	CPFT10	1SNA094310R2400	182
AJS9	1SNA179726R0200	169		1SNA176705R0300	116	CPFT2	1SNA094302R2100	182
AJS9-1	1SNA206680R1500	170		1SNA176706R0400	116	CPFT3	1SNA094303R2200	182
AJS9-2	1SNA206681R0200	170		1SNA176708R1600	116	CPFT4	1SNA094304R2300	182
AJS9-3	1SNA206682R0300	170	BJMI6-10	1SNA176667R0400	63	CPFTR-10	1SNA094360R0600	182
AJS9-4	1SNA206683R0400	170	BJMI6-2	1SNA176663R0000	63	CPFTR-2	1SNA094352R2200	182
AJS9-5	1SNA206720R1400	170	BJMI6-3	1SNA176664R0100	63	CPFTR-3	1SNA094353R2300	182
AL2	1SNA163043R2100	262	BJMI6-4	1SNA176665R0200	63	CPFTR-4	1SNA094354R2400	182
	1SNA167319R0600	225	BJMI6-5	1SNA176666R0300	63	CPP261	1SNA168202R1300	92
AL4-M3	1SNA206721R0100	262	BJMI6D-10	1SNA179672R1400	260	CPP262	1SNA168201R1200	92
AL4-M3-R1	1SNA206722R0200	106	BJMI6D-2	1SNA179668R2000	260	CPP263	1SNA163403R2000	92
AL4-M4	1SNA206723R0300	65	BJMI6D-3	1SNA179669R2100	260	CPP311	1SNA168204R1500	93
ANT	1SNA168675R1400	262	BJMI6D-4	1SNA179670R2600	260	CPP312	1SNA168203R1400	93
BADRL	1SNA199420R2100	147	BJMI6D-5	1SNA179671R1300	260	CPP313	1SNA163409R0600	93
BAM4	1SNK900001R0000	263	BJMI8-10	1SNA176673R0200	64	CPP351	1SNA168206R1700	94
BAMH	1SNA114836R0000	95	BJMI8-2	1SNA176669R1600	64	CPP352	1SNA168205R1600	94
BAZ1	1SNK900002R0000	263	BJMI8-3	1SNA176670R1300	64	CPP353	1SNA163418R2600	94
BAZH1	1SNK900102R0000	262	BJMI8-4	1SNA176671R0000	64	CPP421	1SNA168208R2100	95
BJADO5-10	1SNA205963R0300	144	BJMI8-5	1SNA176672R0100	64	CPP422	1SNA168207R1000	95
BJADO5-2	1SNA205955R0300	144	BJS10	1SNA164585R1700	65	CPP423	1SNA163424R1400	95
BJADO5-3	1SNA205956R0400	144		1SNA164586R1000	65	CPUF120	1SNA190018R2000	81
BJADO5-5	1SNA205958R1600	29		1SNA164587R1100	65	CPUF185	1SNA190019R2100	82
BJADO6-10	1SNA205982R2700	263		1SNA164588R2200	65	CPUF35	1SNA190016R1600	79
BJADO6-2	1SNA205974R0600	263		1SNA168273R1100	65	CPUF70	1SNA190017R1700	80
BJADO6-3	1SNA205975R0700	263	BJS10-20	1SNA177654R0000	65	CPV1-2	1SNA176816R1200	113
BJD6	1SNA178024R2500	196	BJS12.5-10	1SNA174396R2300	102	CVABM	1SNA183436R0500	165
	1SNA178025R2600	196	BJS12.5-2	1SNA174393R2000	102	CVABM1	1SNA116783R1500	166
	1SNA178026R2700	196	BJS12.5-3	1SNA174394R2100	102	D1.6.ADO	1SNA199051R2600	42
	1SNA178027R2000	196	BJS12.5-5	1SNA174395R2200	102		1SNA199052R2700	42
	1SNA178032R2500	196	BJS13-10	1SNA167224R2700	104	D1.6.ADO.D1	1SNA199248R1000	263
	1SNA178033R2600	196	BJS27-2	1SNA205772R1300	79	D1.6.D2.ADO	1SNA199480R2600	49
BJDL10-2	1SNA291322R2600	125	BJS27-3	1SNA205773R1400	79	D1.6.N.ADO	1SNA199053R2000	42
BJDL10-3	1SNA291323R2700	125	BJS32-2	1SNA205774R1500	80	D1.6.P.ADO	1SNA199098R2600	46
BJDL10-4	1SNA291324R2000	125	BJS32-3	1SNA205775R1600	80	D1.6.SNT2.ADO	1SNA199144R2000	51
BJDL10-5	1SNA291325R2100	125	BJS42-2	1SNA205776R1700	81	D1.7.2ADO-CPE	1SNA290487R2000	185
BJDL5-10	1SNA291110R2600	236	BJS42-3	1SNA205777R1000	81	D1.7.ADO-CPE	1SNA290486R2700	183
BJDL5-2	1SNA291102R2300	236	BJS5-20	1SNA177652R0600	116	D1.8.SFDT.ADO	1SNA199212R2400	54
BJDL5-3	1SNA291103R2400	236	BJS551-2	1SNA205778R2100	82	D1.8.SFLT.ADO	1SNA199211R2300	54
BJDL5-4	1SNA291104R2500	236	BJS551-3	1SNA205779R2200	82	D1.8.SFT.ADO	1SNA199208R1100	53
BJDL5-5	1SNA291105R2600	236	BJS8	1SNA164581R1300	169	D5.ADO	1SNA199563R2400	41
BJDP1	1SNA179623R0300	44		1SNA164582R1400	169		1SNA199564R2500	41
BJDP3	1SNA179625R0500	44		1SNA164583R1500	169	D5.C3.ADO	1SNA399689R1300	202
BJDP4	1SNA174781R2500	63	BJS8-20	1SNA174789R0500	169	D5.C3.ADO.L	1SNA399690R1000	203
BJE762.10	1SNA290453R0500	186	BJS9.5-10	1SNA173819R2200	101	D5.C4.ADO	1SNA399692R0600	204
BJE762.2	1SNA290451R0300	186	BJS9.5-2	1SNA173815R1600	101	D5.C4.ADO.L	1SNA399693R0700	205
BJE762.5	1SNA290452R0400	186	BJS9.5-3	1SNA173816R1700	101	D5.N.ADO	1SNA199565R2600	41
BJM4	1SNA205735R0600	114	BJS9.5-4	1SNA173817R1000	101	D5.P.ADO	1SNA399031R2200	45
	1SNA205736R0700	114	BNSTP1	1SNA196792R1700	168	D5.SNT2.ADO	1SNA399231R0700	50
	1SNA205737R0000	114	BNSTP2	1SNA196789R2400	168	D42.AF	1SNA190008R0700	81
	1SNA205738R1100	114	BNT1	1SNA199135R1700	166	D42.FF	1SNA190003R2200	76
BJM62	1SNA173217R2600	225	BNT2	1SNA114329R2300	166	D55.AF	1SNA190009R0000	82
	1SNA173218R0700	225	BNT3	1SNA199136R1000	166	D55.FF	1SNA190004R2300	77
	1SNA173219R0000	225	BO3	1SNA164406R2400	232	D2.5.ADO	1SNA199554R2300	17
	1SNA173221R2200	225	BP8.A4	1SNA173888R2000	168		1SNA199555R2400	17
	1SNA173226R2700	225	BRC-0.5	1SNA174558R0500	166	D2.5.C3.L	1SNA290350R2100	198
BJM8	1SNA168520R0500	262	BRC-1	1SNA173906R2200	166	D2.5.C3.LL	1SNA290352R1700	199
	1SNA168521R2200	262	BRC-1.5	1SNA173907R2300	166	D2.5.C4.L	1SNA290354R1100	200
	1SNA168522R2300	262	BRC-2.5	1SNA173908R0400	166	D2.5.C4.LL	1SNA290356R1300	201
	1SNA168974R0000	262	BRC-4	1SNA174601R0100	166	D2.5.LL.L	1SNA290328R1700	236
BJMI10-10	1SNA176679R1000	166	CBD2S	1SNA178408R1400	248	D2.5.LLPL	1SNA290326R0500	235
BJMI10-2	1SNA176675R0400	166	CBD5	1SNA167674R0200	120	D2.5.N.ADO	1SNA199556R2500	17
BJMI10-3	1SNA176676R0500	166	CBM5	1SNA178745R1400	263	D2.5.NL.L	1SNA290330R1500	235
BJMI10-4	1SNA176677R0600	166	CBD2	1SNA179635R0700	51	D2.5.NLPL	1SNA290324R0300	233
BJMI10-5	1SNA176678R1700	166	CN5	1SNA179371R1600	262	D2.5.NTLPL	1SNA290322R0100	232
BJMI5-10	1SNA176282R2300	181	COC 1	1SNA299777R1600	182	D2.5.P.ADO	1SNA399030R0500	23
BJMI5-2	1SNA176278R1600	181	COCE	1SNA199321R2100	186	D2.5.SN.ADO	1SNA399226R0200	29

Index

Type classification

Type	Order code	Page	Type	Order code	Page	Type	Order code	Page
D2.5.SNT2.ADO	1SNA399228R1400	30		1SNA399800R1700	22	DSE1.6.ADO	1SNA299558R1300	141
D2.6.D	1SNA115542R1200	194	D8.D2.ADO	1SNA399600R2600	28	DSE2.5.ADO	1SNA399518R0700	129
D2.6.DA	1SNA115541R1100	193	D8.N.ADO	1SNA199044R2700	20	DSE2.8.ADO	1SNA299559R1400	142
D2.6.DAL2	1SNA115547R1700	196	D8.N.ADO3	1SNA399319R1700	22	DSE6.ADO	1SNA299556R0100	130
D2.6.DL	1SNA115537R0500	195	D8.P.ADO	1SNA199118R2600	25	DSE8.ADO	1SNA299557R0200	131
D2.6.DPA1	1SNA115643R2700	192	D8.P.ADO3	1SNA399251R1300	26	ECP26	1SNA113689R2400	96
D2.7.2ADO-CPE	1SNA290484R2500	186	D8.ST.RS	1SNA115914R0700	169	ECP31	1SNA113690R2100	96
D2.7.ADO-CPE	1SNA290483R2400	184	D8.ST1.RS.IP20	1SNA115831R0400	170	ECP35	1SNA113691R1600	96
D2.8.ADO	1SNA199059R0600	43	D32.AF	1SNA190007R2600	80	ECP42	1SNA113692R1700	96
D2.8.ADO	1SNA199060R0300	43	D32.FF	1SNA190002R2100	75	ECR-3	1SNA175263T0600	102
D2.8.N.ADO	1SNA199061R2000	43	DB1.6.ADO	1SNA299513R2600	148	EIP	1SNA113550R2400	248
D2.8.P.ADO	1SNA199091R1700	47	DB2.5.2L	1SNA290241R1000	127		1SNA290454R0600	186
D2.8.SFDT.ADO2	1SNA199188R2500	56	DB2.5.ADO	1SNA399519R0000	137	EL6	1SNA173627R2100	262
D2.8.SFLT.ADO2	1SNA199187R1400	56	DB2.5.N.2L	1SNA290243R1200	127	EL61	1SNA177812R1700	196
D2.8.SFT.ADO2	1SNA199184R1100	57	DB2.8.ADO	1SNA299517R2200	149	ENS.FE-BCP	1SNA400819R0000	177
D2.8.SNNT.ADO2	1SNA199186R1300	57	DB6.ADO	1SNA299505R0700	138	ENS.FEDBCP	1SNA400818R0000	181
D2.8.SNT2.ADO	1SNA199231R2700	52	DB8.ADO	1SNA299509R1300	139	EV6I	1SNA206394R0200	169
D55.FF	1SNA190005R2400	78	DCB	1SNA105028R2100	182	EV8S	1SNA168401R0300	161
D27.AF	1SNA190006R2500	79	DCJ	1SNA173059R0300	112	FC2	1SNA007865R2600	248
D27.FF	1SNA190001R2000	74	DCO	1SNA173060R0000	113	FC2.MC	1SNA107239R0300	57
D6.A.LLP	1SNA110418R2500	225	DCV	1SNA173058R0200	227	FC4	1SNA167860R0100	168
D6.A.NTLP	1SNA110415R1200	224	DH1.6.ADO	1SNA299529R0600	150	FC4-1	1SNA167927R1000	170
D6.ADO	1SNA199034R1500	18	DH2.5.2L	1SNA290261R1400	128	FE2CPE	1SNA400826R0000	182
	1SNA199035R1600	18	DH6.ADO	1SNA299521R2600	140	FEAD1	1SNA199421R1600	140
D6.ADO.2	1SNA199064R2300	19	DR1.4	1SNA110106R2500	114	FEAD2	1SNA199423R1000	150
D6.ADO.4	1SNA199048R0300	19	DR1.5	1SNA115510R1600	115	FEAD3	1SNA199437R1600	139
D6.D1.P.ADO	1SNA399931R2500	27	DR1.5.1	1SNA112086R0200	116	FEAD4	1SNA199439R2000	149
D6.D2.ADO	1SNA199242R0200	27	DR1.6.ADO	1SNA199283R2400	145	FEAD5	1SNA199433R1200	140
D6.D2.N.ADO	1SNA199244R0400	27	DR5.ADO	1SNA399491R2500	144	FEAD6	1SNA199435R1400	150
D6.LL	1SNA110442R2500	216	DR2.10.4L	1SNA290211R0200	125	FECPE.2ADO	1SNA291833R1700	186
D6.LLP	1SNA110441R2400	215	DR2.10.N.4L	1SNA290213R0400	125	FED1.L	1SNA291301R0200	128
D6.LNTP1	1SNA110264R0200	217	DR2.10.P.4L	1SNA290219R1200	126	FED10S1	1SNA215999R2100	164
D6.LNTP2	1SNA110327R2100	219	DR2.5.2L	1SNA290201R1100	124	FED2.L	1SNA291311R2300	128
D6.LNTP3	1SNA110269R1700	218	DR2.5.ADO	1SNA399509R1700	133	FED2-4	1SNA215580R2100	114
D6.LNTP4	1SNA110328R0200	221	DR2.5.N.2L	1SNA290203R1300	124	FED2AD1	1SNA199417R1200	28
D6.LNTP6	1SNA110331R2500	223	DR2.5.S1	1SNA112098R1600	120	FED2AD2	1SNA199476R2500	49
D6.LNTP7	1SNA110332R2600	222	DR2.8.ADO	1SNA199287R2000	146	FED3E	1SNA116771R2000	196
D6.LNTP8	1SNA110333R2700	220	DR2.8.P.ADO	1SNA299633R0600	147	FED5.C3.ADO	1SNA399678R2700	203
D6.N.ADO	1SNA199036R1700	18	DR6	1SNA110251R0500	117	FED5.C3.L	1SNA290358R2500	199
D6.NLP	1SNA110440R0700	214	DR6.1	1SNA110491R1700	118	FED5.C4.ADO	1SNA399679R2000	205
D6.NTLP	1SNA110439R2200	213	DR6.1.N	1SNA120491R1100	118	FED5.C4.L	1SNA290360R2300	201
D6.P.ADO	1SNA199050R0100	24	DR6.ADO	1SNA199275R0300	134	FED5.L.A	1SNA291559R0400	232
D6.SN.ADO	1SNA199107R2400	31	DR6.N	1SNA120251R0700	117	FED5.L.B	1SNA291560R0100	236
	1SNA199108R0500	31	DR6.P	1SNA160496R2600	119	FED6	1SNA116964R1200	216
D6.SNT2.ADO	1SNA199235R2300	32	DR8.ADO	1SNA199279R1700	135	FEDA6	1SNA116965R1300	225
D8.ADO	1SNA399244R1400	44	DR8.P.ADO	1SNA299632R0500	136	FEDAD1	1SNA199336R2000	26
	1SNA399801R0400	44	DR8.SF	1SNA110368R1200	121	FEDAD10	1SNA399758R2700	40
D8.D2.P.SF	1SNA400270R2000	261	DRE1.6.ADO	1SNA299554R0700	145	FEDAD4	1SNA199352R0000	33
D8.D2.P.SFD	1SNA400272R1600	262	DRE5.ADO	1SNA399495R2100	144	FEDAD5	1SNA199354R0200	52
D8.D2.P.SFL	1SNA400271R1500	262	DRE2.5.ADO	1SNA399513R2200	133	FEDAD7	1SNA199382R2700	57
D8.N.ADO	1SNA399318R1600	44	DRE2.8.ADO	1SNA299555R0000	146	FEDB.L	1SNA290281R0100	127
D8.P.ADO	1SNA399250R2600	48	DRE6.ADO	1SNA299552R0500	134	FEDCP	1SNA400825R0000	181
D8.SF1.ADO	1SNA399785R0300	34	DRF10	1SNA205769R2000	81	FEDR5	1SNA117318R2300	116
D8.SFDT2.I.ADO	1SNA399782R0000	36	DRF12	1SNA205770R2500	82	FEDR51	1SNA117668R0200	120
D8.SFDT2.I.ADO2	1SNA399770R2700	38	DRF16	1SNA205771R1200	78	FEDR61	1SNA117600R0300	119
D8.SFLT.I.ADO	1SNA399856R0200	36	DRF6	1SNA205767R1600	79	FEET80	1SNA216114R1200	106
D8.SFLT2.I.ADO2	1SNA399768R2100	38	DRF8	1SNA205768R2700	80		1SNA296114R1300	107
D8.SFT2.I.ADO	1SNA399777R1200	39	DS1.6.ADO	1SNA299497R2700	141	FEM12F	1SNA116713R1600	102
D8.SFT2.I.ADO2	1SNA399762R1300	40	DS2.10.4L	1SNA290231R0600	123	FEM13F	1SNA116977R1700	104
D8.SN.ADO	1SNA199137R1100	33	DS2.10.4L.YL	1SNA290501R0000	123	FEM6	1SNA118368R1600	230
D8.SNNT2.I.ADO	1SNA399779R2400	39	DS2.10.N.4L	1SNA290233R0000	123		1SNA400824R0000	177
D8.SNNT2.I.ADO2	1SNA399766R1700	40	DS2.5.2L	1SNA290221R0400	122	FEM6D	1SNA118499R2300	260
D10.SNBTB1	1SNA115928R1500	163	DS2.5.ADO	1SNA399514R2300	129	FEM8D2S1	1SNA400273R1700	262
D10.SNBTB2	1SNA115929R1600	164	DS2.5.N.2L	1SNA290223R0600	122	FEM8S	1SNA116951R1500	121
D8.ADO	1SNA199042R2500	20	DS2.8.ADO	1SNA299501R0300	142	FEM8T6	1SNA215266R0100	170
	1SNA199043R2600	20	DS2.8.P.ADO	1SNA199528R2100	143	FEM9	1SNA113067R1700	101
D8.ADO.2	1SNA199155R2300	21	DS6.ADO	1SNA299489R0700	130	FEMAD3	1SNA199341R0500	263
D8.ADO.4	1SNA199157R2500	21	DS8.ADO	1SNA299493R2300	131	FEMR10	1SNA114434R0500	65
D8.ADO3	1SNA399245R1500	22	DS8.P.ADO	1SNA199527R1000	132	FEMR8	1SNA116987R0200	64

Index

Type classification

Type	Order code	Page	Type	Order code	Page	Type	Order code	Page
FEMR8T	1SNA116991R0600	67	M8.STP1	1SNA115529R1500	167	SCDR61	1SNA173016R1000	119
FEMS6	1SNA113885R0100	112	M8.STP3	1SNA115500R2500	168	SCF6	1SNA118707R0300	66
FEMS8	1SNA114195R0600	113	M9.EE	1SNA115201R2500	101	SCF9	1SNA103672R0100	102
FEMSTA	1SNA116979R2100	162	M31.AF	1SNA115142R1100	89	SCFCV1-2	1SNA116795R1100	113
FEMT1	1SNA113137R0200	168	M31.F	1SNA115144R1300	93	SCFD	1SNA114117R0700	225
FEMT2	1SNA113629R2700	161	M31.FF	1SNA115143R1200	85	SCFEX1	1SNA103619R0400	240
FEMT3	1SNA114328R2200	165	MA2.5.D2-2CPE	1SNA125961R1000	180	SCFEX3	1SNA103620R0100	240
FEMT4	1SNA114778R0500	162		1SNA400813R0000	180	SCFM6	1SNA114825R0500	240
FEMT5	1SNA116781R1300	166	MA2.5.D-2CPE	1SNA400823R0000	181	SCFT1	1SNA103588R2600	168
FU520	1SNA008288R1500	262	MA2.5.NT	1SNA125487R0600	226	SCFT2	1SNA114522R0500	161
	1SNA008289R1600	121	MA2.5-2CPE	1SNA125711R1500	178	SC-JB8-2	1SNK900652R0000	170
	1SNA008290R1300	262		1SNA400817R0000	178	SC-JB8-3	1SNK900653R0000	170
	1SNA008291R0000	262	MA2.5-2CPE1-Pb	1SNA400821R0000	179	SC-JB8-4	1SNK900654R0000	170
	1SNA008292R0100	121	MA2.5-CPE	1SNA400814R0000	176	SFB1	1SNA163860R0500	232
ITVE	1SNA179694R0300	49		1SNA400827R0000	176	SFB2	1SNA168956R0600	232
ITVE2	1SNA179825R2600	246	MA2.5-CPE.1	1SNA400822R0000	177	SPBO.NTL	1SNA399886R2100	236
M10.NT	1SNA125121R0600	229	MA2.5-SNB-CPE	1SNA400815R0000	182	TGA8	1SNA168672R1100	262
M10.PE.N	1SNA165683R2200	239	MS6	1SNA105265R0300	112		1SNA168673R1200	262
M10.RS	1SNA115320R2700	65		1SNA115265R2400	112		1SNA168674R1300	262
M10.ST-Sn	1SNA115539R1700	166	MS8	1SNA115278R0100	113	VRADO.CPE7	1SNA400063R0000	186
M35.AF	1SNA115145R1400	90	MTC6	1SNA115206R2200	197	VRB3	1SNA128035R1600	231
M35.F	1SNA115147R1600	94	MTC6.Ex	1SNA146227R2500	197	VRB6	1SNA128361R0100	230
M35.FF	1SNA115146R1500	86	OUMAD	1SNA179466R0600	263	VSJ11	1SNA163394R2600	65
M12.NT1	1SNA125593R0000	230	OUPAD	1SNA178944R0400	263			
M12.PE.N	1SNA165680R0300	240	PC10-10	1SNA163315R2600	166			
M42.AF	1SNA115148R2700	91	PC5.34	1SNA290365R1400	201			
M42.F	1SNA115150R2500	95		1SNA290366R1500	201			
M42.FF	1SNA115149R2000	87		1SNA290367R1600	201			
M16.NT	1SNA125358R0300	231	PC5-10	1SNA113544R1200	182			
M16.PE.N	1SNA165575R2500	241	PC51-10	1SNA167908R0600	116			
M26.AF	1SNA115139R1600	88	PC5-2	1SNA113542R1000	182			
M26.F	1SNA115141R1000	92	PC52.10	1SNA399683R0500	205			
M26.FF	1SNA115140R2300	84		1SNA399684R0600	205			
M6.D2.2S2	1SNA199444R2500	245		1SNA399685R0700	205			
M6.D2.2S2.T	1SNA199448R0100	246	PC52.66	1SNA399707R1500	205			
M6.D2.S1R	1SNA199452R2500	247		1SNA399708R2600	205			
M6.D2.S1R.T	1SNA199456R2100	248		1SNA399709R2700	205			
M6.DD	1SNA115168R2300	256	PC6-10	1SNA113548R2600	248			
M6.DD1	1SNA115184R0400	257	PC61-10	1SNA163311R2200	260			
M6.DE	1SNA115185R0500	258	PC6-2	1SNA113546R1400	248			
M6.DE1	1SNA115177R1400	259	PC6-3	1SNA116536R0500	248			
M6.DE1.D	1SNA115371R2600	253	PC6-4	1SNA116537R0600	248			
M6.DE1.D1	1SNA115591R0400	254	PC8-10	1SNA163313R2400	168			
M6.DE2	1SNA115326R1100	260	PC81-10	1SNA173523R1100	262			
M6.DE2.D	1SNA115327R1200	255	PC8-2	1SNA116538R1700	168			
M6.N.RS	1SNA125930R1500	63	PC8-3	1SNA116539R1000	168			
M6.NT	1SNA125117R0200	227	PC8-4	1SNA116540R2500	168			
M6.RS	1SNA115930R1300	63	PC8-R1	1SNA400711R0600	161			
M6.SNTS	1SNA115229R2000	66	PC8-R2	1SNA400712R0700	161			
M6.ST.Au	1SNA115314R1500	165	PC8-R3	1SNA400713R0000	161			
M6.ST.Sn	1SNA115313R1400	165	PC8-R4	1SNA400724R0300	161			
M12.FF	1SNA115262R2100	102	PEP	1SNA113762R2400	96			
	1SNA115263R2200	102	PSC	1SNA173181R1300	166			
	1SNA115511R0300	102	PT101	1SNA163181R1100	65			
	1SNA400753R1000	102	RB-12W7	1SNA290455R0700	186			
M13.FF	1SNA115626R1600	103	RC1010	1SNA238000R1600	231			
M13.FF.1	1SNA115627R1700	104	RC410	1SNA229000R1500	114			
M8.NT	1SNA125119R1400	228	RC510	1SNA231000R0700	226			
M8.RS	1SNA115685R1200	64	RC55	1SNA230000R1200	236			
M8.ST	1SNA115236R1700	157	RC610	1SNA233000R0100	263			
M8.ST1	1SNA115237R1000	158	RC65	1SNA232000R0000	225			
M8.ST1.IP20	1SNA115971R1000	159	RC810	1SNA234000R0200	262			
M8.ST3	1SNA115239R2200	160	RCAL85	1SNA237000R0500	149			
M8.ST7	1SNA115243R2600	161	RCT810	1SNA236500R0600	102			
M8.STA	1SNA115359R0200	162	REH3	1SNA163155R2600	107			
M8.STP	1SNA105141R2700	168	RPA	1SNA235463R2300	96			
	1SNA105142R2000	168	SCAD	1SNA196896R0000	49			
	1SNA115277R2000	168	SCAD5	1SNA199551R2000	41			
M8.STP.RS	1SNA115678R0200	67	SCD	1SNA103189R2600	225			





RGW RING LUG TERMINAL BLOCKS

Stud technology

ENTRELEC Terminal Blocks

RGW Ring lug terminal blocks

Stud technology

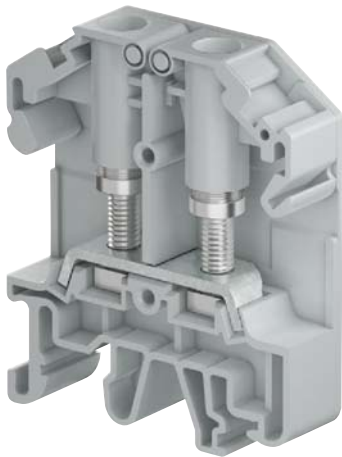

Fast and secured wiring for ring lugs

The RGW terminal blocks offer a combination of fast and secured wiring. Thanks to its exceptional design, the nuts are captive in a pivoting wing and provide a convenient wiring of ring lugs.

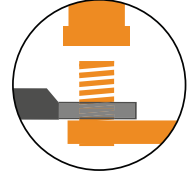

Speed up your processes

Fast ring lug connection

- 45% faster than open style terminal blocks thanks to captive and ready to tighten nuts
- No need to remove the nuts for the first use
- Easy 3 steps wiring.

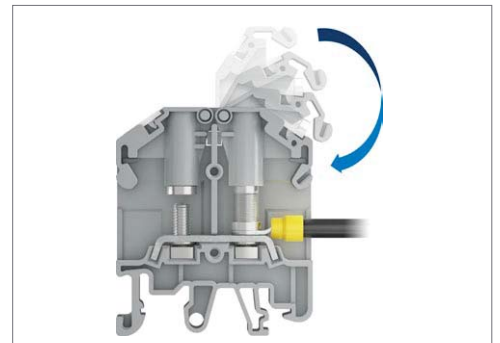

Security and protection

Secured wiring

- 100% captive wire connection: optimal combination of stud, safety wings, captive nut and ring lug
- Self-locking wings to prevent sudden opening
- Touch proof design.



Improve installation efficiency

Convenient installation

- 15% more compact: save space on the DIN Rail versus open style terminal blocks
- Universal foot for mounting on symmetrical and asymmetrical DIN Rails.

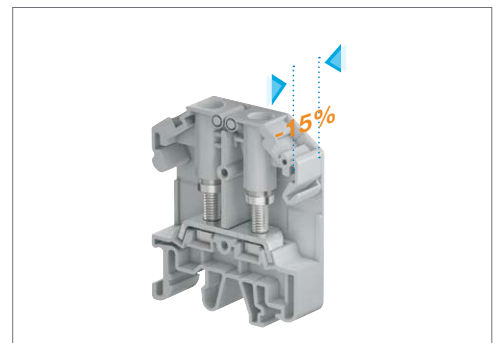

1SNC166020S0201

Features

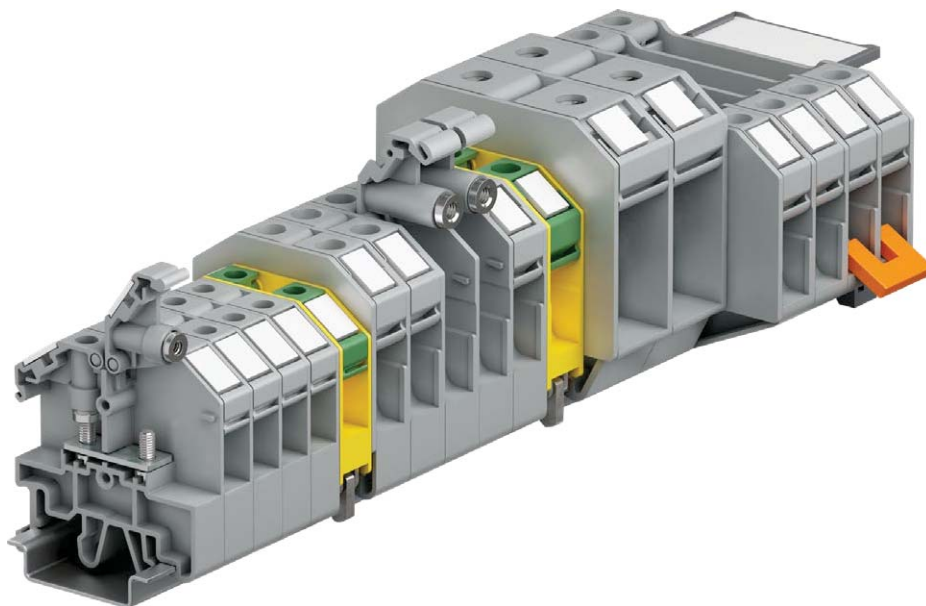
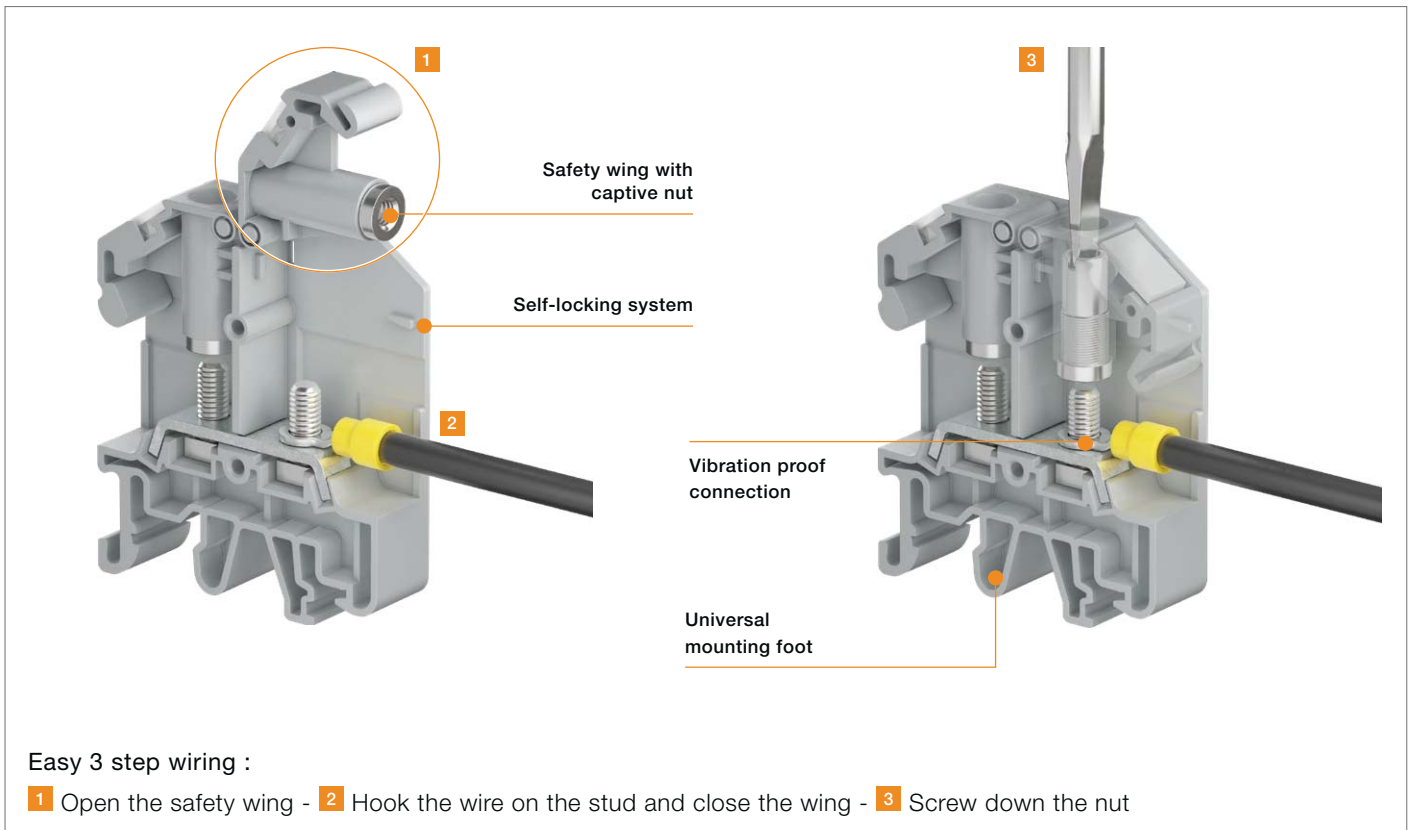

RGW Ring lug terminal blocks

Stud technology - Range overview from 2.5 to 25 mm² - 14 to 4 AWG

2.5 mm² 14 AWG

Feed-through
Feed-through
with test sockets
Ground

6 mm² 10 AWG

Feed-through
Feed-through
with test sockets
Ground

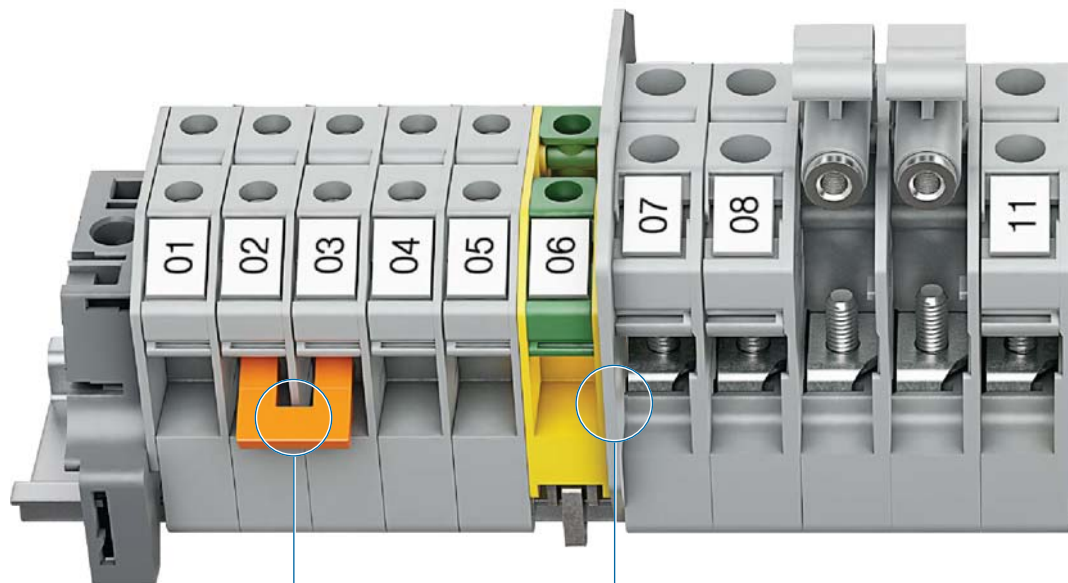

Jumper bars
from 2 to 10 poles

Convenient circuit separator
circuit & voltage separation

ISNCT16802280201

25 mm² 4 AWG

Feed-through

6 mm² 10 AWG

Feed-through with test sockets

Disconnect with sliding link

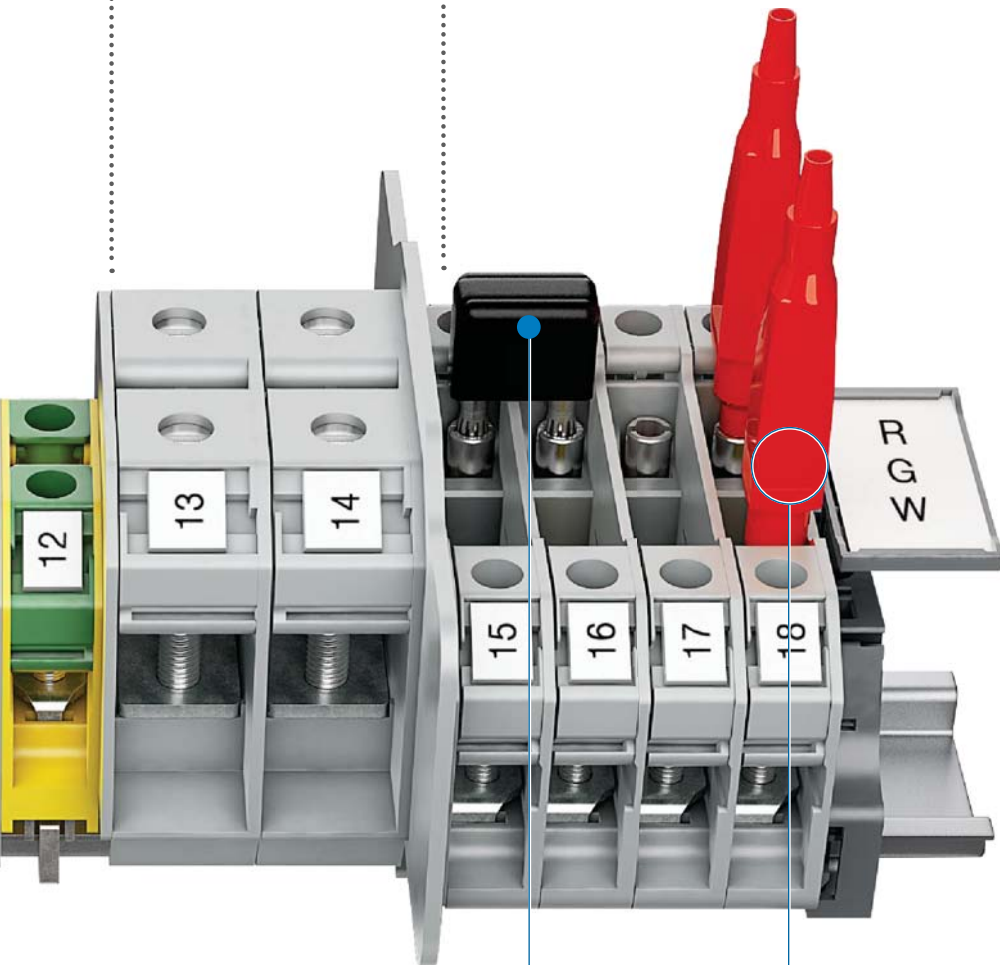

Easy CT short circuiting
with short-circuit plug

Convenient testing
test sockets compatible with
DIA 4 mm test plugs

RGW Ring lug terminal blocks

Applications & certifications

Qualified for worldwide markets, applications and for severe environments: vibration, shock...

Industry



Ring lug technology is a long time approved technology in the industry (i.e semi conductor production line) for it's proven reliability. The 100% captive connection secures the wiring.

Utility



Thanks to a 100% captive connection our RGW terminal blocks are well adapted to the power, medium and low voltage switchgear panels where a full secured connection is required.

HVAC



RGW terminal blocks are well adapted to HVAC application requesting ring lug terminals providing at the same time a vibration proof connection and increased productivity.



RoHS



Railway



Rail vehicles are subjected to extreme environmental conditions. RGW terminal blocks are part of the ENTRELEC railway terminal blocks offering, the largest of the market. RGW terminal blocks are tested in accordance with the latest and most demanding standards applying to rolling stock applications.

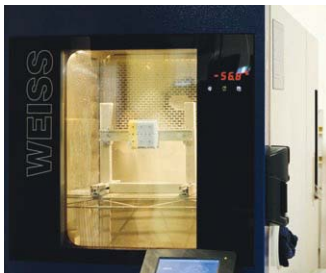

IEC 61373 Railway applications – Rolling stock equipment – Shock and vibration tests
RGW terminal blocks are complying with **category 1 (body mounted) class B**.

EN 45545-2 Railway applications. Fire protection on railway vehicles. Requirements for fire behavior of materials and components

RGW terminal blocks plastic materials are rated **HL3 R22 (the highest Hazard level)**. They can be used on vehicles for subway, tube, sleeping and couchette.

NF F 16-101 Directive relative to selecting materials in relation to their fire resistance in terms of its behavior in a fire, the opacity of smoke and the toxicity of the gas released.

NF F 16-102 Complement to NF F 16-101. The purpose of this standard is to specify the application of NF F 16-101 to electrical equipment and especially to individual apparatus.

RGW terminal blocks plastic materials are rated **I2F2. Level 3**. This level concern products mounted inside a room for passengers or running crew.

IEC 60068-2.1/IEC 60068-2.2/IEC 60068-2.78/IEC 60068-2.30 : Environmental test

RGW terminal blocks have successfully passed the damp heat, dry heat, cold climatic test.

UL94 (North America) Standard for Safety of Flammability of Plastic Materials for Parts in Devices and Appliances testing

RGW terminal blocks plastic materials are rated **UL94 V0**.



RGW2.5 Ring lug terminal blocks

Feed-through - 9 mm 0.354 in spacing

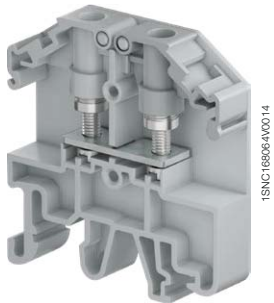
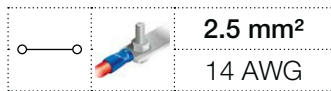

RGW2.5

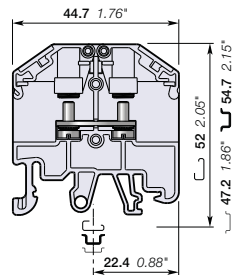

9 mm 0.354 in spacing

Description

- Stud terminal block for ring lug connection,
- Integrated captive nuts in protective wings provide easy and secured connection,
- Universal mounting on symmetrical and asymmetrical rails.

Ordering details

Description	Color	Type	Part Numbers	Pkg qty	Weight (1 pce) g
Feed-through With 2 studs M3 and captive nuts in wings	Grey <input type="checkbox"/>	RGW2.5-V0	1SNA510003R0000	45	11.78

Main technical data

Lugs	Rigid: Solid/Stranded Flexible with insulated ferrule Gauge	IEC	UL	CSA
		0.1 ... 2.5 mm ²	26 ... 14 AWG	26 ... 14 AWG
Rated current		24 A	15 A	20 A
Maximum current			20 A	
Rated cross section		2.5 mm ²	14 AWG	14 AWG
Rated short-time withstand current (1s)		300 A		
Rated voltage		800 V	600 V	600 V
Impulse withstand voltage		8000 V		
Protection		IP10	NEMA 1	

Mounting instructions

Rail		G32, TH 35-7.5, TH 35-15
Nuts		Flat screwdriver Ø 4 mm
Tool		Ø 0.157 in
Torque		0.6 ... 0.8 N.m 5.3 ... 7.1 lb.in
Max width of lug		7 mm 0.28 in

The connecting capacity data for one Rigid: Solid/Stranded, or one Flexible conductor (when applicable) is a mandatory information required by IEC, UL and CSA standards (Copper conductors). All other data are provided as supplementary information only. For more details, please consult our CB, UL or CSA certificates and technical datasheet available on <http://www.TE.com>

CE	RoHS	UL USR CNR	CSA

Accessories

Description	Color	Type	Part Numbers	Pkg qty	Weight (1 pce) g	
1 End stops 10 mm 0.394 in	Dark grey <input checked="" type="checkbox"/>	BAM4	1SNK900001R0000	50	14.00	
2 End sections 1.2 mm 0.047 in	Grey <input type="checkbox"/>	E-RGW2.5	1SNA519003R0000	25	1.89	
3 Lateral jumper bars	Orange <input checked="" type="checkbox"/>	2 poles 24 A (IEC)	PC-RG2.5-2	1SNA519103R0200	25	3.02
		3 poles 24 A (IEC)	PC-RG2.5-3	1SNA519103R0300	20	4.69
		4 poles 24 A (IEC)	PC-RG2.5-4	1SNA519103R0400	15	6.36
		10 poles 24 A (IEC)	PC-RG2.5-10	1SNA519103R1000	5	16.39
4 Circuit separators 1.5 mm 0.059 in	Grey <input type="checkbox"/>	CS-RGW-S	1SNA519200R0000	25	4.59	
5 Terminal block markers	White <input type="checkbox"/>	M-W610PC	1SNA235511R0600	360	8.03	
		MG-CPM-01 41090	1SNB041090R0510	1960	0.351	

Complete list of accessories is indicated in the terminal block datasheet including end stops.

Some accessories such as jumper bars may modify the terminal block's ratings: Complete information available in the accessories section of the catalog.

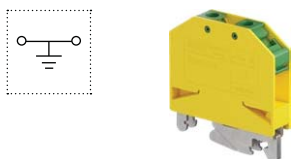

Ground Ring lug terminal blocks

Description	Color	Type	Part Numbers	Pkg qty	Weight (1 pce) g
Ground With 2 studs M3 and captive nuts in wings	Green-yellow <input checked="" type="checkbox"/>	RGW2.5-PE-V0	1SNA511003R0500	45	28.56

Technical data valid for copper conductors only.

RGW2.5-T Ring lug terminal blocks

Feed-through with test sockets - 9 mm 0.354 in spacing

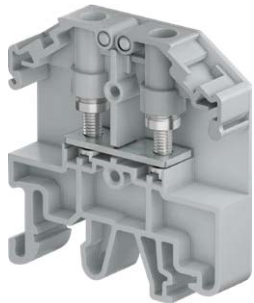
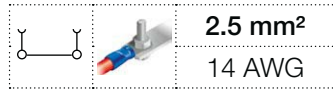

RGW2.5-T

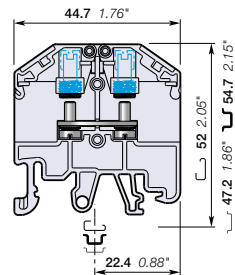

9 mm 0.354 in spacing

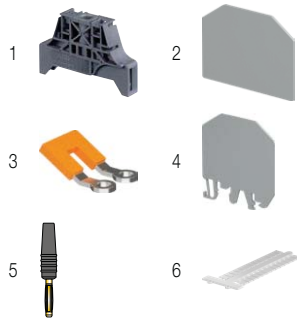

Description

- Stud terminal block for ring lug connection,
- Integrated captive nuts in protective wings provide easy and secured connection,
- Ease your test operations with the 2 built-in nuts with test sockets compatible with DIA 2 mm 0.079 in,
- Universal mounting on symmetrical and asymmetrical rails.

Ordering details

Description	Color	Type	Part Number	Pkg qty	Weight (1 pce) g
Feed-through With 2 studs M3 and captive nuts in wings	Grey <input type="checkbox"/>	RGW2.5-T-V0	1SNA510103R0000	45	11.58

Main technical data

	IEC	UL	CSA
Lugs	Rigid: Solid/Stranded Flexible with insulated ferrule Gauge	0.1 ... 2.5 mm ² 0.1 ... 2.5 mm ²	26 ... 14 AWG 26 ... 14 AWG
Rated current	24 A	15 A	20 A
Maximum current		20 A	
Rated cross section	2.5 mm ²	14 AWG	14 AWG
Rated short-time withstand current (1s)	300 A		
Rated voltage	800 V	600 V	600 V
Impulse withstand voltage	8000 V		
Protection	IP10	NEMA 1	

Mounting instructions

Rail		G32, TH 35-7.5, TH 35-15
Nuts		Flat screwdriver Ø 4 mm Ø 0.157 in
Tool		
Torque		0.6 ... 0.8 N.m 5.3 ... 7.1 lb.in
Max width of lug		7 mm 0.28 in

The connecting capacity data for one Rigid: Solid/Stranded, or one Flexible conductor (when applicable) is a mandatory information required by IEC, UL and CSA standards (Copper conductors). All other data are provided as supplementary information only. For more details, please consult our CB, UL or CSA certificates and technical datasheet available on <http://www.TE.com>

CE	RoHS	UL US	CSA
CE	RoHS	UL US	CSA

Accessories

Description	Color	Type	Part Number	Pkg qty	Weight (1 pce) g
1 End stops	Dark grey <input type="checkbox"/>	BAM4	1SNK900001R0000	50	14.00
2 End sections	Grey <input type="checkbox"/>	E-RGW2.5	1SNA519003R0000	25	1.89
3 Lateral jumper bars	Orange <input type="checkbox"/>	PC-RG2.5-2	1SNA519103R0200	25	3.02
		PC-RG2.5-3	1SNA519103R0300	20	4.69
		PC-RG2.5-4	1SNA519103R0400	15	6.36
		PC-RG2.5-10	1SNA519103R1000	5	16.39
4 Circuit separators	Grey <input type="checkbox"/>	CS-RGW-S	1SNA519200R0000	25	4.59
5 Test plugs	Black <input type="checkbox"/>	FC2.MC	1SNA107239R0300	20	1.00
6 Terminal block markers	White <input type="checkbox"/>	M-W610PC	1SNA235511R0600	360	8.03
		MG-CPM-01 41090	1SNB041090R0510	1960	0.351

Complete list of accessories is indicated in the terminal block datasheet including end stops.

Some accessories such as jumper bars may modify the terminal block's ratings: Complete information available in the accessories section of the catalog.

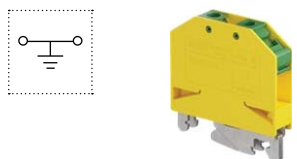

Ground Ring lug terminal blocks

Description	Color	Type	Part Number	Pkg qty	Weight (1 pce) g
Ground With 2 studs M3 and captive nuts in wings	Green-yellow <input type="checkbox"/>	RGW2.5-PE-V0	1SNA511003R0500	45	28.56

Technical data valid for copper conductors only.

RGW6 Ring lug terminal blocks

Feed-through - 11 mm 0.433 in spacing

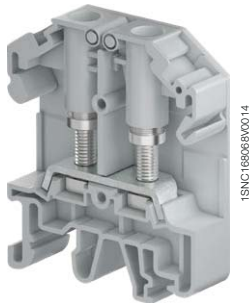
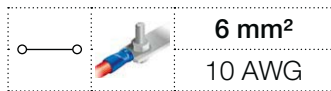

RGW6

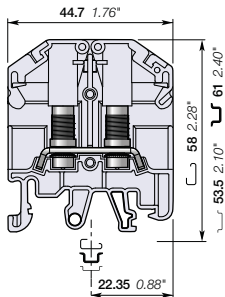

11 mm 0.433 in spacing

Description

- Stud terminal block for ring lug connection,
- Integrated captive nuts in protective wings provide easy and secured connection,
- Universal mounting on symmetrical and asymmetrical rails.

Ordering details

Description	Color	Type	Part Numbers	Pkg qty	Weight (1 pce) g
Feed-through With 2 studs M4 and captive nuts in wings	Grey <input type="checkbox"/>	RGW6-V0	1SNA510024R0000	40	19.76

Main technical data

Lugs	Rigid: Solid/Stranded Flexible with insulated ferrule Gauge	IEC	UL	CSA
		0.1 ... 6 mm²	22 ... 10 AWG	22 ... 10 AWG
Rated current		41 A	30 A	30 A
Maximum current			30 A	
Rated cross section	6 mm²		10 AWG	10 AWG
Rated short-time withstand current (1s)	720 A			
Rated voltage	800 V	600 V	600 V	
Impulse withstand voltage	8000 V			
Protection	IP10	NEMA 1		

Mounting instructions

Rail		G32, TH 35-7.5, TH 35-15
Nuts		Flat screwdriver Ø 5.5 mm Ø 0.217 in
Tool		
Torque		0.8 ... 1.2 N.m 7.1 ... 10.6 lb.in
Max width of lug		9.4 mm 0.37 in

The connecting capacity data for one Rigid: Solid/Stranded, or one Flexible conductor (when applicable) is a mandatory information required by IEC, UL and CSA standards (Copper conductors). All other data are provided as supplementary information only. For more details, please consult our CB, UL or CSA certificates and technical datasheet available on <http://www.TE.com>

CE	RoHS	UL	CSA

Accessories

Description	Color	Type	Part Numbers	Pkg qty	Weight (1 pce) g	
1 End stops 10 mm 0.394 in	Dark grey <input type="checkbox"/>	BAM4	1SNK900001R0000	50	14.00	
2 End sections 1.4 mm 0.055 in	Grey <input type="checkbox"/>	E-RGW6	1SNA519004R0000	50	2.65	
3 Lateral jumper bars	Orange <input type="checkbox"/>	2 poles 41 A (IEC)	PC-RG6-2	1SNA519104R0200	25	3.44
		3 poles 41 A (IEC)	PC-RG6-3	1SNA519104R0300	20	5.40
		4 poles 41 A (IEC)	PC-RG6-4	1SNA519104R0400	15	7.33
		7 poles 41 A (IEC)	PC-RG6-7	1SNA519104R0700	5	13.24
		10 poles 41 A (IEC)	PC-RG6-10	1SNA519104R1000	5	19.05
4 Circuit separators 1.5 mm 0.059 in	Grey <input type="checkbox"/>	CS-RGW-S	1SNA519200R0000	25	4.59	
5 Terminal block markers	White <input type="checkbox"/>	M-W810PC	1SNA235510R0800	260	0.27	
		MG-CPM-01 41096	1SNB041096R0810	1120	0.400	

Complete list of accessories is indicated in the terminal block datasheet including end stops.

Some accessories such as jumper bars may modify the terminal block's ratings: Complete information available in the accessories section of the catalog.



Ground Ring lug terminal blocks

Description	Color	Type	Part Numbers	Pkg qty	Weight (1 pce) g
Ground With 2 studs M4 and captive nuts in wings	Green-yellow <input type="checkbox"/>	RGW6-PE-V0	1SNA511024R0500	40	31.76

Technical data valid for copper conductors only.

RGW6-T Ring lug terminal blocks

Feed-through with test sockets - 11 mm 0.433 in spacing

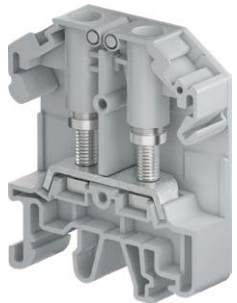
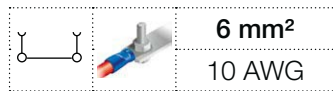

RGW6-T

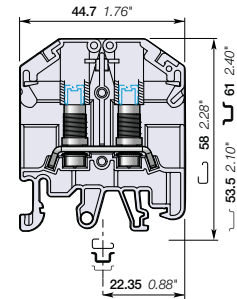

11 mm 0.433 in spacing

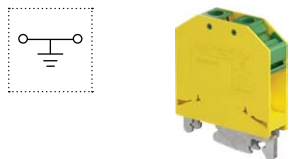
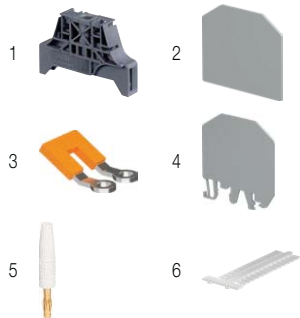

Description

- Stud terminal block for ring lug connection,
- Integrated captive nuts in protective wings provide easy and secured connection,
- Ease your test operations with the 2 built-in nuts with test sockets compatible with DIA 4 mm 0.157 in,
- Universal mounting on symmetrical and asymmetrical rails.

Ordering details

Description	Color	Type	Part Number	Pkg qty	Weight (1 pce) g
Feed-through With 2 studs M4 and captive nuts in wings	Grey <input type="checkbox"/>	RGW6-T-V0	1SNA510124R0000	40	19.04

Main technical data

	IEC	UL	CSA
Lugs	Rigid: Solid/Stranded Flexible with insulated ferrule Gauge	0.1 ... 6 mm ² 22 ... 10 AWG	22 ... 10 AWG
Rated current	41 A	30 A	30 A
Maximum current		30 A	
Rated cross section	6 mm ²	10 AWG	10 AWG
Rated short-time withstand current (1s)	720 A		
Rated voltage	800 V	600 V	600 V
Impulse withstand voltage	8000 V		
Protection	IP10	NEMA 1	

Mounting instructions

Rail		G32, TH 35-7.5, TH 35-15
Nuts		Flat screwdriver Ø 5.5 mm Ø 0.217 in
Tool		0.8 ... 1.2 N.m 7.1 ... 10.6 lb.in
Torque		9.4 mm 0.37 in
Max width of lug		

The connecting capacity data for one Rigid: Solid/Stranded, or one Flexible conductor (when applicable) is a mandatory information required by IEC, UL and CSA standards (Copper conductors). All other data are provided as supplementary information only. For more details, please consult our CB, UL or CSA certificates and technical datasheet available on <http://www.TE.com>

--	--	--	--

Accessories

Description	Color	Type	Part Number	Pkg qty	Weight (1 pce) g
1 End stops	Dark grey <input type="checkbox"/>	BAM4	1SNK900001R0000	50	14.00
2 End sections	Grey <input type="checkbox"/>	E-RGW6	1SNA519004R0000	50	2.65
3 Lateral jumper bars	Orange <input type="checkbox"/>	PC-RG6-2	1SNA519104R0200	25	3.44
3 poles		PC-RG6-3	1SNA519104R0300	20	5.40
4 poles		PC-RG6-4	1SNA519104R0400	15	7.33
7 poles		PC-RG6-7	1SNA519104R0700	5	13.24
10 poles		PC-RG6-10	1SNA519104R1000	5	19.05
4 Circuit separators	Grey <input type="checkbox"/>	CS-RGW-S	1SNA519200R0000	25	4.59
5 Test plugs	White <input type="checkbox"/>	FC4	1SNA167860R0100	10	10.00
6 Terminal block markers	White <input type="checkbox"/>	M-W810PC	1SNA235510R0800	260	0.27
		MG-CPM-01 41096	1SNB041096R0810	1120	0.400

Complete list of accessories is indicated in the terminal block datasheet including end stops. Some accessories such as jumper bars may modify the terminal block's ratings: Complete information available in the accessories section of the catalog.

Ground Ring lug terminal blocks

Description	Color	Type	Part Number	Pkg qty	Weight (1 pce) g
Ground With 2 studs M4 and captive nuts in wings	Green-yellow <input type="checkbox"/>	RGW6-PE-V0	1SNA511024R0500	40	31.76

Technical data valid for copper conductors only.

RGW25-M5 Ring lug terminal blocks

Feed-through - 18 mm 0.709 in spacing

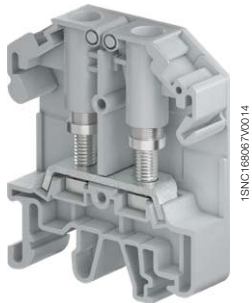
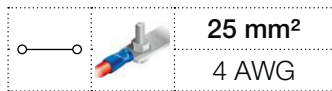

RGW25-M5

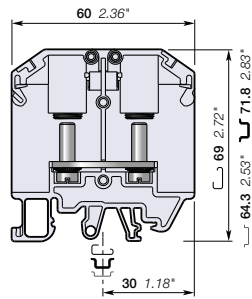

18 mm 0.709 in spacing

Description

- Stud terminal block for ring lug connection,
- Integrated captive nuts in protective wings provide easy and secured connection,
- Universal mounting on symmetrical and asymmetrical rails.

Ordering details

Description	Color	Type	Part Numbers	Pkg qty	Weight (1 pce) g
Feed-through With 2 studs M5 and captive nuts in wings	Grey <input type="checkbox"/>	RGW25-M5-V0	1SNA510005R0000	10	49.10

Main technical data

Lugs	Rigid: Solid/Stranded Flexible with insulated ferrule Gauge	IEC	UL	CSA
		0.1 ... 25 mm²	26 ... 4 AWG	26 ... 4 AWG
Rated current		101 A	85 A	100 A
Maximum current			115 A	
Rated cross section	25 mm²		4 AWG	4 AWG
Rated short-time withstand current (1s)	3000 A			
Rated voltage	800 V		600 V	600 V
Impulse withstand voltage	8000 V			
Protection		IP10	NEMA 1	

Mounting instructions

Rail		G32, TH 35-7.5, TH 35-15
Nuts		Flat screwdriver Ø 5.5 mm Ø 0.217 in
Tool		
Torque		3 ... 3.5 N.m 26.5 ... 31 lb.in
Max width of lug		16.2 mm 0.64 in

The connecting capacity data for one Rigid: Solid/Stranded, or one Flexible conductor (when applicable) is a mandatory information required by IEC, UL and CSA standards (Copper conductors). All other data are provided as supplementary information only. For more details, please consult our CB, UL or CSA certificates and technical datasheet available on <http://www.TE.com>

CE	RoHS	UL US USH CNR	CSA

Accessories

Description	Color	Type	Part Numbers	Pkg qty	Weight (1 pce) g
1 End stops 10 mm 0.394 in	Dark grey <input type="checkbox"/>	BAZH1	1SNK900102R0000	20	24.00
2 End sections 1.4 mm 0.055 in	Grey <input type="checkbox"/>	E-RGW25	1SNA519005R0000	25	0.146
3 Lateral jumper bars 2 poles 101 A (IEC)	Orange <input type="checkbox"/>	PC-RGW25-2	1SNA519106R0200	25	8.81
4 Circuit separators 2 mm 0.079 in	Grey <input type="checkbox"/>	CS-RGW-L	1SNA519201R0000	25	13.72
5 Terminal block markers Blank marker	White <input type="checkbox"/>	M-W1010PC	1SNA235512R1000	200	0.10
		MG-CPM-01 41096	1SNB041096R0810	1120	0.400

Complete list of accessories is indicated in the terminal block datasheet including end stops.

Some accessories such as jumper bars may modify the terminal block's ratings: Complete information available in the accessories section of the catalog.

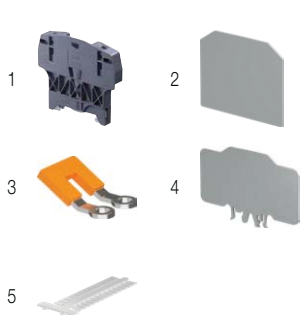

Technical data valid for copper conductors only.

RGW25-M6 Ring lug terminal blocks

Feed-through - 18 mm 0.709 in spacing

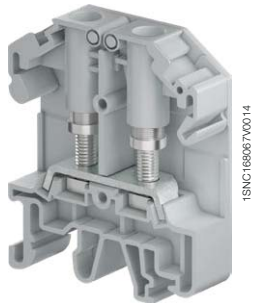

RGW25-M6

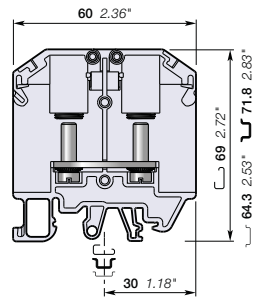

18 mm 0.709 in spacing

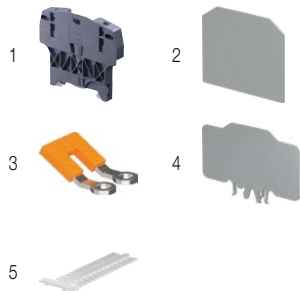

Description

- Stud terminal block for ring lug connection,
- Integrated captive nuts in protective wings provide easy and secured connection,
- Universal mounting on symmetrical and asymmetrical rails.

Ordering details

Description	Color	Type	Part Numbers	Pkg qty	Weight (1 pce) g
Feed-through With 2 studs M6 and captive nuts in wings	Grey <input type="checkbox"/>	RGW25-M6-V0	1SNA510006R0000	10	48.44

Main technical data

Lugs	Rigid: Solid/Stranded Flexible with insulated ferrule Gauge	IEC	UL	CSA
		0.1 ... 25 mm ² 0.1 ... 25 mm ²	26 ... 4 AWG	26 ... 4 AWG
Rated current		101 A	85 A	100 A
Maximum current			115 A	
Rated cross section	25 mm ²		4 AWG	4 AWG
Rated short-time withstand current (1s)	3000 A			
Rated voltage	800 V	600 V	600 V	
Impulse withstand voltage	8000 V			
Protection	IP10	NEMA 1		

Mounting instructions

Rail		G32, TH 35-7.5, TH 35-15
Nuts		Flat screwdriver Ø 5.5 mm Ø 0.217 in
Tool		
Torque		3.2 ... 3.5 N.m 28.3 ... 32.7 lb.in
Max width of lug		16.2 mm 0.64 in

The connecting capacity data for one Rigid: Solid/Stranded, or one Flexible conductor (when applicable) is a mandatory information required by IEC, UL and CSA standards (Copper conductors). All other data are provided as supplementary information only. For more details, please consult our CB, UL or CSA certificates and technical datasheet available on <http://www.TE.com>

--	--	--	--	--	--	--	--	--	--

Accessories

Description	Color	Type	Part Numbers	Pkg qty	Weight (1 pce) g
1 End stops 10 mm 0.394 in	Dark grey <input type="checkbox"/>	BAZH1	1SNK900102R0000	20	24.00
2 End sections 1.4 mm 0.055 in	Grey <input type="checkbox"/>	E-RGW25	1SNA519005R0000	25	0.146
3 Lateral jumper bars 2 poles 101 A (IEC)	Orange <input type="checkbox"/>	PC-RG25-2	1SNA519106R0200	25	8.81
4 Circuit separators 2 mm 0.079 in	Grey <input type="checkbox"/>	CS-RGW-L	1SNA519201R0000	25	13.72
5 Terminal block markers	White <input type="checkbox"/>	M-W1010PC	1SNA235512R1000	200	0.10
		MG-CPM-01 41096	1SNB041096R0810	1120	0.400

Complete list of accessories is indicated in the terminal block datasheet including end stops. Some accessories such as jumper bars may modify the terminal block's ratings: Complete information available in the accessories section of the catalog.

Technical data valid for copper conductors only.

RGW2.5-PE Ring lug terminal blocks

Ground - 10 mm 0.394 in spacing



2.5 mm²

14 AWG

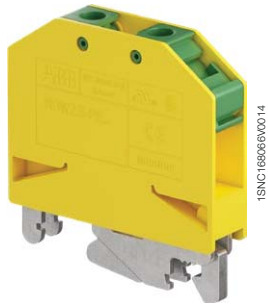

RGW2.5-PE

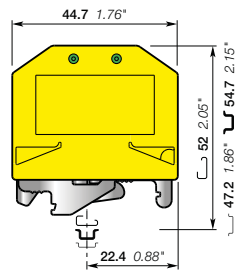

10 mm 0.394 in spacing

Description

- Stud terminal block for ring lug connection,
- Integrated captive nuts in protective wings provide easy and secured connection,
- Universal mounting on symmetrical and asymmetrical rails.

Ordering details

Description	Color	Type	Part Number	Pkg qty	Weight (1 pce) g
Ground With 2 studs M3 and captive nuts in wings	Green-yellow	RGW2.5-PE-V0	1SNA511003R0500	45	28.56

Main technical data

	IEC	UL	CSA
Lugs	Rigid: Solid/Stranded	0.1 ... 2.5 mm ²	26 ... 14 AWG
	Flexible with insulated ferrule Gauge	0.1 ... 2.5 mm ²	26 ... 14 AWG
Rated cross section	2.5 mm ²	14 AWG	14 AWG
Rated short-time withstand current (1s)	300 A		
Protection	IP10	NEMA 1	

Mounting instructions

Rail		G32, TH 35-7.5, TH 35-15
Nuts		Flat screwdriver Ø 4 mm 0.6 ... 0.8 N.m 5.3 ... 7.1 lb.in
Torque		0.6 ... 0.8 N.m 5.3 ... 7.1 lb.in
Rail connection screw		Flat screwdriver Ø 4 mm 0.157 in
Tool		Ø 4 mm 0.157 in
Torque		0.5 ... 0.6 N.m 4.4 ... 5.3 lb.in
Max width of lug		7 mm 0.28 in

The connecting capacity data for one Rigid: Solid/Stranded, or one Flexible conductor (when applicable) is a mandatory information required by IEC, UL and CSA standards (Copper conductors). All other data are provided as supplementary information only. For more details, please consult our CB, UL or CSA certificates and technical datasheet available on <http://www.TE.com>

--	--	--	--

Accessories

Description	Color	Type	Part Number	Pkg qty	Weight (1 pce) g
1 End stops 10 mm 0.394 in	Dark grey	BAM4	1SNK900001R0000	50	14.00
2 Circuit separators 1.5 mm 0.059 in	Grey	CS-RGW-S	1SNA519200R0000	25	4.59
3 Terminal block markers	White	M-W610PC	1SNA235511R0600	360	8.03
		MG-CPM-01 41090	1SNB041090R0510	1960	0.351

Complete list of accessories is indicated in the terminal block datasheet including end stops.

Some accessories such as jumper bars may modify the terminal block's ratings: Complete information available in the accessories section of the catalog.

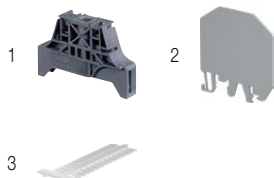

Technical data valid for copper conductors only.

RGW6-PE Ring lug terminal blocks

Ground - 12 mm 0.472 in spacing

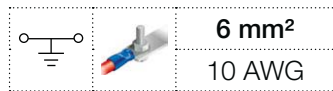

RGW6-PE

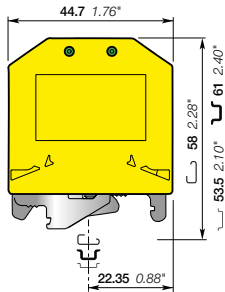

12 mm 0.472 in spacing

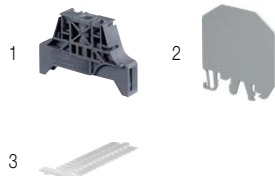

Description

- Stud terminal block for ring lug connection,
- Integrated captive nuts in protective wings provide easy and secured connection,
- Universal mounting on symmetrical and asymmetrical rails.

Ordering details

Description	Color	Type	Part Number	Pkg qty	Weight (1 pce) g
Ground With 2 studs M4 and captive nuts in wings	Green-yellow	RGW6-PE-V0	1SNA511024R0500	40	31.76

Main technical data

		IEC	UL	CSA
Lugs	Rigid: Solid/Stranded	0.1 ... 6 mm ²	22 ... 10 AWG	22 ... 10 AWG
	Flexible with insulated ferrule Gauge	0.1 ... 6 mm ²		
Rated cross section		6 mm ²	10 AWG	10 AWG
Rated short-time withstand current (1s)		720 A		
Protection		IP10	NEMA 1	

Mounting instructions

Rail		G32, TH 35-7.5, TH 35-15
Nuts		Flat screwdriver Ø 5.5 mm Ø 0.217 in
Tool		0.8 ... 1.2 N.m 7.1 ... 10.6 lb.in
Torque		
Rail connection screw		Flat screwdriver Ø 4 mm Ø 0.157 in
Tool		0.5 ... 0.8 N.m 4.4 ... 5.3 lb.in
Torque		
Max width of lug		9.4 mm 0.37 in

The connecting capacity data for one Rigid: Solid/Stranded, or one Flexible conductor (when applicable) is a mandatory information required by IEC, UL and CSA standards (Copper conductors). All other data are provided as supplementary information only. For more details, please consult our CB, UL or CSA certificates and technical datasheet available on <http://www.TE.com>

--	--	--	--	--	--	--	--	--	--

Accessories

Description	Color	Type	Part Number	Pkg qty	Weight (1 pce) g
1 End stops 10 mm 0.394 in	Dark grey	BAM4	1SNK900001R0000	50	14.00
2 Circuit separators 1.5 mm 0.059 in	Grey	CS-RGW-S	1SNA519200R0000	25	4.59
3 Terminal block markers	White	M-W810PC MG-CPM-01 41096	1SNA235510R0800 1SNB041096R0810	260 1120	0.27 0.400

Complete list of accessories is indicated in the terminal block datasheet including end stops.

Some accessories such as jumper bars may modify the terminal block's ratings: Complete information available in the accessories section of the catalog.

Technical data valid for copper conductors only.

RGW Ring lug terminal blocks

Stud technology - Test & measurement

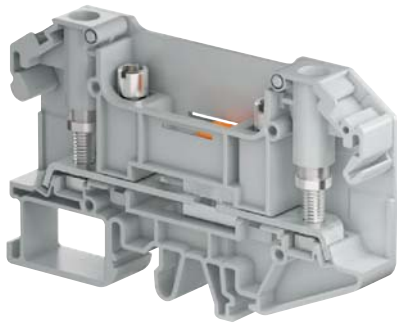

Secure your measurement operations

With its 100% captive wire connection, RGW test & measurement terminal blocks offer a safe and ergonomic test measurement operation.

High performances

- 6 mm² 10 AWG
- 41 A (IEC) 30 A (UL)
- 1000 V (IEC) 600V (UL).

Features

- Test sockets provided on every disconnect blocks RGW6-ST-1...
- Aligned feed-through version RGW6-R1... available for all types of schematics.

Typical measurement configuration

Common point on the transformers

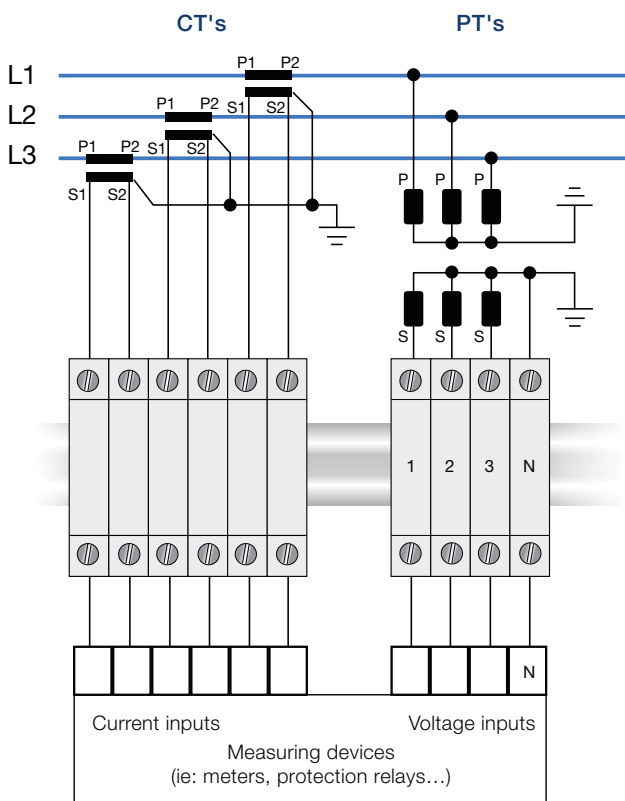

Bill of material

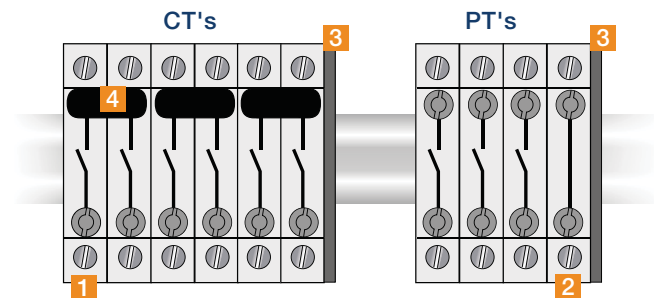

Description	Type	Order code	Qty needed	
			CT's	PT's
1 Terminal block	RGW6-ST-1-V0	1SNA512124R0000	6	3
2 Terminal block	RGW6-R1-V0	1SNA510224R0000	0	1
3 End section	E-RGW6-ST	1SNA519004R0100	1	1
4 Short-circuit plug	SCP12-2	1SNA519300R0200	3	0

RGW6-ST-1 Ring lug terminal blocks

Test disconnect with sliding link - 11 mm 0.433 in spacing

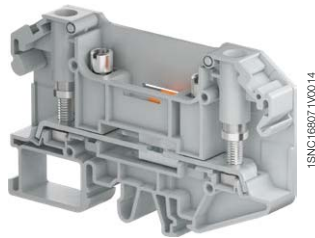
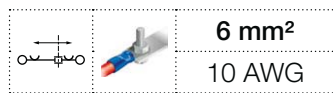

RGW6-ST-1

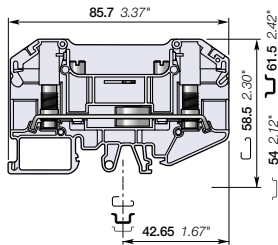

11 mm 0.433 in spacing

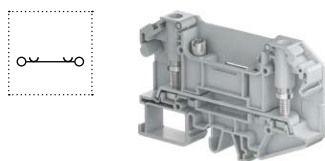
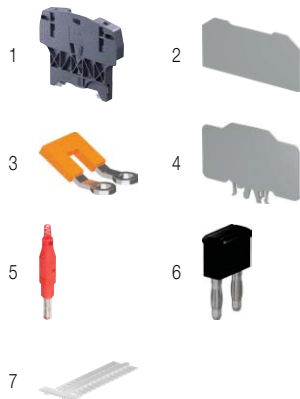

Description

- Stud terminal block for ring lug connection,
- Integrated captive nuts in protective wings provide easy and secured connection,
- Secure your disconnect operations with the disconnect sliding link operated with a standard screwdriver,
- Ease your test operations with the 2 independent built-in test sockets compatible with DIA 4 mm 0.157 in test plugs,
- Universal mounting on symmetrical and asymmetrical rails.

Ordering details

Description	Color	Type	Part Number	Pkg qty	Weight (1 pce) g
Disconnect With 2 studs M4 and captive nuts in wings	Grey <input type="checkbox"/>	RGW6-ST-1-V0	1SNA512124R0000	25	33.66

Main technical data

	IEC	UL	CSA
Lugs	Rigid: Solid/Stranded 0.1 ... 6 mm ² Flexible with insulated ferrule 0.1 ... 6 mm ² Gauge	22 ... 10 AWG	22 ... 10 AWG
Rated current	41 A	30 A	30 A
Maximum current		30 A	
Rated cross section	6 mm ²	10 AWG	10 AWG
Rated voltage	1000 V	600 V	600 V
Rated short-time withstand current (1s)	720 A		
Impulse withstand voltage	8000 V		
Protection	IP10	NEMA 1	

Mounting instructions

Rail		G32, TH 35-7.5, TH 35-15
Nuts		Flat screwdriver Ø 5.5 mm Ø 0.217 in
Tool		0.8 ... 1.2 N.m 7.1 ... 10.6 lb.in
Torque		
Disconnect device		Flat screwdriver Ø 4 mm Ø 0.157 in
Tool		0.5 ... 0.8 N.m 4.4 ... 5.3 lb.in
Torque		
Max width of lug		9.4 mm 0.37 in

The connecting capacity data for one Rigid: Solid/Stranded, or one Flexible conductor (when applicable) is a mandatory information required by IEC, UL and CSA standards (Copper conductors). All other data are provided as supplementary information only. For more details, please consult our CB, UL or CSA certificates and technical datasheet available on <http://www.TE.com>

CE	RoHS	UL US	CSA
CE	RoHS	UL CNR	CSA

Accessories

Description	Color	Type	Part Number	Pkg qty	Weight (1 pce) g	
1 End stops	Dark grey <input checked="" type="checkbox"/>	BAZH1	1SNK900102R0000	20	24.00	
2 End sections	Grey <input type="checkbox"/>	E-RGW6-ST	1SNA519004R0100	25	5.18	
3 Lateral jumper bars	Orange <input checked="" type="checkbox"/>	2 poles	PC-RG6-2	1SNA519104R0200	25	3.44
		3 poles	PC-RG6-3	1SNA519104R0300	20	5.40
		4 poles	PC-RG6-4	1SNA519104R0400	15	7.33
		7 poles	PC-RG6-7	1SNA519104R0700	5	13.24
		10 poles	PC-RG6-10	1SNA519104R1000	5	19.05
4 Circuit separators	Grey <input type="checkbox"/>	CS-RGW-L	1SNA519201R0000	25	13.72	
5 Test plugs	Red <input checked="" type="checkbox"/>	FC4-1	1SNA167927R1000	10	11.00	
6 Short circuit plugs	Black <input checked="" type="checkbox"/>	SCP12-2	1SNA519300R0200	10		
7 Terminal block markers	White <input type="checkbox"/>	M-W810PC	1SNA235510R0800	260	0.27	
		MG-CPM-01 41096	1SNB041096R0810	1120	0.400	

Complete list of accessories is indicated in the terminal block datasheet including end stops.

Some accessories such as jumper bars may modify the terminal block's ratings: Complete information available in the accessories section of the catalog.

Feed-through Ring lug terminal blocks

Description	Color	Type	Part Number	Pkg qty	Weight (1 pce) g
Feed-through With 2 studs M4 and captive nuts in wings	Grey <input type="checkbox"/>	RGW6-R1-V0	1SNA510224R0000	25	36.42

Technical data valid for copper conductors only.

RGW6-R1 Ring lug terminal blocks

Feed-through - 11 mm 0.433 in spacing

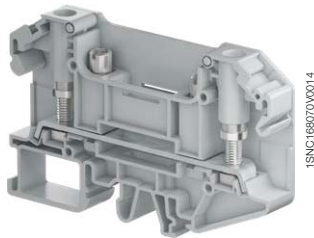
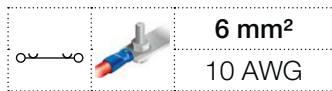

RGW6-R1

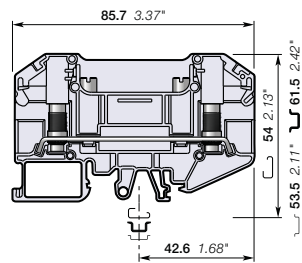

11 mm 0.433 in spacing

Description

- Stud terminal block for ring lug connection,
- Feed-through with the same profile as disconnect terminal block RGW6-ST-1...,
- Integrated captive nuts in protective wings provide easy and secured connection,
- Universal mounting on symmetrical and asymmetrical rails.

Ordering details

Description	Color	Type	Part Number	Pkg qty	Weight (1 pce)
Feed-through With 2 studs M4 and captive nuts in wings	Grey <input type="checkbox"/>	RGW6-R1-V0	1SNA510224R0000	25	36.42

Main technical data

Lugs	Rigid: Solid/Stranded Flexible with insulated ferrule Gauge	IEC	UL	CSA
		0.1 ... 6 mm ² 0.1 ... 6 mm ²	22 ... 10 AWG	22 ... 10 AWG
Rated current		41 A	30 A	30 A
Maximum current			30 A	
Rated cross section		6 mm ²	10 AWG	10 AWG
Rated short-time withstand current (1s)		720 A		
Rated voltage		1000 V	600 V	600 V
Impulse withstand voltage		8000 V		
Protection		IP10	NEMA 1	

Mounting instructions

Rail		G32, TH 35-7.5, TH 35-15
Nuts		Flat screwdriver Ø 5.5 mm Ø 0.217 in
Tool		
Torque		0.8 ... 1.2 N.m 7.1 ... 10.6 lb.in
Max width of lug		9.4 mm 0.37 in

The connecting capacity data for one Rigid: Solid/Stranded, or one Flexible conductor (when applicable) is a mandatory information required by IEC, UL and CSA standards (Copper conductors). All other data are provided as supplementary information only. For more details, please consult our CB, UL or CSA certificates and technical datasheet available on <http://www.TE.com>

CE	RoHS REACH	UL USR CNR	CSA

Accessories

Description	Color	Type	Part Number	Pkg qty	Weight (1 pce)	
1 End stops 10 mm 0.394 in	Dark grey <input type="checkbox"/>	BAZH1	1SNK900102R0000	20	24.00	
2 End sections 1.4 mm 0.055 in	Grey <input type="checkbox"/>	E-RGW6-ST	1SNA519004R0100	25	5.18	
3 Lateral jumper bars	Orange <input type="checkbox"/>	2 poles 41 A (IEC)	PC-RG6-2	1SNA519104R0200	25	3.44
		3 poles 41 A (IEC)	PC-RG6-3	1SNA519104R0300	20	5.40
		4 poles 41 A (IEC)	PC-RG6-4	1SNA519104R0400	15	7.33
		7 poles 41 A (IEC)	PC-RG6-7	1SNA519104R0700	5	13.24
		10 poles 41 A (IEC)	PC-RG6-10	1SNA519104R1000	5	19.05
4 Circuit separators 2 mm 0.079 in	Grey <input type="checkbox"/>	CS-RGW-L	1SNA519201R0000	25	13.72	
5 Test plugs DIA 4 mm 0.157 in IP20	Red <input type="checkbox"/>	FC4-1	1SNA167927R1000	10	11.00	
6 Short circuit plugs	Black <input type="checkbox"/>	SCP12-2	1SNA519300R0200	10		
7 Terminal block markers	White <input type="checkbox"/>	M-W810PC	1SNA235510R0800	260	0.27	
		MG-CPM-01 41096	1SNB041096R0810	1120	0.400	

Complete list of accessories is indicated in the terminal block datasheet including end stops.

Some accessories such as jumper bars may modify the terminal block's ratings: Complete information available in the accessories section of the catalog.

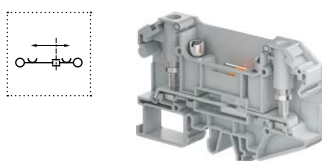
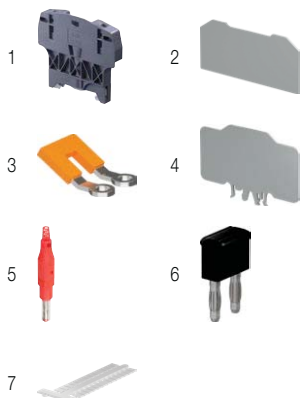

Disconnect Ring lug terminal blocks

Description	Color	Type	Part Number	Pkg qty	Weight (1 pce)
Disconnect With 2 studs M4 and captive nuts in wings	Grey <input type="checkbox"/>	RGW6-ST-1-V0	1SNA512124R0000	25	33.66

Technical data valid for copper conductors only.

End sections

Terminal blocks accessories

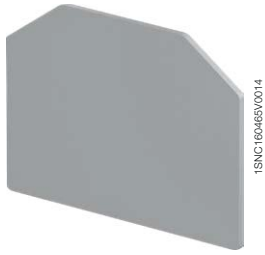

1SNC160466V0014

E-RGW2.5

E-RGW2.5 end sections

Description

– End section compatible with RGW2.5... and RGW2.5-T... terminal block

Ordering details

Description	Color	Type	Part Number	Pkg qty	Weight (1 pce) g
1.2 mm 0.047 in spacing	Grey <input type="checkbox"/>	E-RGW2.5	1SNA519003R0000	25	1.89



1SNC160466V0014

E-RGW6

E-RGW6 end sections

Description

– End section compatible with RGW6... and RGW6-T... terminal block

Ordering details

Description	Color	Type	Part Number	Pkg qty	Weight (1 pce) g
1.4 mm 0.0551 in spacing	Grey <input type="checkbox"/>	E-RGW6	1SNA519004R0000	50	2.65



1SNC160467V0014

E-RGW6-ST

E-RGW6-ST end sections

Description

– End section compatible with RGW6-ST-1... and RGW6-R1... terminal block

Ordering details

Description	Color	Type	Part Number	Pkg qty	Weight (1 pce) g
1.4 mm 0.0551 in spacing	Grey <input type="checkbox"/>	E-RGW6-ST	1SNA519004R0100	25	5.18



1SNC160469V0014

E-RGW25

E-RGW25 end sections

Description

– End section compatible with RGW25... terminal block

Ordering details

Description	Color	Type	Part Number	Pkg qty	Weight (1 pce) g
1.4 mm 0.0551 in spacing	Grey <input type="checkbox"/>	E-RGW25	1SNA519005R0000	25	0.146

Main technical data

Material specifications	Insulating material	Polyamide			
	Flammability	V0			
	NF F 16 101	I2F2			
Ambient temperature min/max	Service IEC 60068-2-1	-40 ... +100 °C	-40 ... +212 °C		
	Storage	-40 ... +100 °C	-40 ... +212 °C		
	Installing	-25 ... +70 °C	-13 ... +167 °C		

All the main technical data provided are "manufacturer" values.

CE	RoHS								
CE	RoHS								

Technical data valid for copper conductors only.

1SNC160035S0201

Jumper bars

Terminal block accessories



PC-RG2.5

1SNC16603652014

Lateral jumper bars

Description

- Lateral jumper bar for ring lug terminal block,
- Allow the connection of consecutive blocks,
- Compatible with RGW terminal block.

Ordering details

Description				Color	Type	Part Number	Pkg qty	Weight (1 pce) g	
Compatible with M3 stud. For blocks RGW2.5...									
9 mm	0.354 in	2 poles	24 A (IEC)	Orange	■	PC-RG2.5-2	1SNA519103R0200	25	3.02
		3 poles	24 A (IEC)			PC-RG2.5-3	1SNA519103R0300	20	4.69
		4 poles	24 A (IEC)			PC-RG2.5-4	1SNA519103R0400	15	6.36
		10 poles	24 A (IEC)			PC-RG2.5-10	1SNA519103R1000	5	16.39
Compatible with M4 stud. For blocks RGW6...									
11 mm	0.433 in	2 poles	41 A (IEC)	Orange	■	PC-RG6-2	1SNA519104R0200	25	3.44
		3 poles	41 A (IEC)			PC-RG6-3	1SNA519104R0300	20	5.40
		4 poles	41 A (IEC)			PC-RG6-4	1SNA519104R0400	15	7.33
		7 poles	41 A (IEC)			PC-RG6-7	1SNA519104R0700	5	13.24
		10 poles	41 A (IEC)			PC-RG6-10	1SNA519104R1000	5	19.05
Compatible with M5 or M6 stud. For blocks RGW25...									
18 mm	0.709 in	2 poles	101 A (IEC)	Orange	■	PC-RG25-2	1SNA519106R0200	25	8.81

Main technical data

Material specifications	Insulating material	Polyamide					
	Flammability	V0					
	NF F 16 101	I2F2					
Ambient temperature min/max	Service IEC 60068-2-1	-40 ... +100 °C	-40 ... +212 °C				
	Storage	-40 ... +100 °C	-40 ... +212 °C				
	Installing	-25 ... +70 °C	-13 ... +167 °C				

All the main technical data provided are "manufacturer" values.

CE	RoHS						
CE	RoHS						

Technical data valid for copper conductors only.

Circuit separators

Terminal blocks accessories

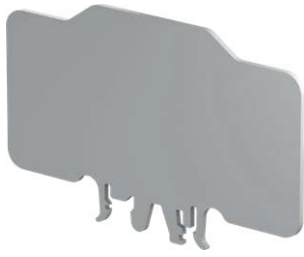

1SNC160471V0014

CS-RGW-L

CS-RGW circuit separators

Description

- Circuit separator for RGW terminal blocks,
- Ease the visual identification of the several circuits within the terminal block assemblies,
- Compatible with all RGW terminal blocks.

Ordering details

Description	Color	Type	Part Number	Pkg qty	Weight (1 pce) g
2 mm 0.078 in spacing	Grey <input type="checkbox"/>	CS-RGW-L	1SNA519201R0000	25	13.72



1SNC160470V0014

CS-RGW-S

CS-RGW circuit separators

Description

- Circuit separator for RGW terminal blocks,
- Ease the visual identification of the several circuits within the terminal block assemblies,
- Compatible with RGW feed-through and ground terminal blocks up to 11 mm 0.433 in spacing.

Ordering details

Description	Color	Type	Part Number	Pkg qty	Weight (1 pce) g
1.5 mm 0.059 in spacing	Grey <input type="checkbox"/>	CS-RGW-S	1SNA519200R0000	25	4.59

Main technical data

Material specifications	Insulating material	Polyamide			
	Flammability	V0			
	NF F 16 101	I2F2			
Ambient temperature min/max	Service IEC 60068-2-1	-40 ... +100 °C	-40 ... +212 °C		
	Storage	-40 ... +100 °C	-40 ... +212 °C		
	Installing	-25 ... +70 °C	-13 ... +167 °C		

All the main technical data provided are "manufacturer" values.

CE	RoHS																		
CE	RoHS																		

Technical data valid for copper conductors only.

1SNC160037S0201

RGW Ring lug terminal blocks





RGW Accessories

Markers and marking systems

Marking systems

Support plates

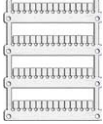
Markers

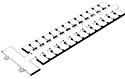
Marking systems		Support plates		Markers	
Type	Part Number	Type	Part Number	Type	Part Number
 MG3 KIT	1SNB419001R0000	 MG2-QTB 991011	1SNB991011R0000	 MG-CPM-01 41090 MG-CPM-01-41096	1SNB041090R0510 1SNB041096R0810
 AMS 600 KIT AMS 250 BASIC KIT	1SNA360000R2400 1SNA360000R2500	 SPRC 26	1SNA360036R0300	 M-W610PC M-W810PC M-W1010PC	1SNA235511R0600 1SNA235510R0800 1SNA235512R1000

1SNC166039S0201



DBL POWER DISTRIBUTION BLOCKS

ENTRELEC Terminal Blocks

DBL power distribution blocks



The clever distribution concept

The exclusive compact and modular design of our power distribution blocks allows easy installation combined with a great flexibility of use.

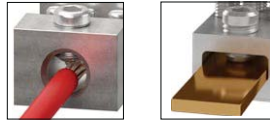

Easy to install

3 configurations in 1 product:

Single pole splitter: split of power main input into several outputs

Multiple poles splitter: interlocking function and ready to use marking kit (L1, L2, L3, N, PE, +, -) delivered with each block

Grouping: of several inputs into 1 output (solar application).

Flexible cover facilitates identification & wiring:

- Reversible, two directions opening, snap-on
- All wiring data's and specifications visible on top.



Space saving

Panel space saving:

Save up to 50 % rail space compare to conventional distribution bars thanks to our modular compact design

1 500 V DC:

Voltage rating adapted to most recent solar inverters requirements.



Increased productivity

Reduced wiring, inventories, hardware and assembly costs:

- Reduce assembly time by 80 % compared to conventional systems.
- Our modular and touch proof concept eliminates the needs for bus bars, isolators, fasteners, protection screens...
- Accept **aluminum & copper** conductors
- 1 product in stock for **3 possible** configurations.

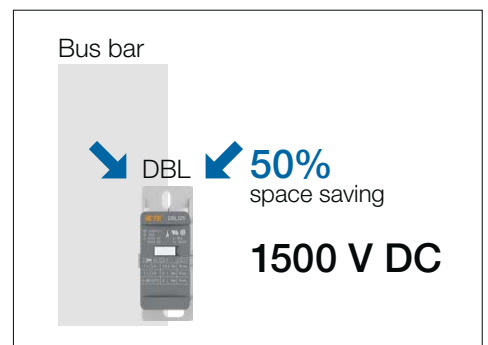
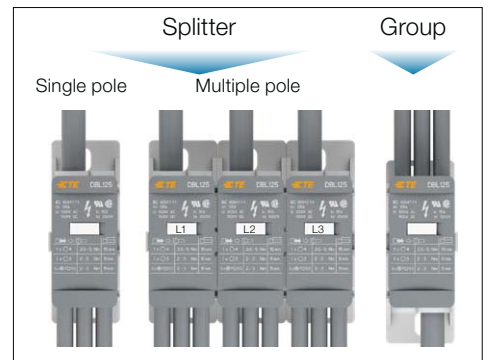

DBL power distribution blocks

1 product, 2 applications

Distributing power in industrial and commercial panels HVAC, machinery, power distribution unit (PDU), commercial panel

3 Phases

DBL80, DBL125, DBL160, DBL175, DBL250, DBL400, DBL125-3, DBL175-C-3

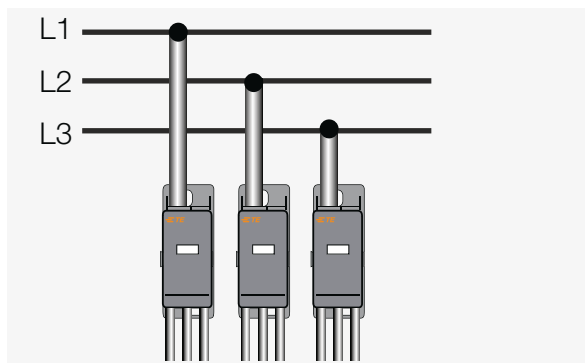

3 Phases for flat conductor

DBL250-F, DBL500-F

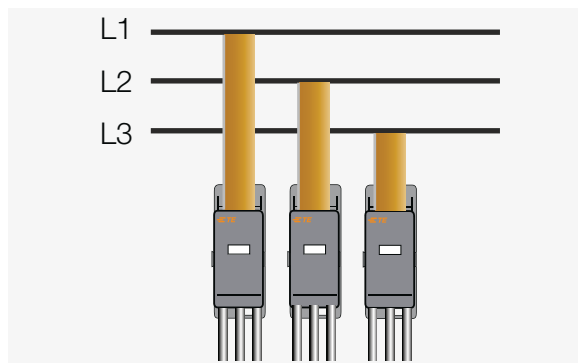

3 Phases with jumpering wire

DBL80, DBL125, DBL160, DBL175, DBL400-PV, DBL125-3, DBL175-C-3 and DBL500-22

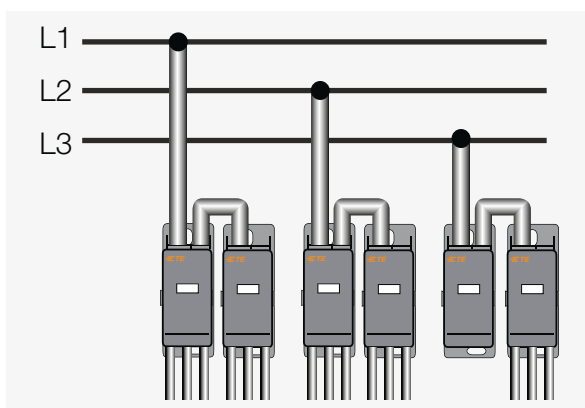

2 in/2 out configuration

DBL500-22

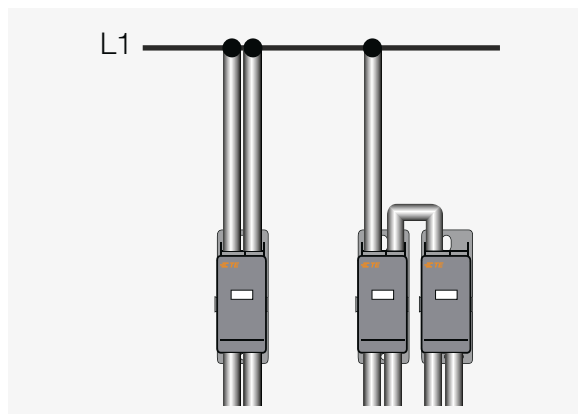

Combining PV strings in one single output PV combiner box, central inverter in a solar power plant

Up to 12 PV strings

DBL80...400

DBL400-PV specifically designed for solar application with 12 inputs of 16 mm².

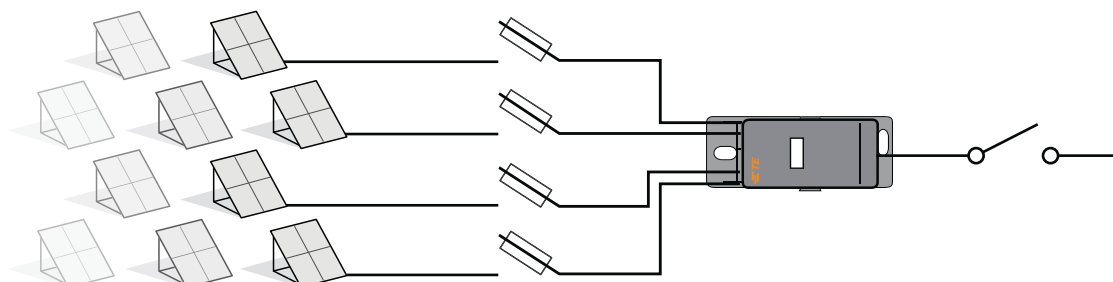

DBL power distribution blocks

Screw clamp technology

Range overview 1000 V AC / 1500 V DC (IEC) - 1000 V (UL), from 80 to 550 A

Single pole

DBL80

7 connections

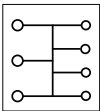

DBL125

8 connections

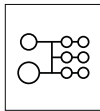

DBL160

8 connections

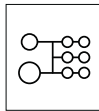

DBL175

12 connections

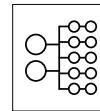

DBL250 and DBL400

12 connections

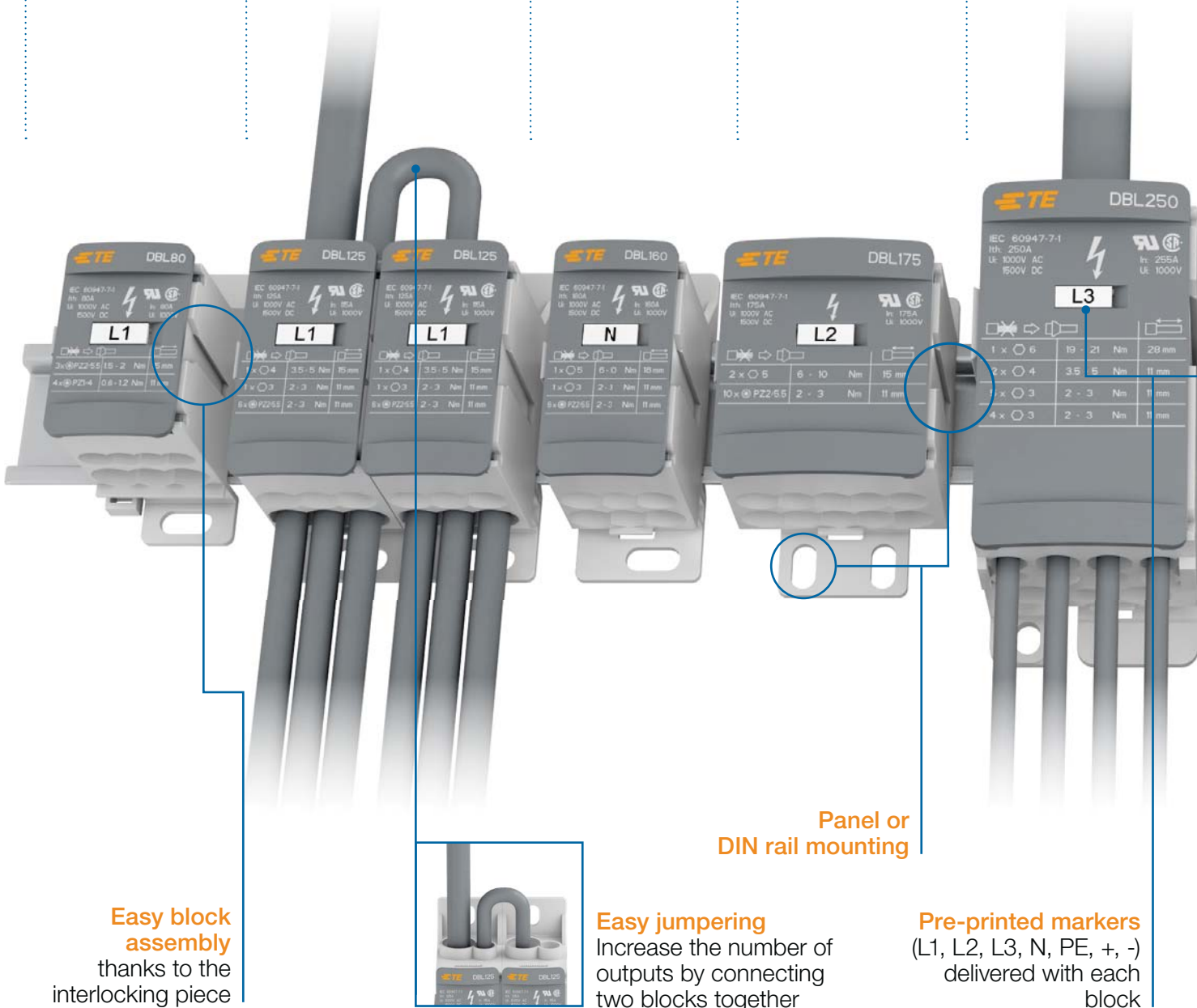
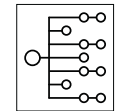

Solar

DBL400-PV
14 connections

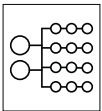

Three poles

DBL125-3 and
DBL175-C-3
8x3 connections

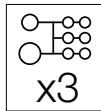

Flat conductor

DBL250-F and
DBL500-F
7 and 12 connections

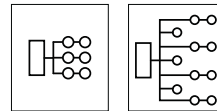

2 in/2 out

DBL500-22
4 connections

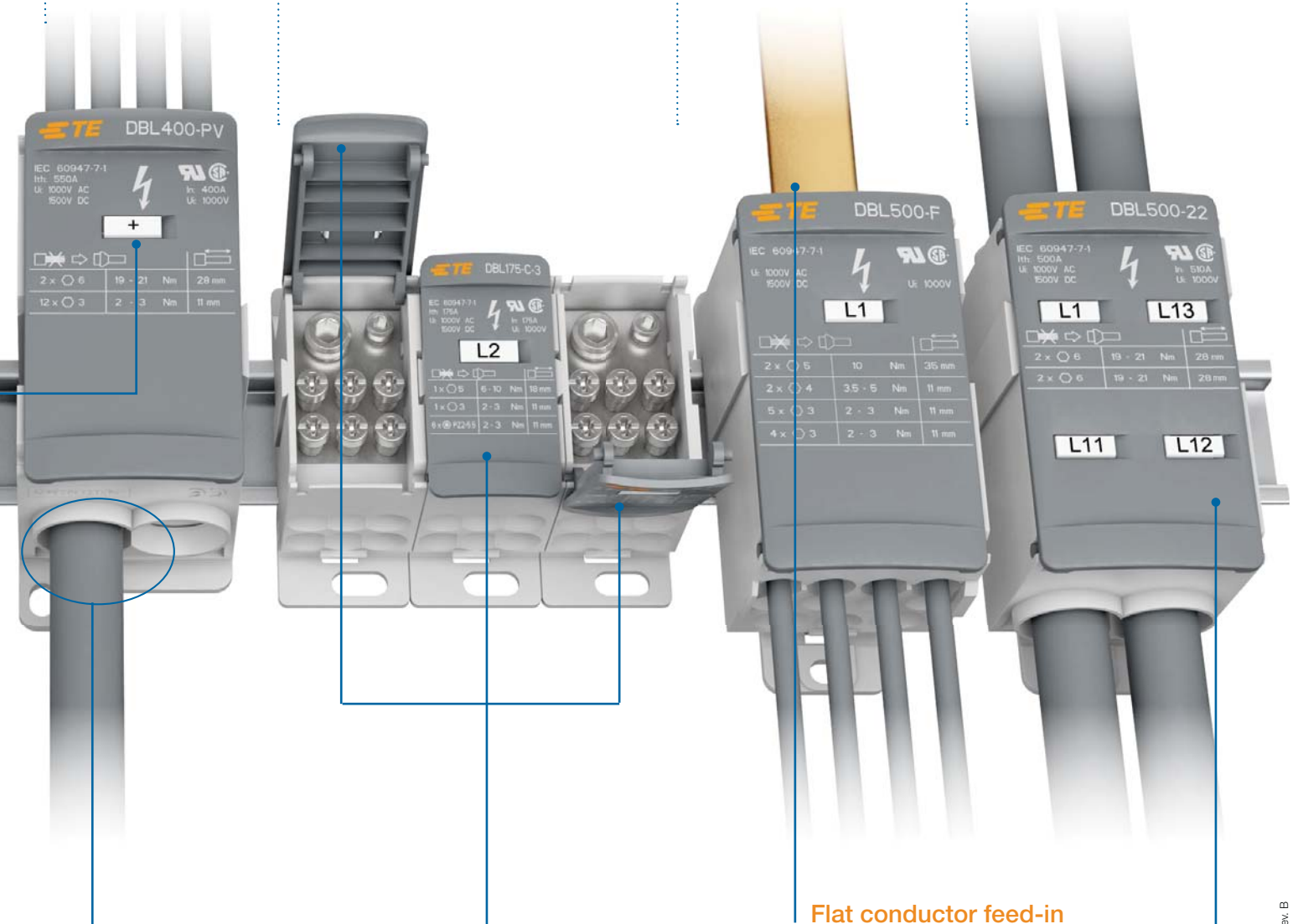
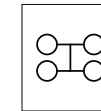

Combining of 12 photovoltaic strings to collect solar energy up to 1500 V DC (IEC), 1000 V DC (UL)

Flexible cover for easy wiring:

- Two directions opening
- Removable & snap-on

Flat conductor feed-in

Main technical data printed on the cover and visible from top

DBL power distribution blocks

Panorama



Input/ Output
Round conductors

Single pole



		Number of connections		7	8	8	12	12	12
Max current		Cross section							
IEC	UL								
Cu 80 A	80 A	16 mm²	4 AWG	DBL80					
Al 63 A	-	16 mm²	-						
Cu 125 A	115 A	35 mm²	2 AWG		DBL125				
Al 100 A	-	35 mm²	-						
Cu 160 A	160 A	70 mm²	2/0 AWG			DBL160			
Al 135 A	-	70 mm²	-						
Cu 175 A	175 A	70 mm²	2/0 AWG				DBL175		
Al 135 A	-	70 mm²	-						
Cu 250 A	255 A	120 mm²	250 Kcmil					DBL250	
Al 200 A	-	120 mm²	-						
Cu 400 A	335 A	185 mm²	400 Kcmil						DBL400
Al 300 A	-	185 mm²	-						
Cu 500 A	510 A	95 mm²	250 Kcmil						
Cu 550 A	400 A	95 mm²	250 Kcmil						

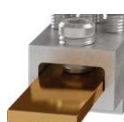

Input:
Flat conductors
Output:
Round conductors

Flat conductors



		Number of connections		7	12
Max current		Max cross section			
IEC	UL				
Cu 250 A	250 A	15.5 x 7.5 mm		DBL250-F	
					DBL500-F Coming soon

Three poles



8x3



8x3



DBL125-3

DBL175-C-3

2 in/2 out



4



DBL500-22

Solar



14



DBL400-PV

DBL80 power distribution blocks

Single pole - 28.4 mm 1.11 in spacing



1SNL166026W0014

DBL80

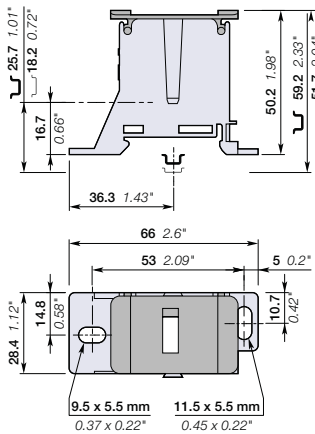

28.4 mm 1.11 in spacing

Mounting instructions

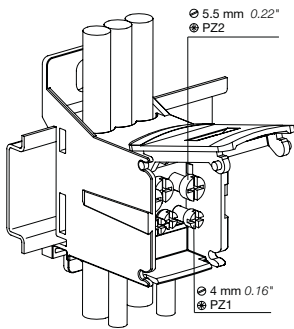

Description

- 3 configurations: distribute unipolar and multipolar power lines, or combine several inputs
- Mount it on Din rail or plate and save up to 50% rail space compared to conventional copper bars
- Reduce the assembly time by 80% by avoiding to use fastening and isolating components
- Increase the number of outputs by using the optional input and connecting two DBL together
- Easy identification with the reversible cover and delivered pre-printed markers L1, L2, L3, N, PE, +, -.

Ordering details

Description	Color	Type	Part Number	Pkg qty	Weight 1 pce g
Feed-through Single pole distribution, 7 connections	Grey	<input type="checkbox"/> DBL80	1SNL308010R0000	1	70

Main technical data

Connecting capacity		IEC	UL
Max current / Cross section	Copper	80 A / 16 mm ²	80 A / 4 AWG
	Aluminium	63 A / 16 mm ²	
Rated voltage		1000 V AC / 1500 V DC	1000 V
Rated impulse voltage		8 kV	
Short-time withstand current (I _{cw} 1s)		1920 A	
Short Circuit Current Rating (SCCR)			100 kA
Rated peak withstand current (I _{pk})		27 kA	
Protection		IP20	NEMA 1

The connecting capacity data for one Rigid/ Solid/Stranded - Flexible conductor (when applicable) is a mandatory information required by IEC, UL and CSA standards (Copper conductors). All other data are provided as supplementary information only. For more details, please consult our CB, UL or CSA certificates and technical datasheet available on <http://www.TE.com>



Mounting & wiring instructions

Rail TH 35-7.5, TH 35-15

Connection Number	Size	Wire type	Wire stripping length	Tool	Torque
Input					
3 x	Ø 6.6 mm Ø 0.26 in	2.5 ... 16 mm ² 14 ... 6 AWG	2.5 ... 16 mm ² 14 ... 4 AWG	15 mm 0.59 in	5.5 mm 0.22 in 1.5 ... 2 Nm 13.5 ... 18 lb.in
Output					
4 x	Ø 4.5 mm Ø 0.18 in	2.5 ... 6 mm ² 14 ... 10 AWG	2.5 ... 6 mm ² 14 ... 10 AWG	11 mm 0.43 in	4 mm 0.16 in 0.8 ... 1.2 Nm 7.2 ... 10.8 lb.in

Not allowed	Flexible without ferrule (IEC V-K & UL: class 5/6)	Flexible with insulated ferrule (IEC V-K & UL: class 5/6)	Rigid Solid (IEC V-U class 1, UL solid)	Rigid Stranded (IEC V-R class 2, UL class B/C)
Flexible without ferrule (IEC V-K & UL: class 5/6)	Flexible with insulated ferrule (IEC V-K & UL: class 5/6)	Rigid Solid (IEC V-U class 1, UL solid)	Rigid Stranded (IEC V-R class 2, UL class B/C)	

⊙ Allen key ⊙ Posidriv - flat screwdriver

Accessories

Description	Color	Type	Part Number	Pkg qty	Weight 1 pce g	
1 End stops	10 mm	Dark grey	BAM4	50	14.00	
	5.2 mm		BAZ1	50	5.30	
	10 mm		BAZH1	20	24.00	
2 Terminal block markers	Blank marker	White	MG-CPM 13 41790	1960	0.236	
	Blank card	Green	MC512PA-GN	1SNK149997R0000	20	10.00
		Blue	MC512PA-BL	1SNK149998R0000	20	10.00
			MC512PA	1SNK149999R0000	20	10.00
			MC512PA	1SNK149002R0000	1	10.00
Pre-printed marker card (L1-L2-L3-N-PE)						

Complete list of accessories is indicated in the terminal block datasheet including end stops. Some accessories such as jumper bars may modify the terminal block's ratings: Complete information available in the accessories section of the catalog.

DBL125 power distribution blocks

Single pole - 28.2 mm 1.11 in spacing



DBL125

1SNK16602/W0014

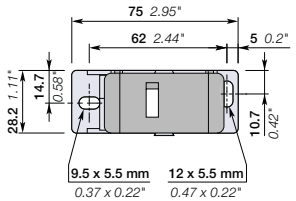
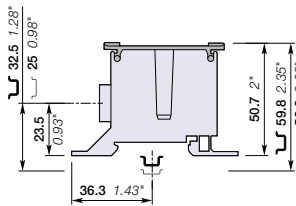

28.2 mm 1.11 in spacing

Mounting instructions

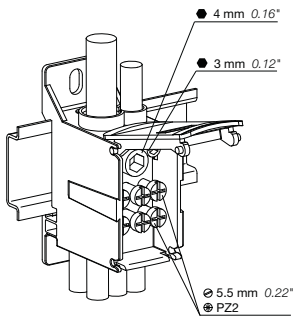

Description

- 3 configurations: distribute unipolar and multipolar power lines, or combine several inputs
- Mount it on Din rail or plate and save up to 50% rail space compared to conventional copper bars
- Reduce the assembly time by 80% by avoiding to use fastening and isolating components
- Increase the number of outputs by using the optional input and connecting two DBL together
- Easy identification with the reversible cover and delivered pre-printed markers L1, L2, L3, N, PE, +, -.

Ordering details

Description	Color	Type	Part Number	Pkg qty	Weight 1 pce g
Feed-through Single pole distribution, 8 connections	Grey	<input type="checkbox"/> DBL125	1SNL312510R0000	1	122

Main technical data

Connecting capacity		IEC	UL
Max current / Cross section	Copper	125 A / 35 mm ²	115 A / 2 AWG
	Aluminium	100 A / 35 mm ²	
Rated voltage		1000 V AC / 1500 V DC	1000 V
Rated impulse voltage		8 kV	
Short-time withstand current (I _{cw} 1s)		4200 A	
Short Circuit Current Rating (SCCR)			100 kA
Rated peak withstand current (I _{pk})		30 kA	
Protection		IP20	NEMA 1

The connecting capacity data for one Rigid/ Solid/Stranded - Flexible conductor (when applicable) is a mandatory information required by IEC, UL and CSA standards (Copper conductors). All other data are provided as supplementary information only. For more details, please consult our CB, UL or CSA certificates and technical datasheet available on <http://www.TE.com>



Mounting & wiring instructions

Rail TH 35-7.5, TH 35-15

Connection Number	Size	Wire type	Wire stripping length	Tool	Torque		
Input	1 x	Ø 9.8 mm Ø 0.39 in	10 ... 35 mm ² 8 ... 2 AWG	10 ... 35 mm ² 8 ... 2 AWG	15 mm 0.59 in	4 mm 0.16 in	3.5 ... 5 Nm 31 ... 44 lb.in
		Output	1 x	Ø 6.8 mm Ø 0.27 in	2.5 ... 16 mm ² 14 ... 6 AWG	6 ... 16 mm ² 10 ... 6 AWG	11 mm 0.43 in
6 x	Ø 6.4 mm Ø 0.25 in			2.5 ... 16 mm ² 14 ... 6 AWG	2.5 ... 16 mm ² 14 ... 6 AWG	11 mm 0.43 in	5.5 mm 0.22 in

When using maximum cable size with insulated ferrules, use a maximum of 2 non-adjacent holes in each row.

Not allowed	Flexible without ferrule (IEC V-K & UL: class 5/6)	Flexible with insulated ferrule (IEC V-K & UL: class 5/6)	Rigid Solid (IEC V-U class 1, UL solid)	Rigid stranded (IEC V-R class 2, UL class B/C)

⊙ Allen key ⊕ Posidriv - flat screwdriver

Accessories

Description	Color	Type	Part Number	Pkg qty	Weight 1 pce g
1 End stops	Dark grey	<input checked="" type="checkbox"/> BAM4	1SNK900001R0000	50	14.00
		<input type="checkbox"/> BAZ1	1SNK900002R0000	50	5.30
		<input type="checkbox"/> BAZH1	1SNK900102R0000	20	24.00
2 Terminal block markers	White	<input type="checkbox"/> MG-CPM 13 41790	1SNB041790R0512	1960	0.236
	Green	<input checked="" type="checkbox"/> MC512PA-GN	1SNK149997R0000	20	10.00
	Blue	<input type="checkbox"/> MC512PA-BL	1SNK149998R0000	20	10.00
	White	<input type="checkbox"/> MC512PA	1SNK149999R0000	20	10.00
	Pre-printed marker card (L1-L2-L3-N-PE)		<input type="checkbox"/> MC512PA	1SNK149002R0000	1

Complete list of accessories is indicated in the terminal block datasheet including end stops. Some accessories such as jumper bars may modify the terminal block's ratings: Complete information available in the accessories section of the catalog.

1SNK16601/3S0201

DBL125-3 power distribution blocks

3x1 pole - 84.6 mm 3.33 in spacing



DBL125-3

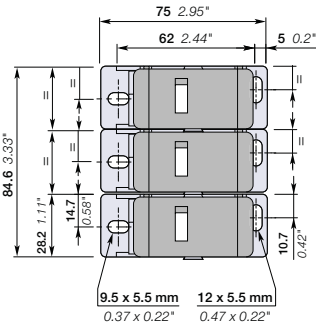
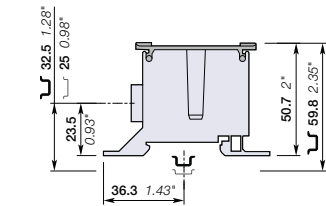

84.6 mm 3.33 in spacing

Mounting instructions

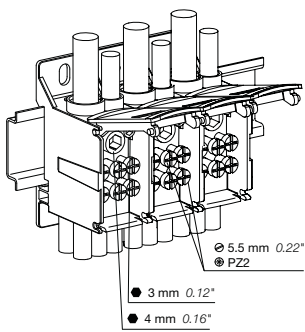

Description

- The usage of three poles distribution block is recommended for L1, L2, L3 applications
- Each pole can be separated from the assembly to align the poles with upstream equipment configuration
- Mount it on Din rail or plate and save up to 50% rail space compared to conventional copper bars
- Reduce the assembly time by 80% by avoiding to use fastening and isolating components
- Easy identification with the reversible cover and delivered pre-printed markers L1, L2, L3, N, PE, +, -.

Ordering details

Description	Color	Type	Part Number	Pkg qty	Weight 1 pce g
Feed-through Three poles distribution block 3x8 connections	Grey	<input type="checkbox"/>	DBL125-3 1SNL312530R0000	1	367

Main technical data

Connecting capacity		IEC	UL
Max current / Cross section	Copper	125 A / 35 mm ²	115 A / 2 AWG
	Aluminium	100 A / 35 mm ²	
Rated voltage		1000 V AC / 1500 V DC	1000 V
Rated impulse voltage		8 kV	
Short-time withstand current (Icw 1s)		4200 A	
Short Circuit Current Rating (SCCR)			
Rated peak withstand current (Ipk)		30 kA	
Protection		IP20	NEMA 1

The connecting capacity data for one Rigid/ Solid/Stranded - Flexible conductor (when applicable) is a mandatory information required by IEC, UL and CSA standards (Copper conductors). All other data are provided as supplementary information only. For more details, please consult our CB, UL or CSA certificates and technical datasheet available on <http://www.TE.com>



Mounting & wiring instructions

Rail TH 35-7.5, TH 35-15

Connection Number by pole	Size	Wire type	Wire stripping length	Tool	Torque
Input	1 x Ø 9.8 mm	10 ... 35 mm ²	10 ... 35 mm ²	15 mm	4 mm 3.5 ... 5 Nm
	Ø 0.39 in	8 ... 2 AWG	8 ... 2 AWG	0.59 in	0.16 in 31 ... 44 lb.in
Output	1 x Ø 6.8 mm	2.5 ... 16 mm ²	6 ... 16 mm ²	11 mm	3 mm 2 ... 3 Nm
	Ø 0.27 in	14 ... 6 AWG	10 ... 6 AWG	0.43 in	0.12 in 18 ... 26.5 lb.in
	6 x Ø 6.4 mm	2.5 ... 16 mm ²	2.5 ... 16 mm ²	11 mm	5.5 mm 2 ... 3 Nm
	Ø 0.25 in	14 ... 6 AWG	14 ... 6 AWG	0.43 in	0.22 in 18 ... 26.5 lb.in

When using maximum cable size with insulated ferrules, use a maximum of 2 non-adjacent holes in each row.

Not allowed	Flexible without ferrule (IEC V-K & UL: class 5/6)	Flexible with insulated ferrule (IEC V-K & UL: class 5/6)	Rigid Solid (IEC V-U class 1, UL solid)	Rigid stranded (IEC V-R class 2, UL class B/C)

⊙ Allen key ⊕ Posidriv - flat screwdriver

Accessories

Description	Color	Type	Part Number	Pkg qty	Weight 1 pce g
1 End stops	10 mm	0.394 in	Dark grey <input checked="" type="checkbox"/> BAM4	1SNK900001R0000	50 14.00
	5.2 mm	0.205 in	BAZ1	1SNK900002R0000	50 5.30
	10 mm	0.394 in	BAZH1	1SNK900102R0000	20 24.00
2 Terminal block markers	Blank marker	White	<input type="checkbox"/> MG-CPM 13 41790	1SNB041790R0512	1960 0.236
	Blank card	Green	<input checked="" type="checkbox"/> MC512PA-GN	1SNK149997R0000	20 10.00
		Blue	<input type="checkbox"/> MC512PA-BL	1SNK149998R0000	20 10.00
		White	<input type="checkbox"/> MC512PA	1SNK149999R0000	20 10.00
		Pre-printed marker card (L1-L2-L3-N-PE)	<input type="checkbox"/> MC512PA	1SNK149002R0000	1 10.00

Complete list of accessories is indicated in the terminal block datasheet including end stops. Some accessories such as jumper bars may modify the terminal block's ratings: Complete information available in the accessories section of the catalog.

DBL160 power distribution blocks

Single pole - 28.2 mm 1.11 in spacing



DBL160

1SNK16602R00014

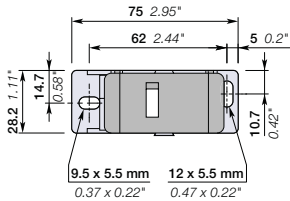
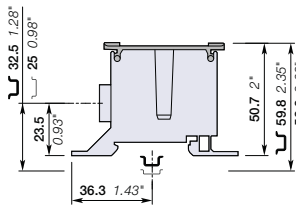

28.2 mm 1.11 in spacing

Mounting instructions

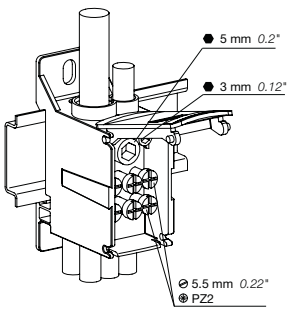

Description

- 3 configurations: distribute unipolar and multipolar power lines, or combine several inputs
- Mount it on Din rail or plate and save up to 50% rail space compared to conventional copper bars
- Reduce the assembly time by 80% by avoiding to use fastening and isolating components
- Increase the number of outputs by using the optional input and connecting two DBL together
- Easy identification with the reversible cover and delivered pre-printed markers L1, L2, L3, N, PE, +, -.

Ordering details

Description	Color	Type	Part Number	Pkg qty	Weight 1 pce g
Feed-through Single pole distribution, 8 connections	Grey	<input type="checkbox"/> DBL160	1SNL316010R0000	1	120

Main technical data

Connecting capacity		IEC	UL
Max current / Cross section	Copper	160 A / 70 mm ²	160 A / 2/0 AWG
	Aluminium	135 A / 70 mm ²	
Rated voltage		1000 V AC / 1500 V DC	1000 V
Rated impulse voltage		8 kV	
Short-time withstand current (I _{cw} 1s)		6000 A	
Short Circuit Current Rating (SCCR)			100 kA
Rated peak withstand current (I _{pk})		30 kA	
Protection		IP10	NEMA 1

The connecting capacity data for one Rigid/ Solid/Stranded - Flexible conductor (when applicable) is a mandatory information required by IEC, UL and CSA standards (Copper conductors). All other data are provided as supplementary information only. For more details, please consult our CB, UL or CSA certificates and technical datasheet available on <http://www.TE.com>



Mounting & wiring instructions

Rail TH 35-7.5, TH 35-15

Connection Number	Size	Wire type	Wire stripping length	Tool	Torque	
Input						
1 x	Ø 11.8 mm Ø 0.46 in	16 ... 50 mm ² 6 ... 1/0 AWG	16 ... 70 mm ² 6 ... 2/0 AWG	18 mm 0.708 in	5 mm 0.20 in	6... 10 Nm 53 ... 88 lb.in
1 x	Ø 6.8 mm Ø 0.27 in	2.5 ... 16 mm ² 14 ... 6 AWG	6 ... 16 mm ² 10 ... 6 AWG	11 mm 0.43 in	3 mm 0.12 in	2 ... 3 Nm 18 ... 26.5 lb.in
6 x	Ø 6.4 mm Ø 0.25 in	2.5 ... 16 mm ² 14 ... 6 AWG	2.5 ... 16 mm ² 14 ... 6 AWG	11 mm 0.43 in	5.5 mm 0.22 in	2 ... 3 Nm 18 ... 26.5 lb.in

When using maximum cable size with insulated ferrules, use a maximum of 2 non-adjacent holes in each row.

Not allowed	Flexible without ferrule (IEC V-K & UL: class 5/6)	Flexible with insulated ferrule (IEC V-K & UL: class 5/6)	Rigid Solid (IEC V-U class 1, UL solid)	Rigid stranded (IEC V-R class 2, UL class B/C)

⊙ Allen key ⊕ Posidriv - flat screwdriver

Accessories

Description	Color	Type	Part Number	Pkg qty	Weight 1 pce g
1 End stops	Dark grey	<input checked="" type="checkbox"/> BAM4	1SNK900001R0000	50	14.00
		<input type="checkbox"/> BAZ1	1SNK900002R0000	50	5.30
		<input type="checkbox"/> BAZH1	1SNK900102R0000	20	24.00
2 Terminal block markers	White	<input type="checkbox"/> MG-CPM 13 41790	1SNB041790R0512	1960	0.236
		<input checked="" type="checkbox"/> MC512PA-GN	1SNK149997R0000	20	10.00
		<input type="checkbox"/> MC512PA-BL	1SNK149998R0000	20	10.00
		<input type="checkbox"/> MC512PA	1SNK149999R0000	20	10.00
		<input type="checkbox"/> MC512PA	1SNK149002R0000	1	10.00
Pre-printed marker card (L1-L2-L3-N-PE)					

Complete list of accessories is indicated in the terminal block datasheet including end stops. Some accessories such as jumper bars may modify the terminal block's ratings: Complete information available in the accessories section of the catalog.

1SNK166014S0201

DBL175 power distribution blocks

Single pole - 46.2 mm 1.82 in spacing



1SNK166029W001-4

DBL175

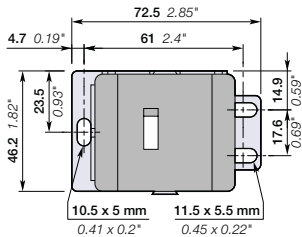
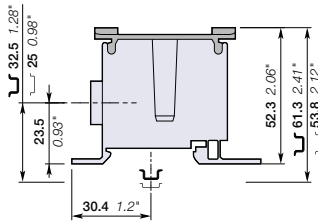

46.2 mm 1.81 in spacing

Mounting instructions

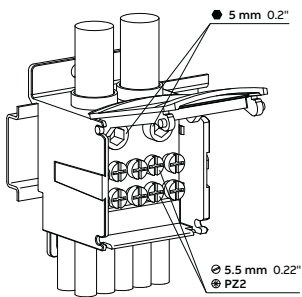

Description

- Reduce the assembly time by 80% by avoiding to use fastening and isolating components
- Mount it on Din rail or plate and save up to 50% rail space compared to conventional copper bars
- Increase the number of outputs by using the optional input and connecting two DBL together, or increase the current rating with two wires, 300 A with 50 mm² wires and 350 A with 2/0 AWG wires
- Easy identification with the reversible cover and delivered pre-printed markers L1, L2, L3, N, PE, +, -.

Ordering details

Description	Color	Type	Part Number	Pkg qty	Weight 1 pce g
Feed-through Single pole distribution, 12 connections	Grey	<input type="checkbox"/> DBL175	1SNL317510R0000	1	200

Main technical data

Connecting capacity		IEC	UL
Max current / Cross section	Copper	175 A / 70 mm ²	175 A / 2/0 AWG
	Aluminium	135 A / 70 mm ²	
Rated voltage		1000 V AC / 1500 V DC	1000 V
Rated impulse voltage		8 kV	
Short-time withstand current (I _{tw} 1s)		6000 A	
Short Circuit Current Rating (SCCR)			100 kA
Rated peak withstand current (I _{pk})		30 kA	
Protection		IP10	NEMA 1

The connecting capacity data for one Rigid: Solid/Stranded - Flexible conductor (when applicable) is a mandatory information required by IEC, UL and CSA standards (Copper conductors). All other data are provided as supplementary information only. For more details, please consult our CB, UL or CSA certificates and technical datasheet available on <http://www.TE.com>



Mounting & wiring instructions

Rail TH 35-7.5, TH 35-15

Connection Number	Size	Wire type	Wire stripping length	Tool	Torque	
Input	2 x	Ø 11.8 mm	10 ... 50 mm ²	10 ... 70 mm ²	15 mm	6... 10 Nm
		Ø 0.46 in	8 ... 1/0 AWG	6 ... 2/0 AWG	0.708 in	53 ... 88 lb.in
Output	10 x	Ø 6.4 mm	2.5 ... 16 mm ²	2.5 ... 16 mm ²	11 mm	2 ... 3 Nm
		Ø 0.25 in	14 ... 6 AWG	14 ... 6 AWG	0.43 in	18 ... 26.5 lb.in

Not allowed	Flexible without ferrule (IEC V-K & UL: class 5/6)	Flexible with insulated ferrule (IEC V-K & UL: class 5/6)	Rigid Solid (IEC V-U class 1, UL solid)	Rigid stranded (IEC V-R class 2, UL class B/C)

⊙ Allen key ⊗ Posidriv - flat screwdriver

Accessories

Description	Color	Type	Part Number	Pkg qty	Weight 1 pce g
1 End stops	10 mm	0.394 in	Dark grey <input checked="" type="checkbox"/> BAM4	1SNK900001R0000	50 14.00
	5.2 mm	0.205 in	BAZ1	1SNK900002R0000	50 5.30
	10 mm	0.394 in	BAZH1	1SNK900102R0000	20 24.00
2 Terminal block markers	Blank marker	White	<input type="checkbox"/> MG-CPM 13 41790	1SNB041790R0512	1960 0.236
	Blank card	Green	<input checked="" type="checkbox"/> MC512PA-GN	1SNK149997R0000	20 10.00
		Blue	<input checked="" type="checkbox"/> MC512PA-BL	1SNK149998R0000	20 10.00
		White	<input type="checkbox"/> MC512PA	1SNK149999R0000	20 10.00
		Pre-printed marker card (L1-L2-L3-N-PE)	<input type="checkbox"/> MC512PA	1SNK149002R0000	1 10.00

Complete list of accessories is indicated in the terminal block datasheet including end stops. Some accessories such as jumper bars may modify the terminal block's ratings: Complete information available in the accessories section of the catalog.

DBL175-C-3 power distribution blocks

3x1 pole - 84.6 mm 3.33 in spacing



DBL175-C-3

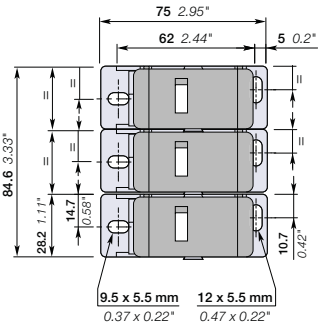
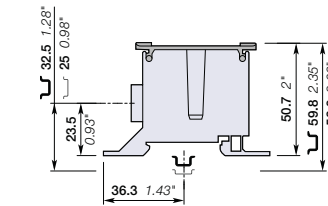

84.6 mm 3.33 in spacing

Mounting instructions

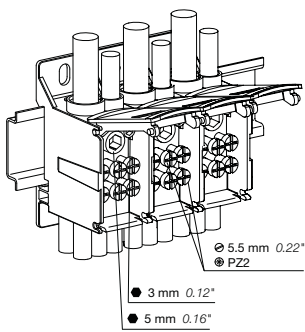

Description

- The usage of three poles distribution block is recommended for L1, L2, L3 applications
- Each pole can be separated from the assembly to align the poles with upstream equipment configuration
- Mount it on Din rail or plate and save up to 50% rail space compared to conventional copper bars
- Reduce the assembly time by 80% by avoiding to use fastening and isolating components
- Easy identification with the reversible cover and delivered pre-printed markers L1, L2, L3, N, PE, +, -.

Ordering details

Description	Color	Type	Part Number	Pkg qty	Weight 1 pce g
Feed-through Three poles distribution block 3x8 connections	Grey	<input type="checkbox"/>	DBL175-C-3 1SNL317531R0000	1	360

Main technical data

Connecting capacity		IEC	UL
Max current / Cross section	Copper	175 A / 70 mm ²	175 A / 2/0 AWG
	Aluminium	135 A / 70 mm ²	
Rated voltage		1000 V AC / 1500 V DC	1000 V
Rated impulse voltage		8 kV	
Short-time withstand current (Icw 1s)		6000 A	
Short Circuit Current Rating (SCCR)			
Rated peak withstand current (Ipk)		30 kA	
Protection		IP10	NEMA 1

The connecting capacity data for one Rigid: Solid/Stranded - Flexible conductor (when applicable) is a mandatory information required by IEC, UL and CSA standards (Copper conductors). All other data are provided as supplementary information only. For more details, please consult our CB, UL or CSA certificates and technical datasheet available on <http://www.TE.com>



Mounting & wiring instructions

Rail TH 35-7.5, TH 35-15

Connection Number by pole	Size	Wire type	Wire stripping length	Tool	Torque	
Input	1 x Ø 11.8 mm	16 ... 50 mm ²	16 ... 70 mm ²	18 mm	5 mm 0.20 in	6... 10 Nm 53 ... 88 lb.in
	Ø 0.46 in	8 ... 1/0 AWG	6 ... 2/0 AWG	0.708 in		
Output	1 x Ø 6.8 mm	2.5 ... 16 mm ²	6 ... 16 mm ²	11 mm	3 mm 0.12 in	2 ... 3 Nm 18 ... 26.5 lb.in
	Ø 0.27 in	14 ... 6 AWG	10 ... 6 AWG	0.43 in		
	6 x Ø 6.4 mm	2.5 ... 16 mm ²	2.5 ... 16 mm ²	11 mm	5.5 mm 0.22 in	2 ... 3 Nm 18 ... 26.5 lb.in
	Ø 0.25 in	14 ... 6 AWG	14 ... 6 AWG	0.43 in		

When using maximum cable size with insulated ferrules, use a maximum of 2 non-adjacent holes in each row.

Not allowed	Flexible without ferrule (IEC V-K & UL: class 5/6)	Flexible with insulated ferrule (IEC V-K & UL: class 5/6)	Rigid Solid (IEC V-U class 1, UL solid)	Rigid stranded (IEC V-R class 2, UL class B/C)

⊙ Allen key ⊕ Posidriv - flat screwdriver

Accessories

Description	Color	Type	Part Number	Pkg qty	Weight 1 pce g
1 End stops	10 mm	0.394 in	Dark grey <input checked="" type="checkbox"/> BAM4	1SNK900001R0000	50 14.00
	5.2 mm	0.205 in	BAZ1	1SNK900002R0000	50 5.30
	10 mm	0.394 in	BAZH1	1SNK900102R0000	20 24.00
2 Terminal block markers	Blank marker	White	<input type="checkbox"/> MG-CPM 13 41790	1SNB041790R0512	1960 0.236
	Blank card	Green	<input checked="" type="checkbox"/> MC512PA-GN	1SNK149997R0000	20 10.00
		Blue	<input type="checkbox"/> MC512PA-BL	1SNK149998R0000	20 10.00
		White	<input type="checkbox"/> MC512PA	1SNK149999R0000	20 10.00
		Pre-printed marker card (L1-L2-L3-N-PE)	<input type="checkbox"/> MC512PA	1SNK149002R0000	1 10.00

Complete list of accessories is indicated in the terminal block datasheet including end stops. Some accessories such as jumper bars may modify the terminal block's ratings: Complete information available in the accessories section of the catalog.

1SNL3166021S0201

DBL250 power distribution blocks

Single pole - 46 mm 1.81 in spacing



DBL250

1SNL1660300014

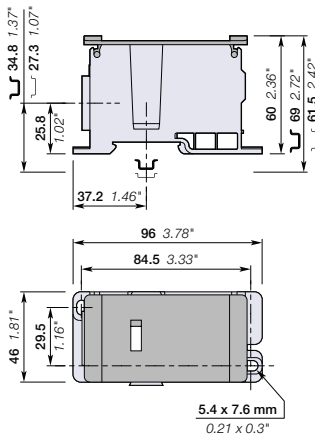

46 mm 1.81 in spacing

Mounting instructions

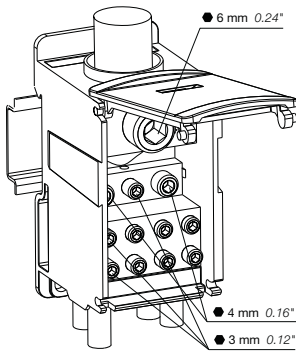

Description

- 3 configurations: distribute unipolar and multipolar power lines, or combine several inputs
- Mount it on Din rail or plate and save up to 50% rail space compared to conventional copper bars
- Reduce the assembly time by 80% by avoiding to use fastening and isolating components
- Easy identification with the reversible cover and delivered pre-printed markers L1, L2, L3, N, PE, +, -.

Ordering details

Description	Color	Type	Part Number	Pkg qty	Weight 1 pce g
Feed-through Single pole distribution, 12 connections	Grey	<input type="checkbox"/> DBL250	1SNL325010R0000	1	439

Main technical data

Connecting capacity		IEC	UL
Max current / Cross section	Copper Aluminium	250 A / 120 mm ² 200 A / 120 mm ²	255 A / 250 Kcmil
Rated voltage		1000 V AC / 1500 V DC	1000 V
Rated impulse voltage		8 kV	
Short-time withstand current (I _{sw} 1s)		11400 A	
Short Circuit Current Rating (SCCR)			100 kA
Rated peak withstand current (I _{pk})		51 kA	
Protection		IP10	NEMA 1

The connecting capacity data for one Rigid / Solid/Stranded - Flexible conductor (when applicable) is a mandatory information required by IEC, UL and CSA standards (Copper conductors). All other data are provided as supplementary information only. For more details, please consult our CB, UL or CSA certificates and technical datasheet available on <http://www.TE.com>



Mounting & wiring instructions

Rail TH 35-7.5, TH 35-15

Connection Number	Size	Wire type	Wire stripping length	Tool	Torque	
Input	1 x Ø 15.3 mm Ø 0.60 in	35 ... 95 mm ² 2 ... 3/0 AWG	35 ... 120 mm ² 2 ... 250 Kcmil	28 mm 1.10 in	6 mm 0.24 in	19 ... 21 Nm 168 ... 185 lb.in
	2 x Ø 8.7 mm Ø 0.34 in	2.5 ... 25 mm ² 14 ... 4 AWG	2.5 ... 35 mm ² 14 ... 2 AWG	11 mm 0.43 in	4 mm 0.16 in	3.5 ... 5 Nm 31 ... 44 lb.in
Output	5 x Ø 6.4 mm Ø 0.25 in	2.5 ... 16 mm ² 14 ... 6 AWG	2.5 ... 16 mm ² 14 ... 6 AWG	11 mm 0.43 in	3 mm 0.12 in	2 ... 3 Nm 18 ... 26.5 lb.in
	4 x Ø 5.7 mm Ø 0.22 in	2.5 ... 10 mm ² 14 ... 8 AWG	2.5 ... 10 mm ² 14 ... 8 AWG	11 mm 0.43 in	3 mm 0.12 in	2 ... 3 Nm 18 ... 26.5 lb.in

When using maximum cable size with insulated ferrules, use a maximum of 2 non-adjacent holes in each row.

Not allowed	Flexible without ferrule (IEC V-K & UL: class 5/6)	Flexible with insulated ferrule (IEC V-K & UL: class 5/6)	Rigid Solid (IEC V-U class 1, UL solid)	Rigid stranded (IEC V-R class 2, UL class B/C)

⊙ Allen key ⊕ Posidriv - flat screwdriver

Accessories

Description	Color	Type	Part Number	Pkg qty	Weight 1 pce g
1 End stops	10 mm	0.394 in	Dark grey <input type="checkbox"/> BAM4	1SNK900001R0000	50 14.00
	5.2 mm	0.205 in	<input type="checkbox"/> BAZ1	1SNK900002R0000	50 5.30
	10 mm	0.394 in	<input type="checkbox"/> BAZH1	1SNK900102R0000	20 24.00
2 Terminal block markers	Blank marker	White	<input type="checkbox"/> MG-CPM 13 41790	1SNB041790R0512	1960 0.236
	Blank card	Green	<input type="checkbox"/> MC512PA-GN	1SNK149997R0000	20 10.00
		Blue	<input type="checkbox"/> MC512PA-BL	1SNK149998R0000	20 10.00
		White	<input type="checkbox"/> MC512PA	1SNK149999R0000	20 10.00
		Pre-printed marker card (L1-L2-L3-N-PE)	<input type="checkbox"/> MC512PA	1SNK149002R0000	1 10.00

Complete list of accessories is indicated in the terminal block datasheet including end stops. Some accessories such as jumper bars may modify the terminal block's ratings: Complete information available in the accessories section of the catalog.

DBL250-F power distribution blocks

Single pole - Flat entry - 29 mm 1.14 in spacing



DBL250-F

1SNK1660250014

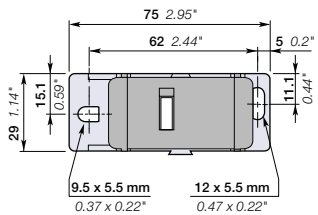
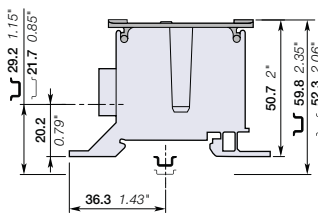

29 mm 1.14 in spacing

Mounting instructions

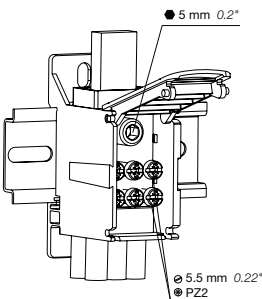

Description

- Suitable for distributing power from flat conductors: flexible or solid bars
- Mount it on Din rail or plate and save up to 50% rail space compared to conventional copper bars
- Reduce the assembly time by 80% by avoiding to use fastening and isolating components
- Easy identification with the reversible cover and delivered pre-printed markers L1, L2, L3, N, PE, +, -.

Ordering details

Description	Color	Type	Part Number	Pkg qty	Weight 1 pce g
Feed-through Single pole distribution - Flat entry, 7 connections	Grey	<input type="checkbox"/> DBL250-F	1SNL325060R0000	1	119

Main technical data

Connecting capacity		IEC	UL
Max current / Cross section	Flexible busbar	250 A / 6 x 15.5 x 0.8 mm	250 A / 6 x 15.5 x 0.8 mm
	Rigid busbar	208 A / 12 x 4 mm	160 A / 12 x 4 mm
Rated voltage		1000 V AC / 1500 V DC	1000 V
Rated impulse voltage		8 kV	
Short-time withstand current (Icw 1s)		11400 A	
Short Circuit Current Rating (SCCR)			Please consult us
Rated peak withstand current (Ipk)		22.8 kA	
Protection		IP20	NEMA 1

The connecting capacity data for one Rigid/Solid/Stranded - Flexible conductor (when applicable) is a mandatory information required by IEC, UL and CSA standards (Copper conductors). All other data are provided as supplementary information only. For more details, please consult our CB, UL or CSA certificates and technical datasheet available on <http://www.TE.com>

CE
 RoHS
 USR
 CSA
 EAC

Mounting & wiring instructions

Connection Number	Size	Wire type	Wire stripping length	Tool	Torque	
Input 1 x	15.5 x 7.5 mm 0.59 x 0.28 in	12 x 4 mm	3 x 9 x 0.8 mm 6 x 15.5 x 0.8 mm	15 mm 0.59 in	5 mm 0.20 in	13.5 Nm 120 lb.in
		12 x 4 mm	2.5 ... 16 mm ² 14 ... 6 AWG	11 mm 0.43 in	5.5 mm 0.22 in	2 ... 3 Nm 18 ... 26.5 lb.in
Output 6 x	Ø 6.6 mm Ø 0.26 in	2.5 ... 16 mm ² 14 ... 6 AWG	2.5 ... 16 mm ² 14 ... 6 AWG	11 mm 0.43 in	5.5 mm 0.22 in	2 ... 3 Nm 18 ... 26.5 lb.in
		12 x 4 mm	2.5 ... 16 mm ² 14 ... 6 AWG	11 mm 0.43 in	5.5 mm 0.22 in	2 ... 3 Nm 18 ... 26.5 lb.in

When using maximum cable size with insulated ferrules, use a maximum of 2 non-adjacent holes in each row.

Not allowed	Flexible with insulated ferrule (IEC V-K & UL: class 5/6)	Rigid Solid (IEC V-U class 1, UL solid)	Rigid stranded (IEC V-R class 2, UL class B/C)	Solid busbar	Flexible busbar
Flexible without ferrule (IEC V-K & UL: class 5/6)	Flexible with insulated ferrule (IEC V-K & UL: class 5/6)	Rigid Solid (IEC V-U class 1, UL solid)	Rigid stranded (IEC V-R class 2, UL class B/C)	Solid busbar	Flexible busbar

Allen key
 Posidriv - flat screwdriver

Accessories

Description	Color	Type	Part Number	Pkg qty	Weight 1 pce g
1 End stops	Dark grey	BAM4	1SNK900001R0000	50	14.00
		BAZ1	1SNK900002R0000	50	5.30
		BAZH1	1SNK900102R0000	20	24.00
2 Terminal block markers	White	MG-CPM 13 41790	1SNB041790R0512	1960	0.236
		MC512PA-GN	1SNK149997R0000	20	10.00
		MC512PA-BL	1SNK149998R0000	20	10.00
		MC512PA	1SNK149999R0000	20	10.00
		MC512PA	1SNK149002R0000	1	10.00
Pre-printed marker card (L1-L2-L3-N-PE)					

Complete list of accessories is indicated in the terminal block datasheet including end stops. Some accessories such as jumper bars may modify the terminal block's ratings: Complete information available in the accessories section of the catalog.

1SNK1660250014

DBL400 power distribution blocks

Single pole - 46 mm 1.81 in spacing



DBL400

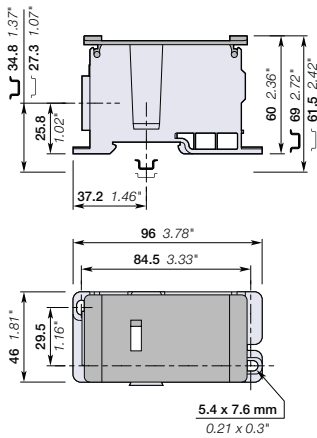

46 mm 1.81 in spacing

Mounting instructions

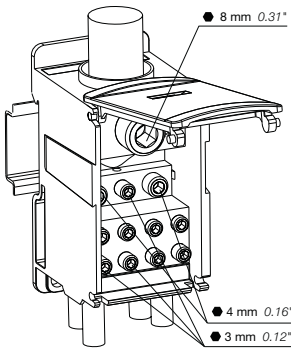

Description

- 3 configurations: distribute unipolar and multipolar power lines, or combine several inputs
- Mount it on Din rail or plate and save up to 50% rail space compared to conventional copper bars
- Reduce the assembly time by 80% by avoiding to use fastening and isolating components
- Easy identification with the reversible cover and delivered pre-printed markers L1, L2, L3, N, PE, +, -.

Ordering details

Description	Color	Type	Part Number	Pkg qty	Weight 1 pce g
Feed-through Single pole distribution, 12 connections	Grey	<input type="checkbox"/> DBL400	1SNL340010R0000	1	425

Main technical data

Connecting capacity		IEC	UL
Max current / Cross section	Copper Aluminium	400 A / 185 mm ² 300 A / 185 mm ²	335 A / 400 Kcmil
Rated voltage		1000 V AC / 1500 V DC	1000 V
Rated impulse voltage		8 kV	
Short-time withstand current (I _{sw} 1s)		18000 A	
Short Circuit Current Rating (SCCR)			100 kA
Rated peak withstand current (I _{pk})		51 kA	
Protection		IP10	NEMA 1

The connecting capacity data for one Rigid / Solid/Stranded - Flexible conductor (when applicable) is a mandatory information required by IEC, UL and CSA standards (Copper conductors). All other data are provided as supplementary information only. For more details, please consult our CB, UL or CSA certificates and technical datasheet available on <http://www.TE.com>



Mounting & wiring instructions

Rail TH 35-7.5, TH 35-15

Connection Number	Size	Wire type	Wire stripping length	Tool	Torque	
Input						
1 x	Ø 18.8 mm Ø 0.74 in	95 ... 150 mm ² 3/0 ... 300 Kcmil	95 ... 185 mm ² 3/0 ... 400 Kcmil	28 mm 1.10 in	8 mm 0.31 in	25 Nm 221 lb.in
2 x	Ø 8.7 mm Ø 0.34 in	2.5 ... 25 mm ² 14 ... 4 AWG	2.5 ... 35 mm ² 14 ... 2 AWG	11 mm 0.43 in	4 mm 0.16 in	3.5 ... 5 Nm 31 ... 44 lb.in
Output						
5 x	Ø 6.4 mm Ø 0.25 in	2.5 ... 16 mm ² 14 ... 6 AWG	2.5 ... 16 mm ² 14 ... 6 AWG	11 mm 0.43 in	3 mm 0.12 in	2 ... 3 Nm 18 ... 26.5 lb.in
4 x	Ø 5.7 mm Ø 0.22 in	2.5 ... 10 mm ² 14 ... 8 AWG	2.5 ... 10 mm ² 14 ... 8 AWG	11 mm 0.43 in	3 mm 0.12 in	2 ... 3 Nm 18 ... 26.5 lb.in

When using maximum cable size with insulated ferrules, use a maximum of 2 non-adjacent holes in each row.

Not allowed	Flexible without ferrule (IEC V-K & UL: class 5/6)	Flexible with insulated ferrule (IEC V-K & UL: class 5/6)	Rigid Solid (IEC V-U class 1, UL solid)	Rigid stranded (IEC V-R class 2, UL class B/C)

⊙ Allen key ⊕ Posidriv - flat screwdriver

Accessories

Description	Color	Type	Part Number	Pkg qty	Weight 1 pce g
1 End stops	10 mm	0.394 in	Dark grey <input checked="" type="checkbox"/> BAM4	1SNK900001R0000	50 14.00
	5.2 mm	0.205 in	<input type="checkbox"/> BAZ1	1SNK900002R0000	50 5.30
	10 mm	0.394 in	<input type="checkbox"/> BAZH1	1SNK900102R0000	20 24.00
2 Terminal block markers	Blank marker	White	<input type="checkbox"/> MG-CPM 13 41790	1SNB041790R0512	1960 0.236
	Blank card	Green	<input checked="" type="checkbox"/> MC512PA-GN	1SNK149997R0000	20 10.00
		Blue	<input type="checkbox"/> MC512PA-BL	1SNK149998R0000	20 10.00
		White	<input type="checkbox"/> MC512PA	1SNK149999R0000	20 10.00
		Pre-printed marker card (L1-L2-L3-N-PE)	<input type="checkbox"/> MC512PA	1SNK149002R0000	1 10.00

Complete list of accessories is indicated in the terminal block datasheet including end stops. Some accessories such as jumper bars may modify the terminal block's ratings: Complete information available in the accessories section of the catalog.

DBL400-PV power distribution blocks

Single pole - 46 mm 1.81 in spacing



1SNK166024S021

DBL400-PV

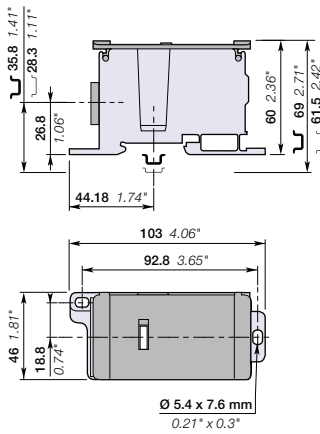

46 mm 1.81 in spacing

Mounting instructions

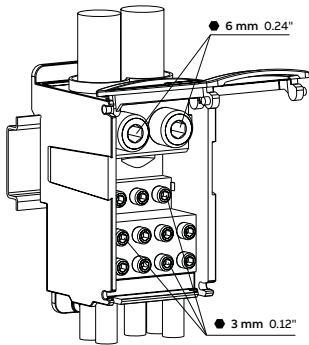

Description

- Suitable for solar application with the possibility to combine 12 photovoltaic strings
- Mount it on Din rail or plate and save up to 50% rail space compared to conventional copper bars
- Reduce the assembly time by 80% by avoiding to use fastening and isolating components
- Increase the number of outputs by using the optional input and connecting two DBL together
- Easy identification with the reversible cover and delivered pre-printed markers L1, L2, L3, N, PE, +, -.

Ordering details

Description	Color	Type	Part Number	Pkg qty	Weight 1 pce g
Feed-through Single pole distribution, 14 connections	Grey	<input type="checkbox"/> DBL400-PV	1SNL340011R0000	1	202

Main technical data

Connecting capacity	IEC	UL
Max current / Cross section	Copper 550 A / (2x) 95 mm ²	400 A / (2x) 250 Kcmil
Rated voltage	1000 V AC / 1500 V DC	1000 V
Rated impulse voltage	8 kV	
Short-time withstand current (Icw 1s)	22800 A	
Short Circuit Current Rating (SCCR)		Please consult us
Rated peak withstand current (Ipk)	47.88 kA	
Protection	IP10	NEMA 1

The connecting capacity data for one Rigid/ Solid/Stranded - Flexible conductor (when applicable) is a mandatory information required by IEC, UL and CSA standards (Copper conductors). All other data are provided as supplementary information only. For more details, please consult our CB, UL or CSA certificates and technical datasheet available on <http://www.TE.com>



Mounting & wiring instructions

Rail TH 35-7.5, TH 35-15

Connection Number	Size	Wire type	Wire stripping length	Tool	Torque
Input					
2 x	Ø 15,5 mm Ø 0.59 in	25 ... 95 mm ² 4 ... 3/0 AWG	25 ... 120 mm ² 4 ... 250 Kcmil	28 mm 1.1 in	6 mm 0.24 in
19 ... 21 Nm 168 ... 185 lb.in					
Output					
12 x	Ø 6.6 mm Ø 0.26 in	2.5 ... 16 mm ² 14 ... 6 AWG	2.5 ... 16 mm ² 14 ... 6 AWG	11 mm 0.43 in	3 mm 0.19 in
2 ... 3 Nm 18 ... 26.5 lb.in					

Not allowed	Flexible without ferrule (IEC V-K & UL: class 5/6)	Flexible with insulated ferrule (IEC V-K & UL: class 5/6)	Rigid Solid (IEC V-U class 1, UL solid)	Rigid stranded (IEC V-R class 2, UL class B/C)

⊙ Allen key ⊙ Posidriv - flat screwdriver

Accessories

Description	Color	Type	Part Number	Pkg qty	Weight 1 pce g	
1 End stops	10 mm	Dark grey	BAM4	50	14.00	
	5.2 mm		BAZ1	50	5.30	
	10 mm		BAZH1	20	24.00	
2 Terminal block markers	Blank marker	White	MG-CPM 13 41790	1960	0.236	
	Blank card	Green	MC512PA-GN	1SNK149997R0000	20	10.00
		Blue	MC512PA-BL	1SNK149998R0000	20	10.00
			MC512PA	1SNK149999R0000	20	10.00
			MC512PA	1SNK149002R0000	1	10.00
Pre-printed marker card (L1-L2-L3-N-PE)						

Complete list of accessories is indicated in the terminal block datasheet including end stops. Some accessories such as jumper bars may modify the terminal block's ratings: Complete information available in the accessories section of the catalog.

1SNK166024S021

DBL500-22 Power Distribution Blocks

Single pole - 46 mm 1.81 in spacing



DBL500-22

1SNL850001R0000

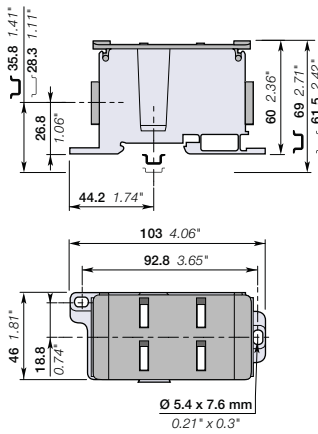

46 mm 1.81 in spacing

Mounting instructions

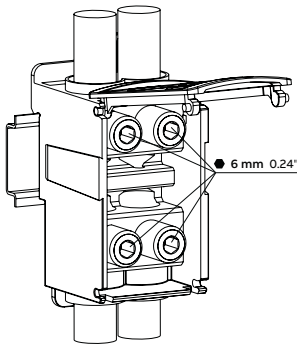

Description

- Suitable for distributing or connecting main power lines with 2 inputs and 2 outputs
- Mount it on Din rail or plate and save up to 50% rail space compared to conventional copper bars
- Reduce the assembly time by 80% by avoiding to use fastening and isolating components
- Increase the number of outputs by using the second input and connecting two DBL together
- Easy identification with the reversible cover and delivered pre-printed markers L1, L2, L3, N, PE, +, -.

Ordering details

Description	Color	Type	Part Number	Pkg qty	Weight 1 pce g
Feed-through Single pole distribution, 4 connections	Grey	<input type="checkbox"/>	DBL500-22	1SNL850001R0000	1 224

Main technical data

Connecting capacity	IEC	UL	
Max current / Cross section	Copper	500 A / (2x) 95 mm ²	510 A / (2x) 250 Kcmil
Rated voltage	1000 V AC / 1500 V DC	1000 V	
Rated impulse voltage	8 kV		
Short-time withstand current (Icw 1s)	22800 A		
Short Circuit Current Rating (SCCR)		Please consult us	
Rated peak withstand current (Ipk)	47.88 kA		
Protection	IP10	NEMA 1	

The connecting capacity data for one Rigid/ Solid/Stranded - Flexible conductor (when applicable) is a mandatory information required by IEC, UL and CSA standards (Copper conductors). All other data are provided as supplementary information only. For more details, please consult our CB, UL or CSA certificates and technical datasheet available on <http://www.TE.com>



Mounting & wiring instructions

Rail TH 35-7.5, TH 35-15

Connection Number	Size	Wire type	Wire stripping length	Tool	Torque
Input					
2 x	Ø 15.5 mm Ø 0.61 in	25 ... 95 mm ² 4 ... 3/0 AWG	25 ... 120 mm ² 4 ... 250 Kcmil	28 mm 1.1 in	6 mm 0.24 in
Output					
2 x	Ø 15.5 mm Ø 0.61 in	25 ... 95 mm ² 4 ... 3/0 AWG	25 ... 120 mm ² 4 ... 250 Kcmil	28 mm 1.1 in	6 mm 0.24 in

Not allowed	Flexible without ferrule (IEC V-K & UL: class 5/6)	Flexible with insulated ferrule (IEC V-K & UL: class 5/6)	Rigid Solid (IEC V-U class 1, UL solid)	Rigid stranded (IEC V-R class 2, UL class B/C)

⊙ Allen key ⊙ Posidriv - flat screwdriver

Accessories

Description	Color	Type	Part Number	Pkg qty	Weight 1 pce g		
1 End Stops	10 mm	0.394 in	Dark Grey	BAM4	1SNK900001R0000	50 14.00	
	5.2 mm	0.205 in		BAZ1	1SNK900002R0000	50 5.30	
	10 mm	0.394 in		BAZH1	1SNK900102R0000	20 24.00	
2 Terminal Block Markers	Blank marker		White	<input type="checkbox"/>	MG-CPM 13 41790	1SNB041790R0512	1960 0.236
	Blank card		Green	<input checked="" type="checkbox"/>	MC512PA-GN	1SNK149997R0000	20 10.00
			Blue	<input checked="" type="checkbox"/>	MC512PA-BL	1SNK149998R0000	20 10.00
			White	<input type="checkbox"/>	MC512PA	1SNK149999R0000	20 10.00
					MC512PA	1SNK149002R0000	1 10.00
	Pre-printed marker card (L1-L2-L3-N-PE)						

Complete list of accessories is indicated in the terminal block datasheet including end stops. Some accessories such as jumper bars may modify the terminal block's ratings: Complete information available in the accessories section of the catalog.

Index

Part Number/Type classification

Part Number	Type	Page
1SNB		
1SNB041790R0512	MG-CPM 13 41790	8
1SNK		
1SNK149002R0000	MC512PA	8
1SNK149997R0000	MC512PA-GN	8
1SNK149998R0000	MC512PA-BL	8
1SNK149999R0000	MC512PA	8
1SNK900001R0000	BAM4	8
1SNK900002R0000	BAZ1	8
1SNK900102R0000	BAZH1	8
1SNL		
1SNL308010R0000	DBL80	8
1SNL312510R0000	DBL125	9
1SNL312530R0000	DBL125-3	10
1SNL316010R0000	DBL160	11
1SNL317510R0000	DBL175	12
1SNL317531R0000	DBL175-C-3	13
1SNL325010R0000	DBL250	14
1SNL325060R0000	DBL250-F	15
1SNL340010R0000	DBL400	16
1SNL340011R0000	DBL400-PV	17
1SNL850001R0000	DBL500-22	18

Type	Part Number	Page
B		
BAM4	1SNK900001R0000	8
BAZ1	1SNK900002R0000	8
BAZH1	1SNK900102R0000	8
D		
DBL125	1SNL312510R0000	9
DBL125-3	1SNL312530R0000	10
DBL160	1SNL316010R0000	11
DBL175	1SNL317510R0000	12
DBL175-C-3	1SNL317531R0000	13
DBL250	1SNL325010R0000	14
DBL250-F	1SNL325060R0000	15
DBL400	1SNL340010R0000	16
DBL400-PV	1SNL340011R0000	17
DBL500-22	1SNL850001R0000	18
DBL80	1SNL308010R0000	8
M		
MC512PA	1SNK149002R0000	8
MC512PA	1SNK149999R0000	8
MC512PA-BL	1SNK149998R0000	8
MC512PA-GN	1SNK149997R0000	8
MG-CPM 13 41790	1SNB041790R0512	8



ESSAILEC® TEST BLOCKS

ENTRELEC Terminal Blocks

ESSAILEC® test blocks allow to safely and easily perform test operations such as current and voltage measurement, monitoring, injection, repair or replacement of meters and protective relays installed in secondary circuits of current and voltage transformers or sensors.

ESSAILEC® test blocks

Overview	1/ 3	1
Current and voltage sensors application	2/ 9	2
Test principles - ESSAILEC® RJ45	10	
ESSAILEC® RJ45 sockets for current and voltage sensors	14	
Current transformers application	3/ 15	3
Test principles - ESSAILEC® RJ45	16	
ESSAILEC® sockets for Current Transformers	22	
ESSAILEC® pre-wired plugs for Current Transformers	24	
ESSAILEC® universal adaptor with Ø 4mm outputs	25	
ESSAILEC® customized plugs	26	4
Voltage transformers application	4/ 29	5
Make before break	30	
Break before make	36	
Closed contact	42	
Independent circuits	48	
Pre-wired plugs	49	
Customized plugs	51	6
Protection lids and covers	5/ 55	7
Multicircuits	6/ 56	
Mounting instructions	7/ 57	8
Mounting instructions for coding	58	
Outer dimensions, mounting instructions	60	
Index	8/ 64	



ESSAILEC® test blocks allow to safely and easily perform test operations such as current and voltage measurement, monitoring, injection, repair or replacement of meters and protective relays installed in secondary circuits of current and voltage transformers or sensors.



Continuous operation

Easy plug & play solution

ESSAILEC® allows a simultaneous test of 1 to 4 circuits thanks to the combination of a plug and a socket.

Fast test operation

Thanks to make before break principle, the current transformers short circuiting is automatically performed (no cursor or switch element to operate manually). Current testing without cutting the energy supply.



Safety and protection

Operator's safety

IP20 protection for the socket and IP40 with the cover. Sealing option available to prevent unauthorized access.

Error free systems

Coding system on plugs & sockets prevent from risks of mixing between various circuits. Protection against reverse plug insertion.

Unitary traceability

Engraved on insulating body.



Easy to install

Multiple choice of mounting

5 possibilities to install ESSAILEC® on front, within the panel or on a plate.

Various choice of wiring technologies

ESSAILEC® offers several connection types: ring tongue, screw clamp, quick-connect and RJ45, to allow different wire terminations and connections up to 10 mm².

Features and benefits

ESSAILEC® is especially designed to fit the electricity utilities requirements for safe and reliable testing. The test operations can be made without any circuit break and without opening the panel door.

ESSAILEC® is approved by major utilities and successfully implemented for years in worldwide electricity production, transport and distribution networks.

ESSAILEC® operation principle

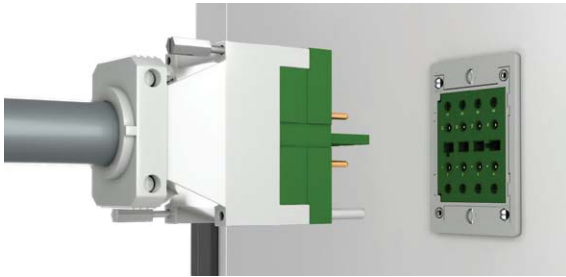

ESSAILEC® is based on a plug & play operation solution. It is composed of a socket and a test plug. The socket is installed in the circuit and wired to the device to be tested during its installation or servicing (protection relay in switchboard or meters). The plug is connected to the test set and allows measurement or signal injection.

Socket design

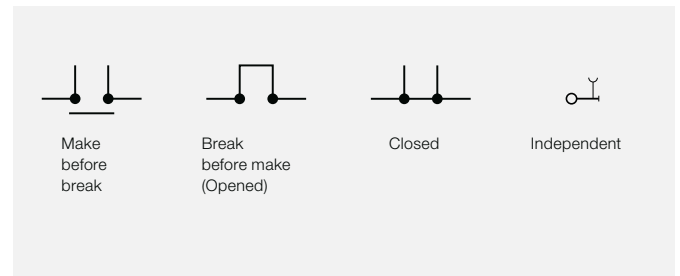

The sockets are available in the following designs:

- Socket with "Make before break" contact design, available in the current, voltage, and RJ45 ranges
- Socket with "Break before make" (opened) contact design, available in voltage application
- Socket with "Closed" contact design, available in voltage application
- Socket with "4 independent circuits" for voltage application.

Safety & protection



Color coding

Prevent from risks of mixing between various circuits.
Color coding: green for current applications, grey / orange / blue for voltage applications.



IP20



IP40



Seal

Operator's safety

Front protection IP20 for the socket and IP40 with the protective lid.
The protective lid is equipped with a sealing option to prevent unauthorized access.

Locking mechanism

Secure the plug on the socket.
No risk of unplugging during test operations.



Error free systems thanks to coding pins

Up to 6 possible combinations to allocate test plug with its appropriate socket for circuit differentiation.



Unitary traceability

The socket integrates a permanent tracking number engraved on insulating body.



Protection against reverse plug insertion

Socket and plug integrate a special plastic shape preventing the circuit polarities reversal.

Features and benefits

Easy to install

Multiple choices of socket mounting

Mounting on panel: front or base mounting



Flush mounting Half-base mounting Base mounting

Mounting within the panel.



TH35 rail mounting Rack mounting

Various choices of wiring technologies

ESSAILEC® offers several connection types (according to the mounting selected): ring tongue, screw clamp, quick-connect and RJ45, to allow different wire terminations and connections up to 10 mm².

Refer to sockets panorama page for more details.

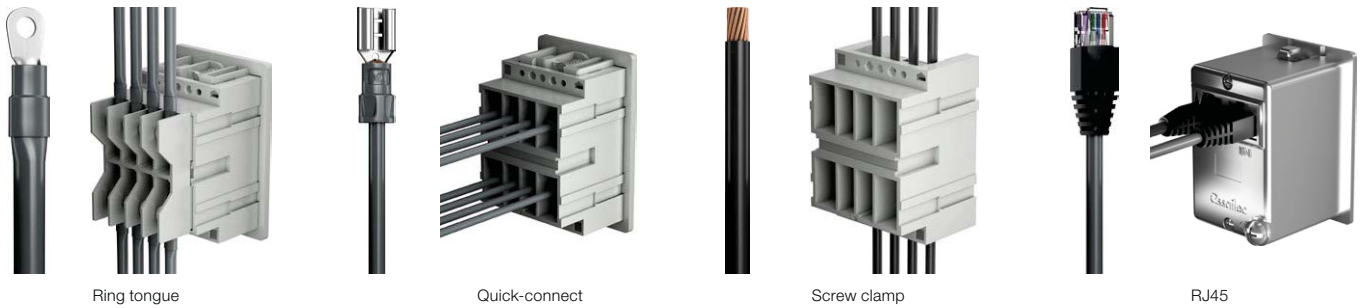

Ring tongue Quick-connect Screw clamp RJ45

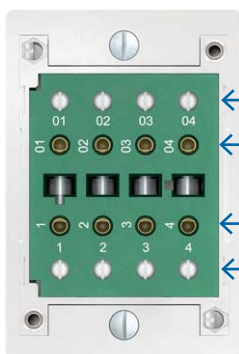

Easy circuit identification

- 01, 02, 03, 04: equipment side.
- Premarked block in two directions to allow convenient reading whatever the mounting sense.
- 1, 2, 3, 4: transformers side.

Plug

The plug is connected to the test equipment by means of test plugs. Plugs are supplied in various configurations, either prewired or ready to be customized.

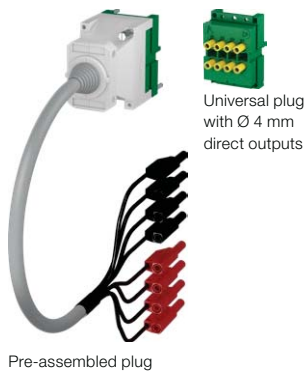

2x4 poles plugs (8 contact pins)

Allow testing of 4 current or voltage circuits. Available in different colors (green, grey, orange, blue).



4 poles plugs (4 contact pins)

Allow testing of 4 voltage circuits. Available in different colors (grey, orange, blue).



1 pole plugs (2 contacts pins)

Allow testing of 1 current or voltage circuit. Available in different colors (red for current applications or grey for voltage applications).



Plugs for customization

In order to provide more flexibility to the end-users ESSAILEC® plugs can be customized according to the targeted application (see customized plugs catalog page).

Protection

Lid or Cover provide dust protection (IP40) and prevent unauthorized access thanks to their embedded sealing option.

Lid and cover with electrical continuity, are necessary compatible with opened contacts sockets (Break before make).

Thanks to their inner pins and linking bars they ensure the circuits continuity.



Sockets panorama

Contact type	Mounting	Connection	For current and voltage sensors	For current transformers	For voltage transformers			
					Grey coding (standard)	Blue coding (polarity)	Orange coding (trip)	
Make before break 	Flush	Ring-tongue	-	CC-E-VA	TC-E-VA	PC-E-VA	-	
			-	CC-E-VA-6.6	TC-E-VA-2.2	PC-E-VA-8.8	-	
		-	CC-E-VA-R2-6.6	TC-E-VA-R2-2.2	-	-		
		RJ45	TC-E-RJ45-INF	-	-	-		
			Quick connect	-	-	TC-E-C5A-2.2	-	-
	Half-base	Ring-tongue	-	CC-D-VA	TC-D-VA	PC-D-VA	-	
	Base/Half-base	Screw clamp	-	-	TC-DS-VL	PC-DS-VL	-	
	Base	Screw clamp	-	CC-S-INF-VL-6.6	TC-S-INF-VL-2.2	-	-	
	TH35	Screw clamp	-	CC-TH35-VL-6.6	TC-TH35-VL	-	-	
	Rack	Ring-tongue	-	CC-R-VA	-	-	-	
Reverse	Ring-tongue	-	CC-I-VA-2	-	-	-		
Break before make Opened contact 	Flush	Ring-tongue	-	-	TO-E-VA	PO-E-VA	DEO-E-VA	
			-	-	TO-E-VA-12.12	-	-	
	Half-base	Ring-tongue	-	-	TO-D-VA	PO-D-VA	DEO-D-VA	
	Base/Half-base	Screw clamp	-	-	TO-DS-VL	PO-DS-VL	-	
	Base	Screw clamp	-	-	TO-S-INF-VL-12.12	-	-	
Reverse	Ring-tongue	-	-	TO-I-VA-2	-	-		
Closed contact 	Flush	Ring-tongue	-	-	TF-E-VA	PF-E-VA	-	
	Half-base	Ring-tongue	-	-	TF-D-VA	PF-D-VA	DEF-D-VA	
	Base/Half-base	Screw clamp	-	-	TF-DS-VL	PF-DS-VL	-	
Independent circuits 	Base	Screw clamp	-	-	TT4-S-VL-INF	-	-	

Socket designation

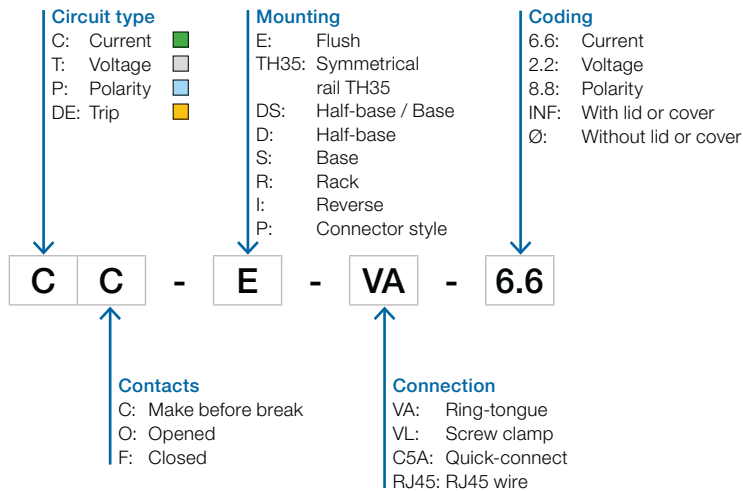

Current and voltage sensors application

Make before break

Test principles - ESSAILEC® RJ45	10
ESSAILEC® RJ45 sockets for current and voltage sensors	14

Current and voltage sensors application

Make before break test principle - Measurement with ESSAILEC® RJ45 test plug

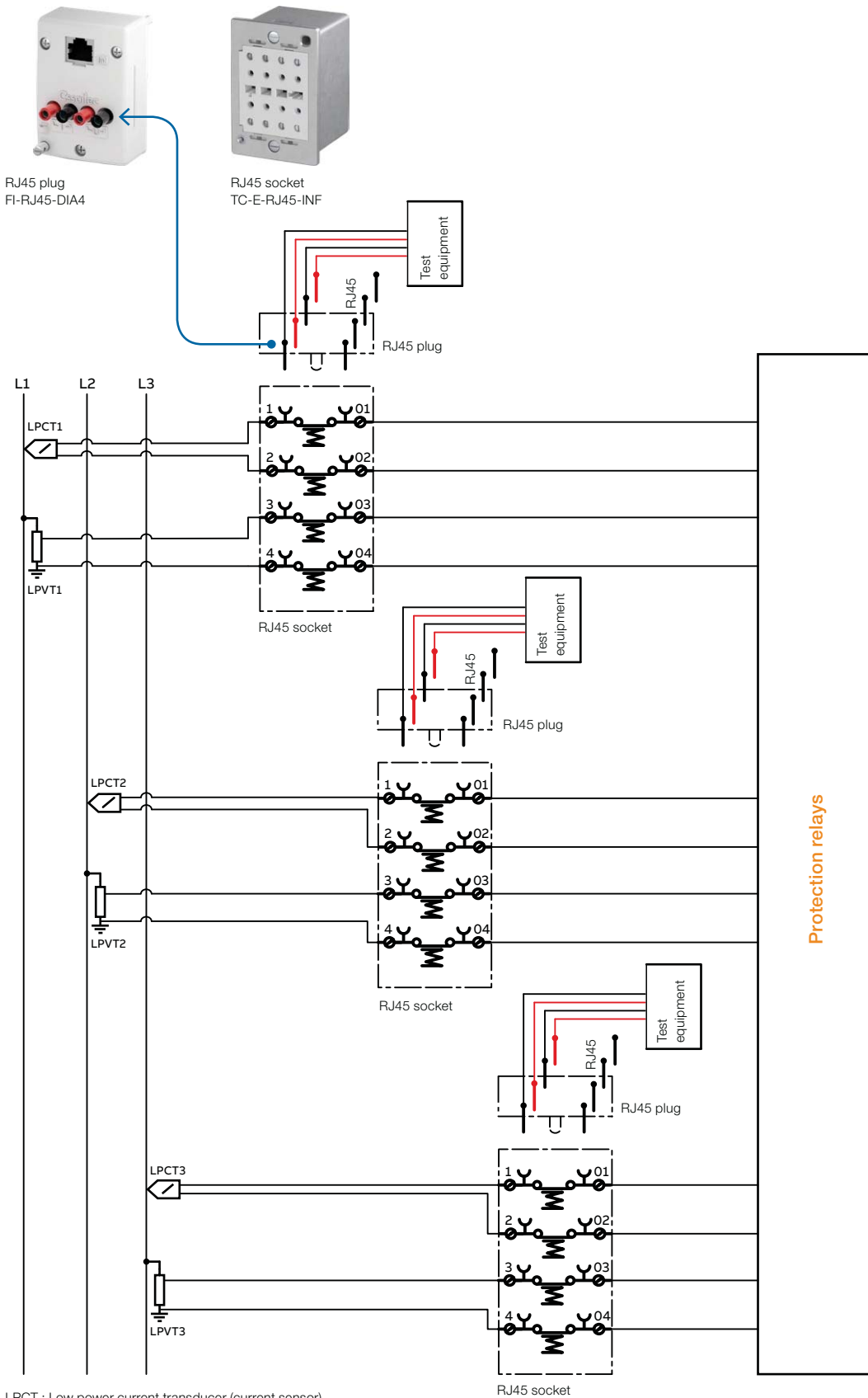

LPCT : Low power current transducer (current sensor)
 LPVT: Low power voltage transducer (voltage sensor)

Protection relays

15NC1693/0045/0201

Make before break base - Injection with ESSAILEC® RJ45 test plug

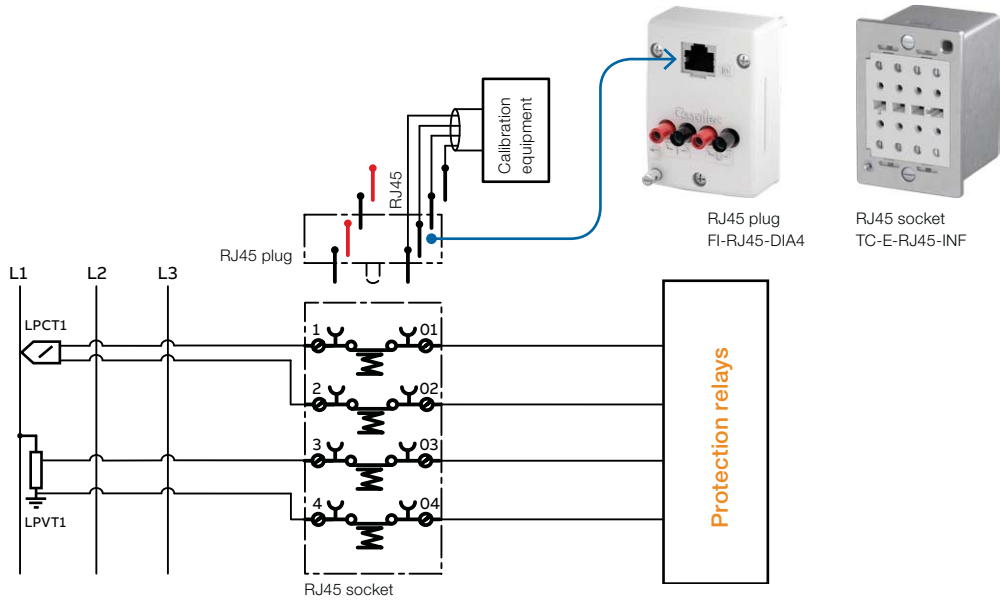

LPCT : Low power current transducer (current sensor)
 LPVT: Low power voltage transducer (voltage sensor)

Current and voltage sensors application

Make before break test principle - With ESSAILEC® RJ45 test plug

Applications

- Injection
- Equipment replacement

1. Normal service



1.1 ESSAILEC® RJ45 sockets have a shielded body. The 3 sockets are required to cover the testing operation on the 3 main lines (L1, L2, L3).

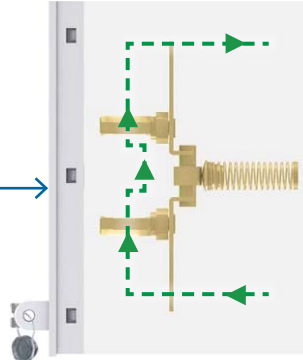

1.2 The lid is installed on the socket and can be sealed to prevent unauthorized access. The socket **circuits are closed** and signals flow from current and voltage sensors to protection relay.

2. Lid removal



The lid is removed.

4.2 Test phase: Injection

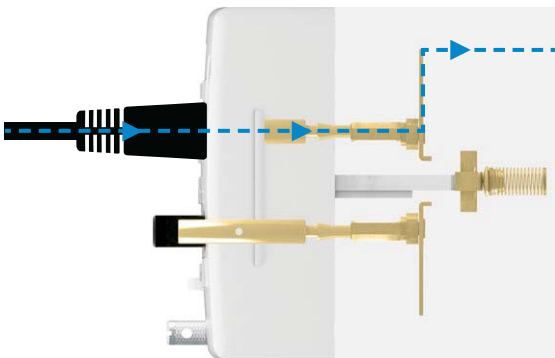

The RJ45 plug allows to perform **injection**. Plug a **RJ45 connector** on to the ESSAILEC® RJ45 plug to test the protection relay through the integrated RJ45 input.

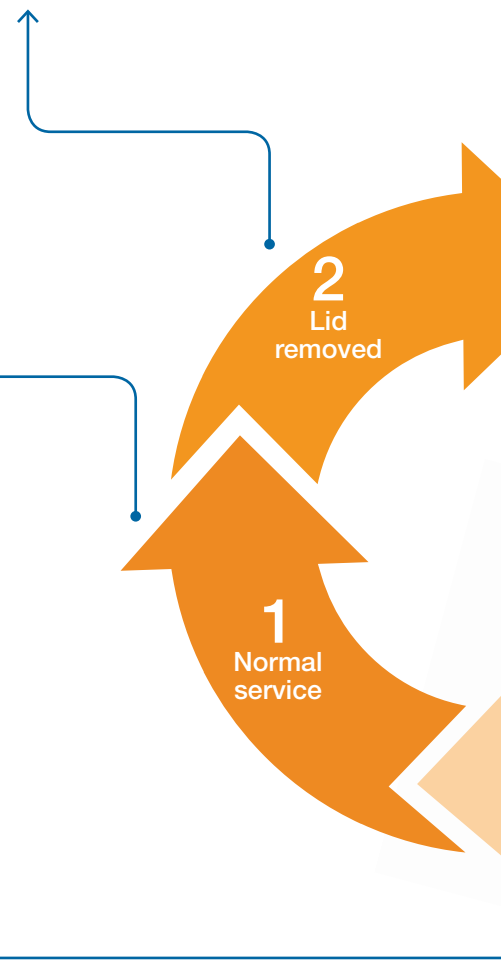

3. Preparation: Test plugs connections



3.1 The test equipment is equipped with **dia. 4 test plugs**.



3.2 The ESSAILEC® RJ45 test plug has **built-in dia. 4 (1) and RJ45 test sockets (2)** in order to simplify the test operations. They allow current and voltage **sensors measurement (1)** as well as **injection to the protection relay (2)**.

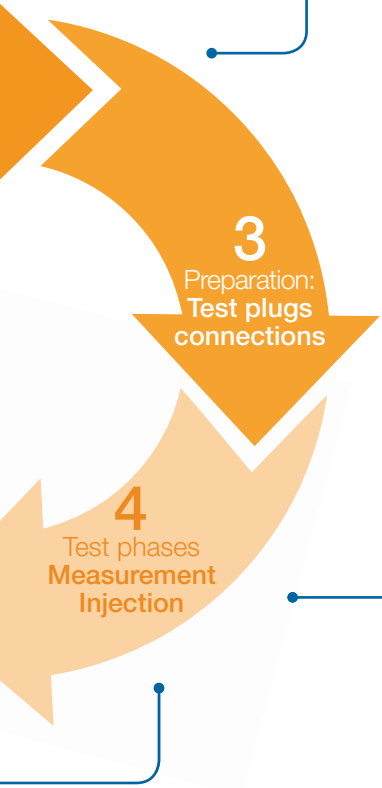

4. Test phase: Make before Break

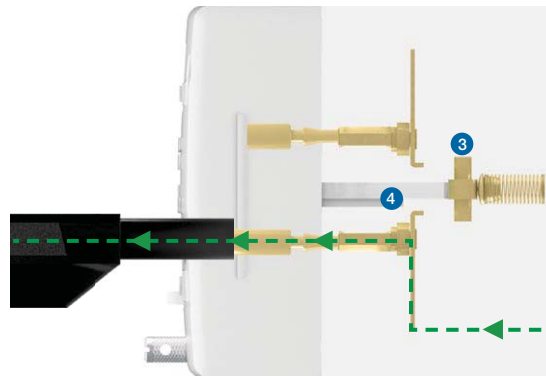

When the plug is fully inserted in the socket, inner mobile contacts (3) are pushed down by plug's plastic leads (4) and circuits are opened. Signals are derived into the **dia. 4** plug towards the test set.
It is possible to perform simultaneously current and voltage sensors measurement.

4.1 Test phase: Measurement



Ex: Voltage sensors measurement



Ex: Voltage and current sensors measurement

1SNC1691006950201

Current and voltage sensors application

ESSAILEC® RJ45 sockets for current and voltage sensors - Make before break



TC-E-RJ45

1SNC1691600014

Description

Dedicated for the use in Digital Switchgear including sensors (current or voltage):

- RJ45 connection type (Cat.5),
- Allow safe and easy measurement and injection operations,
- Signals protection against EMI/RFI thanks to shielded lid on shielded socket,
- Shielding tests according to IEC 62271-1 Annex J,
- Grounding point: M5 screw to be wired with an adapted ring lug termination.

Make before break principle:

- The circuits are automatically disconnected with the insertion of the plug,
- The circuits close automatically when the plug is removed.

Main technical data

Connecting capacity	IEC 947-1
Body	Polycarbonate UL94 V0
Conductive parts	Silver-plated
Rated voltage	125 V
Impulse withstand voltage	1000 V
Pollution degree	3
Rated current	1.5 A
Accuracy	0.5 %
Storage temperature range	-40 ... +85 °C
Working temperature range	-40 ... +85 °C
Protection without lid / with lid	IP20 / IP40

Mounting instructions

Tool (for grounding screw)		Posidriv Ø 4 mm Ø 0.16 in
Torque (for grounding screw)		1.2 Nm 10.8 lb.in

Ordering details

Color	Type	Part Number	Pkg qty	Weight 1 pce g
Socket				
Flush mounting				
Grey	<input type="checkbox"/> TC-E-RJ45-INF	1SNA566000R0000	3	138
Plug				
Grey	<input type="checkbox"/> FI-RJ45-DIA4	1SNA566001R0000	1	69.6

Compatible products

Lid / Cover	Plug	Socket
Included	FI-RJ45-DIA4	-
-	-	TC-E-RJ45-INF



Accessories

Description	Color	Type	Part Number	Pkg qty	Weight (1 pce) g
1 Protecting covers for RJ45 sockets	Grey	<input type="checkbox"/> CPT-RJ45	1SNA167002R0000	1	25.4



For connection details, please refer to mounting instruction 1SNC169044L1701

1SNC1691050201



Current transformers application

Make before break

Test principles	16
ESSAILEC® sockets for Current Transformers	22
ESSAILEC® pre-wired plugs for Current Transformers	24
ESSAILEC® universal adaptor with Ø 4mm outputs	25
ESSAILEC® customized plugs	26

Current transformers application

Make before break test principle

Measurement with 2x4 poles test plug

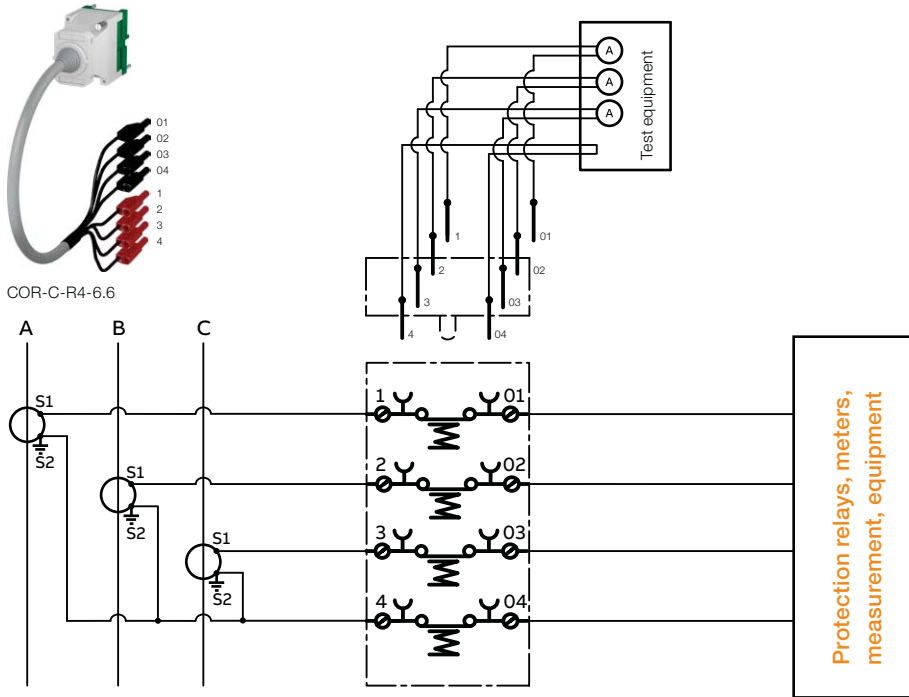

Injection or equipment replacement with 2x4 poles test plug

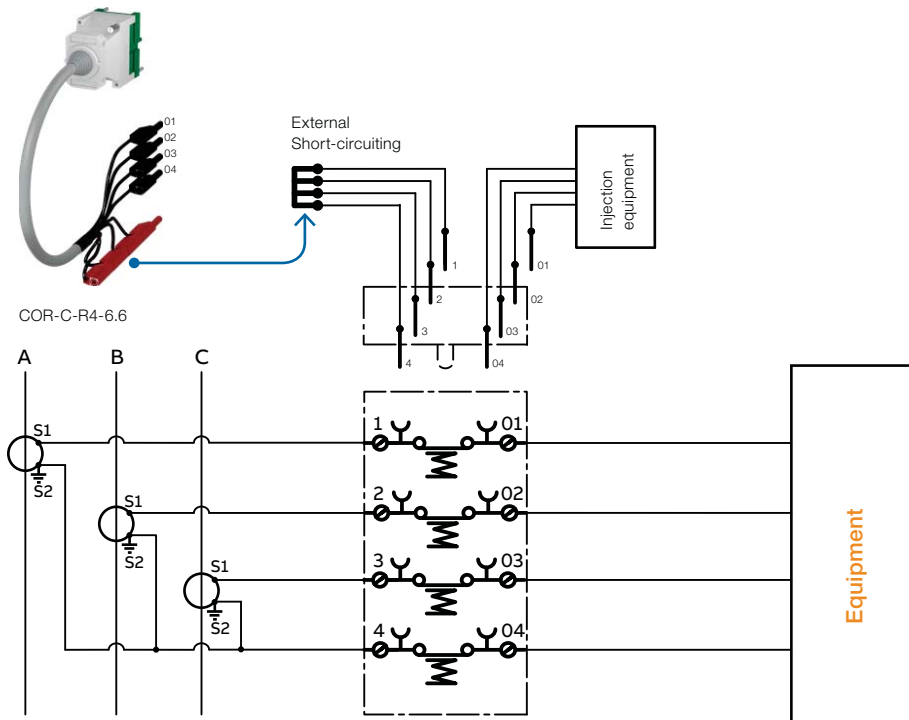

Make before break test principle

Injection or equipment replacement with 2x4 poles test plug (4 poles short-circuit)

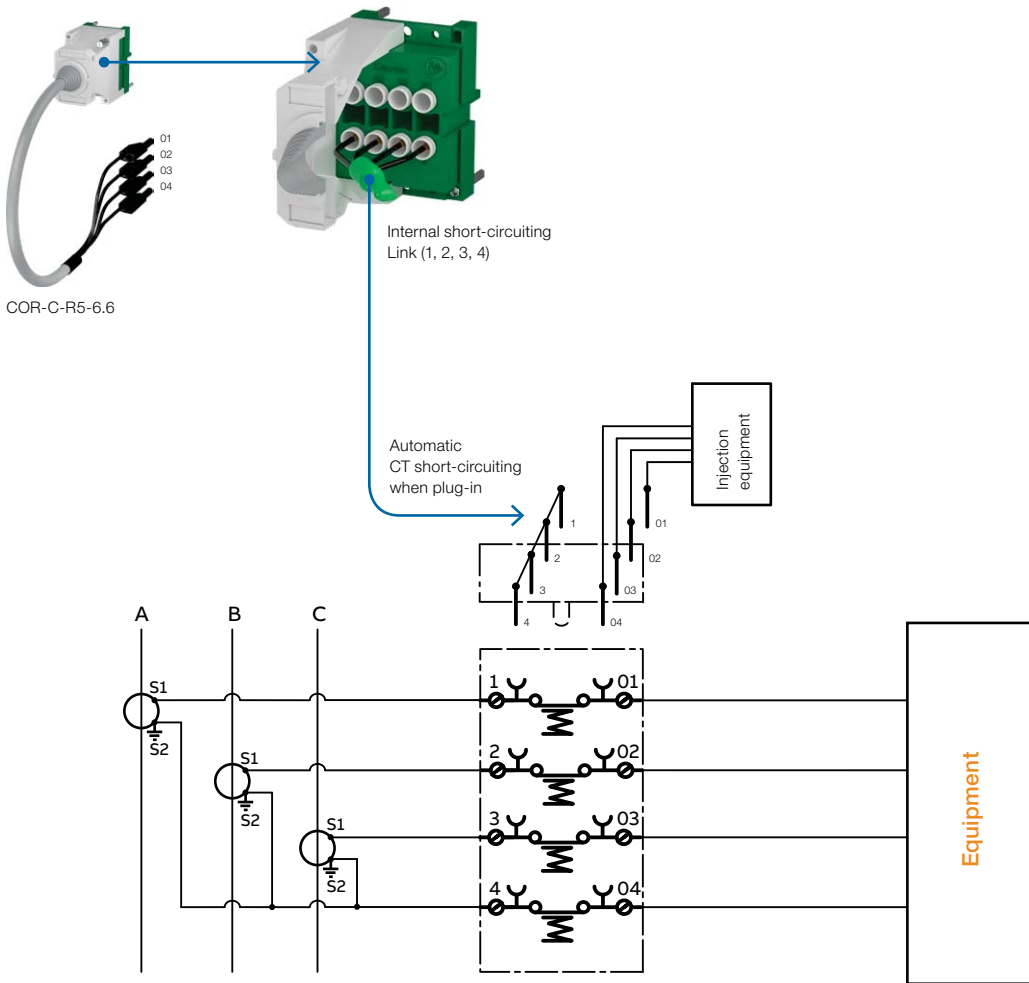

Current transformers application

Make before break test principle - With 2x4 poles test plug

Applications

- Measurement on CT's
- Injection
- Equipment replacement

1. Normal service



1.1 ESSAILEC® current sockets allow the simultaneous testing operations of 1 to 4 independent circuits on the same socket.

1.2 The lid is installed on the socket and can be sealed to prevent unauthorized access. **The socket circuits are closed** and signals flow from current transformers to the equipment to be tested.

2. Preparation: plug and lid



2.1 The lid is removed.

2.2 **Connect the ESSAILEC® test plug leads** to the test set. (For equipment change or injection, short-circuit externally the 4 test leads connected on the current transformer side: 1-2-3-4)

5. Back to normal service

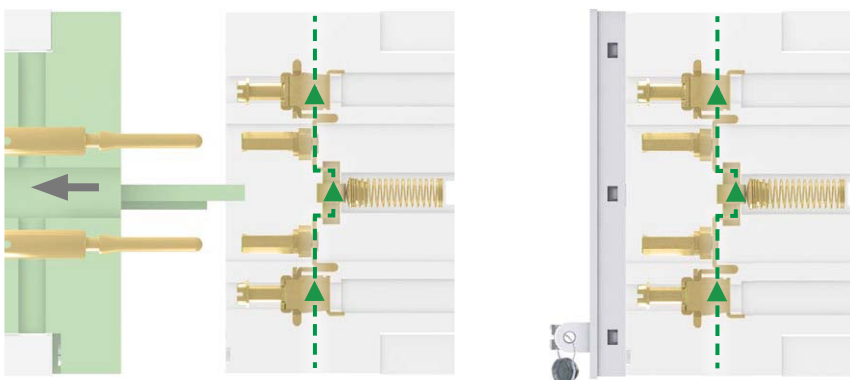

5.1 **Plug removal closes back the socket contacts** and signals flow again through the socket.

5.2 Lid is put back in place.

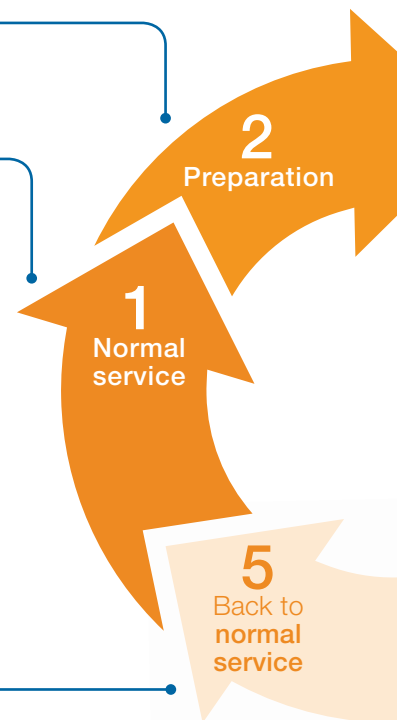

3. Test phase: Make

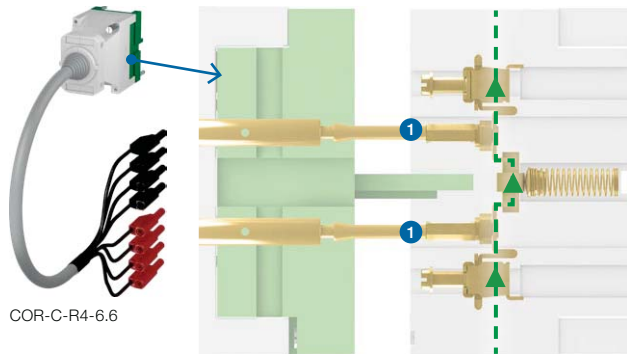

During plug insertion, plug pins make contact with socket pins (1). **Contacts remain closed and the signal flow has not change.** This operation prevent signal interruption (mandatory for current transformers).

4.1 Measurement: Test phase - Break

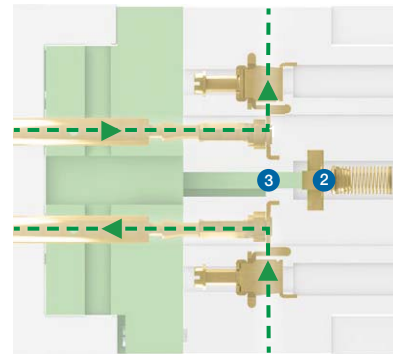

When the plug is fully inserted in the socket, inner mobile contacts (2) are pushed down by plug's plastic leads (3) and **the four circuits are opened simultaneously.** Signals are derived into the plug towards the test set without interruption of continuity.

4.2 Injection or equipment replacement: Test phase - Break

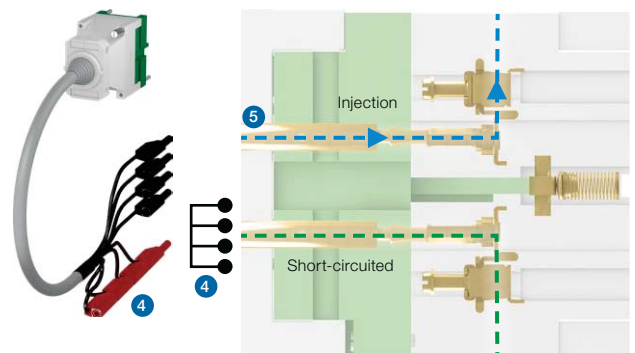

During preparation phase, the plug 4 test leads (1-2-3-4: current transformer side) **have been short-circuited externally (4).**

When the plug is fully inserted in the socket, **the current transformer is automatically short-circuited** and current injection (or equipment change) can be done on the equipment side (5).



Current transformers application

Make before break test principle - With 2x4 poles test plug (4 poles short-circuited)

Applications

- Measurement on CT's
- Injection
- Equipment replacement

1. Normal service



1.1 ESSAILEC® current sockets allow the simultaneous testing operations of 1 to 4 independent circuits on the same socket.

1.2 The lid is installed on equipment side (1-2-3-4). The lid is removed. The socket and can be sealed to prevent unauthorized access. The socket circuits are closed and signals flow from current transformers to the equipment to be tested.

2. Preparation: plug and lid



2.1 The lid is removed.

2.2 Connect the ESSAILEC® test plug leads to the test set. This plug is equipped with a built-in short-circuiting on equipment side (1-2-3-4).

5. Back to normal service

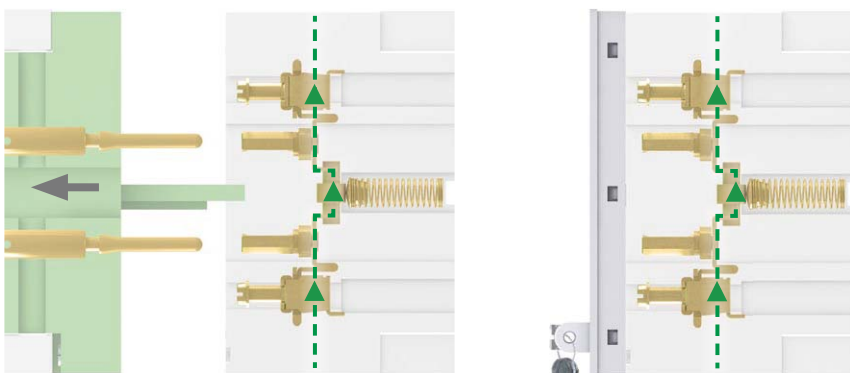

5.1 Plug removal closes back the socket contacts and signals flow again through the socket.

5.2 Lid is put back in place.



3. Test phase: Make & CT short-circuiting

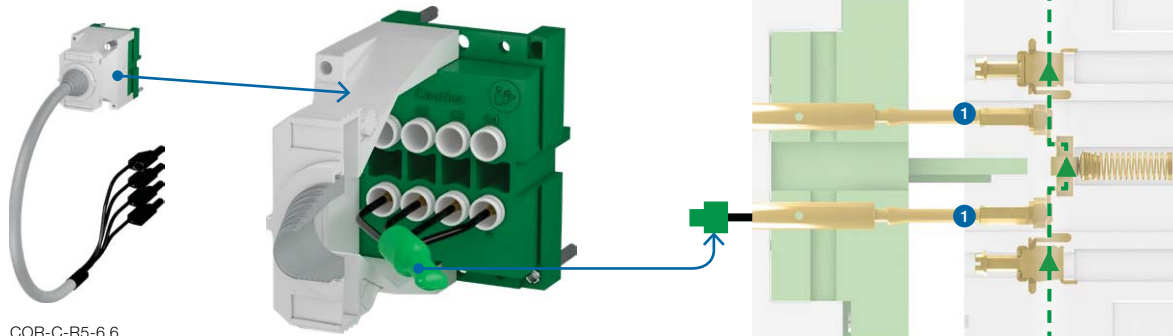

COR-C-R5-6.6

The plug is equipped with built in short circuited contacts on current transformers side (1-2-3-4)

During plug insertion, plug pins make contact with the socket pins (1), **and simultaneously the current transformer is short-circuited.**

3

Test phase:
Make

4. Test phase: Break and short-circuit (injection or equipment replacement)

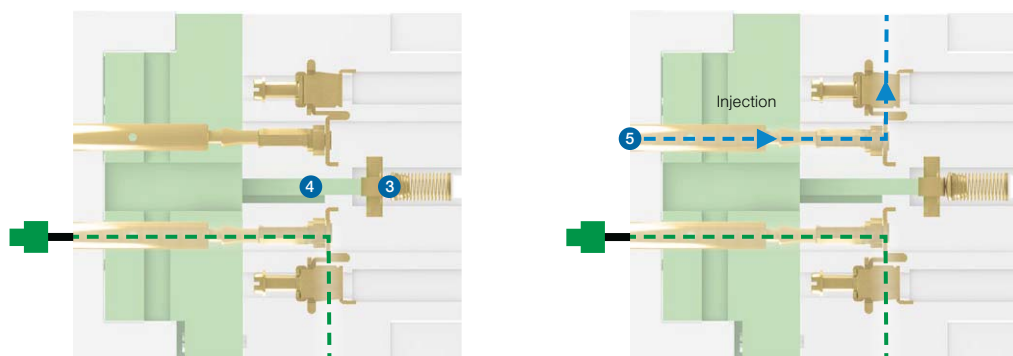

4.1 When the plug is fully inserted in the socket, inner **mobile contacts (3) are opened by plastic lead (4)**. The current transformer is automatically short-circuited and circuits are opened.

4.2 Current injection can be done on the equipment (5).

Current Transformers application

ESSAILEC® sockets for Current Transformers – Make before break



CC-E-VA

Description

Short-circuited type contacts for measurement, calibration and distribution applications.

Make before break principle:

- The circuit is automatically shorted with the insertion of the plug.
- The circuit closes automatically when the plug is removed.
- This system guarantees a complete safety.
- By convention, green coding is for current circuit.

Main technical data

Connecting capacity		IEC 947-1
Screw clamp (VL)	Rigid: Solid/Stranded Flexible with insulated ferrule	0.2 ... 6 mm ² 0.22 ... 4 mm ²
Ring tongue (VA)	Flexible with insulated ferrule Ø lug hole size Width	0.34 ... 10 mm ² 3 mm 7.5 mm
Body	Polycarbonate	
Conductive parts	Gold-plated	
Rated voltage	400 V	
Impulse withstand voltage	4000 V	
Pollution degree	3	
Rated current	15 A	
Short-circuit current	100 A/5 s ... 200 A/1 s	
Storage temperature range	-25 ... +70 °C	
Working temperature range	-10 ... +55 °C	
Protection without lid / with lid	IP20 / IP40	
Coding color	Green ■	

Mounting instructions

Rail		G32, TH 35-7.5, TH 35-15
Screw clamp		
Wire stripping length		9.5 mm 0.370 in
Tool		Flat screwdriver Ø 4 mm Ø 0.157 in
Torque		0.5 ... 0.8 Nm 4.4 ... 7.1 lb.in

Ordering details

Type	Part Number	Pkg qty	Weight
			1 pce g

Flush mounting

Ring-tongue			
CC-E-VA	1SNA166737R2000	1	145
CC-E-VA-6.6	1SNA166625R2000	1	150
CC-E-VA-R2-6.6	1SNA166976R0000	50	170

Base / Half-base mounting

Screw clamp			
CC-S-INF-VL-6.6	1SNA166722R2100	1	200
Ring-tongue			
CC-D-VA	1SNA166738R0100	1	90

TH35 rail mounting

Screw clamp			
CC-TH35-VL-6.6	1SNA166963R0000	1	114

Rack mounting

Ring-tongue			
CC-R-VA	1SNA166523R1200	1	140

Reverse mounting

Ring-tongue			
CC-I-VA-2	1SNA166941R2500	1	210

Compatible products

Lid	Cover	Universal plug Ø 4 mm	Pre-wired plugs		
			2x4 poles Ø 4 mm bayonet	4 poles Ø 4 mm bayonet	1 pole Ø 4 mm bayonet
CPC-1	-	FIC-2/4-DIA4	COR-C-R4-6.6	COR-C-R5-6.6	COR-C-R3
Lid + coding included			COR-C-R1-6.6	COR-C-R2-6.6	COR-C-3
-	Cover + coding included	FIC-2/4-DIA4	COR-C-R4-6.6	COR-C-R5-6.6	COR-C-R3
			COR-C-R1-6.6	COR-C-R2-6.6	COR-C-3
CPC-1	-	FIC-2/4-DIA4	COR-C-R4-6.6	COR-C-R5-6.6	COR-C-R3
			COR-C-R1-6.6	COR-C-R2-6.6	COR-C-3
CPC-1	included	FIC-2/4-DIA4	COR-C-R4-6.6	COR-C-R5-6.6	COR-C-R3
			COR-C-R1-6.6	COR-C-R2-6.6	COR-C-3
CPC-1	-	FIC-2/4-DIA4	-	-	COR-C-R3
			-	-	COR-C-3
-	-	-	-	-	COR-C-R3
			-	-	COR-C-3

* compatible with CC-DS-VL socket only in "base" mounting option.

Current Transformers application

ESSAILEC® sockets for Current Transformers – Make before break

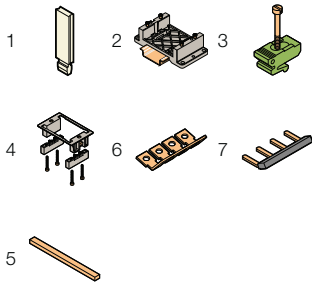

Accessories

Description	Type	Part Number	Pkg qty	Weight 1 pce
1 Interlocking peg For 2 sockets assembly	CVABM	1SNA183436R0500	10	0.4 g
2 Mounting kits For TH35 rail (a)	KEM-3	1SNA166962R0000	10	24
3 For DIN 1 rail (a)	FX	1SNA167682R2300	10	20
4 For ring-tongue flush mounting (b)	KEM-1	1SNA166928R2000	50	18
6 Lateral jumper bars Compatible with ring-tongue connection only (VA) (b)	PCVA	1SNA167496R1100	10	1
7 Compatible with screw connection only (VL); IP20 (c)	PCVL	1SNA167681R2200	10	1
5 Jumper bars For two sockets screw connection type (c)	BJ-VL	1SNA167680R0500	10	1

(a) compatible with base mounting only.
 (b) compatible with ring-tongue connection type socket only (VA).
 (c) compatible with screw connection type socket only (VL).

Compatible products

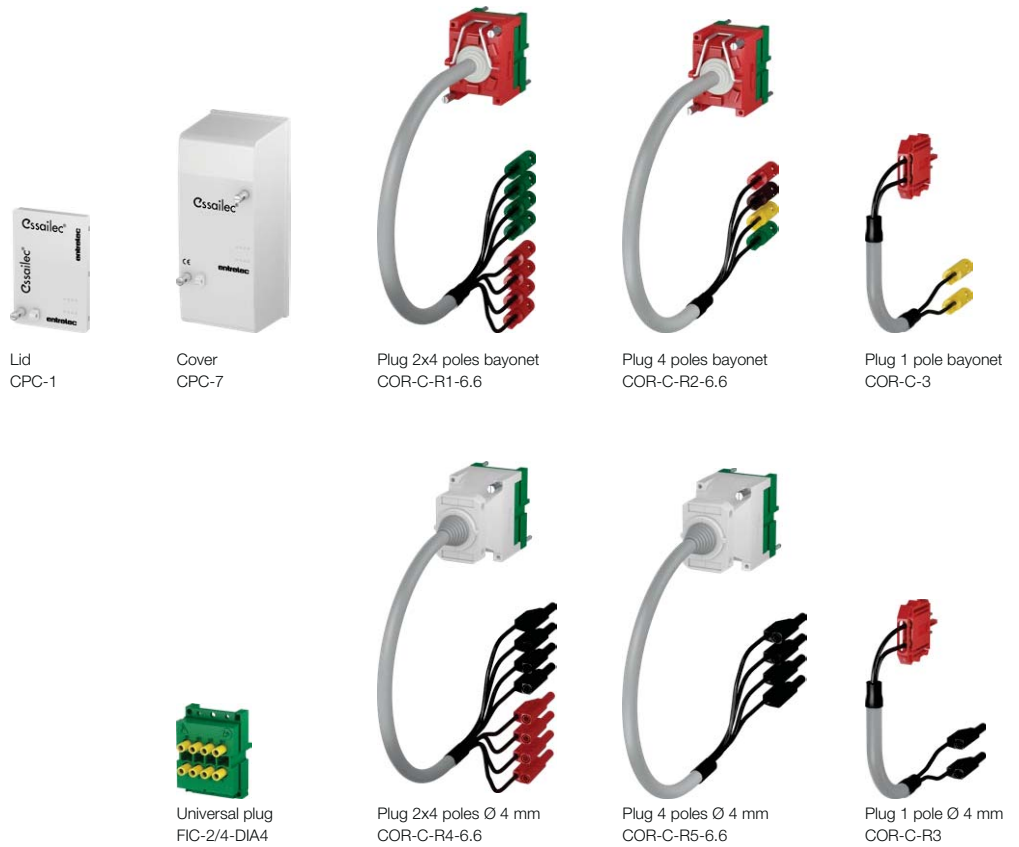

Connection technologies



3

1SNC1691016S0201

Current Transformers application

ESSAILEC® pre-wired plugs for Current Transformers

Description

- Standard current plugs are compatible with ESSAILEC® current sockets.
- Plugs are pre-wired with contact pins (BRE...), coding, cables and test plugs assembled to ease your test operations.

Main technical data

Connecting capacity	IEC 947-1
Body	Polycarbonate
Conductive parts	Gold-plated
Rated voltage	400 V
Impulse withstand voltage	4000 V
Pollution degree	3
Rated current	15 A
Short-circuit current	100 A/5 s ... 200 A/1 s
Storage temperature range	-25 ... +70 °C
Working temperature range	-10 ... +55 °C

Ordering details

Description	Type	Part Number	Pkg qty	Weight 1 pce g	Compatible products Socket
Plug 2x4 poles					
<p>1 plug 2x4 pins / Green 4 x Ø 4 mm test plugs / Black 4 x Ø 4 mm test plugs / Red Conductors section: 2.5 mm² cable length: 2 m / 79"</p>	COR-C-R4-6.6	1SNA167932R1500	1	1080	CC-E-VA CC-E-VA-6.6 CC-E-VA-R2-6.6 CC-S-INF-VL-6.6 CC-D-VA CC-TH35-VL-6.6
<p>1 plug 2x4 pins / Green 4 bayonet security test plugs / Green 4 bayonet security test plugs / Red Conductors section: 2.5 mm² cable length: 2 m / 79"</p>	COR-C-R1-6.6	1SNA166638R0500	1	1080	CC-E-VA CC-E-VA-6.6 CC-E-VA-R2-6.6 CC-S-INF-VL-6.6 CC-D-VA CC-TH35-VL-6.6
Plug 4 poles					
<p>1 plug 2x4 pins with 4 short circuited pins (1-2-3-4) / Green 4 x Ø 4 mm test plugs / Black Conductors section: 2.5 mm² cable length: 2 m / 79"</p>	COR-C-R5-6.6	1SNA167934R1700	1	670	CC-E-VA CC-E-VA-6.6 CC-E-VA-R2-6.6 CC-S-INF-VL-6.6 CC-D-VA CC-TH35-VL-6.6
<p>1 plug 2x4 pins with 4 short circuited pins (1-2-3-4) / Green 1 bayonet security test plug / Green 1 bayonet security test plug / Grey 1 bayonet security test plug / Brown 1 bayonet security test plug / Yellow Conductors section: 2.5 mm² cable length: 2 m / 79"</p>	COR-C-R2-6.6	1SNA166778R1100	1	670	CC-E-VA CC-E-VA-6.6 CC-E-VA-R2-6.6 CC-S-INF-VL-6.6 CC-D-VA CC-TH35-VL-6.6
Plug 1 pole					
<p>1 plug 2 pins / Red 2 dia. 4 mm test plugs / Black</p>	COR-C-R3	1SNA166979R0000	1	320	CC-E-VA CC-E-VA-6.6 CC-E-VA-R2-6.6 CC-S-INF-VL-6.6 CC-D-VA CC-TH35-VL-6.6 CC-R-VA CC-I-VA-2
<p>1 plug 2 pins / Red 2 bayonet security test plugs / Yellow</p>	COR-C-3	1SNA166643R0200	1	320	CC-E-VA CC-E-VA-6.6 CC-E-VA-R2-6.6 CC-S-INF-VL-6.6 CC-D-VA CC-TH35-VL-6.6 CC-R-VA CC-I-VA-2

1SNC1691075/0201

Current Transformers application

ESSAILEC® universal adaptor with Ø 4mm outputs



FIC-2/4-DIA4

Description

- Universal adaptor compatible with all ESSAILEC® current socket
- It ensures quick and consistently reliable ESSAILEC® sockets tests
- Ø 4 mm test plugs may be inserted directly without the need for extra accessories or tools. It is compatible with all the insulated Ø 4mm test plugs available on the market

Standard current plugs are compatible with ESSAILEC® current sockets.

- Plugs are pre-wired with contact pins (BRE...), coding, cables and test plugs assembled to ease your test operations.

Main technical data

Connecting capacity	IEC 947-1
Body	Polycarbonate
Conductive parts	Gold-plated
Rated voltage	400 V
Impulse withstand voltage	4000 V
Pollution degree	3
Rated current	15 A
Short-circuit current	100 A/5 s ... 200 A/1 s
Storage temperature range	-25 ... +70 °C
Working temperature range	-10 ... +55 °C

Ordering details

Description	Type	Part Number	Pkg qty	Weight 1 pce g
Universal plug Plug 2x4 pins with direct insertion Ø 4 mm	FIC-2/4-DIA4	1SNA167937R0000	1	60

Compatible products

Socket
CC-E-VA
CC-E-VA-6.6
CC-E-VA-R2-6.6
CC-S-INF-VL-6.6
CC-D-VA
CC-TH35-VL-6.6
CC-R-VA

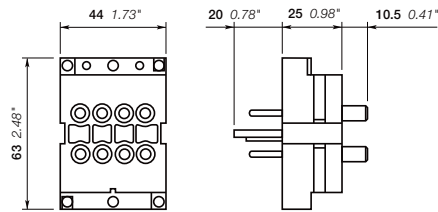

Dimensions (mm, inches)

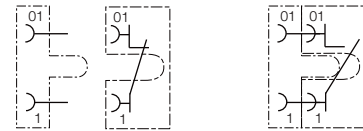

Adaptor Socket Adaptor + socket

Electrical wiring for a socket with short-circuited contacts and an universal adaptor

For connection details, please refer to mounting instruction 1SNC169041L0201

Current Transformers application

ESSAILEC® customized plugs





Description

Short-circuited type contacts for measurement, calibration and distribution applications.

Make before break principle:

- The circuit is automatically shorted with the insertion of the plug.
- The circuit closes automatically when the plug is removed.
- This system guarantees a complete safety.
- By convention, green coding is for current circuit.

Ordering details

Description	Type	Part Number	Pkg qty	Weight 1 pce g	Compatible products Socket
1 pole plug with contact pins					
 Plug with 2x 2.5 mm ² contact pins (BRE-C-2.5), without coding pins.	FIC-2/1-1	1SNA166819R2300	1	27	CC-E-VA CC-E-VA-6.6 CC-E-VA-R2-6.6 CC-S-INF-VL-6.6 CC-D-VA CC-TH35-VL-6.6 CC-R-VA CC-I-VA-2
Plugs without contact pins (contact pins BRE-C..., to be ordered separately)					
 Plugs 2x4 poles, long cover, with 2 coding pins (COP-FI-1) and 8 locking pins. Contacts pins (BRE-C...) to be ordered separately.	FIC-2/4-2	1SNA166936R1000	1	105	CC-E-VA CC-E-VA-6.6 CC-E-VA-R2-6.6 CC-S-INF-VL-6.6 CC-D-VA CC-TH35-VL-6.6
 Plugs 2x4 poles, short cover, with 2 coding pins (COP-FI-1) and 8 locking pins. Contacts pins (BRE-C...) to be ordered separately.	FIC-2/4-1	1SNA166525R1400	1	91	CC-E-VA CC-E-VA-6.6 CC-E-VA-R2-6.6 CC-S-INF-VL-6.6 CC-D-VA CC-TH35-VL-6.6
 Plug 2x4 poles, rack mounting R version, with 2 coding pins (COP-FI-1) and 8 locking pins. Contacts pins (BRE-C...) to be ordered separately.	FIC-2/4-R	1SNA166529R2000	1	80	CC-R-VA
 Plug 2x4 poles, reverse mounting I version, with 2 coding pins (COP-FI-1) and 8 locking pins. Contacts pins (BRE-C...) to be ordered separately.	FIC-2/4-I	1SNA166589R2500	1	60	CC-I-VA-2
BRE contact pins					
Pin 1 mm ²	BRE-C-1	1SNA167264R0700	10	2.6	-
Pin 1.5 mm ²	BRE-C-1.5	1SNA167265R0000	10	2.6	-
Pin 2.5 mm ²	BRE-C-2.5	1SNA167260R1700	10	3	-
Pin 4 mm ²	BRE-C-4	1SNA205876R0400	10	3	-
Pin 6 mm ²	BRE-C-6	1SNA168146R0200	10	3	-
Tools for contact pins					
1 Pin extraction tool	EXBR1	1SNA167008R0300	1	24	-
2 Crimping tool for BRE pins 1 to 2.5 mm ² (1)	PSC	1SNA173181R1300	1	478	-
3 Locking sleeve for contact pin	DLVR	1SNA167971R2400	10	0.4	-
dia 4 mm test plugs					
4 IP20 with mobile protection	FC4-1	1SNA167927R1000	10	11	-
5 IP20 with permanent protection	FC4-5	1SNA167931R1400	10	10	-
Bayonet plugs					
6 Bayonet security test plug / Black	FCB-1	1SNA167690R0700	10	7	-
Bayonet security test plug / Red	FCB-2	1SNA167692R2500	10	7	-
7 Isolating cap for FCB plug	CA	1SNA167697R2200	10	1.2	-
Accessories					
8 Straight adaptor	IR1	1SNA167622R2600	5	15	-
9 H adaptor (short-circuit bridge)	IR2	1SNA167623R2700	5	35	-
10 Isolating cap for IR1 and IR2 adaptors	DI	1SNA167981R1700	10	7	-
11 Adaptor between FCB plug and ring-tongue test interface	IR3	1SNA167624R2000	10	6.4	-
Coding pins					
12 Plug coding pin	COP-FI-1	1SNA167378R1100	10	2.3	-

(1) Referring to 1SNC169040D1702 to find other crimping tools

1SNC169019S0201

Current Transformers application

ESSAILEC® customized plugs

Pin installation on plugs

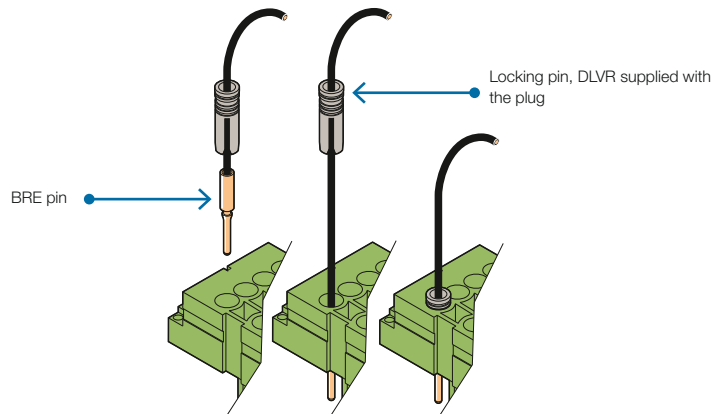



Make before break	30
Break before make	36
Closed contact	42
Independent circuits	48
Pre-wired plugs	49
Customized plugs	51

Voltage transformers application

Make before break test principle

Simultaneous measurement and injection with 2x4 poles test plug

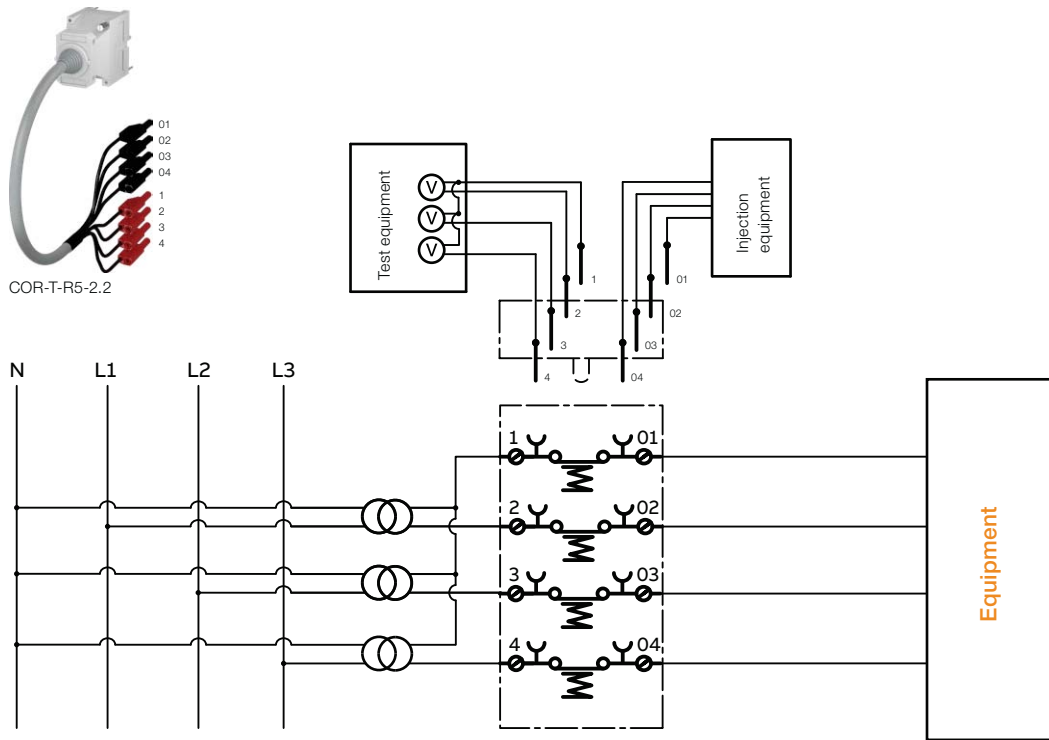

Measurement with 2x4 poles test plug

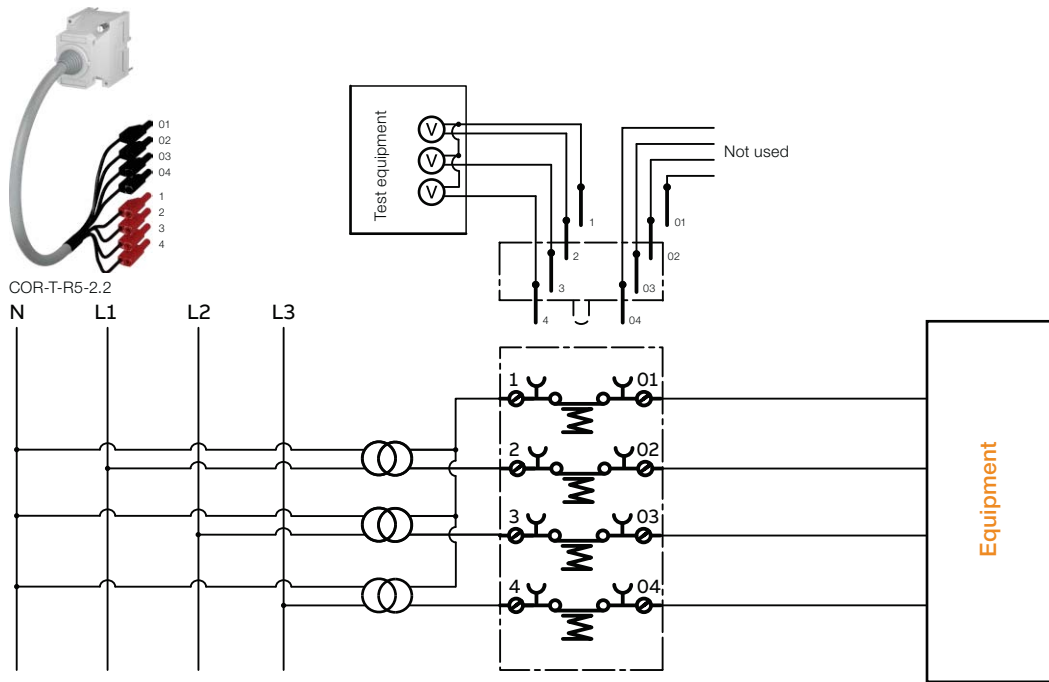

Make before break test principle

Injection with 2x4 poles test plug

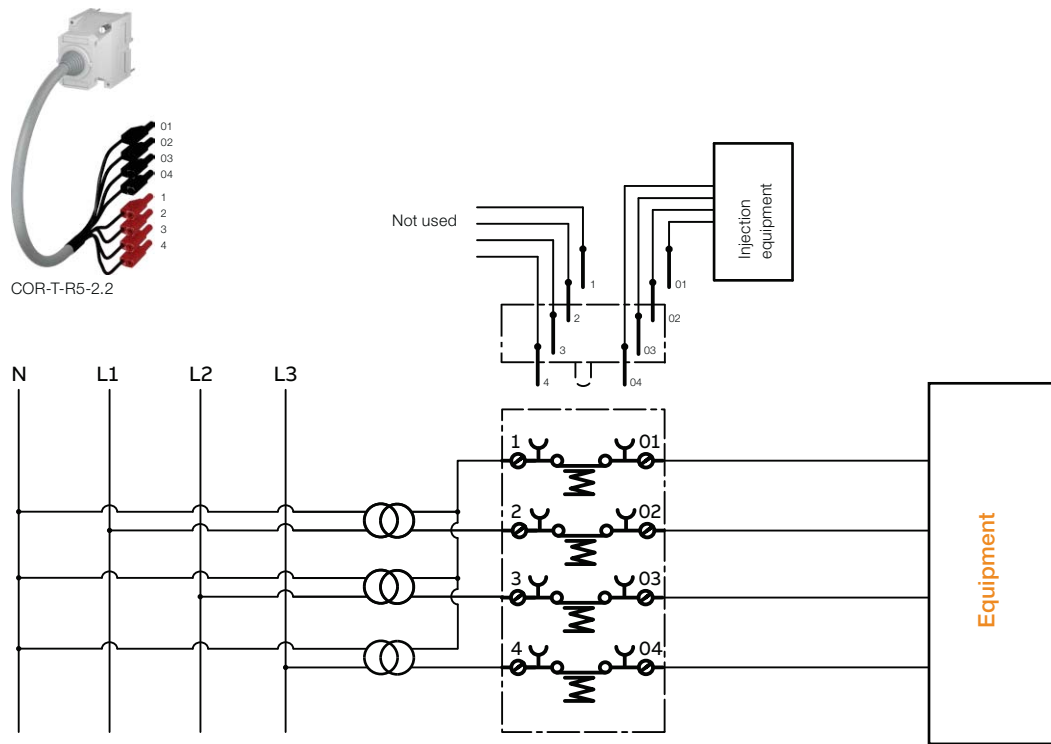

Voltage transformers application

Make before break test principle - With 2x4 poles test plug

Applications

- Measurement on VT's
- Injection
- Equipment replacement

1. Normal service



1.1 ESSAILEC® voltage sockets allow the simultaneous testing operations of 1 to 4 independent circuits on the same socket.

1.2 The lid is installed on the socket and can be sealed to prevent unauthorized access. **The socket circuits are closed** and signals flow from current transformers to the equipment to be tested.

2. Preparation: plug and lid



2.1 The lid is removed.

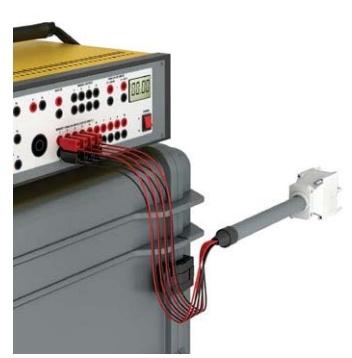

2.2 Connect the ESSAILEC® test plug leads to the test set.

5. Back to normal service

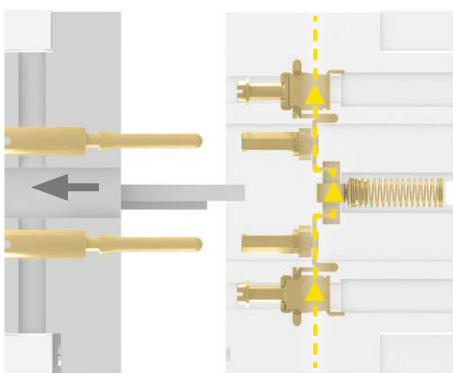

5.1 Plug removal closes back the socket contacts and signals flow again through the socket.

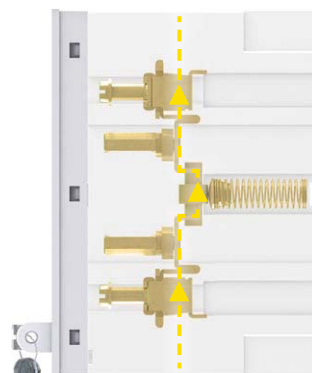

5.2 Lid is put back in place.

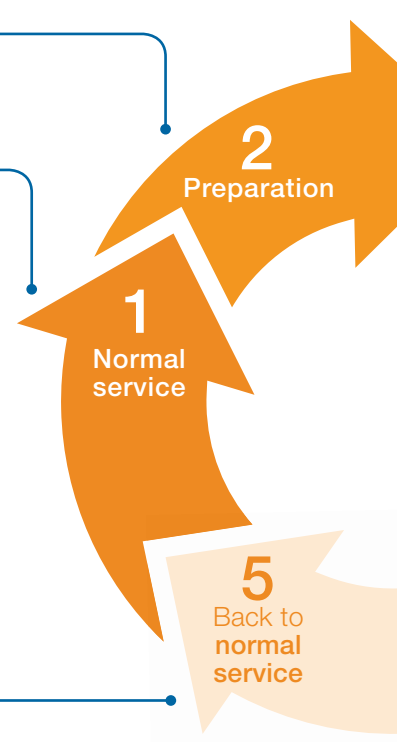

3. Test phase: Make

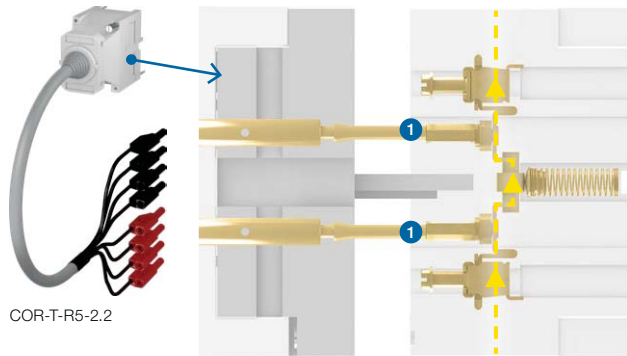

During plug insertion, plug pins make contact with socket pins (1). **Contacts remain closed and the signals flow has not changed.**

4.1 Measurement: test phase - Break

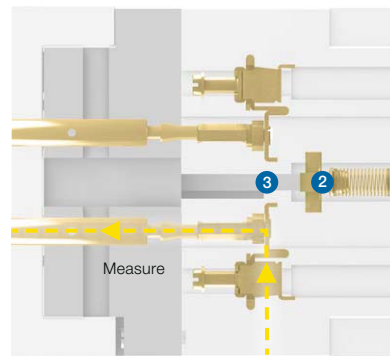

When the plug is fully inserted in the socket, inner mobile contacts (2) are pushed down by plug's plastic leads (3) and **the four circuits are opened simultaneously**. Signals are derived into the plug towards the test set. The equipment to be tested is no more energized.

4.2 Injection or equipment replacement: test phase - Break

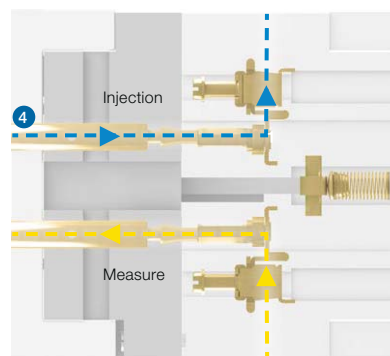

In a second step or simultaneously, **voltage injection** can be done on the protection relay side (4).



Voltage transformers application

ESSAILEC® sockets for voltage transformers - Make before break



TC-E-VA

Description

Short-circuited contacts for measurement, calibration and distribution applications.

Make before break principle:

- The circuit is automatically shorted with the insertion of the plug.
- The circuit closes automatically when the plug is removed.
- This system guarantees a complete safety.
- By convention grey coding is for voltage circuits and blue coding is for polarity circuits.

Main technical data

Connecting capacity		IEC 947-1
Screw clamp (VL)	Rigid: Solid/Stranded	0.2 ... 6 mm ²
	Flexible with insulated ferrule	0.22 ... 4 mm ²
Ring tongue (VA)	Flexible with insulated ferrule	0.34 ... 10 mm ²
	Ø lug hole size	3 mm
	Width	7.5 mm
Quick-connect	Flexible with insulated ferrule	2.5
Body		Polycarbonate
Conductive parts		Silver-plated
Rated voltage		400 V
Impulse withstand voltage		4000 V
Pollution degree		3
Rated current		8 A
Short-circuit current		25 A/5 s ... 800 A/25 ms
Storage temperature range		-25 ... +70 °C
Working temperature range		-10 ... +55 °C
Protection without lid / with lid		IP20 / IP40
Coding color		Grey <input type="checkbox"/> - Blue <input type="checkbox"/>

Mounting instructions

Rail		G32, TH 35-7.5, TH 35-15
Screw clamp		
Wire stripping length		9.5 mm 0.370 in
Tool		Flat screwdriver Ø 4 mm Ø 0.157 in
Torque		0.5 ... 0.8 Nm 4.4 ... 7.1 lb.in

Ordering details

Color	Type	Part Number	Pkg qty	Weight 1 pce g
Grey <input type="checkbox"/>	TC-E-VA	1SNA166747R0200	1	140
	TC-E-VA-2-2	1SNA166627R2200	1	150
	TC-E-VA-R2-2.2	1SNA166977R0000	50	150
Blue <input type="checkbox"/>	PC-E-VA	1SNA166763R0200	1	145
	PC-E-VA-8.8	1SNA166630R0100	1	200

Quickconnect

Grey <input type="checkbox"/>	TC-E-C5A-2.2	1SNA166628R0300	1	170
-------------------------------	--------------	-----------------	---	-----

Base / Half-base mounting

Screw clamp

Grey <input type="checkbox"/>	TC-DS-VL	1SNA166742R0500	1	100
	TC-S-INF-VL-2.2	1SNA166948R0400	1	170
Blue <input type="checkbox"/>	PC-DS-VL	1SNA166758R1500	1	130

Ring-tongue

Grey <input type="checkbox"/>	TC-D-VA	1SNA166748R1300	1	147
Blue <input type="checkbox"/>	PC-D-VA	1SNA166764R0300	1	115

TH35 rail mounting

Screw clamp

Grey <input type="checkbox"/>	TC-TH35-VL	1SNA166964R0000	1	114
-------------------------------	------------	-----------------	---	-----

Compatible products

Lid	Cover	Universal plug	Pre-wired plugs	
			2x4 poles	4 poles
CPT-1	-	FI-2/4-DIA4	COR-T-R5-2.2	COR-T-4-4
Lid + coding included				
CPP-1			COR-P-R1-8.8	-
Lid + coding included				
Lid + coding included	-	FI-2/4-DIA4	COR-T-R5-2.2	COR-T-4-4
CPT-1	CPT-5 (1)	FI-2/4-DIA4	COR-T-R5-2.2	COR-T-4-4 (2)
-	Cover + coding included			COR-T-4-4
CPT-1	-		COR-P-R1-8.8	-
CPP-1	-	FI-2/4-DIA4	COR-T-R5-2.2	COR-T-4-4 (2)
			COR-P-R1-8.8	-
CPT-1	CPT-5	FI-2/4-DIA4	COR-T-R5-2.2	COR-T-4-4

(1) Compatible only in base mounting option.

(2) Compatible with some restrictions, please contact us.

Information on pre-wired plugs: Please refer to page "ESSAILEC® pre-wired plugs for voltage transformers".

Voltage transformers application

ESSAILEC® sockets for voltage transformers - Make before break

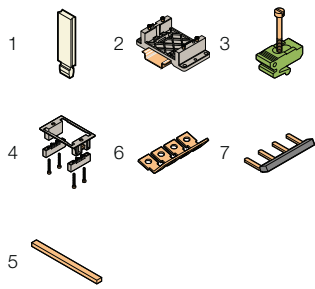

Accessories

Description	Type	Part Number	Pkg qty	Weight 1 pce g
1 Interlocking peg For 2 sockets assembly	CVABM	1SNA183436R0500	10	0.4
2 Mounting kits For TH35 rail (a)	KEM-3	1SNA166962R0000	10	24
3 For DIN 1 rail (a)	FX	1SNA167682R2300	10	20
4 For ring-tongue flush mounting (b)	KEM-1	1SNA166928R2000	50	18
6 Lateral jumper bars Compatible with ring-tongue connection only (VA) (b)	PCVA	1SNA167496R1100	10	1
7 Jumper bars Compatible with screw connection only (VL); IP20 (c)	PCVL	1SNA167681R2200	10	1
5 Jumper bars For two sockets screw connection type (c)	BJ-VL	1SNA167680R0500	10	1

(a) compatible with base mounting only.

(b) compatible with ring-tongue connection type socket only (VA).

(c) compatible with screw connection type socket only (VL).

Compatible products



Lid
CPC-1

Cover
CPC-7



Universal plug
FI-2/4-DIA4

Plug 2x4 poles
COR-T-R5-2.2

Plug 4 poles
COR-T-4-4
Design for insertion 01-02-03-04

Connection technologies



Ring-tongue

Screw clamp

Quick-connect

1SNC169102/05/0201

Voltage transformers application

Break before make test principle

Simultaneous measurement and injection with 2x4 poles test plug

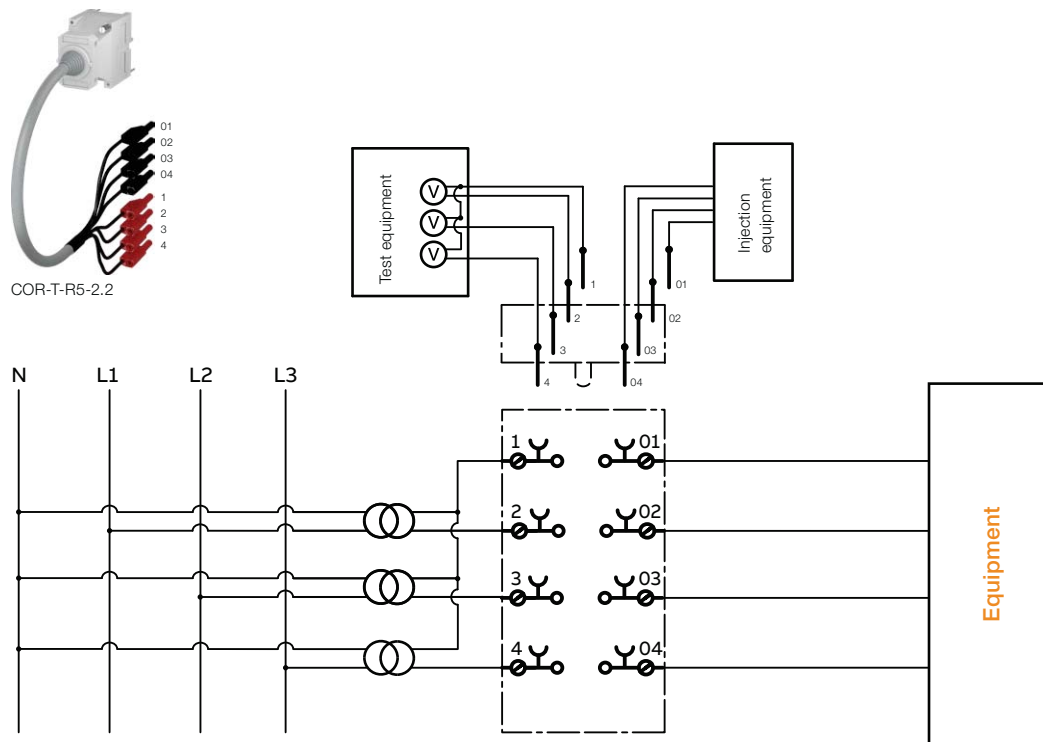

Break before make test principle

Measurement or/and injection with 4 poles test plugs

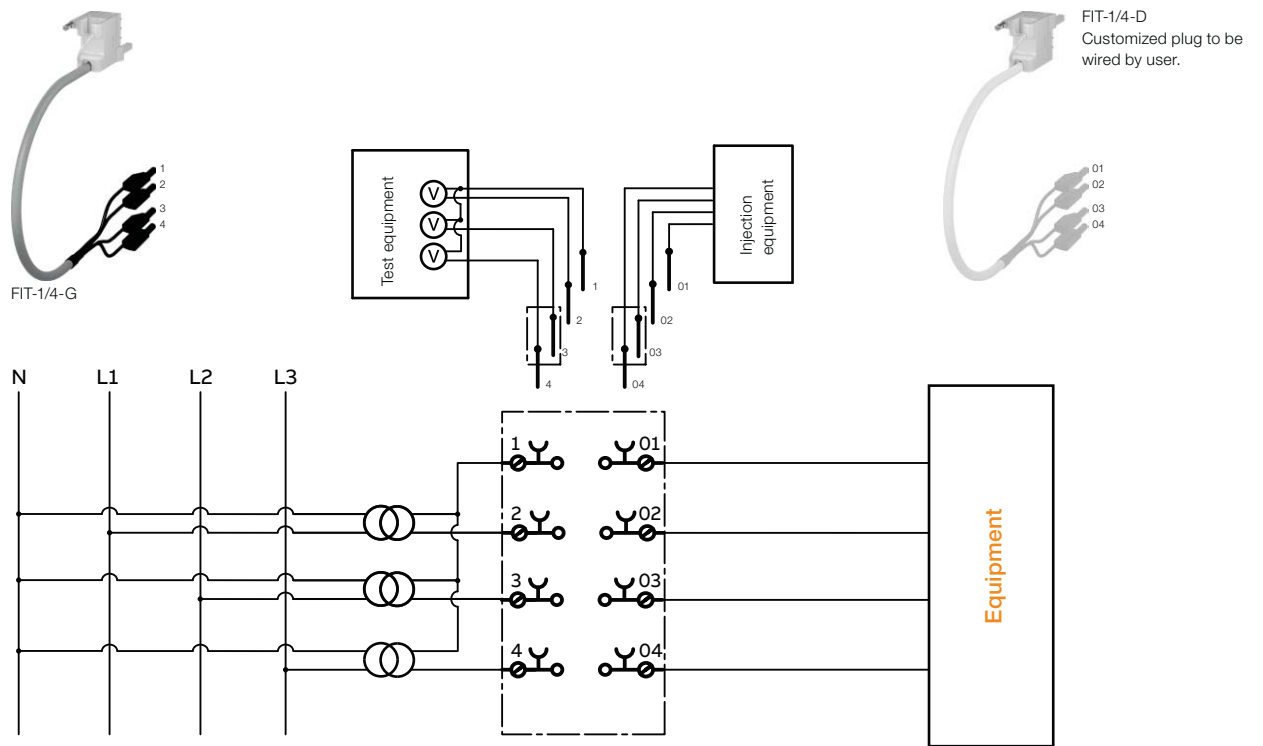

Voltage transformers application

Break before make test principle - With 2x4 or 4 poles test plug

Applications

- Measurement on VT's
- Injection
- Equipment replacement

1. Normal service



1.1 ESSAILEC® voltage sockets allow the simultaneous testing operations of 1 to 4 independent circuits on the same socket.

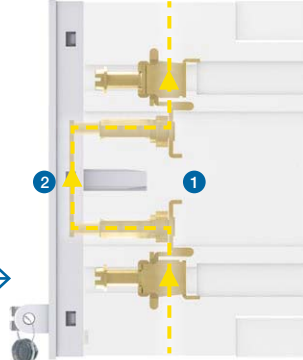

1.2 The lid is installed on the socket and can be sealed to prevent unauthorized access. **The socket has no mobile contacts (closed style) (1).** Circuit continuity is ensured by the lid equipped with built-in contact pins (2).

2. Preparation: plug



Connect the ESSAILEC® test plug leads to the test set.

5. Back to normal service



5.1 When the plug is removed, signals are disconnected.



5.2 When lid is put back in place, signals flow again through the socket.

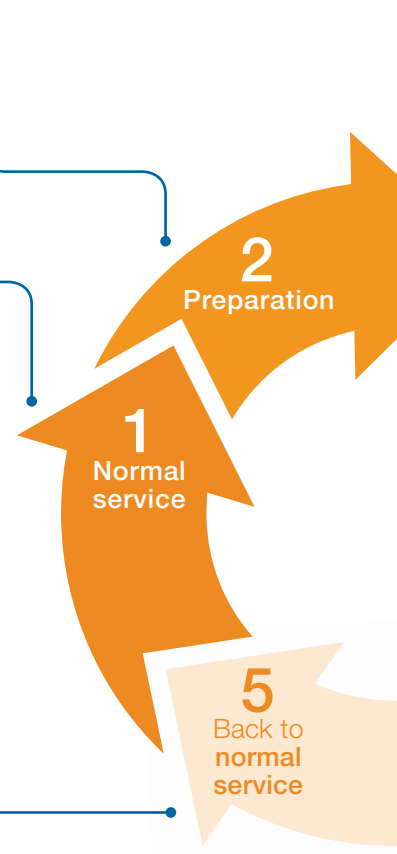

3. Test phase: Break



Removing of the lid **opens the circuit**.
The device to be tested is then isolated from the power supply (VT) and is no longer energized.

4. Simultaneous measurement and injection

Test phase: Make with 2x4 poles test plugs

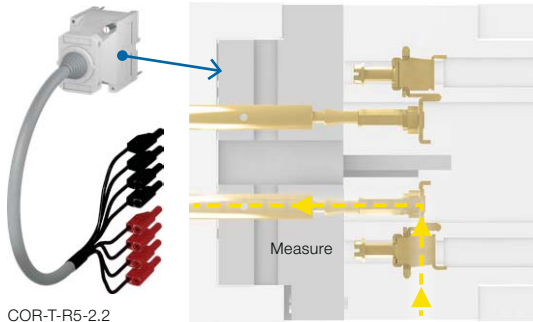

COR-T-R5-2.2

4.1 The plug is fully inserted in the socket, **the signals are derived** into the plug towards the test set.

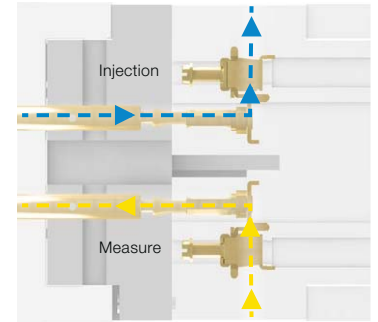

4.2 While the plug is still in place **simultaneous injection** can be realized on the equipment.

OR

4. Separated measurement and injection

Test phase: Make with 4 poles test plugs

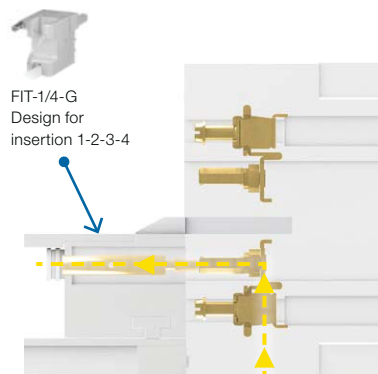

FIT-1/4-G
Design for
insertion 1-2-3-4

4.1 The plug is fully inserted in the socket, **the signals are derived** into the plug towards the test set.

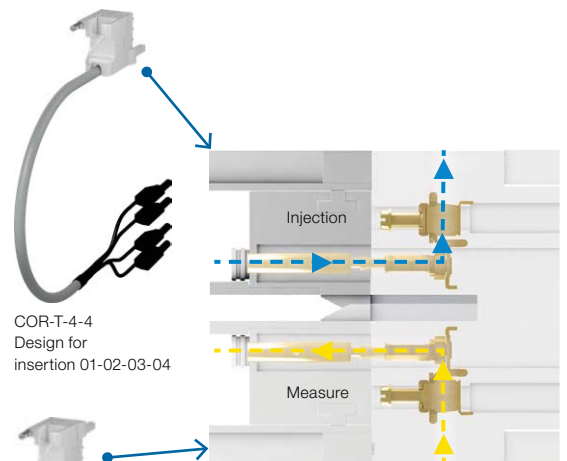

COR-T-4-4
Design for
insertion 01-02-03-04

FIT-1/4-G
Design for
insertion 1-2-3-4

4.2 While the plug is still in place, a second plug can be installed for **injection** on the equipment.

3

Test phase:
Make

4

Test phase:
Break

Voltage transformers application

ESSAILEC® sockets for voltage transformers - Break before make



TO-E-VA

Description

Opened type contacts for measurement and calibration applications.

Break before make principle:

- The connection is made thanks to the lid: the removing of the lid opens the circuit. So the device is isolated from power supply to be tested.
- The circuit is closed only when the lid is reinstalled.
- By convention, grey coding is for voltage circuits blue coding is for polarity circuits and orange coding is for trip circuits.

Main technical data

Connecting capacity		IEC 947-1
Screw clamp (VL)	Rigid: Solid/Stranded Flexible with insulated ferrule	0.2 ... 6 mm ² 0.22 ... 4 mm ²
Ring tongue (VA)	Flexible with insulated ferrule Ø lug hole size Width	0.34 ... 10 mm ² 3 mm 7.5 mm
Body	Polycarbonate	
Conductive parts	Silver-plated	
Rated voltage	400 V	
Impulse withstand voltage	4000 V	
Pollution degree	3	
Rated current	8 A	
Short-circuit current	25 A/5 s ... 800 A/25 ms	
Storage temperature range	-25 ... +70 °C	
Working temperature range	-10 ... +55 °C	
Protection without lid / with lid	IP20 / IP40	
Coding color	Grey <input type="checkbox"/> - Blue <input type="checkbox"/> - Orange <input type="checkbox"/>	

Mounting instructions

Rail		G32, TH 35-7.5, TH 35-15
Screw clamp		
Wire stripping length		9.5 mm 0.370 in
Tool		Flat screwdriver Ø 4 mm Ø 0.157 in
Torque		0.5 ... 0.8 Nm 4.4 ... 7.1 lb.in

Ordering details

Color	Type	Part Number	Pkg qty	Weight 1 pce g
Grey <input type="checkbox"/>	TO-E-VA	1SNA166743R0600	1	170
	TO-E-VA-12.12	1SNA166925R1500	1	200
Blue <input type="checkbox"/>	PO-E-VA	1SNA166759R1600	1	170
Orange <input type="checkbox"/>	DEO-E-VA	1SNA166878R0600	1	170

Flush mounting

Ring-tongue

Grey <input type="checkbox"/>	TO-E-VA	1SNA166743R0600	1	170
	TO-E-VA-12.12	1SNA166925R1500	1	200
Blue <input type="checkbox"/>	PO-E-VA	1SNA166759R1600	1	170
Orange <input type="checkbox"/>	DEO-E-VA	1SNA166878R0600	1	170

Base / Half-base mounting

Screw clamp

Grey <input type="checkbox"/>	TO-DS-VL	1SNA166741R0400	1	100
	TO-S-INF-VL-12.12	1SNA166723R2200	1	200
Blue <input type="checkbox"/>	PO-DS-VL	1SNA166757R0400	1	117

Ring-tongue

Grey <input type="checkbox"/>	TO-D-VA	1SNA166744R0700	1	139
Blue <input type="checkbox"/>	PO-D-VA	1SNA166760R1300	1	170
Orange <input type="checkbox"/>	DEO-D-VA	1SNA166874R2200	1	140

Reverse mounting

Ring-tongue

Grey <input type="checkbox"/>	TO-I-VA-2	1SNA166945R2100	1	190
-------------------------------	-----------	-----------------	---	-----

(1) Compatible with some restrictions.

(2) Compatible in base mounting only.

(3) Plug to be mounted / see customized plugs page.

Information on pre-wired plugs: Please refer to page "ESSAILEC® pre-wired plugs for voltage transformers".

Compatible products

Lid	Cover	Universal plug	Pre-wired plugs	
			2x4 poles	4 poles
CPT-2	-	FI-2/4-DIA4	COR-T-R5-2.2 (1)	COR-T-4-4
Lid + coding included			FIT-2/4-2 (3)	
CPP-2			COR-P-R1-8.8 (1)	-
CPDE-2			FIDE-2/4 (3)	
CPT-2	CPT-4 (2)	FI-2/4-DIA4	COR-T-R5-2.2 (1)	COR-T-4-4
-	Cover + coding included		FIT-2/4-2 (3)	-
CPP-2	-	FI-2/4-DIA4	COR-P-R1-8.8 (1)	
CPT-2	-	FI-2/4-DIA4	COR-T-R5-2.2 (1)	COR-T-4-4
CPP-2			COR-P-R1-8.8 (1)	
CPDE-2			FIDE-2/4 (3)	
CPT-2	-	FIT-2/4-1	FIT-2/4-1 (3)	-

Voltage transformers application

ESSAILEC® sockets for voltage transformers - Break before make

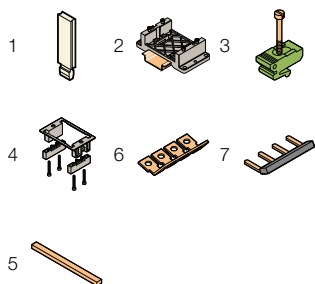

Accessories

Description	Type	Part Number	Pkg qty	Weight 1 pce g
1 Interlocking peg For 2 sockets assembly	CVABM	1SNA183436R0500	10	0.4
2 Mounting kits For TH35 rail (a)	KEM-3	1SNA166962R0000	10	24
3 For DIN 1 rail (a)	FX	1SNA167682R2300	10	20
4 For ring-tongue flush mounting (b)	KEM-1	1SNA166928R2000	50	18
6 Lateral jumper bars Compatible with ring-tongue connection only (VA) (b)	PCVA	1SNA167496R1100	10	1
7 Compatible with screw connection only (VL); IP20 (c)	PCVL	1SNA167681R2200	10	1
5 Jumper bars For two sockets screw connection type (c)	BJ-VL	1SNA167680R0500	10	1

(a) compatible with base mounting only.

(b) compatible with ring-tongue connection type socket only (VA).

(c) compatible with screw connection type socket only (VL).

Compatible products

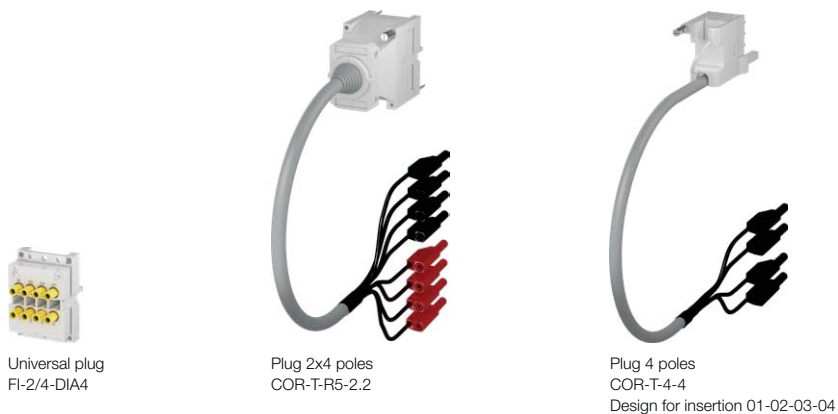

Connection technologies



Voltage transformers application

Closed contact test principle - Measurement with 4 poles test plug

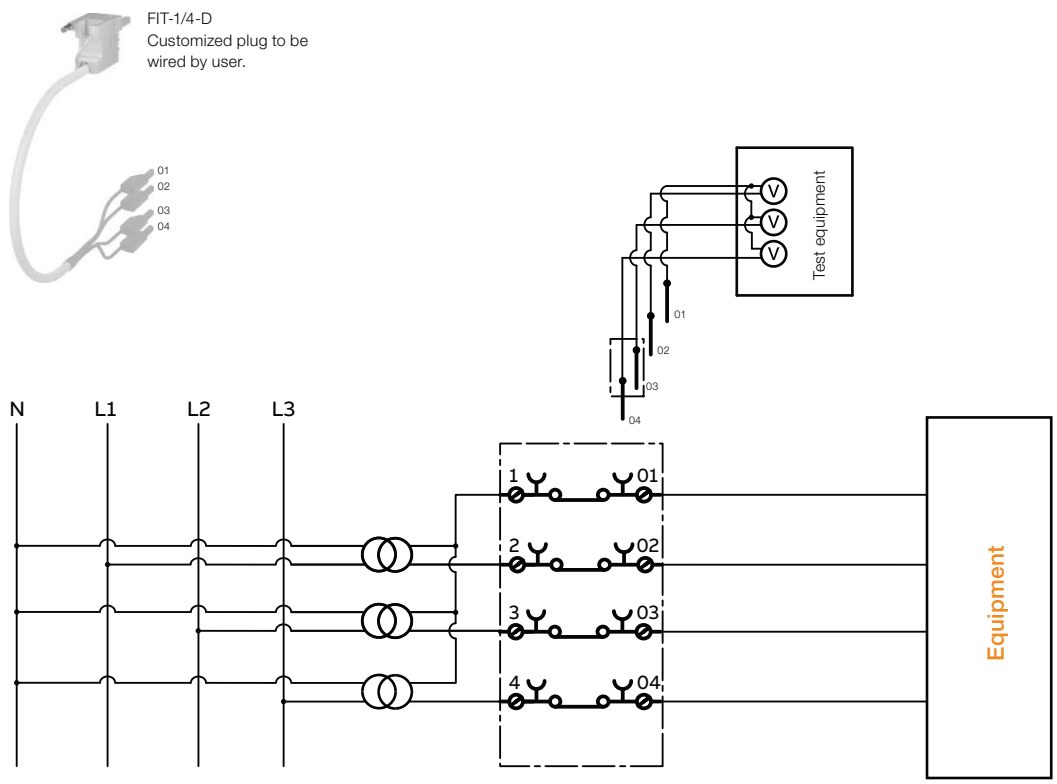



Voltage transformers application

Closed contact test principle - With 4 poles test plug

Applications

- Measurement on VT's

1. Normal service



1.1 ESSAILEC® voltage sockets allow the simultaneous testing operations of 1 to 4 independent circuits on the same socket.

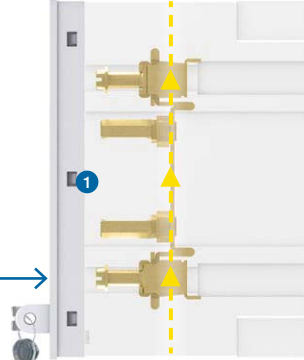

1.2 The lid is installed on the socket and can be sealed to prevent unauthorized access.

The socket has no mobile contacts (closed style) (1).

Circuit continuity is permanent, no possibility of disconnection.

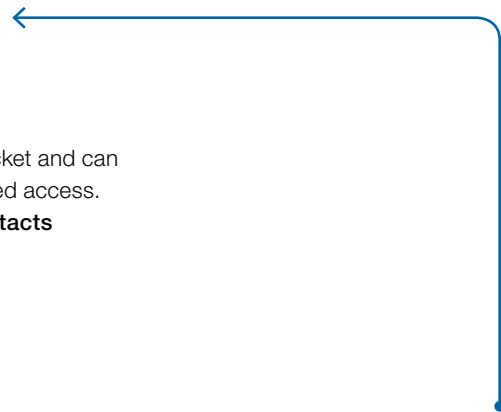

1
Normal service

4. Back to normal service



4.1 The plug is removed, and lid is put back in place, signals **never stop to flow through the socket.**

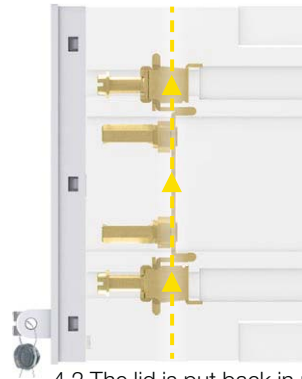
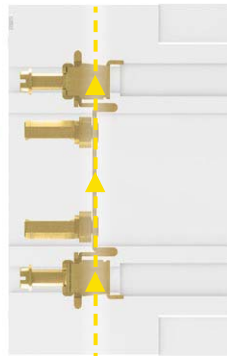

4.2 The lid is put back in place.

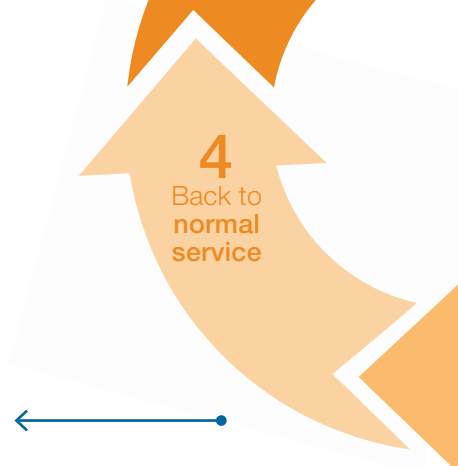

4
Back to normal service



2. Preparation: plug and lid



2.1 The lid is removed.



2.2 Connect the ESSAILEC® test plug leads to the test set.



3. Test phase: Make & Measure

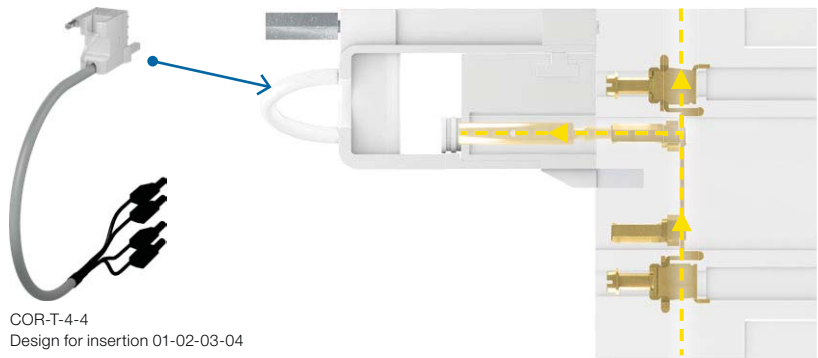

COR-T-4-4
Design for insertion 01-02-03-04

The plug is fully inserted in the socket, **the signals are derived** into the plug towards the test set.

Voltage transformers application

ESSAILEC® sockets for voltage transformers – closed contact



TF-E-VA

Description

Closed contact principle:

- The electrical connection is continuous. The circuit still closed during the testing operation.
- Closed contacts for measurement and distribution applications.
- By convention, grey coding is for voltage circuits blue coding is for polarity circuits and orange coding is for trip circuits.

Main technical data

Connecting capacity		IEC 947-1
Screw clamp (VL)	Rigid: Solid/Stranded	0.2 ... 6 mm ²
	Flexible with insulated ferrule	0.22 ... 4 mm ²
Ring tongue (VA)	Flexible with insulated ferrule	0.34 ... 10 mm ²
	Ø lug hole size	3 mm
	Width	7.5 mm
Body	Polycarbonate	
Conductive parts	Silver-plated	
Rated voltage	400 V	
Impulse withstand voltage	4000 V	
Pollution degree	3	
Rated current	8 A	
Short-circuit current	25 A/5 s ... 800 A/25 ms	
Storage temperature range	-25 ... +70 °C	
Working temperature range	-10 ... +55 °C	
Protection without lid / with lid	IP20 / IP40	
Coding color	Grey <input type="checkbox"/> - Blue <input type="checkbox"/> - Orange <input type="checkbox"/>	

Mounting instructions

Rail		G32, TH 35-7.5, TH 35-15
Screw clamp		
Wire stripping length		9.5 mm 0.370 in
Tool		Flat screwdriver Ø 4 mm Ø 0.157 in
Torque		0.5 ... 0.8 Nm 4.4 ... 7.1 lb.in

Ordering details

Color	Type	Part Number	Pkg qty	Weight 1 pce g
Flush mounting				
Ring-tongue				
Grey <input type="checkbox"/>	TF-E-VA	1SNA166745R0000	1	170
Blue <input type="checkbox"/>	PF-E-VA	1SNA166761R0000	1	170
Base / Half-base mounting				
Screw clamp				
Grey <input type="checkbox"/>	TF-DS-VL	1SNA166503R2700	1	120
Blue <input type="checkbox"/>	PF-DS-VL	1SNA166506R2200	1	117
Ring-tongue				
Grey <input type="checkbox"/>	TF-D-VA	1SNA166746R0100	1	119
Blue <input type="checkbox"/>	PF-D-VA	1SNA166762R0100	1	140
Orange <input type="checkbox"/>	DEF-D-VA	1SNA166896R1100	1	140

Compatible products

Lid	Cover	Universal plug	Pre-wired plugs	
			2x4 poles	4 poles
CPT-1	-	-	-	COR-T-4-4
CPP-1	-	-	-	FIP-1/4-D (1) FIP-1/4-G (1)
CPT-1	CPT-5 (2)	-	-	COR-T-4-4
CPP-1	-	-	-	FIP-1/4-D (1) FIP-1/4-G (1)
CPT-1	-	-	-	COR-T-4-4
CPP-1	-	-	-	FIP-1/4-D (1) FIP-1/4-G (1)
CPDE-1	-	-	-	FIP-1/4-G (1)

(1) Plug to be mounted / see customized plugs page.

(2) Compatible in base mounting only.

Information on pre-wired plugs: Please refer to page "ESSAILEC® pre-wired plugs for voltage transformers".



Voltage transformers application

ESSAILEC® sockets for voltage transformers – closed contact

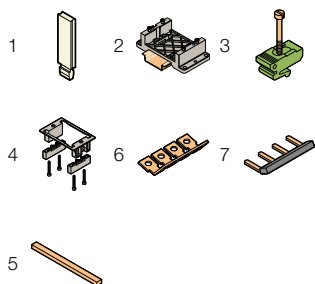

Accessories

Description	Type	Part Number	Pkg qty	Weight 1 pce g
1 Interlocking peg For 2 sockets assembly	CVABM	1SNA183436R0500	10	0.4
2 Mounting kits For TH35 rail (a)	KEM-3	1SNA166962R0000	10	24
3 For DIN 1 rail (a)	FX	1SNA167682R2300	10	20
4 For ring-tongue flush mounting (b)	KEM-1	1SNA166928R2000	50	18
6 Lateral jumper bars Compatible with ring-tongue connection only (VA) (b)	PCVA	1SNA167496R1100	10	1
7 Jumper bars Compatible with screw connection only (VL); IP20 (c)	PCVL	1SNA167681R2200	10	1
5 Jumper bars For two sockets screw connection type (c)	BJ-VL	1SNA167680R0500	10	1

(a) compatible with base mounting only.

(b) compatible with ring-tongue connection type socket only (VA).

(c) compatible with screw connection type socket only (VL).

Compatible products



Lid
CPC-1

Cover
CPC-7



Plug 4 poles
COR-T-4-4
Design for insertion 01-02-03-04

Connection technologies



Ring-tongue



Screw clamp

Voltage transformers application

ESSAILEC® sockets for voltage transformers – independent circuits



TT4-S-VL-INF

Description

Four independent circuits for voltage measurement.

Test directly performed on the four built-in dia. 4mm test sockets (no plug required).

Test sockets color coding :

- U1- brown,
- U2-black,
- U3-red,
- U4-blue.

The socket is supplied with a compact cover and sealing option (no coding required).

Main technical data

Connecting capacity		IEC 947-1
Screw clamp (VL)	Rigid: Solid/Stranded	0.2 ... 6 mm ²
	Flexible with insulated ferrule	0.22 ... 4 mm ²
	Flexible with non insulated ferrule	0.22 ... 4 mm ²
Body		Polycarbonate
Conductive parts		Silver-plated
Rated voltage		400 V
Impulse withstand voltage		4000 V
Pollution degree		3
Rated current		8 A
Short-circuit current		25 A/5 s ... 800 A/25 ms
Storage temperature range		-25 ... +70 °C
Working temperature range		10 ... +55 °C
Protection without cover/ lid		IP20

Mounting instructions

Rail		TH 35-7.5, TH 35-15
Wire stripping length		9.5 mm 0.370 in
Tool		Flat screwdriver Ø 4 mm Ø 0.157 in
Torque		0.5 ... 0.8 Nm 4.4 ... 7.1 lb.in

Ordering details

Color	Type	Part Number	Pkg qty	Weight 1 pce g
Grey	<input type="checkbox"/> TT4-S-VL-INF	1SNA166972R0000	40	114

Base / Half-base mounting

Grey	<input type="checkbox"/> TT4-S-VL-INF	1SNA166972R0000	40	114
------	---------------------------------------	-----------------	----	-----

Compatible products

Lid / Cover	Cover
Included	included

Information on pre-wired plugs: Please refer to page "ESSAILEC® pre-wired plugs for voltage transformers".

Accessories

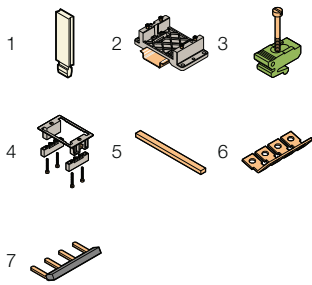

Description	Type	Part Number	Pkg qty	Weight 1 pce g
1 Interlocking peg For 2 sockets assembly	CVABM	1SNA183436R0500	10	0.4
2 Mounting kits For TH35 rail (a)	KEM-3	1SNA166962R0000	10	24
3 For DIN 1 rail (a)	FX	1SNA167682R2300	10	20
4 For ring-tongue flush mounting (b)	KEM-1	1SNA166928R2000	50	18
5 Jumper bars For two sockets screw connection type (c)	BJ-VL	1SNA167680R0500	10	1
6 Lateral jumper bars Compatible with ring-tongue connection only (VA) (b)	PCVA	1SNA167496R1100	10	1
7 Compatible with screw connection only (VL); IP20 (c)	PCVL	1SNA167681R2200	10	1

(a) compatible with base mounting only.

(b) compatible with ring-tongue connection type socket only (VA).

(c) compatible with screw connection type socket only (VL).

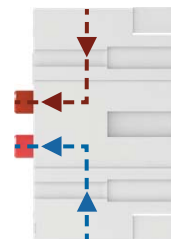
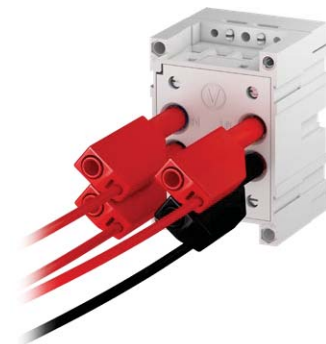

Side view left



Side view right

Voltage transformers application

ESSAILEC® pre-wired plugs for voltage transformers

Description

- Standard voltage plugs are compatible with ESSAILEC® voltage sockets.
- Plugs are ready to use with contact pins (BRE...) , coding, cables and test plugs assembled to ease your test operations.

Main technical data

Connecting capacity	IEC 947-1
Body	Polycarbonate
Conductive parts	Silver-plated
Rated voltage	400 V
Impulse withstand voltage	4000 V
Pollution degree	3
Rated current	15 A
Short-circuit current	25 A/5 s ... 800 A/25 ms
Storage temperature range	-25 ... +70 °C
Working temperature range	-10 ... +55 °C

Ordering details

Description	Type	Part Number	Pkg qty	Weight 1 pce g
-------------	------	-------------	---------	----------------

Universal plugs

 Plug 2x4 pins, with direct insertion Ø 4 mm test plug	FI-2/4-DIA4	1SNA167936R1100	1	62
---	-------------	-----------------	---	----

Compatible products

Socket

TC-E-VA
 TC-E-VA-2.2
 TC-E-VA-R2-2.2
 TC-DS-VL
 TC-S-INF-VL-2.2
 TC-D-VA
 TC-TH35-VL
 TC-E-C5A-2.2
 TO-E-VA
 TO-E-VA-12.12
 TO-DS-VL
 TO-S-INF-VL-12.12
 TO-D-VA
 PC-E-VA
 PC-E-VA-8.8
 PC-DS-VL
 PC-D-VA
 PO-E-VA
 PO-DS-VL
 PO-D-VA
 DEO-E- A
 DEO-D-VA

Continue on next page

Voltage transformers application

ESSAILEC® pre-wired plugs for voltage transformers



Ordering details

Description	Type	Part Number	Pkg qty	Weight 1 pce g	Compatible products Socket
Plug 2x4 poles					
1 plug 2x4 pins PRECODED 2.2 / Grey 4 x Ø 4 mm test plugs / Black 4 x Ø 4 mm test plugs / Red Conductors section: 2.5 mm ² cable length: 2 m / 79"	COR-T-R5-2.2	1SNA167933R1600	1	1070	TC-E-VA TC-E-VA-2.2 TC-E-VA-R2-2.2 TC-DS-VL TC-S-INF-VL-2.2 TC-D-VA TC-TH35-VL TC-E-C5A-2.2 TO-E-VA TO-E-VA-12.12 TO-DS-VL TO-S-INF-VL-12.12 TO-D-VA
1 plug 2x4 pins PRECODED 8.8 / Blue 4 x Ø 4 mm test plugs / Black 4 x Ø 4 mm test plugs / Red Conductors section: 2.5 mm ² cable length: 2 m / 79"	COR-P-R1-8.8	1SNA166978R0000	1	1080	PC-E-VA PC-E-VA-8.8 PC-DS-VL PC-D-VA PO-E-VA PO-DS-VL PO-D-VA PC-E-VA PC-E-VA-8.8 PC-DS-VL PC-D-VA PO-E-VA PO-DS-VL PO-D-VA
Plug 4 poles					
1 plug 4 pins / Grey Design for insertion 01-02-03-04 (D. design.) 4 x Ø 4 mm test plugs / Black Conductors section: 2.5 mm ² cable length: 2 m / 79"	COR-T-4-4	1SNA167935R1000	1	500	TC-E-VA TC-E-VA-2.2 TC-E-VA-R2-2.2 TC-DS-VL TC-S-INF-VL-2.2 TC-D-VA TC-TH35-VL TC-E-C5A-2.2 TO-E-VA TO-E-VA-12.12 TO-DS-VL TO-S-INF-VL-12.12 TO-D-VA TF-E-VA TF-DS-VL TF-D-VA

Voltage transformers application

ESSAILEC® customized plugs

Description

To create a customized ESSAILEC® plug, according to the current socket chosen:

- Select a plug,
- Add contact pins (BRE...) and coding pins (COP...) if necessary,
- Choose the test plugs required by the measurement tool.

Ordering details

Description	Color	Type	Part Number	Pkg qty	Weight 1 pce g
-------------	-------	------	-------------	---------	----------------



1 pole plug with contact pins

Plug 2 poles with 2.5 mm ² contact pins (BRE-T-2.5), without coding pins	Grey	<input type="checkbox"/> FIT-2/1-1	1SNA166821R1500	1	30
	Red	<input checked="" type="checkbox"/> FIT-2/1-2	1SNA166644R0300	1	30

Compatible products

Socket

TC-E-VA
TC-E-VA-2.2
TC-E-VA-R2-2.2
TC-DS-VL
TC-S-INF-VL-2.2
TC-D-VA
TC-TH35-VL
TC-E-C5A-2.2
TO-E-VA
TO-E-VA-12.12
TO-DS-VL
TO-S-INF-VL-12.12
TO-D-VA
TO-I-VA-2
PC-E-VA
PC-E-VA-8.8
PC-DS-VL
PC-D-VA
PO-E-VA
PO-DS-VL
PO-D-VA
DEO-E-A

Plugs without contact pins (contact pins BRE..., to be ordered separately)

2x4 poles



Plugs 2x4 poles, long cover, with 2 coding pins (COP-FI-1) and 8 locking pin. Contacts pins (BRE-T...) to be ordered separately.	Grey	<input type="checkbox"/> FIT-2/4-2	1SNA166937R1100	1	105
	Blue	<input checked="" type="checkbox"/> FIP-2/4-2	1SNA166939R2300	1	105
Plug 2 poles with 2.5 mm ² contact pins (BRE-T-2.5), without coding pins	Orange	<input checked="" type="checkbox"/> FIDE-2/4-2	1SNA166943R2700	1	105

TC-E-VA
TC-E-VA-2.2
TC-E-VA-R2-2.2
TC-DS-VL
TC-S-INF-VL-2.2
TC-D-VA
TC-TH35-VL
TC-E-C5A-2.2
TO-E-VA
TO-E-VA-12.12
TO-DS-VL
TO-S-INF-VL-12.12
TO-D-VA
PC-E-VA
PC-E-VA-8.8
PC-DS-VL
PC-D-VA
PO-E-VA
PO-DS-VL
PO-D-VA
DEO-E-A
DEO-D-VA

Continue on next page

Voltage transformers application

ESSAILEC® customized plugs

Ordering details



Description	Color	Type	Part Number	Pkg qty	Weight 1 pce g
Plugs 2x4 poles, short cover, with 2 coding pins (COP-FI-1) and 8 locking pins. Contacts pins (BRE-T...) to be ordered separately.	Grey	<input type="checkbox"/> FIT-2/4-1	1SNA166550R0100	1	91
	Blue	<input type="checkbox"/> FIP-2/4-1	1SNA166559R0600	1	91
	Orange	<input type="checkbox"/> FIDE-2/4	1SNA166877R2500	1	91
Plug 4 poles - insertion 01-02-03-04, with 1 coding pin (COP-FI-1) and 4 locking pins. Contacts pins (BRE-T...) to be ordered separately.	Grey	<input type="checkbox"/> FIT-2/4-I	1SNA166672R0700	1	60



4 Poles



Plug 4 poles - insertion 1-2-3-4, with 1 coding pin (COP-FI-1) and 4 locking pins. Contacts pins (BRE-T...) to be ordered separately.	Grey	<input type="checkbox"/> FIT-1/4-G	1SNA166547R2200	1	60
	Blue	<input type="checkbox"/> FIP-1/4-G	1SNA166556R2300	1	60
	Orange	<input type="checkbox"/> FIDE-1/4-G	1SNA166898R2300	1	40

Compatible products

Socket

TC-E-VA
TC-E-VA-2.2
TC-E-VA-R2-2.2
TC-DS-VL
TC-S-INF-VL-2.2
TC-D-VA
TC-TH35-VL
TC-E-C5A-2.2
TO-E-VA
TO-E-VA-12.12
TO-DS-VL
TO-S-INF-VL-12.12
TO-D-VA

PC-E-VA
PC-E-VA-8.8
PC-DS-VL
PC-D-VA
PO-E-VA
PO-DS-VL
PO-D-VA

DEO-E-A
DEO-D-VA

TO-I-VA-2

TC-E-VA
TC-E-VA-2.2
TC-E-VA-R2-2.2
TC-DS-VL
TC-S-INF-VL-2.2
TC-D-VA
TC-TH35-VL
TC-E-C5A-2.2
TO-E-VA
TO-E-VA-12.12
TO-DS-VL
TO-S-INF-VL-12.12
TO-D-VA
TF-E-VA
TF-DS-VL
TF-D-VA

PC-E-VA
PC-E-VA-8.8
PC-DS-VL
PC-D-VA
PO-E-VA
PO-DS-VL
PO-D-VA
PF-E-VA
PF-DS-VL
PF-D-VA

DEO-D-VA
DEF-D-VA
DEO-E-VA

Continue on next page

Voltage transformers application

ESSAILEC® customized plugs



Ordering details

Description	Color	Type	Part Number	Pkg qty	Weight 1 pce g
Plug 4 poles - insertion 01-02-03-04, with 1 coding pin (COP-FI-1) and 4 locking pins. Contacts pins (BRE-T...) to be ordered separately.	Grey <input type="checkbox"/>	FIT-1/4-D	1SNA166546R2100	1	60
	Blue <input type="checkbox"/>	FIP-1/4-D	1SNA166555R2200	1	60
	Orange <input type="checkbox"/>	FIDE-1/4-D	1SNA166897R1200	1	40

Compatible products

Socket

TC-E-VA
 TC-E-VA-2.2
 TC-E-VA-R2-2.2
 TC-DS-VL
 TC-S-INF-VL-2.2
 TC-D-VA
 TC-TH35-VL
 TC-E-C5A-2.2
 TO-E-VA
 TO-E-VA-12.12
 TO-DS-VL
 TO-S-INF-VL-12.12
 TO-D-VA
 TF-E-VA
 TF-DS-VL
 TF-D-VA
 PC-E-VA
 PC-E-VA-8.8
 PC-DS-VL
 PC-D-VA
 PO-E-VA
 PO-DS-VL
 PO-D-VA
 PF-E-VA
 PF-DS-VL
 PF-D-VA
 DEO-D-VA
 DEF-D-VA
 DEO-E-VA

Voltage transformers application

ESSAILEC® customized plugs

Accessories

Description	Type	Part Number	Pkg qty	Weight 1 pce g	Compatible products Socket
BRE contact pins					
Pin 0.34 mm ²	BRE-T-0.34	1SNA168160R1400	50	2	-
Pin 0.75 mm ²	BRE-T-0.75	1SNA167779R1300	50	2.9	-
Pin 1 mm ²	BRE-T-1	1SNA164921R1700	50	3	-
Pin 1.5 mm ²	BRE-T-1.5	1SNA164922R1000	50	2.6	-
Pin 2.5 mm ²	BRE-T-2.5	1SNA164923R1100	50	2	-
Pin 4 mm ²	BRE-T-4	1SNA166980R0000	100	3	-
Pin 6 mm ²	BRE-T-6	1SNA168147R0300	50	3	-
Tools for contact pins					
1 Pin extraction tool	EXBR1	1SNA167008R0300	1	24	-
2 Crimping tool for BRE pins 1 to 2.5 mm ² (1)	PSC	1SNA173181R1300	1	478	-
3 Locking sleeve for contact pin	DLVR	1SNA167971R2400	10	0.4	-
Dia 4 mm test plugs					
4 IP20 with mobile protection	FC4-1	1SNA167927R1000	10	11	-
5 IP20 with permanent protection	FC4-5	1SNA167931R1400	10	10	-
Coding pins					
6 Plug coding pin	COP-FI-1	1SNA167378R1100	10	2.3	-

(1) Referring to 1SNC169040D1702 to find other crimping tools

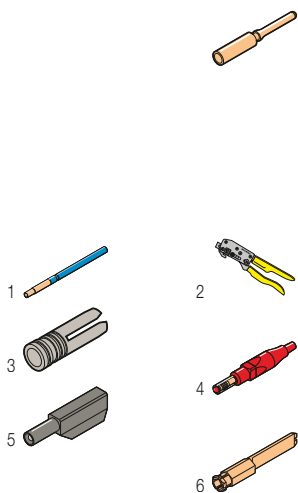

Pin installation on plugs

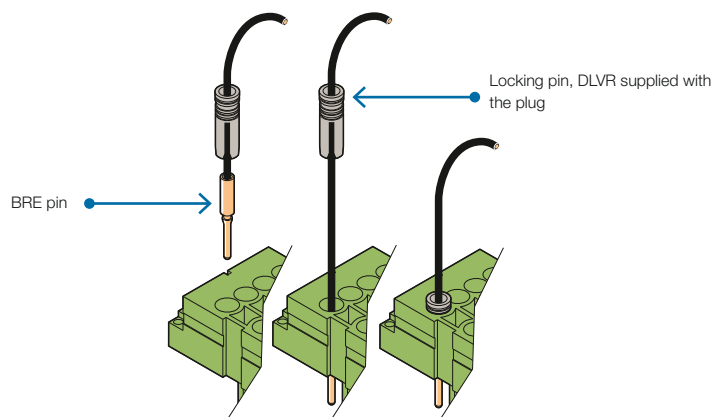

For all applications

ESSAILEC® protection lids and covers

Description

During normal operation, lids and covers ensure protection of the test sockets from dust and unauthorized use.

According to the mounting choice, two options available:

- a lid for all types of mounting
- a cover required for base mounting ("S/DS" mounting coding)

In the case of opened contacts sockets, electrical continuity covers or lids are required. The electrical continuity is provided thanks to inner pins and linking bar.

Main technical data

Protection with cover / lid	IP40
-----------------------------	------

Ordering details

Description	Color	Type	Part Number	Pkg qty	Weight 1 pce g
-------------	-------	------	-------------	---------	----------------

Lid

Protecting lid for current sockets	Green	<input checked="" type="checkbox"/> CPC-1	1SNA166578R0100	1	30
Protecting lid for voltage sockets	Grey	<input type="checkbox"/> CPT-1	1SNA166646R0500	1	30
Protecting lid for trip sockets	Blue	<input type="checkbox"/> CPP-1	1SNA166647R0600	1	30
Protecting lid for polarity sockets	Orange	<input type="checkbox"/> CPDE-1	1SNA166876R2400	1	30
Lid for RJ45 socket (spare part)	Grey	<input type="checkbox"/> CPT-RJ45	1SNA167002R0000	1	25.4

Lid with electrical continuity

Protecting lid for voltage sockets	Grey	<input type="checkbox"/> CPT-2	1SNA166577R2000	1	40
Protecting lid for polarity sockets	Blue	<input type="checkbox"/> CPP-2	1SNA166645R0400	1	40
Protecting lid for trip sockets	Orange	<input type="checkbox"/> CPDE-2	1SNA166926R1600	1	40

Cover

Protecting cover for current sockets	Green	<input checked="" type="checkbox"/> CPC-7 (1)	1SNA166734R2500	1	66
Protecting cover for voltage sockets	Grey	<input type="checkbox"/> CPT-5	1SNA166930R2600	1	66

Cover with electrical continuity

Protecting cover for voltage sockets	Grey	<input type="checkbox"/> CPT-4	1SNA166733R2400	1	78
--------------------------------------	------	--------------------------------	-----------------	---	----

(1) CPC-7 is compatible with CC-S-INF-VL-6.6 sockets.





Description

- Designed for high density wiring inside panels.
- Alternative to large terminal strips.
- Allows easy circuits disconnection without wiring modification.

Multi-circuit blocks can be mounted side by side for compact panel board wiring in replacement of large terminal strip.

Main technical data

Connecting capacity		IEC 947-1
Socket	Quick connect (C5A) Flexible with insulated ferrule	0.5 ... 0.8 Nm 2.5 mm ²
Plug		Pin BRE
Body		Polycarbonate
Conductive parts		Silver-plated
Rated voltage		400 V
Impulse withstand voltage		4000 V
Pollution degree		3
Rated current		8 A
Short-circuit current		25 A/5 s ... 800 A/25 ms
Storage temperature range		-25 ... +70 °C
Working temperature range		-10 ... +55 °C
Protection without cover/ lid		IP20 / IP40

Mounting instructions

Wire stripping length 9.5 mm
0.370 in

Ordering details

Color	Type	Part Number	Pkg qty	Weight 1 pce g
-------	------	-------------	---------	----------------

Sockets

Half-base mounting				
Grey	<input type="checkbox"/> M10-D-C5A	1SNA166513R1000	10	60
Extension mounting				
Grey	<input type="checkbox"/> M10-P-C5A	1SNA166772R0300	10	66
Rack mounting				
Grey	<input type="checkbox"/> M10-R-C5A	1SNA166566R2500	10	60
Reverse mounting				
Grey	<input type="checkbox"/> M10-I-C5A-1	1SNA166774R0500	10	100
	<input type="checkbox"/> M20-I-C5A	1SNA166777R0000	1	190

Plugs

Grey	<input type="checkbox"/> FIM10-1	1SNA166516R1300	10	55
	<input type="checkbox"/> FIM10-R	1SNA166573R2400	1	54
	<input type="checkbox"/> FIM10-I-1	1SNA166574R2500	1	30
	<input type="checkbox"/> FIM20-I	1SNA166576R2700	1	53

Compatible products

Plug	Socket
FIM10-1	-
-	-
FIM10-R	-
FIM10-I-1	-
FIM20-I	-
-	M10-D-C5A
-	M10-R-C5A
-	M10-I-C5A-1
-	M20-I-C5A

The various accessories necessary for each mounting option are supplied with the socket as well as the 2 coding pins COP-E-1 (see coding section). The BRT contacts pins are to be ordered separately.

Accessories

Description	Type	Part Number	Pkg qty	Weight 1 pce g
For sockets				
1 For 2 sockets assembly	CVABM	1SNA183436R0500	10	0.4
For plugs				
2 Pin 0.34 mm ²	BRE-T-0.34	1SNA168160R1400	50	2
Pin 0.75 mm ²	BRE-T-0.75	1SNA167779R1300	50	2.9
Pin 1 mm ²	BRE-T-1	1SNA164921R1700	50	3
Pin 1.5 mm ²	BRE-T-1.5	1SNA164922R1000	50	2.6
Pin 2.5 mm ²	BRE-T-2.5	1SNA164923R1100	50	2
Pin 6 mm ²	BRE-T-6	1SNA168147R0300	50	3
3 Pin extraction tool	EXBR1	1SNA167008R0300	1	24
4 Crimping tool for BRE pins 1 to 2.5 mm ² (1)	PSC	1SNA173181R1300	1	478

(1) Referring to 1SNC169040D1702 to find other crimping tools

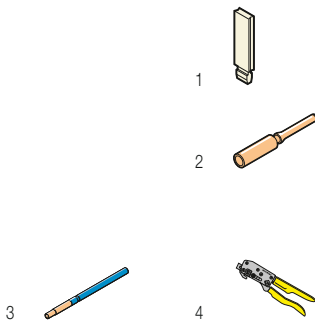
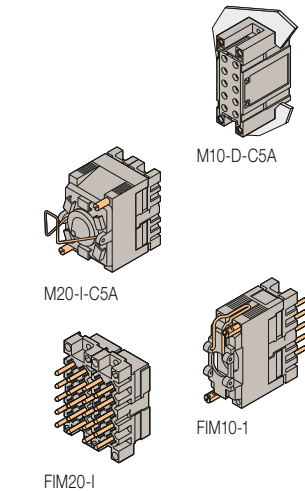

Mounting instructions

Mounting instructions for coding	58
Outer dimensions, mounting instructions	60

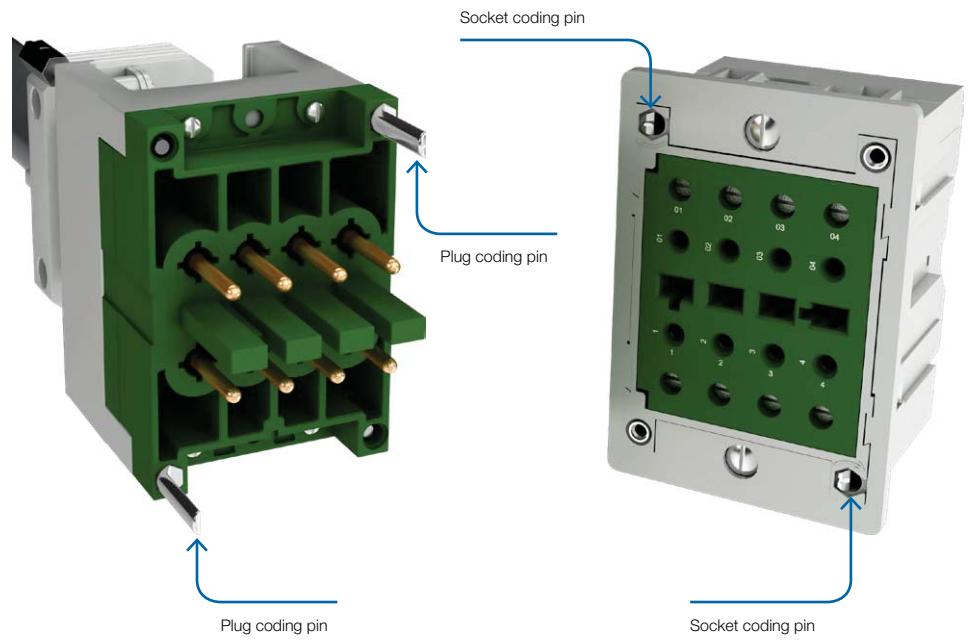

Socket coding

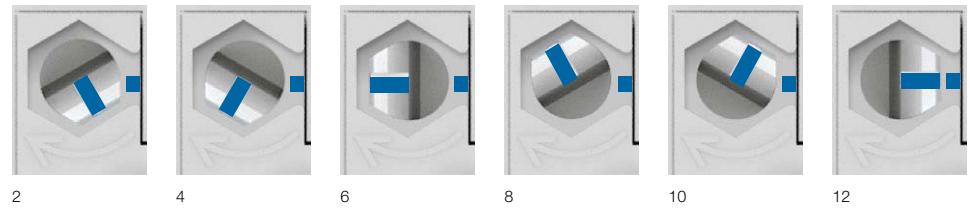

Plug coding

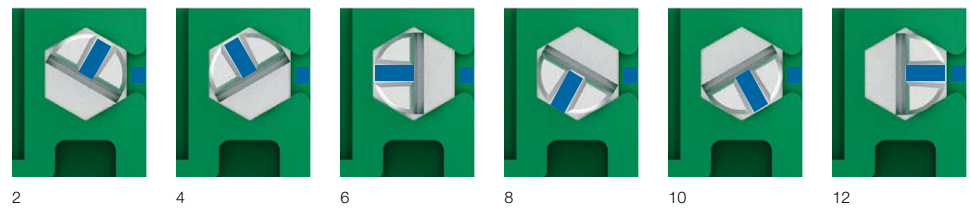

These numbers correspond to the coding information

For instance:

CC-E-VA-6.6 corresponds to COR-C-R4-6.6

TC-E-VA-2.2 corresponds to COR-T-R5-2.2

Ordering details

Description	Type	Part Number	Pkg qty	Weight kg
Socket coding pin	COP-E-1	1SNA167379R1200	10	2.3
Plug coding pin	COP-FI-1	1SNA167378R1100	10	2.3

How to insert the coding pins?

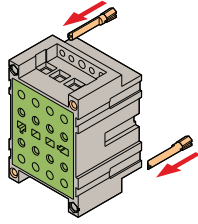

Step 1 - Socket

Choose a coding code for the socket. Then, insert the coding pin (COP-E-1) from below into the socket.

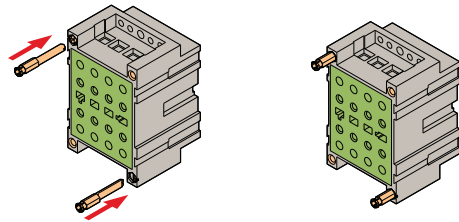

Step 2 - Plug

In order to guarantee a perfect compatibility between the socket coding and the plug coding, you have to:

1. Insert the coding pin for the plug (COP-FI-1) inside the socket.

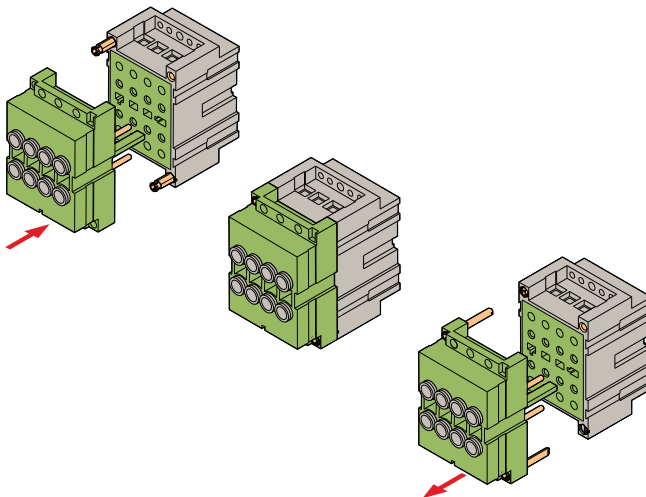

2. On a second time, connect the plug on the socket to insert the plug coding within the plug.

Sockets

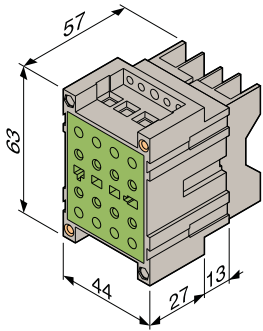

Half-base mounting

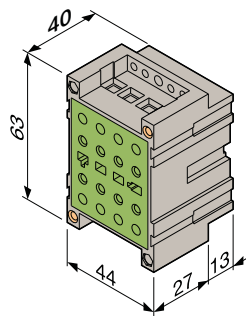

Rack mounting

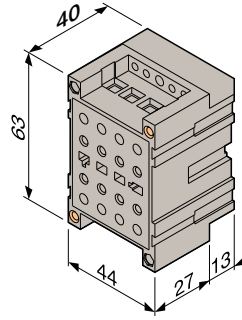

Base mounting

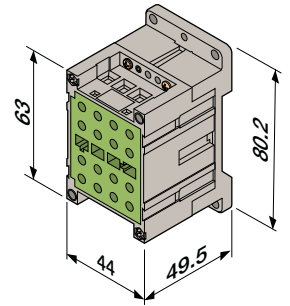

Base mounting with KEM-3

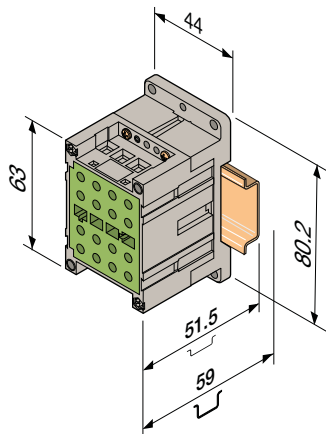

TH35 rail mounting

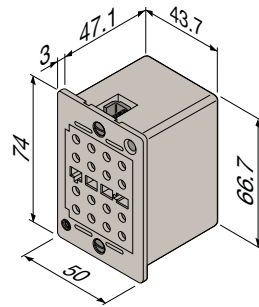

RJ45

Lids and covers

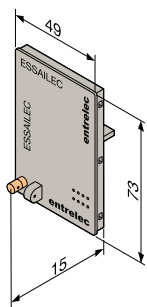

Lid

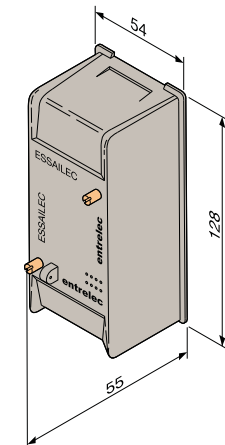

Cover

Plugs

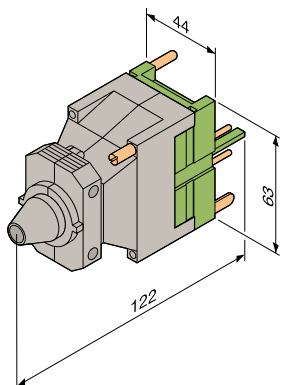

Plug 2x4 poles long cover

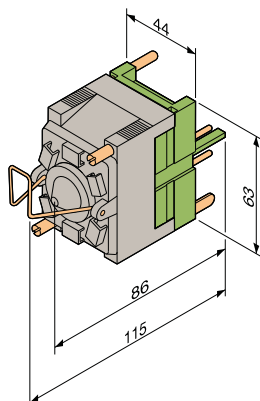

Plug 2x4 poles short cover

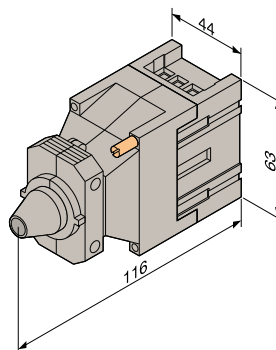

Reverse mounting

ESSAILEC®

Outer dimensions, mounting instructions

Sockets

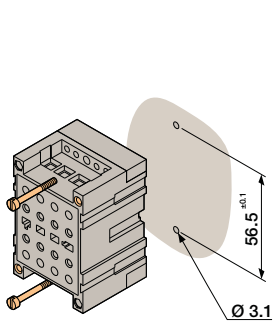

Base mounting
0.5 Nm < Tightening torque
< 0.8 Nm.

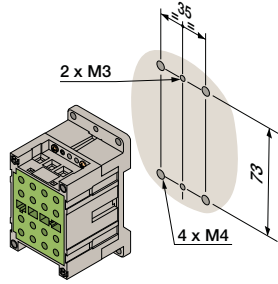

Base mounting

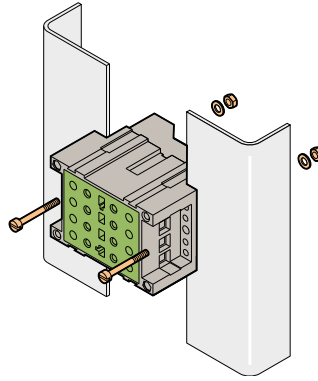

Flush mounting

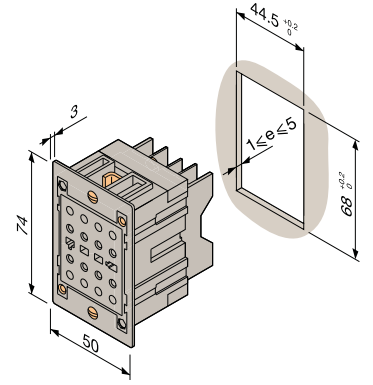

Flush mounting
The flush mounting kit must be mounted on the socket prior to the installation on the panel.
Tightening torque = 0.5 Nm maxi.

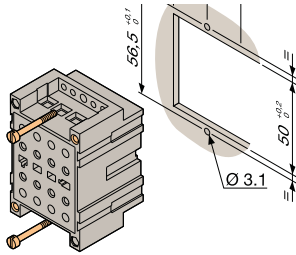

Half-base mounting - Rack mounting
The rack mounting is supplied with 2 additional guiding pins.
0.5 Nm < Tightening torque < 0.8 Nm.

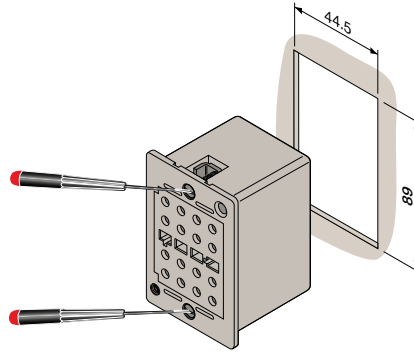

Flush mounting (RJ45)

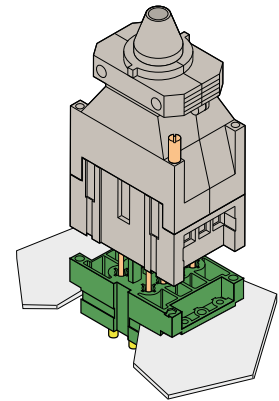

Reverse mounting

Lids and covers

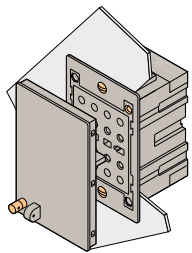

Flush mounting

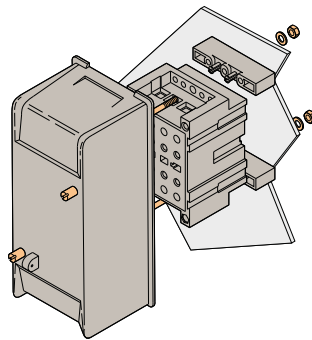

Base mounting

ESSAILEC® multicircuits

Outer dimensions, mounting instructions

Outer dimensions

Sockets

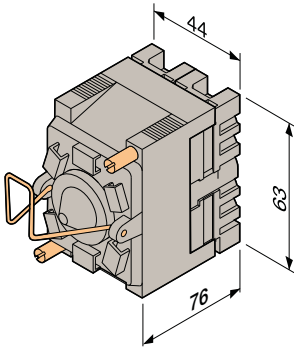

M20-I-C5A
20 points multicircuits half-base reverse mounting socket

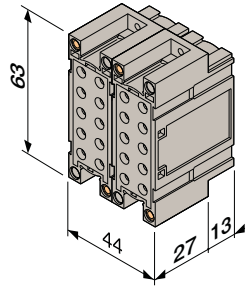

M20-C5A
20 points multicircuits half-base mounting socket

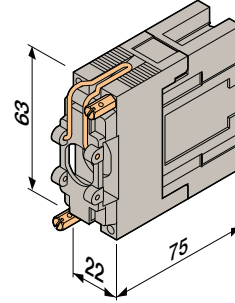

M10-I-C5A-1
10 points multicircuits half-base reverse mounting socket

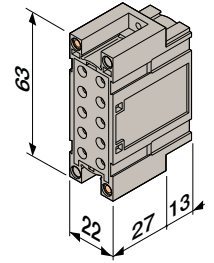

M10-D-C5A
10 points multicircuits half-base mounting socket

Plugs

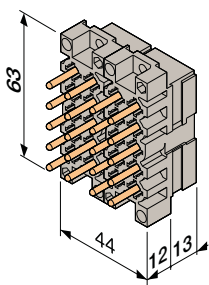

FIM20-I
20 points multicircuits half-base reverse mounting plug

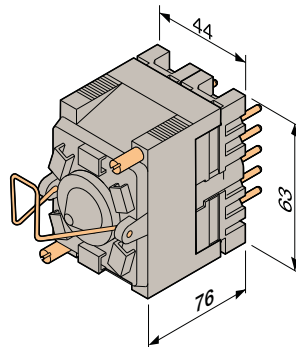

FIM20
20 points multicircuits half-base mounting plug

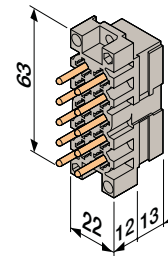

FIM10-I-1
10 points multicircuits half-base reverse mounting plug

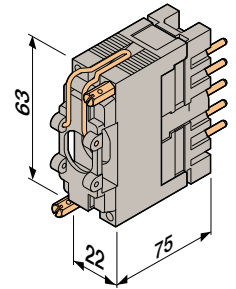

FIM10-1
10 points multicircuits half-base mounting plug

Mounting instructions

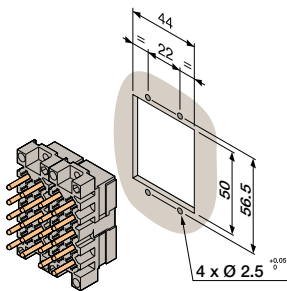

20 points multicircuits half-base reverse mounting plug

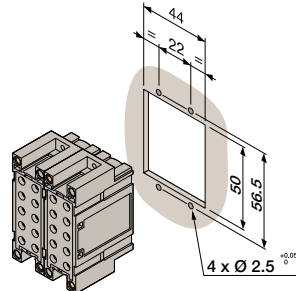

20 points multicircuits half-base mounting socket

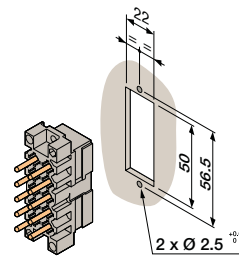

10 points multicircuits half-base reverse mounting plug

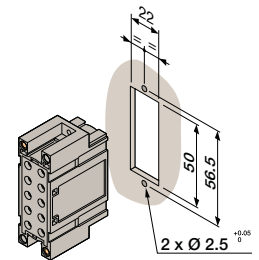

10 points multicircuits half-base mounting socket

1SNC169102250201

Index

Part Number classification

Part Number	Type	Page	Part Number	Type	Page	Part Number	Type	Page
1SNA164921R1700	BRE-T-1	54	1SNA166759R1600	PO-E-VA	40	1SNA167680R0500	BJ-VL	23
1SNA164922R1000	BRE-T-1.5	54	1SNA166760R1300	PO-D-VA	40	1SNA167681R2200	PCVL	23
1SNA164923R1100	BRE-T-2.5	54	1SNA166761R0000	PF-E-VA	46	1SNA167682R2300	FX	23
1SNA166503R2700	TF-DS-VL	46	1SNA166762R0100	PF-D-VA	46	1SNA167690R0700	FCB-1	26
1SNA166506R2200	PF-DS-VL	46	1SNA166763R0200	PC-E-VA	34	1SNA167692R2500	FCB-2	26
1SNA166513R1000	M10-D-C5A	56	1SNA166764R0300	PC-D-VA	34	1SNA167697R2200	CA	26
1SNA166516R1300	FIM10-1	56	1SNA166772R0300	M10-P-C5A	56	1SNA167779R1300	BRE-T-0.75	54
1SNA166523R1200	CC-R-VA	22	1SNA166774R0500	M10-I-C5A-1	56	1SNA167927R1000	FC4-1	26
1SNA166525R1400	FIC-2/4-1	26	1SNA166777R0000	M20-I-C5A	56	1SNA167931R1400	FC4-5	26
1SNA166529R2000	FIC-2/4-R	26	1SNA166778R1100	COR-C-R2-6.6	24	1SNA167932R1500	COR-C-R4-6.6	24
1SNA166546R2100	FIT-1/4-D	53	1SNA166819R2300	FIC-2/1-1	26	1SNA167933R1600	COR-T-R5-2.2	50
1SNA166547R2200	FIT-1/4-G	52	1SNA166821R1500	FIT-2/1-1	51	1SNA167934R1700	COR-C-R5-6.6	24
1SNA166550R0100	FIT-2/4-1	52	1SNA166874R2200	DEO-D-VA	40	1SNA167935R1000	COR-T-4-4	50
1SNA166555R2200	FIP-1/4-D	53	1SNA166876R2400	CPDE-1	55	1SNA167936R1100	FI-2/4-DIA4	49
1SNA166556R2300	FIP-1/4-G	52	1SNA166877R2500	FIDE-2/4	52	1SNA167937R0000	FIC-2/4-DIA4	25
1SNA166559R0600	FIP-2/4-1	52	1SNA166878R0600	DEO-E-VA	40	1SNA167971R2400	DLVR	26
1SNA166566R2500	M10-R-C5A	56	1SNA166896R1100	DEF-D-VA	46	1SNA167981R1700	DI	26
1SNA166573R2400	FIM10-R	56	1SNA166897R1200	FIDE-1/4-D	53	1SNA168146R0200	BRE-C-6	26
1SNA166574R2500	FIM10-I-1	56	1SNA166898R2300	FIDE-1/4-G	52	1SNA168147R0300	BRE-T-6	54
1SNA166576R2700	FIM20-I	56	1SNA166925R1500	TO-E-VA-12.12	40	1SNA168160R1400	BRE-T-0.34	54
1SNA166577R2000	CPT-2	55	1SNA166926R1600	CPDE-2	55	1SNA173181R1300	PSC	26
1SNA166578R0100	CPC-1	55	1SNA166928R2000	KEM-1	23	1SNA183436R0500	CVABM	23
1SNA166589R2500	FIC-2/4-1	26	1SNA166930R2600	CPT-5	55	1SNA205876R0400	BRE-C-4	26
1SNA166625R2000	CC-E-VA-6.6	22	1SNA166936R1000	FIC-2/4-2	26	1SNA566000R0000	TC-E-RJ45-INF	14
1SNA166627R2200	TC-E-VA-2-2	34	1SNA166937R1100	FIT-2/4-2	51	1SNA566001R0000	FI-RJ45-DIA4	14
1SNA166628R0300	TC-E-C5A-2.2	34	1SNA166939R2300	FIP-2/4-2	51			
1SNA166630R0100	PC-E-VA-8.8	34	1SNA166941R2500	CC-I-VA-2	22			
1SNA166638R0500	COR-C-R1-6.6	24	1SNA166943R2700	FIDE-2/4-2	51			
1SNA166643R0200	COR-C-3	24	1SNA166945R2100	TO-I-VA-2	40			
1SNA166644R0300	FIT-2/1-2	51	1SNA166948R0400	TC-S-INF-VL-2.2	34			
1SNA166645R0400	CPP-2	55	1SNA166962R0000	KEM-3	23			
1SNA166646R0500	CPT-1	55	1SNA166963R0000	CC-TH35-VL-6.6	22			
1SNA166647R0600	CPP-1	55	1SNA166964R0000	TC-TH35-VL	34			
1SNA166672R0700	FIT-2/4-1	52	1SNA166972R0000	TT4-S-VL-INF	48			
1SNA166722R2100	CC-S-INF-VL-6.6	22	1SNA166976R0000	CC-E-VA-R2-6.6	22			
1SNA166723R2200	TO-S-INF-VL-12.12	40	1SNA166977R0000	TC-E-VA-R2-2.2	34			
1SNA166733R2400	CPT-4	55	1SNA166978R0000	COR-P-R1-8.8	50			
1SNA166734R2500	CPC-7 (1)	55	1SNA166979R0000	COR-C-R3	24			
1SNA166737R2000	CC-E-VA	22	1SNA166980R0000	BRE-T-4	54			
1SNA166738R0100	CC-D-VA	22	1SNA167002R0000	CPT-RJ45	14			
1SNA166741R0400	TO-DS-VL	40	1SNA167008R0300	EXBR1	26			
1SNA166742R0500	TC-DS-VL	34	1SNA167260R1700	BRE-C-2.5	26			
1SNA166743R0600	TO-E-VA	40	1SNA167264R0700	BRE-C-1	26			
1SNA166744R0700	TO-D-VA	40	1SNA167265R0000	BRE-C-1.5	26			
1SNA166745R0000	TF-E-VA	46	1SNA167378R1100	COP-FI-1	58			
1SNA166746R0100	TF-D-VA	46	1SNA167379R1200	COP-E-1	58			
1SNA166747R0200	TC-E-VA	34	1SNA167496R1100	PCVA	23			
1SNA166748R1300	TC-D-VA	34	1SNA167622R2600	IR1	26			
1SNA166757R0400	PO-DS-VL	40	1SNA167623R2700	IR2	26			
1SNA166758R1500	PC-DS-VL	34	1SNA167624R2000	IR3	26			

Type	Part Number	Page	Type	Part Number	Page	Type	Part Number	Page
BJ-VL	1SNA167680R0500	23	EXBR1	1SNA167008R0300	26	PF-D-VA	1SNA166762R0100	46
BRE-C-1	1SNA167264R0700	26	FC4-1	1SNA167927R1000	26	PF-E-VA	1SNA166761R0000	46
BRE-C-1.5	1SNA167265R0000	26	FC4-5	1SNA167931R1400	26	PO-DS-VL	1SNA166757R0400	40
BRE-C-2.5	1SNA167260R1700	26	FCB-1	1SNA167690R0700	26	PO-D-VA	1SNA166760R1300	40
BRE-C-4	1SNA205876R0400	26	FCB-2	1SNA167692R2500	26	PO-E-VA	1SNA166759R1600	40
BRE-C-6	1SNA168146R0200	26	FI-2/4-DIA4	1SNA167936R1100	49	PSC	1SNA173181R1300	26
BRE-T-0.34	1SNA168160R1400	54	FIC-2/1-1	1SNA166819R2300	26	TC-DS-VL	1SNA166742R0500	34
BRE-T-0.75	1SNA167779R1300	54	FIC-2/4-1	1SNA166525R1400	26	TC-D-VA	1SNA166748R1300	34
BRE-T-1	1SNA164921R1700	54	FIC-2/4-2	1SNA166936R1000	26	TC-E-C5A-2.2	1SNA166628R0300	34
BRE-T-1.5	1SNA164922R1000	54	FIC-2/4-DIA4	1SNA167937R0000	25	TC-E-RJ45-INF	1SNA566000R0000	14
BRE-T-2.5	1SNA164923R1100	54	FIC-2/4-I	1SNA166589R2500	26	TC-E-VA	1SNA166747R0200	34
BRE-T-4	1SNA166980R0000	54	FIC-2/4-R	1SNA166529R2000	26	TC-E-VA-2-2	1SNA166627R2200	34
BRE-T-6	1SNA168147R0300	54	FIDE-1/4-D	1SNA166897R1200	53	TC-E-VA-R2-2.2	1SNA166977R0000	34
CA	1SNA167697R2200	26	FIDE-1/4-G	1SNA166898R2300	52	TC-S-INF-VL-2.2	1SNA166948R0400	34
CC-D-VA	1SNA166738R0100	22	FIDE-2/4	1SNA166877R2500	52	TC-TH35-VL	1SNA166964R0000	34
CC-E-VA	1SNA166737R2000	22	FIDE-2/4-2	1SNA166943R2700	51	TF-DS-VL	1SNA166503R2700	46
CC-E-VA-6.6	1SNA166625R2000	22	FIM10-1	1SNA166516R1300	56	TF-D-VA	1SNA166746R0100	46
CC-E-VA-R2-6.6	1SNA166976R0000	22	FIM10-I-1	1SNA166574R2500	56	TF-E-VA	1SNA166745R0000	46
CC-I-VA-2	1SNA166941R2500	22	FIM10-R	1SNA166573R2400	56	TO-DS-VL	1SNA166741R0400	40
CC-R-VA	1SNA166523R1200	22	FIM20-I	1SNA166576R2700	56	TO-D-VA	1SNA166744R0700	40
CC-S-INF-VL-6.6	1SNA166722R2100	22	FIP-1/4-D	1SNA166555R2200	53	TO-E-VA	1SNA166743R0600	40
CC-TH35-VL-6.6	1SNA166963R0000	22	FIP-1/4-G	1SNA166556R2300	52	TO-E-VA-12.12	1SNA166925R1500	40
COP-E-1	1SNA167379R1200	58	FIP-2/4-1	1SNA166559R0600	52	TO-I-VA-2	1SNA166945R2100	40
COP-FI-1	1SNA167378R1100	58	FIP-2/4-2	1SNA166939R2300	51	TO-S-INF-VL-12.12	1SNA166723R2200	40
COR-C-3	1SNA166643R0200	24	FI-RJ45-DIA4	1SNA566001R0000	14	TT4-S-VL-INF	1SNA166972R0000	48
COR-C-R1-6.6	1SNA166638R0500	24	FIT-1/4-D	1SNA166546R2100	53			
COR-C-R2-6.6	1SNA166778R1100	24	FIT-1/4-G	1SNA166547R2200	52			
COR-C-R3	1SNA166979R0000	24	FIT-2/1-1	1SNA166821R1500	51			
COR-C-R4-6.6	1SNA167932R1500	24	FIT-2/1-2	1SNA166644R0300	51			
COR-C-R5-6.6	1SNA167934R1700	24	FIT-2/4-1	1SNA166550R0100	52			
COR-P-R1-8.8	1SNA166978R0000	50	FIT-2/4-2	1SNA166937R1100	51			
COR-T-4-4	1SNA167935R1000	50	FIT-2/4-I	1SNA166672R0700	52			
COR-T-R5-2.2	1SNA167933R1600	50	FX	1SNA167682R2300	23			
CPC-1	1SNA166578R0100	55	IR1	1SNA167622R2600	26			
CPC-7	1SNA166734R2500	55	IR2	1SNA167623R2700	26			
CPDE-1	1SNA166876R2400	55	IR3	1SNA167624R2000	26			
CPDE-2	1SNA166926R1600	55	KEM-1	1SNA166928R2000	23			
CPP-1	1SNA166647R0600	55	KEM-3	1SNA166962R0000	23			
CPP-2	1SNA166645R0400	55	M10-D-C5A	1SNA166513R1000	56			
CPT-1	1SNA166646R0500	55	M10-I-C5A-1	1SNA166774R0500	56			
CPT-2	1SNA166577R2000	55	M10-P-C5A	1SNA166772R0300	56			
CPT-4	1SNA166733R2400	55	M10-R-C5A	1SNA166566R2500	56			
CPT-5	1SNA166930R2600	55	M20-I-C5A	1SNA166777R0000	56			
CPT-RJ45	1SNA167002R0000	14	PC-DS-VL	1SNA166758R1500	34			
CVABM	1SNA183436R0500	23	PC-D-VA	1SNA166764R0300	34			
DEF-D-VA	1SNA166896R1100	46	PC-E-VA	1SNA166763R0200	34			
DEO-D-VA	1SNA166874R2200	40	PC-E-VA-8.8	1SNA166630R0100	34			
DEO-E-VA	1SNA166878R0600	40	PCVA	1SNA167496R1100	23			
DI	1SNA167981R1700	26	PCVL	1SNA167681R2200	23			
DLVR	1SNA167971R2400	26	PF-DS-VL	1SNA166506R2200	46			



RAILWAY APPLICATIONS

Terminal Blocks

ENTRELEC Terminal Blocks

As a leading supplier for railway applications, TE Connectivity proposes the most complete terminal block range of the market complying with all main international railway standards. The ENTRELEC range for railway applications is available in four technologies and covers all the needs for rolling stock and railroad infrastructures.

Railway applications

Terminal blocks

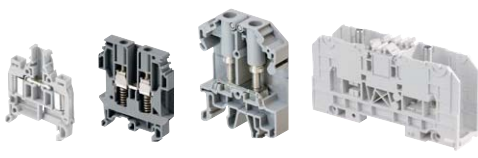
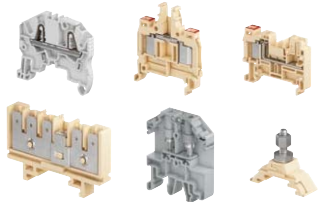

<u>Ranges, solutions and standards presentation</u>	2	1
<u>SNK series, PI-Spring technology</u>	11	2
<u>SNK series, Pluggable technology</u>	69	3
<u>ADO System® IDC and Pluggable technologies</u>	103	4
<u>Quick-connect technology</u>	137	5
<u>Stud technology</u>	169	6
<u>Screw clamp technology complying with NF F 55251 and CT448</u>	207	7
<u>SNK series, Screw clamp technology</u>	219	8
<u>Accessories</u>	309	9
<u>Index</u>	352	10

TE Connectivity proposes one of the largest Din Rail Terminal block offering on the market with various technologies: screw, PI-Spring, spring, IDC, pluggable, stud, etc. found in over 8000 products & solutions.

	SNK terminal blocks		Dedicated applications terminal blocks		Terminal blocks for railway applications
					
Scope	Qualified for worldwide applications and severe environments (such as hazardous locations, railways, marine and solar applications..). From 0.2 to 300 mm ² .		Specific terminal blocks and technologies for dedicated applications and markets.		The largest offering on the market for rolling stock and infrastructures.
Product families & functions	SNK PI-Spring technology 2.5 to 16 mm ² 12 to 4 AWG	Feed-through Multi-deck Ground Disconnect for fuses Component holder	ADO System® (IDC) 0.22 to 4 mm ² 24 to 12 AWG	ADO-ADO or ADO-screw clamp Feed-through / Multi-deck / Ground / Disconnect / for fuses / Component holder	SNK PI-Spring technology 2.5 to 16 mm ² 12 to 4 AWG
			Safety (spring loaded) 0.22 to 10 mm ² 24 to 6 AWG	Feed-through Disconnect Test & measurement	SNK pluggable screw & PI-Spring technologies 2.5 to 4 mm ² 12 to 10 AWG
	SNK screw clamp technology 4 to 240 mm ² 12 to 500 Kcmil	Feed-through Multi-deck Ground Disconnect for fuses Test & measurement Marshalling Component holder	Stud 25 to 300 mm ² 4 AWG to 1000 Kcmil	One stud 2 studs One stud - One screw clamp	ADO System® (IDC) 1.5 to 4 mm ² 16 to 12 AWG
			Ring lug 6 to 16 mm ² 8 to 6 AWG	Feed-through Test & measurement	Stud 4 to 185 mm ²
	SNK pluggable screw & PI-Spring technologies 2.5 to 4 mm ² 12 to 10 AWG	Feed-through Multi-deck Ground	Miniblocks 1.5 to 6 mm ² 18 to 8 AWG	Screw clamp Spring ADO System® (IDC)	Quick-connect 2.5 to 6 mm ²
			Other types Test & measurement: with sliding link, blade, plug Pluggable: feed-through, double deck, disconnect Sensors/actuators: screw, spring, ADO system (IDC) Installation: screw, spring Protection: ground + neutral Component holders: screw, spring, ADO system (IDC)		

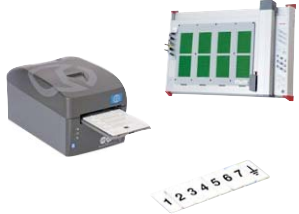

www.te.com

DBL power distribution blocks	ESSAILEC® test blocks	Interfast PLC pre-wiring system	Marking solutions
			
<p>The preferred choice for primary power distribution and solar applications.</p>	<p>Test blocks for safe and easy testing on secondary circuits of current and voltage transformers and sensors.</p>	<p>PLC pre-wiring system for fast, flexible, reliable connection of PLC's in process automation applications.</p>	<p>Markers & marking systems for all identification requirements in electrical panels.</p>
<p>From 80 A up to 550 A (IEC)</p> <p>Modular blocks: single pole, three & four poles, up to 12 outputs</p> <p>Terminal blocks types: 2 to 10 poles, up to 20 outputs</p>	<p>Current and voltage sockets & plugs</p> <p>Simultaneous testing of 1 to 4 independent circuits on the same socket</p> <p>Several testing principle such as "make before break" for safe current transformer testing</p> <p>Panel and switchboard mounting : base, flush, rack, TH35 rail</p> <p>Multicircuits sockets & plugs</p>	<p>Interfast PCB: Compact & standard modules</p> <p>Interfast MS: Modular system based on terminal block technology</p> <p>Functions:</p> <ul style="list-style-type: none"> - 1 to 4 wire connections (sensors) - Disconnect - Fuse - Signal indication - Relays - Optocouplers - Solenoid valve control - Galvanic isolation (2.5 kV). 	<p>Terminal block identification and group markers</p> <p>Wire and cable identification</p> <p>Component and equipment identification</p> <p>Panel identification</p> <p>Pre-printed markers for terminal blocks</p>

ENTRELEC terminal blocks for railway applications

A recognized expertise

TE Connectivity, a worldwide leading supplier for rolling stock and infrastructure

Compliance with main international railway standards

All technologies: PI-Spring, pluggable, ADO System® (IDC), stud and quick-connect

Customized terminal block assemblies: from design to manufacturing and packing

Easy Rail Designer 3D: ease the design of terminal blocks assemblies

Terminal blocks in infrastructure

– Electrical distribution and control panels.



PI-Spring



Screw



Pluggable



Screw
NF F 55251
and CT448

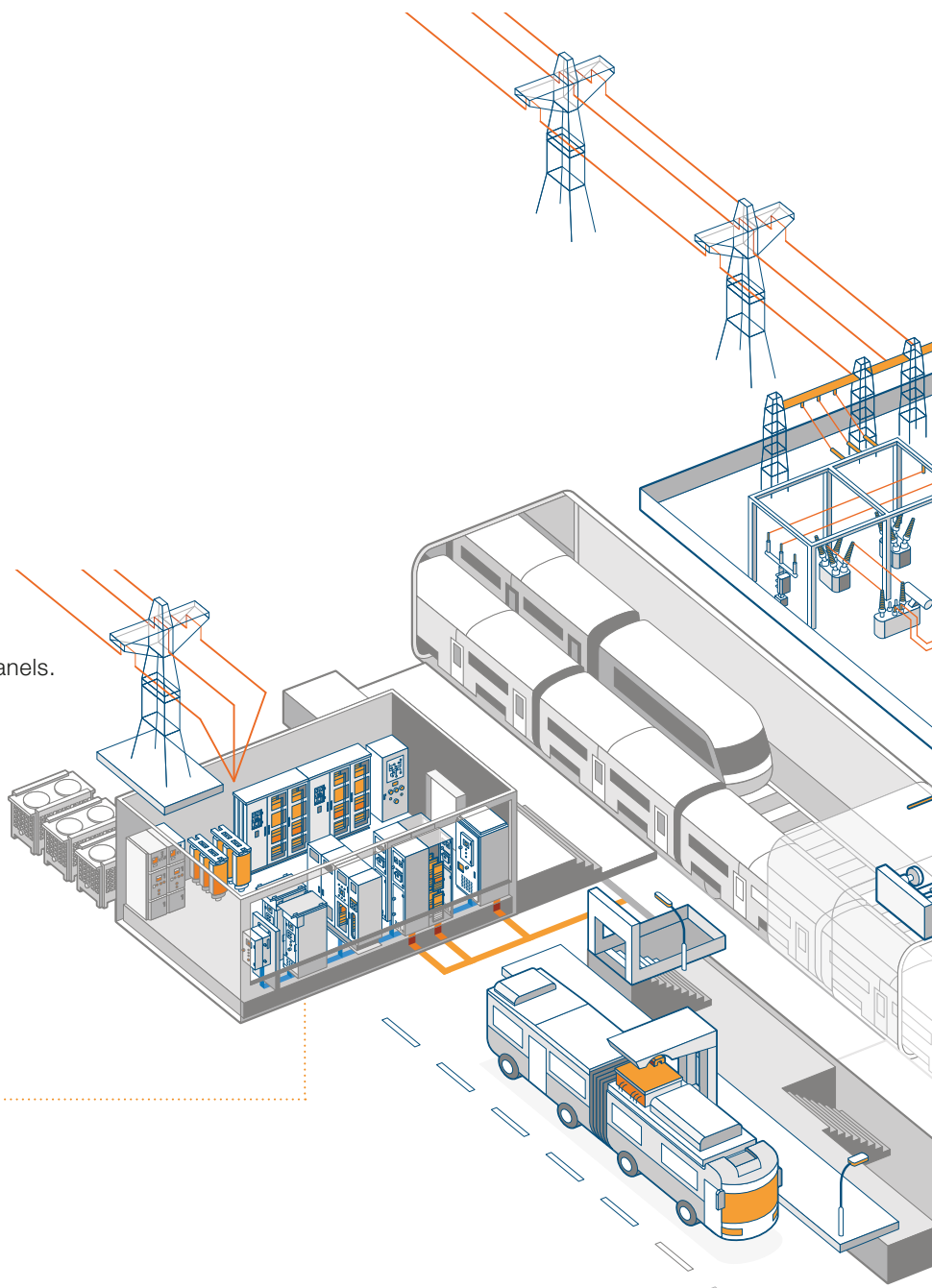
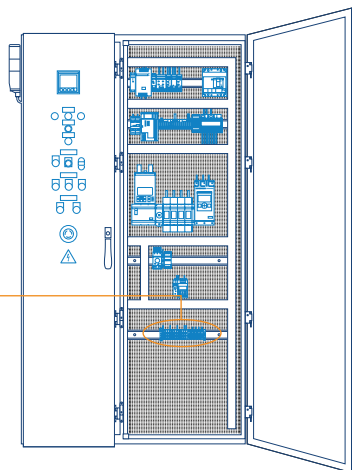

Terminal blocks in rolling stock

- HVAC
- Door control
- Electrical distribution
- Control system and Pilot center.



PI-Spring



Quick-connect



Pluggable



Stud



ADO System[®] IDC



Ring lug

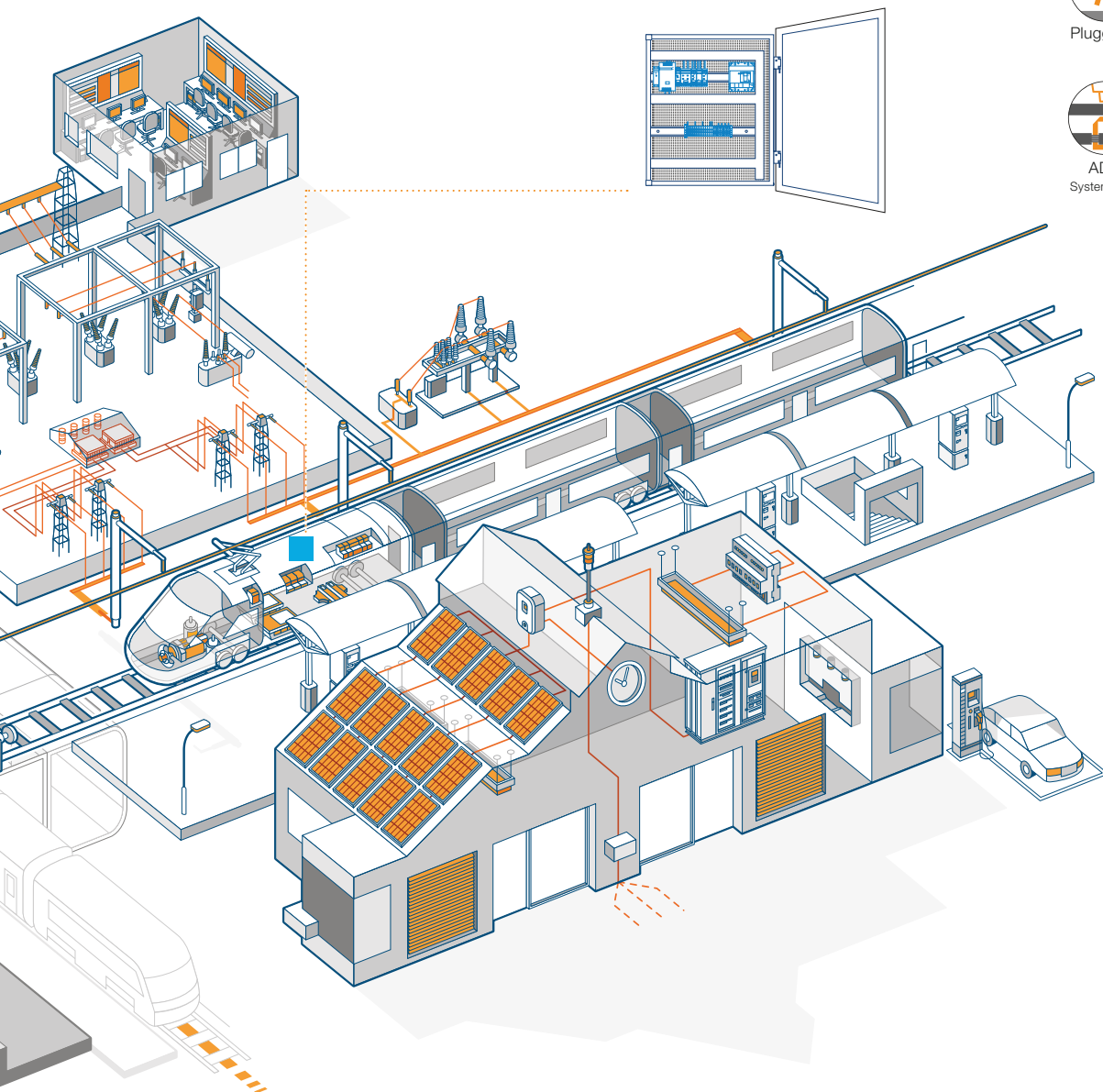

ENTRELEC terminal blocks for railway applications

Overview of ranges

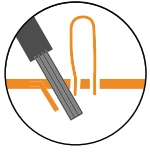

SNK series, PI-Spring and pluggable technologies

The benefits of 2 technologies in 1 connection

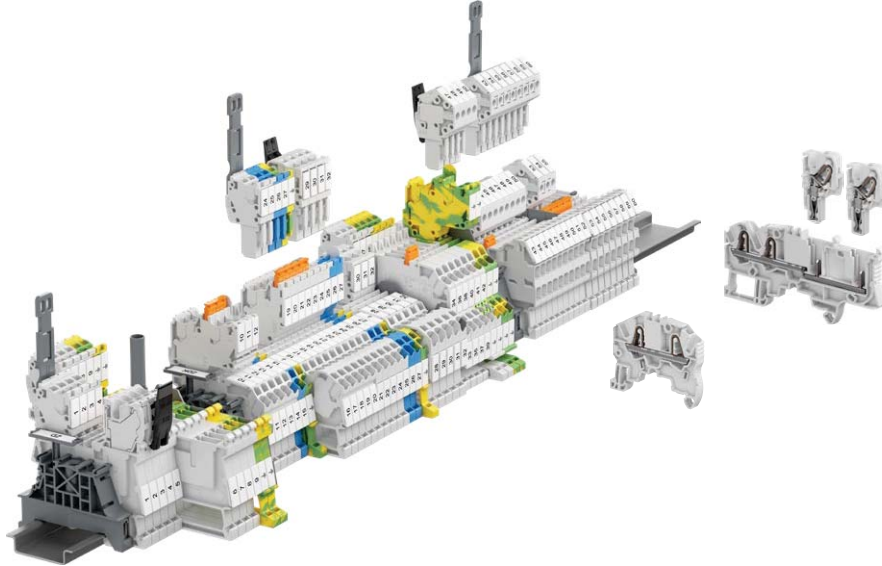

ADO System® IDC and pluggable technologies

The fastest connection technology for rolling stock

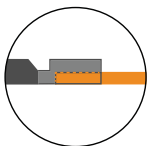
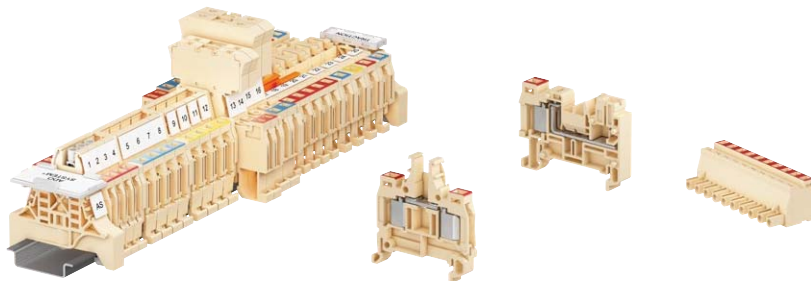

Quick-connect technology

The historical technology for railway control and signal distribution

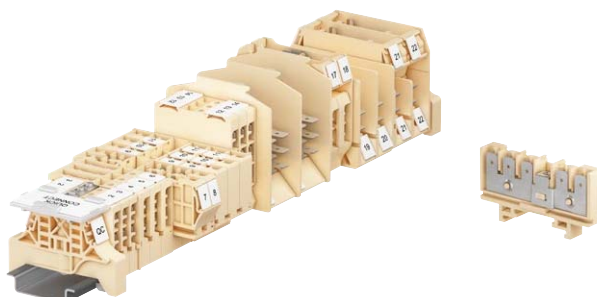

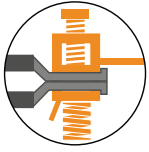

Stud technology

The "Pull-out proof" connection for rolling stock

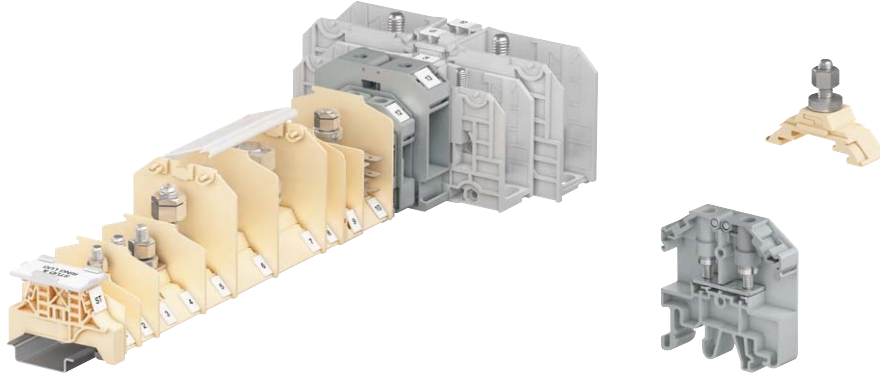

Screw clamp technology complying with NF F 55251 and CT448

The proven reliability and performance for railway infrastructure



SNK series, Screw clamp technology

A smart design to support your daily connection challenges



Rail vehicles are subjected to extreme environmental conditions (high vibration and shock), corrosion (underground applications or tunnels).

All ENTRELEC terminal blocks listed in this catalog are tested in accordance with the latest and most demanding standards applying to rolling stock applications.



IEC 61373 railway applications – Rolling stock equipment – Shock and vibration tests
TE Connectivity terminal blocks are complying with **category 1 (body mounted) class B**.

EN 45545-2 railway applications. Fire protection on railway vehicles. Requirements for fire behavior of materials and components

TE Connectivity terminal blocks plastic materials are rated **HL3 R22 (the highest Hazard level)**. They can be used on vehicles for subway, tube, sleeping and couchette.

NF F 16-101 Directive relative to selecting materials in relation to their fire resistance in terms of its behavior in a fire, the opacity of smoke and the toxicity of the gas released.

NF F 16-102 Complement to NF F 16-101. The purpose of this standard is to specify the application of NF F 16-101 to electrical equipment and especially to individual apparatus.

TE Connectivity terminal blocks plastic materials are rated **I2F2. Level 3**. This level concern products mounted inside a room for passengers or running crew.

UL94 (North America) standard for safety of Flammability of Plastic Materials for parts in devices and Appliances testing

TE Connectivity terminal blocks plastic materials are rated **UL94 V0**.

NFPA 130 (North America) standard for Fixed Guideway Transit and Passenger rail systems

TE Connectivity terminal blocks plastic materials complies with **NFPA130 per ASTM E 162** and **ASTM E 662** standards tests. It also complies with **FRA238.103** and **BSS 7239** standards.

UNI CEI 11170-3 (Italy) Fire Test to Railway Components

TE Connectivity terminal blocks have their plastic materials in accordance with the FS Italian standard UNI EN 11170-3 according to the test conditions of ISO 11925-2 (flame 30s) and NF F 16-101 (F2 index).

Railway solutions and tools

Easy Rail Designer 3D, Terminal block assembly software

Engineering, do it yourself easily

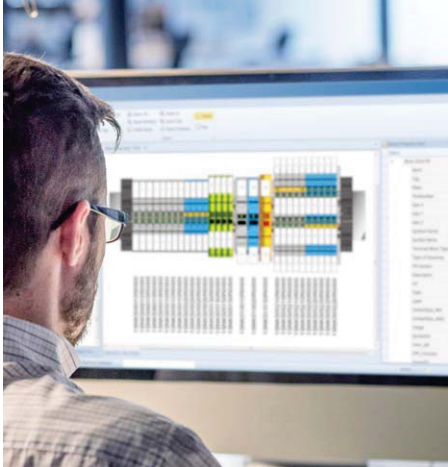

Advanced 3D drawing and data export

- Built-in 3D viewer
- Integration to CAD/CAE softwares
- Compatibility with TE Connectivity printers
- Detailed drawings of the rail, assembly and markers.

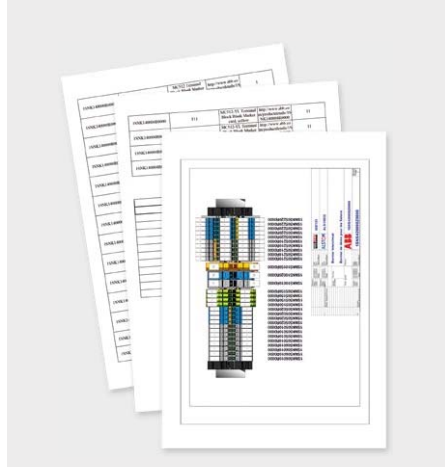

Customized project management

- Management of multiple projects
- Indication on the drawing of the supplier's, integrator's and end user's data
- Drawing update indexing with PDF report.

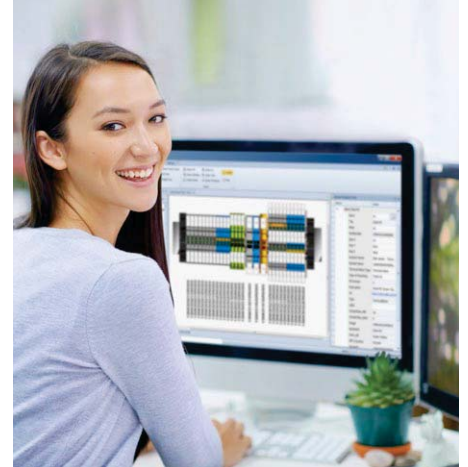

User-friendly configurator

- Intuitive Windows® (1) user interface
- Autocorrecting system
- Powerful search engine
- Insertion of products external to the database.

(1) Windows® is a registered trademark of Microsoft.

Assembling, rely on TE Connectivity expertise

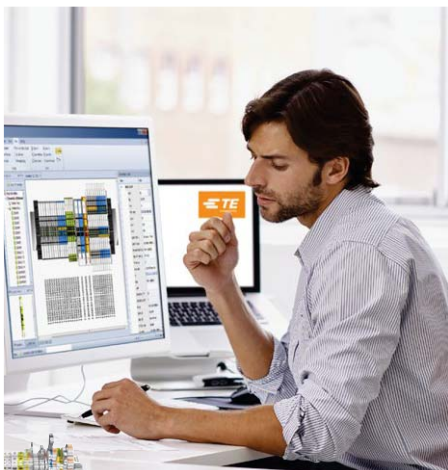

TE Connectivity technical expertise

- Drawing technical verification done by TE Connectivity experts
- 100% reliable data import to TE Connectivity production system.



Flexible production

- 3 types of assembly:
 - rail mounted
 - pre-assembled
 - packed in kit.
- Possibility to add some other TE Connectivity Din rail products.



Optimized inventory

- Products and markers stocked by TE Connectivity
- Marking managed by TE Connectivity
- One single product part number corresponds to one complete assembly.

15NC16710150201

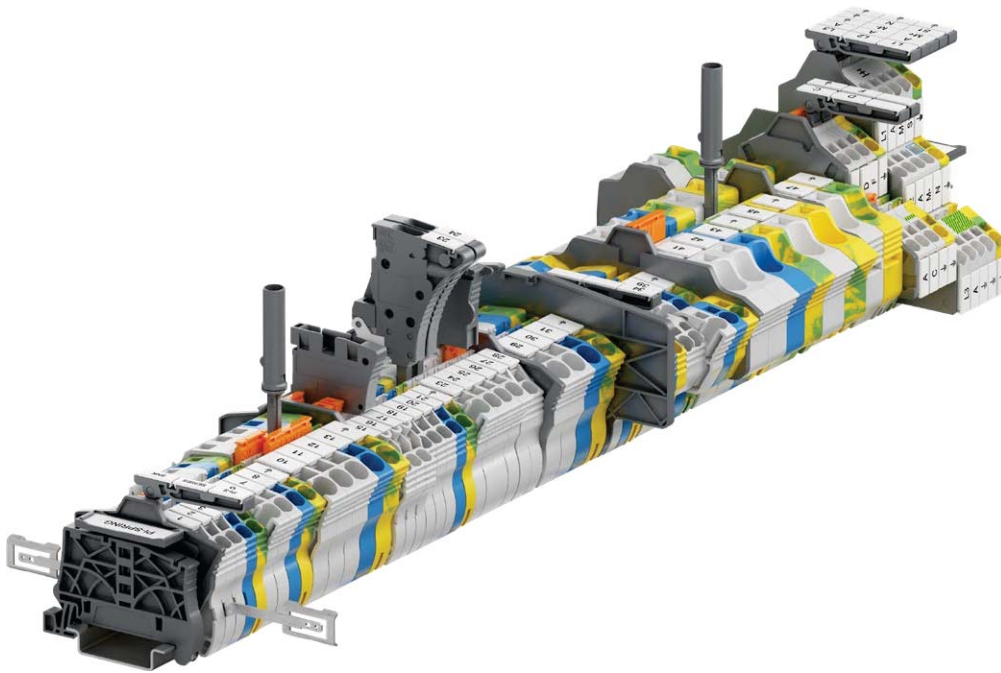

Railway applications, terminal blocks

PI-Spring technology

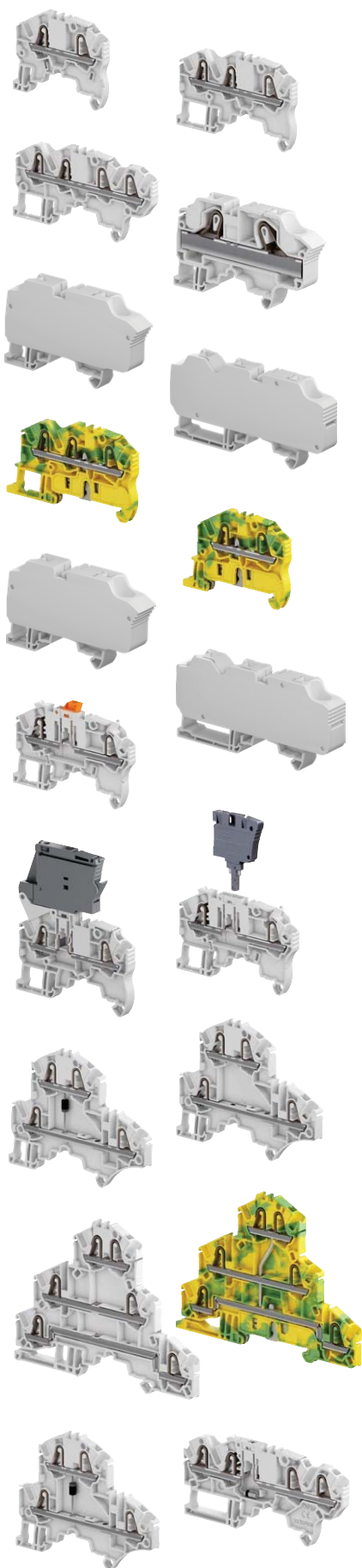

Technologies presentation		12
Overview		18
Feed-through		
2.5 mm ² / 12 AWG	ZK2.5	19
	ZK2.5-3P	with 3 connections 20
	ZK2.5-4P	with 4 connections 21
4 mm ² / 10 AWG	ZK4	22
	ZK4-3P	with 3 connections 23
	ZK4-4P	with 4 connections 24
6 mm ² / 8 AWG	ZK6	25
	ZK6-3P	with 3 connections 26
10 mm ² / 6 AWG	ZK10	27
	ZK10-PV	28
	ZK10-3P	with 3 connections 29
	ZK10-3P-PV	with 3 connections 30
16 mm ² / 4 AWG	ZK16	31
	ZK16-PV	32
	ZK16-3P	with 3 connections 33
	ZK16-3P-PV	with 3 connections 34
Ground		
2.5 mm ² / 12 AWG	ZK2.5-PE	35
	ZK2.5-PE-3P	with 3 connections 36
	ZP2.5-PE-4P	with 4 connections 37
4 mm ² / 10 AWG	ZK4-PE	38
	ZK4-PE-3P	with 3 connections 39
	ZK4-PE-4P	with 4 connections 40
6 mm ² / 8 AWG	ZK6-PE	41
	ZK6-PE-3P	with 3 connections 42
10 mm ² / 6 AWG	ZK10-PE	43
	ZK10-PE-3P	with 3 connections 44
16 mm ² / 4 AWG	ZK16-PE	45
	ZK16-PE-3P	with 3 connections 46
Disconnect with blade		
2.5 mm ² / 12 AWG	ZK2.5-S	with test sockets 47
	ZK2.5-S-4P	with test sockets 48
	ZK2.5-S-R1	49
Disconnect with plug		
2.5 mm ² / 12 AWG	ZK2.5-SP	with test sockets 50
	ZK2.5-SP-4P	with test sockets 51
For 5x20 fuses		
2.5 mm ² / 12 AWG	ZK2.5-SF	52
	ZK2.5-SF-R	with blown fuse indicator 53
Double deck		
2.5 mm ² / 12 AWG	ZK2.5-D2	2 feed-through circuits 54
	ZK2.5-D1	1 feed-through circuit 55
	ZK2.5-D2-PE	1 feed-through circuit and 1 ground circuit 56
	ZK2.5-D1-PE	1 ground circuit 57
Triple deck		
2.5 mm ² / 12 AWG	ZK2.5-T3	3 feed-through circuits 58
	ZK2.5-T1	1 feed-through circuit 59
	ZK2.5-L-L-PE	60
	ZK2.5-L-N-PE	2 feed-through circuits and 1 ground circuit 61
	ZK2.5-T1-PE	1 ground circuit 62
Component holder		
2.5 mm ² / 12 AWG	ZK2.5-CH-4P-LR	63
	ZK2.5-CH-4P-RL	64
	ZK2.5-D-CH-UD	65
	ZK2.5-D-CH-DU	66
	ZK2.5-D-CH2-DU-RL	67

PI-Spring technology - SNK series, terminal blocks

Features and benefits

The patented PI-Spring technology provides the benefits of both Push-In and Spring technologies in one connection



Speed up your projects

50% faster connection time with Push-in mode

Our Push-in connection technology allows:
A direct one step insertion with rigid and prepared flexible conductors.
Easy and quick insertion of the prepared flexible conductor or rigid conductor.

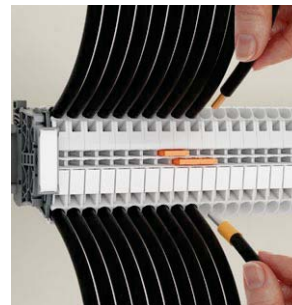

Push-in mode



Spring mode

Reduced effort and conductor preparation time with spring mode

- Our connection requires minimal effort to insert wires with the screwdriver
- Flexible conductors preparation is not necessary.
- The screwdriver locks onto terminal freeing up hands.

Better project identification

- Circuit identification is improved thanks to the 20% larger marking area
- Pre-mark by hand or with label on our flat marking surface and start immediately the wiring, before the final markers mounting
- Spare markers re-printing in case of modifications.



Clear circuit identification

1SNK162074S0201

PI-Spring technology - SNK series, terminal blocks

Features and benefits

Easy to install

Smart design facilitating assembly process

Mounting, wiring, testing... made easy

Avoid mounting and wiring errors: asymmetrical design allows immediate visual check in case of reversed terminal blocks.



Asymmetrical design avoids mounting error

Faster accessories mounting

Save up to 70% mounting time thanks to :

- screwless jumpers, component plugs, test devices, end stops and snap-in ground terminal blocks.



Screwless accessories

Snap-in ground terminal blocks

Closed jumper location allows great stiffness of the terminal block, avoid deflection while tightening and optimal jumper guiding.

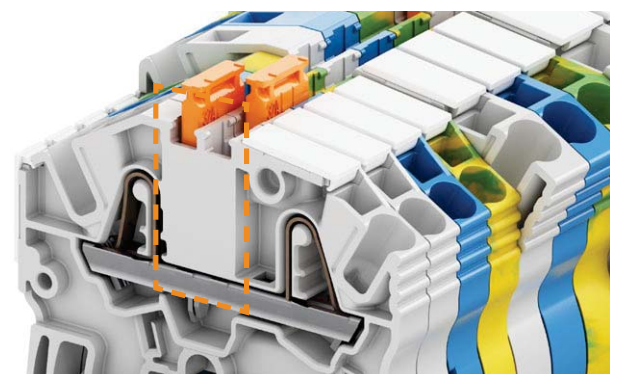

Closed jumper location for stiffness.

1SNK16207450201

PI-Spring technology - SNK series, terminal blocks

Features and benefits

Easy to install

Smart accessories

Flexible test solutions from individual insulated test adapter to test connectors for complete assemblies testing.

- Direct plug-in into jumpers channels
- 5, 6, 8 mm spacing, mixing various spacing is possible
- 1000 V rating.



Plug-in individual test adapter.

Plug-in test connector.

Component holder plugs for series or parallel component mounting (resistors, filters, diodes..).

Can be installed after wiring.

Series plug offers screwless component connection (no soldering).

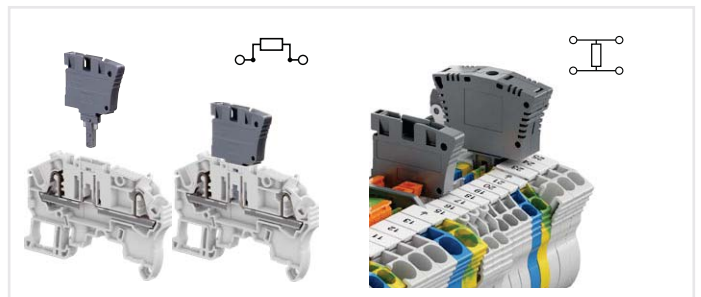

Series plug associated with disconnect blocks.

Parallel plug to be installed between 2 blocks.

Smart plug-in jumpers:

Pre-cut poles removable by hand: clean cut.

Insulated up to 1000 V (avoid use of separators).

Predefined shapes in molding to easily identify connected poles with a pen.

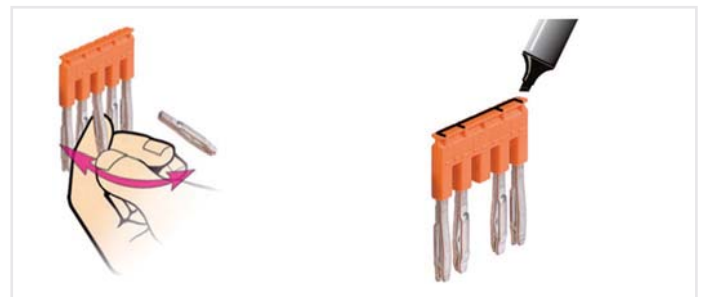

Pre-cut poles easy removable by hand.

Predefined shape to identify connected poles.

PI-Spring technology - SNK series, terminal blocks

Features and benefits

Optimized logistics

Reduce your accessories inventory by up to 50%

SNK PI-Spring, screw and pluggable ranges share the same accessories.

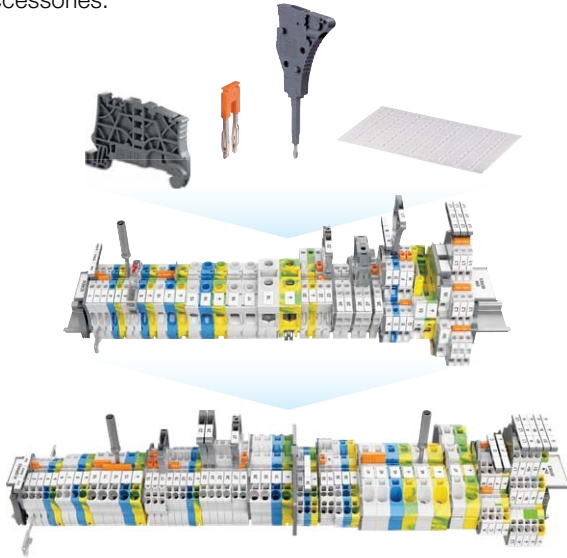

Shared accessories for SNK PI-Spring, screw and pluggable ranges

- All end sections and circuit separators fit several types and sizes of blocks
- One end section fits up to 21 models
- One circuit separator fits with 62 terminal blocks.



End sections and circuit separators fit several types and sizes of blocks

50% less inventory makes PI-Spring attractive to all worldwide markets

- The user selects one range but benefit from 2 connection modes (push-in and spring) which have global certifications and access to markets and applications worldwide
- Reduced packaging adapted to the usage (20 items packaging on some items).

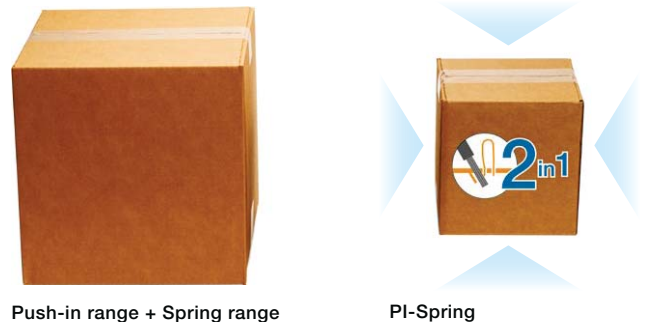

Push-in range + Spring range

PI-Spring

Facilitate maintenance operations

Terminal blocks can be individually removed from a terminal assembly equipped with markers: TE Connectivity markers become independent after strip mounting. The markers remain on terminal in any situation.

Markers are interchangeable: the smaller marker can fit any bigger block.

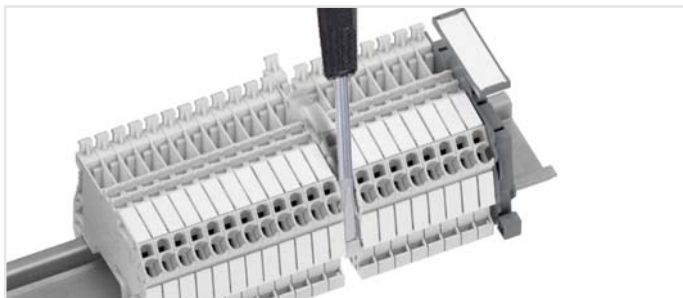

Maintenance operations facilitated

Reliable in harsh conditions

Qualified for worldwide markets, applications and for severe environments: vibration, shock, corrosion...

High corrosion resistance

PI-Spring clamp is made of high quality stainless steel. Salt mist withstand up to 1,000 hours (as per IEC 60068).



SNK series, terminal blocks

PI-Spring technology - Range overview from 2.5 to 16 mm² - 12 to 4 AWG

2 Connections

Single deck

Feed-through
Ground
Disconnect
Fuse
Solar : 1500 VDC

NEW

3 Connections

Single deck

Feed-through
Ground
Solar: 1500 VDC

NEW

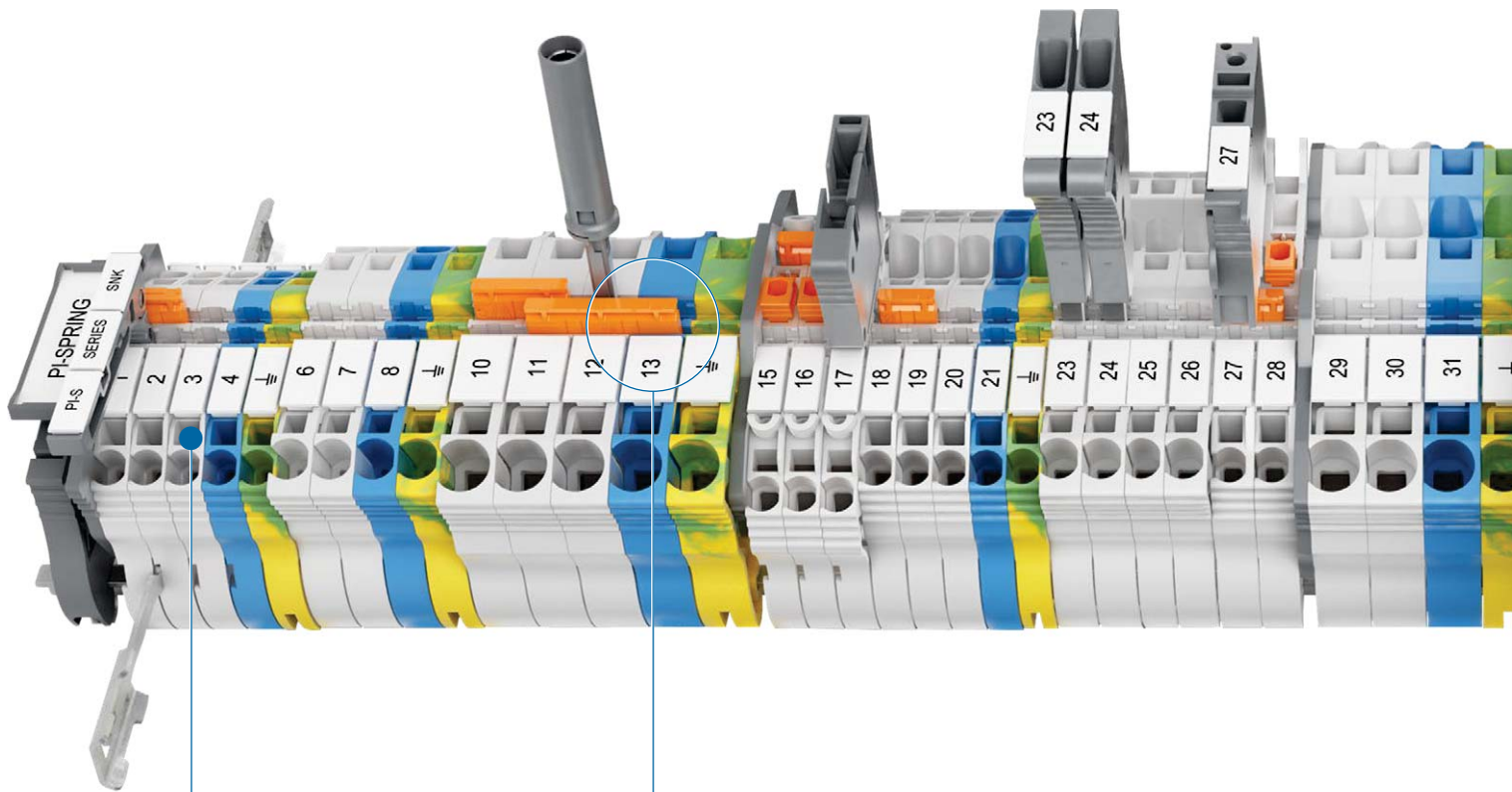

Voltage test

screwdriver entry
point accepts
Category II probes

Double central channels

allows multiconfigurations
(jumping, testing and measuring)

4

Connections

Single deck

Feed-through
Ground
Disconnect
Component holder

2x2

Connections

Double deck

Feed-through
Ground
Component holder

3x2

Connections

Triple deck

Feed-through
Ground

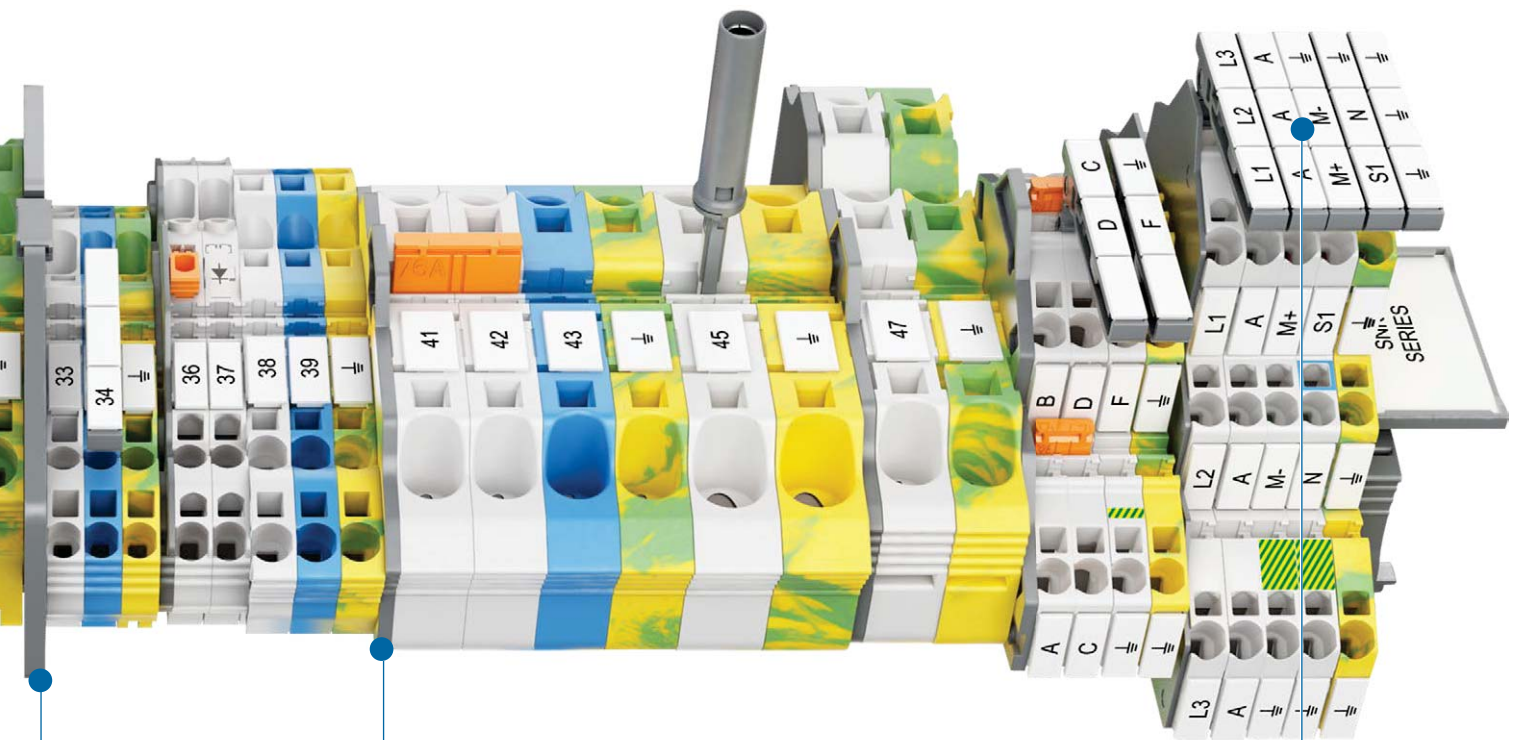

Two circuit separators
for the entire range

End section
can be used
as circuit separator

Rotating label holder
easy plug-in in
jumper channel

SNK series, terminal blocks

PI-Spring technology

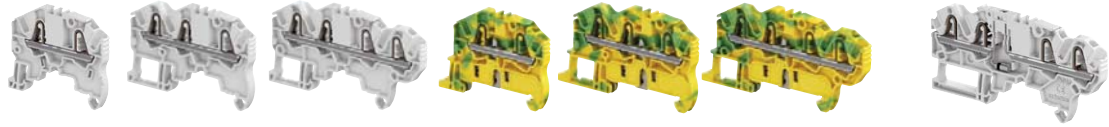

		Feed-through			Ground			Component holder	
Section									
2.5 mm ²	12 AWG	ZK2.5	ZK2.5-3P	ZK2.5-4P	ZK2.5-PE	ZK2.5-PE-3P	ZK2.5-PE 4P	ZK2.5-CH-4P-LR	ZK2.5-CH-4P-RL
4 mm ²	10 AWG	ZK4	ZK4-3P	ZK4-4P	ZK4-PE	ZK4-PE-3P	ZK4-PE- 4P		
6 mm ²	8 AWG	ZK6	ZK6-3P		ZK6-PE	ZK6-PE-3P			
10 mm ²	6 AWG	ZK10	ZK10-3P		ZK10-PE	ZK10-PE-3P			
16 mm ²	4 AWG	ZK10-PV New	ZK10-3P-PV						
		ZK16	ZK16-3P	ZK16-PE	ZK16-PE-3P				
		ZK16-PV New	ZK16-3P-PV						

		Feed-through		Ground		Component holder		
Section								
2.5 mm ²	12 AWG	ZK2.5-D2	ZK2.5-D1	ZK2.5-D2-PE	ZK2.5-D1-PE	ZK2.5-D-CH-UD	ZK2.5-D-CH-DU	ZK2.5-D-CH2-DU-RL

		Feed-through		Ground	
Section					
2.5 mm ²	12 AWG	ZK2.5-T3	ZK2.5-T1	ZK2.5-L-L-PE	ZK2.5-T1-PE
				ZK2.5-L-N-PE	

		With blade		With plug		For 5x20 mm fuses		Aligned with ZK2.5-SF
Section								
2.5 mm ²	12 AWG	ZK2.5-S	ZK2.5-S-4P	ZK2.5-SP	ZK2.5-SP-4P	ZK2.5-SF	ZK2.5-SF-R1	ZK2.5-S-R1
							ZK2.5-SF-R3	

Clamp -
 Channels for jumpering or testing -
 Test socket -
 Blown-fuse indicator

1SNK162020S0201 - Rev. B

ZK2.5 PI-Spring terminal blocks

Feed-through - 5.2 mm 0.205 in spacing

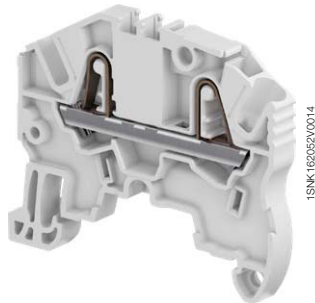

ZK2.5

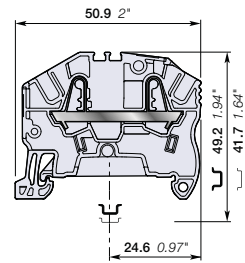

5.2 mm 0.205 in spacing

Description

Combine high performance with compact dimensions:

- 1000 V AC / DC IEC 600 V UL,
- Opt for the best marking visibility thanks to the up-front, flat marker zone, which lets you mark up to eight digits or increase the font size.

Ordering details

Description	Color	Type	Part Number	Pkg qty	Weight (1 pce) g
Feed-through 2 connections	Grey	ZK2.5	1SNK705010R0000	50	5.50
	Blue	ZK2.5-BL	1SNK705020R0000	50	5.50
	Orange	ZK2.5-OR	1SNK705030R0000	50	5.50
	Yellow	ZK2.5-YL	1SNK705060R0000	50	5.50
	Green	ZK2.5-GN	1SNK705061R0000	50	5.50
	Red	ZK2.5-RD	1SNK705062R0000	50	5.50
	White	ZK2.5-WH	1SNK705065R0000	50	5.50
	Black	ZK2.5-BK	1SNK705066R0000	50	5.50

Main technical data

Connecting capacity	IEC	UL - CSA	Rail	TH 35-7.5, TH 35-15
1 conductor per clamp	Rigid: Solid/Stranded	0.2 ... 4 mm²	26 ... 12 AWG	
	Flexible without ferrule	0.22 ... 2.5 mm²		Wire stripping length
	Flexible with non insulated ferrule	0.22 ... 2.5 mm²	26 ... 14 AWG	11 mm
	Flexible with insulated ferrule	0.22 ... 2.5 mm²	26 ... 14 AWG	0.433 in
2 conductors per clamp	Flexible with twin ferrule	0.22 ... 0.5 mm²	26 ... 20 AWG	Tool (for flexible conductor without ferrule)
Rated current / Rated cross section		24 A / 2.5 mm²	20 A / 12 AWG	
Rated short-time withstand current (1s)		300 A	396 A	
Short Circuit Current Rating (with specific conditions)			100 kA	
Rated voltage		1000 V	600 V	
Impulse withstand voltage		8000 V		
Protection		IP20	NEMA 1	
Increased safety Ex e		693 V 21 A IEC/EN 60079-7 - IM2 II 2 GD Ex eb I/II/III/C		

The connecting capacity data for one Rigid: Solid/Stranded, or one Flexible conductor (when applicable) is a mandatory information required by IEC, UL and CSA standards (Copper conductors). All other data are provided as supplementary information only. For more details, please consult our CB, UL or CSA certificates and technical datasheet available on <http://www.TE.com>



Mounting instructions

Wire stripping length	11 mm
Tool (for flexible conductor without ferrule)	Flat screwdriver Ø 3.5 mm Ø 0.138 in

Accessories

Description	Color	Type	Part Number	Pkg qty	Weight (1 pce) g	
1 End stops	Dark grey	BAZ1	1SNK900002R0000	50	5.30	
2 End sections	Dark grey	EK2.5	1SNK705910R0000	20	1.80	
3 Jumper bars	Orange	2 poles	JB5-2	1SNK905302R0000	50	1.30
		3 poles	JB5-3	1SNK905303R0000	50	2.00
		4 poles	JB5-4	1SNK905304R0000	50	2.70
		5 poles	JB5-5	1SNK905305R0000	50	3.50
		10 poles	JB5-10	1SNK905310R0000	30	7.10
		50 poles	JB5-50	1SNK905350R0000	10	36.00
4 Cross spacing jumpers	Orange	JB85-3	1SNK900603R0000	10	2.80	
5 Circuit separators	Dark grey	CS-R2	1SNK900106R0000	20	3.80	
6 Test adapters	Dark grey	For test plugs DIA 2 mm 0.079 in	TP2	1SNK900203R0000	20	1.70
		For test plugs DIA 4 mm 0.157 in	TP4	1SNK900205R0000	20	2.40
7 Test connectors	Dark grey	5.2 mm 0.205 in spacing	TC5	1SNK900200R0000	10	5.20
		End module, 5.2 mm 0.205 in	TC5-R1	1SNK900201R0000	10	5.20
8 Shield connectors		SHBP	1SNK900601R0000	20	4.10	
9 Terminal block markers	White	Blank marker	MG-CPM 13 41790	1SNB041790R0512	1960	0.23
		Blank card	MC512	1SNK140000R0000	22	9.00
			MC512PA	1SNK149999R0000	20	10.00
		Universal wire markers holder	Grey	UMH	1SNK900611R0000	10

Complete list of accessories is indicated in the terminal block datasheet including end stops.

Some accessories such as jumper bars may modify the terminal block's ratings: Complete information available in the accessories section of the catalog.

Ground PI-Spring terminal blocks

Description	Color	Type	Part Number	Pkg qty	Weight (1 pce) g
Ground	Green-yellow	ZK2.5-PE	1SNK705150R0000	20	10.00

Technical data valid for copper conductors only.

ZK2.5-3P PI-Spring terminal blocks

Feed-through with 3 connections - 5.2 mm 0.205 in spacing



ZK2.5-3P

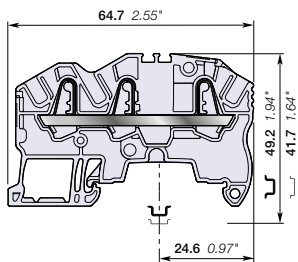

5.2 mm 0.205 in spacing

Description

Find all the features of the ZK2.5 terminal block with the added option of distributing or branching 3 conductors.

Ordering details

Description	Color	Type	Part Number	Pkg qty	Weight (1 pce) g
Feed-through 3 connections	Grey	ZK2.5-3P	1SNK705011R0000	50	7.40
	Blue	ZK2.5-3P-BL	1SNK705021R0000	50	7.40
	Orange	ZK2.5-3P-OR	1SNK705031R0000	50	7.40
	Yellow	ZK2.5-3P-YL	1SNK705067R0000	50	7.40
	Green	ZK2.5-3P-GN	1SNK705068R0000	50	7.40
	Red	ZK2.5-3P-RD	1SNK705069R0000	50	7.40
	White	ZK2.5-3P-WH	1SNK705072R0000	50	7.40
	Black	ZK2.5-3P-BK	1SNK705073R0000	50	7.40

Main technical data

Connecting capacity	IEC	UL - CSA	Rail	Wire stripping length	TH 35-7.5, TH 35-15
1 conductor per clamp	Rigid: Solid/Stranded	0.2 ... 4 mm ²	26 ... 12 AWG	11 mm	0.433 in
	Flexible without ferrule	0.22 ... 2.5 mm ²			
	Flexible with non insulated ferrule	0.22 ... 2.5 mm ²	26 ... 14 AWG		
	Flexible with insulated ferrule	0.22 ... 2.5 mm ²	26 ... 14 AWG		
2 conductors per clamp	Flexible with twin ferrule	0.22 ... 0.5 mm ²	26 ... 20 AWG	Tool (for flexible conductor without ferrule)	Flat screwdriver Ø 3.5 mm Ø 0.138 in
Rated current / Rated cross section		24 A / 2.5 mm ²	20 A / 12 AWG		
Rated short-time withstand current (1s)		300 A	396 A		
Short Circuit Current Rating (with specific conditions)			100 kA		
Rated voltage		1000 V	600 V		
Impulse withstand voltage		8000 V			
Protection		IP20	NEMA 1		
Increased safety Ex e		693 V 21 A IEC/EN 60079-7 - IM2 II 2 GD Ex eb IIC/IIC			

The connecting capacity data for one Rigid: Solid/Stranded, or one Flexible conductor (when applicable) is a mandatory information required by IEC, UL and CSA standards (Copper conductors). All other data are provided as supplementary information only. For more details, please consult our CB, UL or CSA certificates and technical datasheet available on <http://www.TE.com>



Accessories

Description	Color	Type	Part Number	Pkg qty	Weight (1 pce) g	
1 End stops	Dark grey	BAZ1	1SNK900002R0000	50	5.30	
2 End sections	Dark grey	EK2.5-3P	1SNK705911R0000	20	2.40	
3 Jumper bars	Orange	2 poles	JB5-2	1SNK905302R0000	50	1.30
		3 poles	JB5-3	1SNK905303R0000	50	2.00
		4 poles	JB5-4	1SNK905304R0000	50	2.70
		5 poles	JB5-5	1SNK905305R0000	50	3.50
		10 poles	JB5-10	1SNK905310R0000	30	7.10
4 Cross spacing jumpers	Orange	JB85-3	1SNK900603R0000	10	2.80	
5 Circuit separators	Dark grey	CS-R3	1SNK900107R0000	20	6.40	
6 Test adapters	Dark grey	For test plugs DIA 2 mm 0.079 in	TP2	1SNK900203R0000	20	1.70
		For test plugs DIA 4 mm 0.157 in	TP4	1SNK900205R0000	20	2.40
7 Test connectors	Dark grey	5.2 mm 0.205 in spacing	TC5	1SNK900200R0000	10	5.20
		End module, 5.2 mm 0.205 in	TC5-R1	1SNK900201R0000	10	5.20
		Blank marker	White	MG-CPM 13 41790	1SNB041790R0512	1960
8 Terminal block markers	White	Blank card	MC512	1SNK140000R0000	22	9.00
		Universal wire markers holder	Grey	UMH	1SNK900611R0000	10

Complete list of accessories is indicated in the terminal block datasheet including end stops. Some accessories such as jumper bars may modify the terminal block's ratings: Complete information available in the accessories section of the catalog.

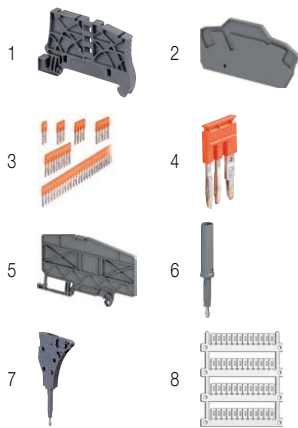

Ground PI-Spring terminal blocks

Description	Color	Type	Part Number	Pkg qty	Weight (1 pce) g
Ground	Green-yellow	ZK2.5-PE-3P	1SNK705151R0000	20	11.90

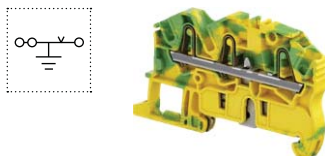

Technical data valid for copper conductors only.

ZK2.5-4P PI-Spring terminal blocks

Feed-through with 4 connections - 5.2 mm 0.205 in spacing



ZK2.5-4P

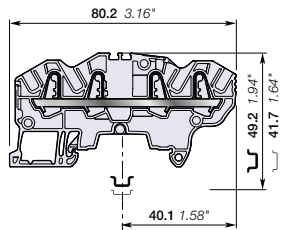

5.2 mm 0.205 in spacing

Description

Find all the features of the ZK2.5 terminal block with the added option of distributing or branching 4 conductors.

Ordering details

Description	Color	Type	Part Number	Pkg qty	Weight (1 pce) g
Feed-through 4 connections	Grey	ZK2.5-4P	1SNK705012R0000	50	9.00
	Blue	ZK2.5-4P-BL	1SNK705022R0000	50	9.00
	Orange	ZK2.5-4P-OR	1SNK705032R0000	50	9.00
	Yellow	ZK2.5-4P-YL	1SNK705074R0000	50	9.00
	Green	ZK2.5-4P-GN	1SNK705075R0000	50	9.00
	Red	ZK2.5-4P-RD	1SNK705076R0000	50	9.00
	White	ZK2.5-4P-WH	1SNK705079R0000	50	9.00
	Black	ZK2.5-4P-BK	1SNK705080R0000	50	9.00

Main technical data

Connecting capacity		IEC	UL - CSA	Mounting instructions	
1 conductor per clamp	Rigid: Solid/Stranded	0.2 ... 4 mm²	26 ... 12 AWG	Rail	TH 35-7.5, TH 35-15
	Flexible without ferrule	0.22 ... 2.5 mm²		Wire stripping length	11 mm 0.433 in
	Flexible with non insulated ferrule	0.22 ... 2.5 mm²	26 ... 14 AWG	Tool (for flexible conductor without ferrule)	Flat screwdriver Ø 3.5 mm Ø 0.138 in
	Flexible with insulated ferrule	0.22 ... 2.5 mm²	26 ... 14 AWG		
2 conductors per clamp	Flexible with twin ferrule	0.22 ... 0.5 mm²	26 ... 20 AWG		
Rated current / Rated cross section		24 A / 2.5 mm²	20 A / 12 AWG		
Rated short-time withstand current (1s)		300 A	396 A		
Short Circuit Current Rating (with specific conditions)			100 kA		
Rated voltage		1000 V	600 V		
Impulse withstand voltage		8000 V			
Protection		IP20	NEMA 1		
Increased safety Ex e		693 V 21 A IEC/EN 60079-7 - IM2 II 2 GD Ex eb I/IC/IIIC			

The connecting capacity data for one Rigid: Solid/Stranded, or one Flexible conductor (when applicable) is a mandatory information required by IEC, UL and CSA standards (Copper conductors). All other data are provided as supplementary information only. For more details, please consult our CB, UL or CSA certificates and technical datasheet available on <http://www.TE.com>

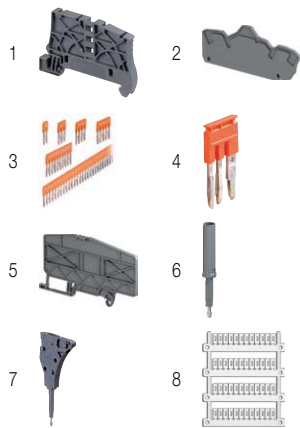

Accessories

Description	Color	Type	Part Number	Pkg qty	Weight (1 pce) g	
1 End stops	Dark grey	BAZ1	1SNK900002R0000	50	5.30	
2 End sections	Dark grey	EK2.5-4P	1SNK705912R0000	20	2.70	
3 Jumper bars	Orange	2 poles	JB5-2	1SNK905302R0000	50	1.30
		3 poles	JB5-3	1SNK905303R0000	50	2.00
		4 poles	JB5-4	1SNK905304R0000	50	2.70
		5 poles	JB5-5	1SNK905305R0000	50	3.50
		10 poles	JB5-10	1SNK905310R0000	30	7.10
		50 poles	JB5-50	1SNK905350R0000	10	36.00
4 Cross spacing jumpers	Orange	JB85-3	1SNK900603R0000	10	2.80	
5 Circuit separators	Dark grey	CS-R3	1SNK900107R0000	20	6.40	
6 Test adapters	Dark grey	For test plugs DIA 2 mm 0.079 in	TP2	1SNK900203R0000	20	1.70
		For test plugs DIA 4 mm 0.157 in	TP4	1SNK900205R0000	20	2.40
7 Test connectors	Dark grey	5.2 mm 0.205 in spacing	TC5	1SNK900200R0000	10	5.20
		End module, 5.2 mm 0.205 in	TC5-R1	1SNK900201R0000	10	5.20
8 Terminal block markers	White	Blank marker	MG-CPM 13 41790	1SNB041790R0512	1960	0.23
		Blank card	MC512	1SNK140000R0000	22	9.00
			MC512PA	1SNK149999R0000	20	10.00
	Universal wire markers holder	Grey	UMH	1SNK900611R0000	10	0.20

Complete list of accessories is indicated in the terminal block datasheet including end stops. Some accessories such as jumper bars may modify the terminal block's ratings: Complete information available in the accessories section of the catalog.



Ground PI-Spring terminal blocks

Description	Color	Type	Part Number	Pkg qty	Weight (1 pce) g
Ground	Green-yellow	ZK2.5-PE-4P	1SNK705152R0000	20	13.60

Technical data valid for copper conductors only.

ZK4 PI-Spring terminal blocks

Feed-through - 6 mm 0.236 in spacing



ZK4

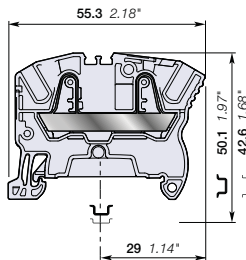

6 mm 0.236 in spacing

Description

Combine high performance with compact dimensions:

- 1000 V AC / DC IEC 600 V UL,
- Opt for the best marking visibility thanks to the up-front, flat marker zone, which lets you mark up to eight digits or increase the font size.

Ordering details

Description	Color	Type	Part Number	Pkg qty	Weight (1 pce) g
Feed-through 2 connections	Grey	ZK4	1SNK706010R0000	50	7.90
	Blue	ZK4-BL	1SNK706020R0000	50	7.90
	Orange	ZK4-OR	1SNK706030R0000	50	7.90
	Yellow	ZK4-YL	1SNK706060R0000	50	7.90
	Red	ZK4-RD	1SNK706062R0000	50	7.90
	Black	ZK4-BK	1SNK706066R0000	50	7.90

Main technical data

Connecting capacity		IEC	UL - CSA	Mounting instructions	
1 conductor per clamp	Rigid: Solid/Stranded	0.5 ... 6 mm ²	26 ... 10 AWG	Rail	 TH 35-7.5, TH 35-15
	Flexible without ferrule	0.5 ... 4 mm ²			
	Flexible with non insulated ferrule	0.5 ... 4 mm ²	26 ... 12 AWG	Tool (for flexible conductor without ferrule)	 Flat screwdriver Ø 3.5 mm Ø 0.138 in
	Flexible with insulated ferrule	0.5 ... 4 mm ²	26 ... 12 AWG		
2 conductors per clamp	Flexible with twin ferrule	0.5 ... 1 mm ²	26 ... 18 AWG		
Rated current / Rated cross section		32 A / 4 mm ²	30 A / 10 AWG		
Rated short-time withstand current (1s)		480 A	636 A		
Short Circuit Current Rating (with specific conditions)			100 kA		
Rated voltage		1000 V	600 V		
Impulse withstand voltage		8000 V			
Protection		IP20	NEMA 1		
Increased safety Ex e		693 V 29 A IEC/EN 60079-7 - IM2 II 2 GD Ex eb IIC/IIC			

The connecting capacity data for one Rigid: Solid/Stranded, or one Flexible conductor (when applicable) is a mandatory information required by IEC, UL and CSA standards (Copper conductors). All other data are provided as supplementary information only. For more details, please consult our CB, UL or CSA certificates and technical datasheet available on <http://www.TE.com>



Accessories

Description	Color	Type	Part Number	Pkg qty	Weight (1 pce) g	
1 End stops	Dark grey	BAZ1	1SNK900002R0000	50	5.30	
2 End sections	Dark grey	EK2.5	1SNK705910R0000	20	1.80	
3 Jumper bars	Orange	2 poles	JB6-2	1SNK906302R0000	50	1.30
		3 poles	JB6-3	1SNK906303R0000	50	2.10
		4 poles	JB6-4	1SNK906304R0000	50	2.90
		5 poles	JB6-5	1SNK906305R0000	50	3.60
		10 poles	JB6-10	1SNK906310R0000	20	7.40
4 Cross spacing jumpers	Orange	JB85-3	1SNK900603R0000	10	2.80	
5 Circuit separators	Dark grey	CS-R2	1SNK900106R0000	20	3.80	
6 Test adapters	Dark grey	For test plugs DIA 2 mm 0.079 in	TP2	1SNK900203R0000	20	1.70
		For test plugs DIA 4 mm 0.157 in	TP4	1SNK900205R0000	20	2.40
7 Test connectors	Dark grey	TC5-R1	1SNK900201R0000	10	5.20	
8 Spacers	Dark grey	ES-TC6	1SNK900105R0000	10	0.80	
9 Terminal block markers	White	Blank marker	MG-CPM 13 41791	1SNB041791R0612	1680	0.27
		Blank card	MC612	1SNK150000R0000	22	10.00
		Universal wire markers holder	Grey	UMH	1SNK900611R0000	10

Complete list of accessories is indicated in the terminal block datasheet including end stops. Some accessories such as jumper bars may modify the terminal block's ratings: Complete information available in the accessories section of the catalog.

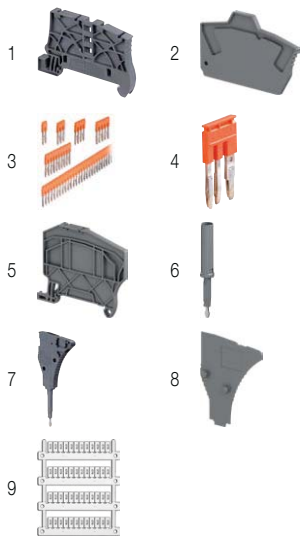

Ground PI-Spring terminal blocks

Description	Color	Type	Part Number	Pkg qty	Weight (1 pce) g
Ground Profile aligned with ZK4	Green-yellow	ZK4-PE	1SNK706150R0000	20	12.60

Technical data valid for copper conductors only.

ZK4-3P PI-Spring terminal blocks

Feed-through with 3 connections - 6 mm 0.236 in spacing

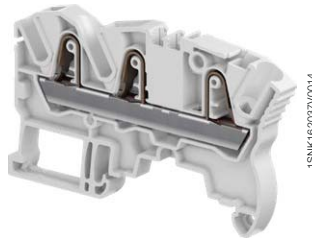

ZK4-3P

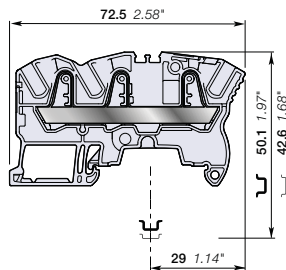

6 mm 0.236 in spacing

Description

Find all the features of the ZK4 terminal block with the added option of distributing or branching 3 conductors.

Ordering details

Description	Color	Type	Part Number	Pkg qty	Weight (1 pce) g
Feed-through 3 connections	Grey	ZK4-3P	1SNK706011R0000	50	11.00
	Blue	ZK4-3P-BL	1SNK706021R0000	50	11.00
	Orange	ZK4-3P-OR	1SNK706031R0000	50	11.00

Main technical data

Connecting capacity	IEC	UL - CSA	Mounting instructions
1 conductor per clamp	Rigid: Solid/Stranded Flexible without ferrule Flexible with non insulated ferrule Flexible with insulated ferrule	0.5 ... 6 mm² 0.5 ... 4 mm² 0.5 ... 4 mm² 0.5 ... 4 mm²	26 ... 10 AWG 26 ... 12 AWG 26 ... 12 AWG
2 conductors per clamp	Flexible with twin ferrule	0.5 ... 1 mm²	26 ... 18 AWG
Rated current / Rated cross section	32 A / 4 mm²	30 A / 10 AWG	
Rated short-time withstand current (1s)	480 A	636 A	
Short Circuit Current Rating (with specific conditions)		100 kA	
Rated voltage	1000 V	600 V	
Impulse withstand voltage	8000 V		
Protection	IP20	NEMA 1	
Increased safety Ex e	693 V 29 A IEC/EN 60079-7 - IM2 II 2 GD Ex eb I/IIc/IIIC		

The connecting capacity data for one Rigid: Solid/Stranded, or one Flexible conductor (when applicable) is a mandatory information required by IEC, UL and CSA standards (Copper conductors). All other data are provided as supplementary information only. For more details, please consult our CB, UL or CSA certificates and technical datasheet available on <http://www.TE.com>



Accessories

Description	Color	Type	Part Number	Pkg qty	Weight (1 pce) g	
1 End stops	Dark grey	BAZ1	1SNK900002R0000	50	5.30	
2 End sections	Dark grey	EK2.5-3P	1SNK705911R0000	20	2.40	
3 Jumper bars	Orange	2 poles	JB6-2	1SNK906302R0000	50	1.30
		3 poles	JB6-3	1SNK906303R0000	50	2.10
		4 poles	JB6-4	1SNK906304R0000	50	2.90
		5 poles	JB6-5	1SNK906305R0000	50	3.60
		10 poles	JB6-10	1SNK906310R0000	20	7.40
		50 poles	JB6-50	1SNK906350R0000	10	38.10
4 Cross spacing jumpers	Orange	JB85-3	1SNK900603R0000	10	2.80	
5 Circuit separators	Dark grey	CS-R3	1SNK900107R0000	20	6.40	
6 Test adapters	Dark grey	For test plugs DIA 2 mm 0.079 in	TP2	1SNK900203R0000	20	1.70
		For test plugs DIA 4 mm 0.157 in	TP4	1SNK900205R0000	20	2.40
7 Test connectors	Dark grey	TC5-R1	1SNK900201R0000	10	5.20	
8 Spacers	Dark grey	ES-TC6	1SNK900105R0000	10	0.80	
9 Terminal block markers	White	Blank marker	MG-CPM 13 41791	1SNB041791R0612	1680	0.27
		Blank card	MC612	1SNK150000R0000	22	10.00
		Universal wire markers holder	MC612PA	1SNK159999R0000	20	11.00
	Grey	UMH	1SNK900611R0000	10	0.20	

Complete list of accessories is indicated in the terminal block datasheet including end stops. Some accessories such as jumper bars may modify the terminal block's ratings: Complete information available in the accessories section of the catalog.

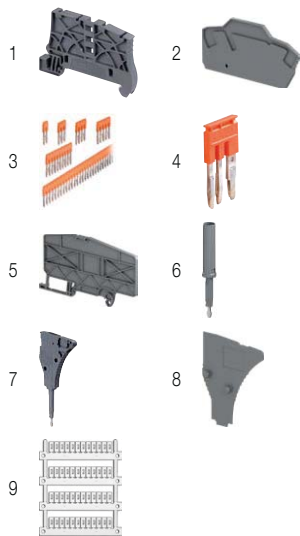

Ground PI-Spring terminal blocks

Description	Color	Type	Part Number	Pkg qty	Weight (1 pce) g
Ground	Green-yellow	ZK4-PE-3P	1SNK706151R0000	20	15.70

Technical data valid for copper conductors only.



ZK4-4P PI-Spring terminal blocks

Feed-through with 4 connections - 6 mm 0.236 in spacing

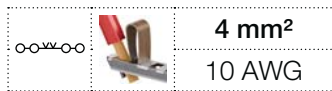

ZK4-4P

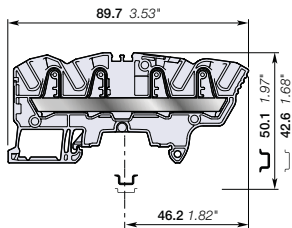

6 mm 0.236 in spacing

Description

Find all the features of the ZK4 terminal block with the added option of distributing or branching 4 conductors.

Ordering details

Description	Color	Type	Part Number	Pkg qty	Weight (1 pce) g
Feed-through 4 connections	Grey	ZK4-4P	1SNK706012R0000	50	13.80
	Blue	ZK4-4P-BL	1SNK706022R0000	50	13.80
	Orange	ZK4-4P-OR	1SNK706032R0000	50	13.80

Main technical data

Connecting capacity		IEC	UL - CSA	Mounting instructions	
1 conductor per clamp	Rigid: Solid/Stranded	0.5 ... 6 mm ²	26 ... 10 AWG	Rail	TH 35-7.5, TH 35-15
	Flexible without ferrule	0.5 ... 4 mm ²		Wire stripping length	12.5 mm 0.492 in
	Flexible with non insulated ferrule	0.5 ... 4 mm ²	26 ... 12 AWG		
	Flexible with insulated ferrule	0.5 ... 4 mm ²	26 ... 12 AWG		
2 conductors per clamp	Flexible with twin ferrule	0.5 ... 1 mm ²	26 ... 18 AWG	Tool (for flexible conductor without ferrule)	Flat screwdriver Ø 3.5 mm Ø 0.138 in
Rated current / Rated cross section		32 A / 4 mm ²	30 A / 10 AWG		
Rated short-time withstand current (1s)		480 A	636 A		
Short Circuit Current Rating (with specific conditions)			100 kA		
Rated voltage		1000 V	600 V		
Impulse withstand voltage		8000 V			
Protection		IP20	NEMA 1		
Increased safety Ex e		693 V 29 A IEC/EN 60079-7 - IM2 II 2 GD Ex eb I/IC/IIIC			

The connecting capacity data for one Rigid: Solid/Stranded, or one Flexible conductor (when applicable) is a mandatory information required by IEC, UL and CSA standards (Copper conductors). All other data are provided as supplementary information only. For more details, please consult our CB, UL or CSA certificates and technical datasheet available on <http://www.TE.com>



Accessories

Description	Color	Type	Part Number	Pkg qty	Weight (1 pce) g	
1 End stops	Dark grey	BAZ1	1SNK900002R0000	50	5.30	
2 End sections	Dark grey	EK2.5-4P	1SNK705912R0000	20	2.70	
3 Jumper bars	Orange	2 poles	JB6-2	1SNK906302R0000	50	1.30
		3 poles	JB6-3	1SNK906303R0000	50	2.10
		4 poles	JB6-4	1SNK906304R0000	50	2.90
		5 poles	JB6-5	1SNK906305R0000	50	3.60
		10 poles	JB6-10	1SNK906310R0000	20	7.40
		50 poles	JB6-50	1SNK906350R0000	10	38.10
4 Cross spacing jumpers	Orange	JB85-3	1SNK900603R0000	10	2.80	
5 Circuit separators	Dark grey	CS-R3	1SNK900107R0000	20	6.40	
6 Test adapters	Dark grey	For test plugs DIA 2 mm 0.079 in	TP2	1SNK900203R0000	20	1.70
		For test plugs DIA 4 mm 0.157 in	TP4	1SNK900205R0000	20	2.40
7 Test connectors	Dark grey	TC5-R1	1SNK900201R0000	10	5.20	
8 Spacers	Dark grey	ES-TC6	1SNK900105R0000	10	0.80	
9 Terminal block markers	White	MG-CPM 13 41791	1SNB041791R0612	1680	0.27	
		MC612	1SNK150000R0000	22	10.00	
		MC612PA	1SNK159999R0000	20	11.00	
	Grey	UMH	1SNK900611R0000	10	0.20	

Complete list of accessories is indicated in the terminal block datasheet including end stops. Some accessories such as jumper bars may modify the terminal block's ratings: Complete information available in the accessories section of the catalog.

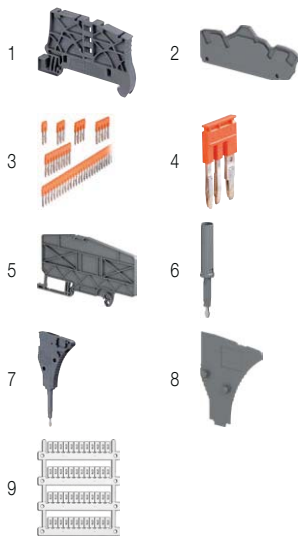

Ground PI-Spring terminal blocks

Description	Color	Type	Part Number	Pkg qty	Weight (1 pce) g
Ground Profile aligned with ZK4-4P	Green-yellow	ZK4-PE-4P	1SNK706152R0000	20	18.40

Technical data valid for copper conductors only.

ZK6 PI-Spring terminal blocks

Feed-through - 8 mm 0.315 in spacing

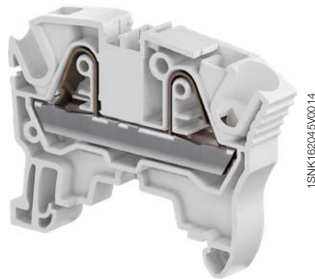

ZK6

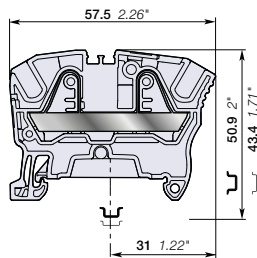

8 mm 0.315 in spacing

Description

Combine high performance with compact dimensions:

- 1000 V AC / DC IEC 600 V UL,
- Opt for the best marking visibility thanks to the up-front, flat marker zone, which lets you mark up to eight digits or increase the font size.

Ordering details

Description	Color	Type	Part Number	Pkg qty	Weight (1 pce) g
Feed-through 2 connections	Grey	ZK6	1SNK708010R0000	50	11.80
	Blue	ZK6-BL	1SNK708020R0000	50	11.80
	Orange	ZK6-OR	1SNK708030R0000	50	11.80
	Yellow	ZK6-YL	1SNK708060R0000	50	11.80
	Red	ZK6-RD	1SNK708062R0000	50	11.80
	Black	ZK6-BK	1SNK708066R0000	50	11.80

Main technical data

Connecting capacity	IEC	UL - CSA	Mounting instructions		
1 conductor per clamp	Rigid: Solid/Stranded	0.5 ... 10 mm ²	24 ... 8 AWG	Rail 	TH 35-7.5, TH 35-15
	Flexible without ferrule	0.5 ... 6 mm ²			
	Flexible with non insulated ferrule	0.5 ... 6 mm ²	24 ... 10 AWG	Tool (for flexible conductor without ferrule) 	Flat screwdriver Ø 3.5 mm Ø 0.138 in
	Flexible with insulated ferrule	0.5 ... 6 mm ²	24 ... 10 AWG		
2 conductors per clamp	Flexible with twin ferrule	0.5 ... 1.5 mm ²	24 ... 16 AWG		
Rated current / Rated cross section		41 A / 6 mm ²	50 A / 8 AWG		
Rated short-time withstand current (1s)		720 A	1008 A		
Short Circuit Current Rating (with specific conditions)			100 kA		
Rated voltage		1000 V	600 V		
Impulse withstand voltage		8000 V			
Protection		IP20	NEMA 1		
Increased safety Ex e		693 V 37 A IEC/EN 60079-7 - IM2 II 2 GD Ex eb I/II/III C			

The connecting capacity data for one Rigid: Solid/Stranded, or one Flexible conductor (when applicable) is a mandatory information required by IEC, UL and CSA standards (Copper conductors). All other data are provided as supplementary information only. For more details, please consult our CB, UL or CSA certificates and technical datasheet available on <http://www.TE.com>



Accessories

Description	Color	Type	Part Number	Pkg qty	Weight (1 pce) g	
1 End stops	Dark grey	BAZ1	1SNK900002R0000	50	5.30	
2 End sections	Dark grey	EK2.5	1SNK705910R0000	20	1.80	
3 Jumper bars	Orange	2 poles	JB8-2	1SNK908302R0000	50	2.70
		3 poles	JB8-3	1SNK908303R0000	50	4.10
		4 poles	JB8-4	1SNK908304R0000	50	5.60
		5 poles	JB8-5	1SNK908305R0000	40	7.00
		10 poles	JB8-10	1SNK908310R0000	20	14.20
4 Cross spacing jumpers	Orange	JB85-3	1SNK900603R0000	10	2.80	
5 Circuit separators	Dark grey	CS-R2	1SNK900106R0000	20	3.80	
6 Test adapters	Dark grey	For test plugs DIA 2 mm 0.079 in	TP2	1SNK900203R0000	20	1.70
		For test plugs DIA 4 mm 0.157 in	TP4	1SNK900205R0000	20	2.40
7 Test connectors	Dark grey	TC5-R1	1SNK900201R0000	10	5.20	
8 Spacers	Dark grey	ES-TC8	1SNK900104R0000	10	1.40	
		MG-CPM 13 41791	1SNB041791R0612	1680	0.27	
		MC812	1SNK160000R0000	22	10.00	
9 Terminal block markers	White	Blank marker	MC812PA	1SNK169999R0000	20	14.00
		Blank card	UMH	1SNK900611R0000	10	0.20

Complete list of accessories is indicated in the terminal block datasheet including end stops. Some accessories such as jumper bars may modify the terminal block's ratings. Complete information available in the accessories section of the catalog.

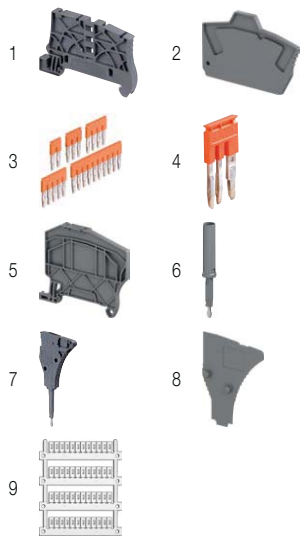

Ground PI-Spring terminal blocks

Description	Color	Type	Part Number	Pkg qty	Weight (1 pce) g
Ground	Green-yellow	ZK6-PE	1SNK708150R0000	20	20.30

Technical data valid for copper conductors only.



ZK6-3P PI-Spring terminal blocks

Feed-through with 3 connections - 8 mm 0.315 in spacing

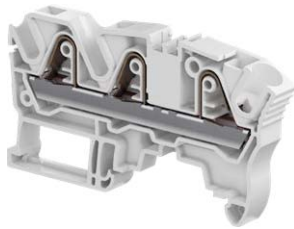

ZK6-3P

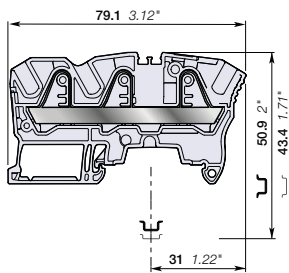

8 mm 0.315 in spacing

Description

Find all the features of the ZK6 terminal block with the added option of distributing or branching 3 conductors.

Ordering details

Description	Color	Type	Part Number	Pkg qty	Weight (1 pce) g
Feed-through 3 connections	Grey	ZK6-3P	1SNK708011R0000	50	16.70
	Blue	ZK6-3P-BL	1SNK708021R0000	50	16.70
	Orange	ZK6-3P-OR	1SNK708031R0000	50	16.70

Main technical data

Connecting capacity		IEC	UL - CSA	Mounting instructions	
1 conductor per clamp	Rigid: Solid/Stranded	0.5 ... 10 mm²	24 ... 8 AWG	Rail	TH 35-7.5, TH 35-15
	Flexible without ferrule	0.5 ... 6 mm²		Wire stripping length	12.5 mm 0.492 in
	Flexible with non insulated ferrule	0.5 ... 6 mm²	24 ... 10 AWG		
	Flexible with insulated ferrule	0.5 ... 6 mm²	24 ... 10 AWG		
2 conductors per clamp	Flexible with twin ferrule	0.5 ... 1.5 mm²	24 ... 16 AWG	Tool (for flexible conductor without ferrule)	Flat screwdriver Ø 3.5 mm Ø 0.138 in
Rated current / Rated cross section		41 A / 6 mm²	50 A / 8 AWG		
Rated short-time withstand current (1s)		720 A	1008 A		
Short Circuit Current Rating (with specific conditions)			100 kA		
Rated voltage		1000 V	600 V		
Impulse withstand voltage		8000 V			
Protection		IP20	NEMA 1		
Increased safety Ex e		693 V 37 A IEC/EN 60079-7 - IM2 II 2 GD Ex eb I/IC/IIIC			

The connecting capacity data for one Rigid: Solid/Stranded, or one Flexible conductor (when applicable) is a mandatory information required by IEC, UL and CSA standards (Copper conductors). All other data are provided as supplementary information only. For more details, please consult our CB, UL or CSA certificates and technical datasheet available on <http://www.TE.com>



Accessories

Description	Color	Type	Part Number	Pkg qty	Weight (1 pce) g	
1 End stops	Dark grey	BAZ1	1SNK900002R0000	50	5.30	
2 End sections	Dark grey	EK6-3P	1SNK708911R0000	20	2.80	
3 Jumper bars	Orange	2 poles	JB8-2	1SNK908302R0000	50	2.70
		3 poles	JB8-3	1SNK908303R0000	50	4.10
		4 poles	JB8-4	1SNK908304R0000	50	5.60
		5 poles	JB8-5	1SNK908305R0000	40	7.00
		10 poles	JB8-10	1SNK908310R0000	20	14.20
4 Cross spacing jumpers	Orange	JB85-3	1SNK900603R0000	10	2.80	
5 Circuit separators	Dark grey	CS-R3	1SNK900107R0000	20	6.40	
6 Test adapters	Dark grey	For test plugs DIA 2 mm 0.079 in	TP2	1SNK900203R0000	20	1.70
		For test plugs DIA 4 mm 0.157 in	TP4	1SNK900205R0000	20	2.40
7 Test connectors	Dark grey	TC5-R1	1SNK900201R0000	10	5.20	
8 Spacers	Dark grey	ES-TC8	1SNK900104R0000	10	1.40	
		MG-CPM 13 41791	1SNB041791R0612	1680	0.27	
		MC812	1SNK160000R0000	22	10.00	
9 Terminal block markers	White	Blank card	1SNK169999R0000	20	14.00	
		Universal wire markers holder	Grey	UMH	1SNK900611R0000	10

Complete list of accessories is indicated in the terminal block datasheet including end stops. Some accessories such as jumper bars may modify the terminal block's ratings: Complete information available in the accessories section of the catalog.

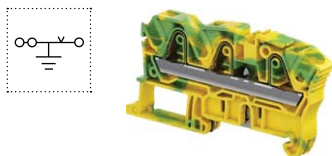
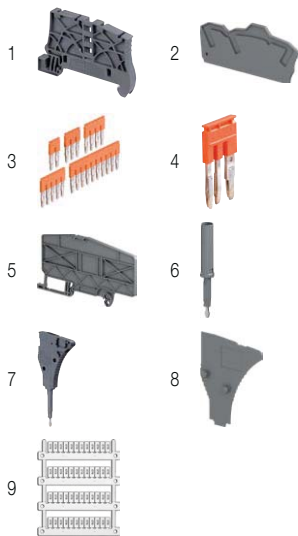

Ground PI-Spring terminal blocks

Description	Color	Type	Part Number	Pkg qty	Weight (1 pce) g
Ground	Green-yellow	ZK6-PE-3P	1SNK708151R0000	20	21.50

Technical data valid for copper conductors only.

ZK10 PI-Spring terminal blocks

Feed-through - 10 mm 0.394 in spacing

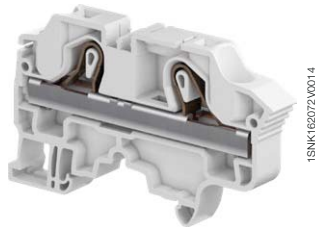

ZK10

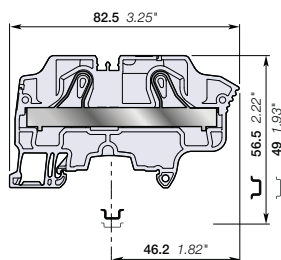

10 mm 0.394 in spacing

Description

Combine high performance with compact dimensions:

- 1000 V AC / DC IEC 600 V UL,
- Opt for the best marking visibility thanks to the up-front, flat marker zone, which lets you mark up to eight digits or increase the font size.

Ordering details

Description	Color	Type	Part Number	Pkg qty	Weight (1 pce) g
Feed-through 2 connections	Grey <input type="checkbox"/>	ZK10	1SNK710010R0000	20	27.20
	Blue <input type="checkbox"/>	ZK10-BL	1SNK710020R0000	20	27.20
	Orange <input type="checkbox"/>	ZK10-OR	1SNK710030R0000	20	27.20

Main technical data

Connecting capacity	IEC	UL - CSA	Mounting instructions
1 conductor per clamp	Rigid: Solid/Stranded	0.5 ... 16 mm ²	20 ... 6 AWG
	Flexible without ferrule	0.5 ... 10 mm ²	20 ... 8 AWG
	Flexible with non insulated ferrule	0.5 ... 10 mm ²	20 ... 8 AWG
	Flexible with insulated ferrule	0.5 ... 10 mm ²	20 ... 8 AWG
2 conductors per clamp	Flexible with twin ferrule	0.5 ... 4 mm ²	20 ... 12 AWG
Rated current / Rated cross section		57 A / 10 mm ²	55 A / 6 AWG
Rated short-time withstand current (1s)		1200 A	1596 A
Short Circuit Current Rating (with specific conditions)			100 kA
Rated voltage		1000 V	600 V
Impulse withstand voltage		8000 V	
Protection		IP20	NEMA 1
Increased safety Ex e		693 V 51 A IEC/EN 60079-7 - IM2 II 2 GD Ex eb I/II/C/IIIC	

The connecting capacity data for one Rigid: Solid/Stranded, or one Flexible conductor (when applicable) is a mandatory information required by IEC, UL and CSA standards (Copper conductors). All other data are provided as supplementary information only. For more details, please consult our CB, UL or CSA certificates and technical datasheet available on <http://www.TE.com>

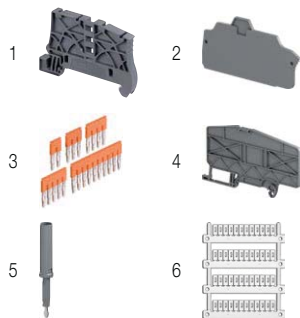

Accessories

Description	Color	Type	Part Number	Pkg qty	Weight (1 pce) g	
1 End stops	Dark grey <input type="checkbox"/>	BAZ1	1SNK900002R0000	50	5.30	
2 End sections	Dark grey <input type="checkbox"/>	EK10	1SNK710910R0000	20	3.30	
3 Jumper bars	Orange <input type="checkbox"/>	2 poles	JB10-2	1SNK910302R0000	50	4.60
		3 poles	JB10-3	1SNK910303R0000	50	7.10
		4 poles	JB10-4	1SNK910304R0000	40	9.40
		5 poles	JB10-5	1SNK910305R0000	30	12.00
		10 poles	JB10-10	1SNK910310R0000	20	24.00
4 Circuit separators	Dark grey <input type="checkbox"/>	CS-R3	1SNK900107R0000	20	6.40	
5 Test adapters	Dark grey <input type="checkbox"/>	For test plugs DIA 2 mm 0.079 in	TP2	1SNK900203R0000	20	1.70
		For test plugs DIA 4 mm 0.157 in	TP4	1SNK900205R0000	20	2.40
6 Terminal block markers	White <input type="checkbox"/>	Blank marker	MG-CPM 13 41791	1SNB041791R0612	1680	0.27
		Blank card	MC812	1SNK160000R0000	22	10.00
			MC812PA	1SNK169999R0000	20	14.00
	Universal wire markers holder	Grey <input type="checkbox"/>	UMH	1SNK900611R0000	10	0.20

Complete list of accessories is indicated in the terminal block datasheet including end stops.

Some accessories such as jumper bars may modify the terminal block's ratings: Complete information available in the accessories section of the catalog.

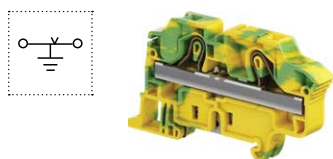

Ground PI-Spring terminal blocks

Description	Color	Type	Part Number	Pkg qty	Weight (1 pce) g
Ground	Green-yellow <input type="checkbox"/>	ZK10-PE	1SNK710150R0000	20	36.20

Technical data valid for copper conductors only.

ZK10-PV PI-Spring terminal blocks

Feed-through - 12 mm 0.472 in spacing

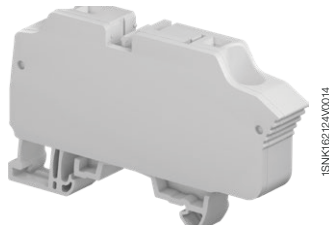
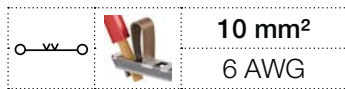

Description

Specially designed for high voltage utility scale solar power plants:

- Rated voltage of 1500 V DC IEC and 1000 V DC UL,
- Pre-mounted end section with light grey color specific to this application,
- Improved design with ribs to increase creepage distance,
- Compact solution only 2 mm thicker than normal product,
- Compatible with JB12 jumpers to interconnect multiple terminal blocks.

Ordering details

Description	Color	Type	Part Number	Pkg qty	Weight (1 pce) g
Feed-through 2 connections	Grey	ZK10-PV	1SNK710063R0000	20	29.86
	Blue	ZK10-PV-BL	1SNK710065R0000	20	29.86

Main technical data

Connecting capacity	IEC	UL - CSA	Mounting instructions
1 conductor per clamp	Rigid: Solid/Stranded	0.5 ... 16 mm ²	20 ... 6 AWG
	Flexible without ferrule	0.5 ... 10 mm ²	20 ... 8 AWG
	Flexible with non insulated ferrule	0.5 ... 10 mm ²	20 ... 8 AWG
	Flexible with insulated ferrule	0.5 ... 10 mm ²	20 ... 8 AWG
2 conductors per clamp	Flexible with twin ferrule	0.5 ... 4 AWG	20 ... 12 AWG
Rated current / Rated cross section		57 A / 10 mm ²	55 A / 6 AWG
Rated short-time withstand current (1s)		1200 A	1596 A
Short Circuit Current Rating (with specific conditions)			100 kA
Rated voltage		1000 V AC / 1500 V DC	1000 V
Impulse withstand voltage		8000 V	
Protection		IP20	NEMA 1

Mounting instructions

Rail		TH 35-7.5, TH 35-15
Wire stripping length		15 mm 0.591 in
Tool (for flexible conductor without ferrule)		Flat screwdriver Ø 4 mm Ø 0.157 in

ZK10-PV

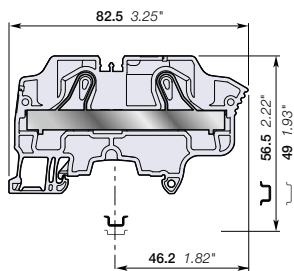

12 mm 0.472 in spacing

The connecting capacity data for one Rigid: Solid/Stranded, or one Flexible conductor (when applicable) is a mandatory information required by IEC, UL and CSA standards (Copper conductors). All other data are provided as supplementary information only. For more details, please consult our CB, UL or CSA certificates and technical datasheet available on <http://www.TE.com>

CE	IEC CB	RoHS	UL	CSA	EAC														
----	--------	------	----	-----	-----	--	--	--	--	--	--	--	--	--	--	--	--	--	--

Accessories

Description	Color	Type	Part Number	Pkg qty	Weight (1 pce) g	
1 End stops	Dark grey	BAZ1	1SNK900002R0000	50	5.30	
2 Jumper bars	Orange	2 poles	JB12-2	1SNK912302R0000	50	4.90
		3 poles	JB12-3	1SNK912303R0000	50	7.60
		5 poles	JB12-5	1SNK912305R0000	20	12.90
3 Circuit separators	Dark grey	CS-R3	1SNK900107R0000	20	6.40	
4 Test adapters	Dark grey	For test plugs DIA 2 mm 0.079 in	TP2	1SNK900203R0000	20	1.70
		For test plugs DIA 4 mm 0.157 in	TP4	1SNK900205R0000	20	2.40
5 Terminal block markers	White	MC812	1SNK160000R0000	22	10.00	
		MC812PA	1SNK169999R0000	20	14.00	
	Blank marker	MG-CPM 13 41791	1SNK041791R0612	1680	0.273	
Universal wire markers holder	Grey	UMH	1SNK900611R0000	10	0.20	

Complete list of accessories is indicated in the terminal block datasheet including end stops. Some accessories such as jumper bars may modify the terminal block's ratings: Complete information available in the accessories section of the catalog.



Ground PI-Spring terminal blocks

Description	Color	Type	Part Number	Pkg qty	Weight (1 pce) g
Ground	Green-yellow	ZK10-PE	1SNK710150R0000	20	36.20

Technical data valid for copper conductors only.

ZK10-3P PI-Spring terminal blocks

Feed-through with 3 connections - 10 mm 0.394 in spacing



ZK10-3P

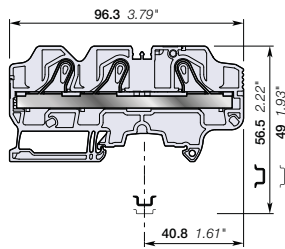

10 mm 0.394 in spacing

Description

- Find all the features of the ZK10 terminal block with the added option of distributing or branching 3 conductors,
- ZK10-3P is perfectly adapted to solar applications: 1250 V DC (1000 V AC) IEC, 1000 V UL.

Ordering details

Description	Color	Type	Part Number	Pkg qty	Weight (1 pce) g
Feed-through 3 connections	Grey <input type="checkbox"/>	ZK10-3P	1SNK710011R0000	20	34.9
	Blue <input type="checkbox"/>	ZK10-3P-BL	1SNK710021R0000	20	34.9

Main technical data

Connecting capacity	IEC	UL - CSA	Rail	Mounting instructions
1 conductor per clamp	Rigid: Solid/Stranded	0.5 ... 16 mm ²	20 ... 6 AWG	 Wire stripping length 15 mm 0.591 in
	Flexible without ferrule	0.5 ... 10 mm ²		
	Flexible with non insulated ferrule	0.5 ... 10 mm ²	20 ... 8 AWG	
	Flexible with insulated ferrule	0.5 ... 10 mm ²	20 ... 8 AWG	
2 conductors per clamp	Flexible with twin ferrule	0.5 ... 4 mm ²	20 ... 12 AWG	 Tool (for flexible conductor without ferrule) Flat screwdriver Ø 4 mm Ø 0.157 in
Rated current / Rated cross section		57 A / 10 mm ²	56 A / 6 AWG	
Rated short-time withstand current (1s)		1200 A		
Short Circuit Current Rating (with specific conditions)			100 kA	
Rated voltage		1000 V	1000 V	
Impulse withstand voltage		8000 V		
Protection		IP20	NEMA 1	
Increased safety Ex e		693 V 57 A - IM2 II 2 GD Ex eb I/II/III C		

The connecting capacity data for one Rigid: Solid/Stranded, or one Flexible conductor (when applicable) is a mandatory information required by IEC, UL and CSA standards (Copper conductors). All other data are provided as supplementary information only. For more details, please consult our CB, UL or CSA certificates and technical datasheet available on <http://www.TE.com>

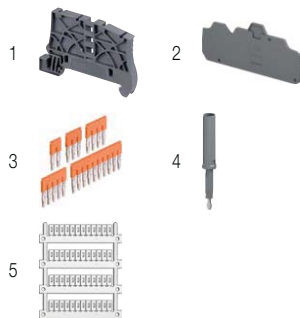

Accessories

Description	Color	Type	Part Number	Pkg qty	Weight (1 pce) g	
1 End stops	Dark grey <input type="checkbox"/>	BAZ1	1SNK900002R0000	50	5.30	
2 End sections	Dark grey <input type="checkbox"/>	EK10-3P	1SNK710911R0000	20	4.5	
3 Jumper bars	Orange <input type="checkbox"/>	2 poles	JB10-2	1SNK910302R0000	50	4.60
		3 poles	JB10-3	1SNK910303R0000	50	7.10
		4 poles	JB10-4	1SNK910304R0000	40	9.40
		5 poles	JB10-5	1SNK910305R0000	30	12.00
		10 poles	JB10-10	1SNK910310R0000	20	24.00
4 Test adapters	Dark grey <input type="checkbox"/>	For test plugs DIA 2 mm 0.079 in	TP2	1SNK900203R0000	20	1.70
		For test plugs DIA 4 mm 0.157 in	TP4	1SNK900205R0000	20	2.40
5 Terminal block markers	White <input type="checkbox"/>	Blank marker	MG-CPM 13 41791	1SNB041791R0612	1680	0.27
		Blank card	MC812	1SNK160000R0000	22	10.00
			MC812PA	1SNK169999R0000	20	14.00
		Universal wire markers holder	Grey <input type="checkbox"/>	UMH	1SNK900611R0000	10

Complete list of accessories is indicated in the terminal block datasheet including end stops.

Some accessories such as jumper bars may modify the terminal block's ratings: Complete information available in the accessories section of the catalog.



Ground PI-Spring terminal blocks

Description	Color	Type	Part Number	Pkg qty	Weight (1 pce) g
Ground	Green-yellow <input type="checkbox"/>	ZK10-PE-3P	1SNK710151R0000	20	43.3

Technical data valid for copper conductors only.

ZK10-3P-PV PI-Spring terminal blocks

Feed-through with 3 connections - 12 mm 0.472 in spacing

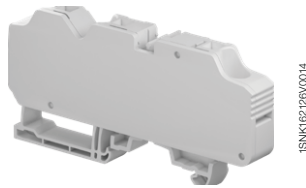
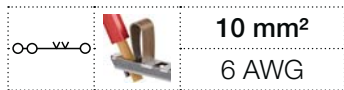

ZK10-3P-PV

Description

Specially designed for high voltage utility scale solar power plants:

- Rated voltage of 1500 V DC IEC and 1000 V DC UL,
- Pre-mounted end section with light grey color specific to this application,
- Improved design with ribs to increase creepage distance,
- Compact solution only 2 mm thicker than normal product,
- 3 connections configuration for easy grouping: 2 inputs / 1 output or 1 input / 2 outputs,
- Compatible with JB12 jumpers to interconnect multiple terminal blocks.

Description	Color	Type	Part Number	Pkg qty	Weight (1 pce) g
Feed-through 3 connections	Grey	ZK10-3P-PV	1SNK710064R0000	20	38.61
	Blue	ZK10-3P-PV-BL	1SNK710067R0000	20	38.61

Main technical data

Connecting capacity		IEC	UL - CSA	Mounting instructions	
1 conductor per clamp	Rigid: Solid/Stranded	0.5 ... 16 mm ²	20 ... 6 AWG	Rail	TH 35-7.5, TH 35-15
	Flexible without ferrule	0.5 ... 10 mm ²			Wire stripping length
	Flexible with non insulated ferrule	0.5 ... 10 mm ²	20 ... 8 AWG	Tool (for flexible conductor without ferrule)	
	Flexible with insulated ferrule	0.5 ... 10 mm ²	20 ... 8 AWG		
2 conductors per clamp	Flexible with twin ferrule	0.5 ... 4 AWG	20 ... 12 AWG		
Rated current / Rated cross section		57 A / 10 mm ²	56 A / 6 AWG		
Rated short-time withstand current (1s)		1200 A	1596 A		
Short Circuit Current Rating (with specific conditions)			100 kA		
Rated voltage		1000 V AC / 1500 V DC	1000 V		
Impulse withstand voltage		8000 V			
Protection		IP20	NEMA 1		

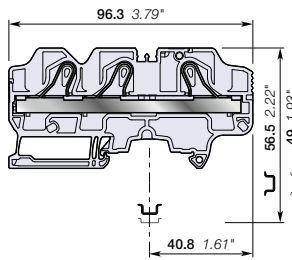

12 mm 0.472 in spacing

The connecting capacity data for one Rigid: Solid/Stranded, or one Flexible conductor (when applicable) is a mandatory information required by IEC, UL and CSA standards (Copper conductors). All other data are provided as supplementary information only. For more details, please consult our CB, UL or CSA certificates and technical datasheet available on <http://www.TE.com>

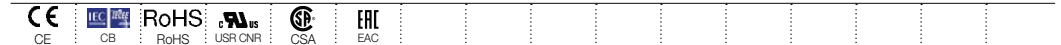

Accessories

Description	Color	Type	Part Number	Pkg qty	Weight (1 pce) g	
1 End stops	Dark grey	BAZ1	1SNK900002R0000	50	5.30	
2 Jumper bars	Orange	2 poles	JB12-2	1SNK912302R0000	50	4.90
		3 poles	JB12-3	1SNK912303R0000	50	7.60
		5 poles	JB12-5	1SNK912305R0000	20	12.90
3 Circuit separators	Dark grey	CS-R3	1SNK900107R0000	20	6.40	
4 Test adapters	Dark grey	For test plugs DIA 2 mm 0.079 in	TP2	1SNK900203R0000	20	1.70
		For test plugs DIA 4 mm 0.157 in	TP4	1SNK900205R0000	20	2.40
5 Terminal block markers	White	Blank card	MC812	1SNK160000R0000	22	10.00
			MC812PA	1SNK169999R0000	20	14.00
	Blank marker	MG-CPM 13 41791	1SNB041791R0612	1680	0.273	
Universal wire markers holder	Grey	UMH	1SNK900611R0000	10	0.20	

Complete list of accessories is indicated in the terminal block datasheet including end stops. Some accessories such as jumper bars may modify the terminal block's ratings: Complete information available in the accessories section of the catalog.



Ground PI-Spring terminal blocks

Description	Color	Type	Part Number	Pkg qty	Weight (1 pce) g
Ground	Green-yellow	ZK10-PE-3P	1SNK710151R0000	20	43.3

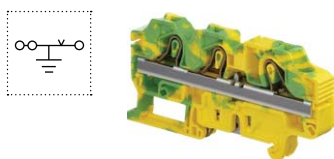

Technical data valid for copper conductors only.

ZK16 PI-Spring terminal blocks

Feed-through - 12 mm 0.472 in spacing



16 mm²
4 AWG

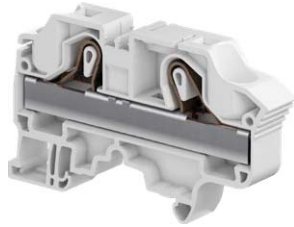

1SNK162075V0014

ZK16

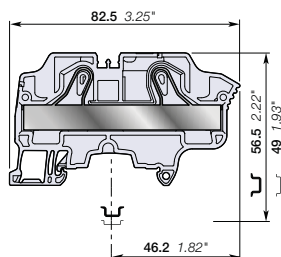

12 mm 0.472 in spacing

Description

Combine high performance with compact dimensions:

- 1000 V AC / DC IEC 600 V UL,
- Opt for the best marking visibility thanks to the up-front, flat marker zone, which lets you mark up to eight digits or increase the font size.

Ordering details

Description	Color	Type	Part Number	Pkg qty	Weight (1 pce) g
Feed-through 2 connections	Grey <input type="checkbox"/>	ZK16	1SNK712010R0000	20	33.80
	Blue <input type="checkbox"/>	ZK16-BL	1SNK712020R0000	20	33.80

Main technical data

Connecting capacity		IEC	UL - CSA	Mounting instructions	
1 conductor per clamp	Rigid: Solid/Stranded	0.5 ... 25 mm ²	20 ... 4 AWG	Rail	TH 35-7.5, TH 35-15
	Flexible without ferrule	0.5 ... 16 mm ²	20 ... 6 AWG	Wire stripping length	15 mm 0.591 in
	Flexible with non insulated ferrule	0.5 ... 16 mm ²	20 ... 6 AWG		
	Flexible with insulated ferrule	0.5 ... 16 mm ²	20 ... 6 AWG		
2 conductors per clamp	Flexible with twin ferrule	0.5 ... 6 mm ²	20 ... 10 AWG	Tool (for flexible conductor without ferrule)	Flat screwdriver Ø 4 mm Ø 0.157 in
Rated current / Rated cross section		76 A / 16 mm ²	75 A / 4 AWG		
Rated short-time withstand current (1s)		1920 A	2544 A		
Short Circuit Current Rating (with specific conditions)			100 kA		
Rated voltage		1000 V	600 V		
Impulse withstand voltage		8000 V			
Protection		IP20	NEMA 1		
Increased safety Ex e		693 V 69 A IEC/EN 60079-7 - IM2 II 2 GD Ex eb I/II/III/C			

The connecting capacity data for one Rigid: Solid/Stranded, or one Flexible conductor (when applicable) is a mandatory information required by IEC, UL and CSA standards (Copper conductors). All other data are provided as supplementary information only. For more details, please consult our CB, UL or CSA certificates and technical datasheet available on <http://www.TE.com>

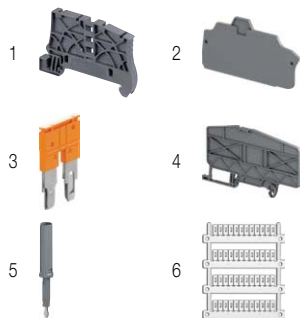

Accessories

Description	Color	Type	Part Number	Pkg qty	Weight (1 pce) g
1 End stops	Dark grey <input type="checkbox"/>	BAZ1	1SNK900002R0000	50	5.30
2 End sections	Dark grey <input type="checkbox"/>	EK10	1SNK710910R0000	20	3.30
3 Jumper bars	Orange <input type="checkbox"/>	JB12-2	1SNK912302R0000	50	4.90
		JB12-3	1SNK912303R0000	50	7.60
		JB12-5	1SNK912305R0000	20	12.90
4 Circuit separators	Dark grey <input type="checkbox"/>	CS-R3	1SNK900107R0000	20	6.40
5 Test adapters	Dark grey <input type="checkbox"/>	TP2	1SNK900203R0000	20	1.70
		TP4	1SNK900205R0000	20	2.40
6 Terminal block markers	White <input type="checkbox"/>	MG-CPM 13 41791	1SNB041791R0612	1680	0.27
		MC812	1SNK160000R0000	22	10.00
		MC812PA	1SNK169999R0000	20	14.00
		Universal wire markers holder	Grey <input type="checkbox"/>	UMH	1SNK900611R0000

Complete list of accessories is indicated in the terminal block datasheet including end stops.

Some accessories such as jumper bars may modify the terminal block's ratings: Complete information available in the accessories section of the catalog.



Ground PI-Spring terminal blocks

Description	Color	Type	Part Number	Pkg qty	Weight (1 pce) g
Ground	Green-yellow <input type="checkbox"/>	ZK16-PE	1SNK712150R0000	20	47.00

Technical data valid for copper conductors only.

ZK16-PV PI-Spring terminal blocks

Feed-through - 14 mm 0.551 in spacing

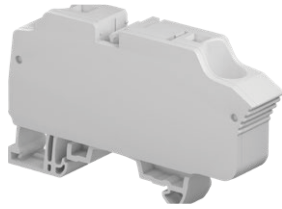

1SNK162128V0014

Description

- Specially designed for high voltage utility scale solar power plants:
- Rated voltage of 1500 V DC IEC and 1000 V DC UL,
 - Pre-mounted end section with light grey color specific to this application,
 - Improved design with ribs to increase creepage distance,
 - Compact solution only 2 mm thicker than normal product,
 - No available jumpers for ZK16-PV and ZK16-3P-PV (14 mm spacing).

Ordering details

Description	Color	Type	Part Number	Pkg qty	Weight (1 pce) g
Feed-through 2 connections	Grey <input type="checkbox"/>	ZK16-PV	1SNK712063R0000	15	36.56
	Blue <input type="checkbox"/>	ZK16-PV-BL	1SNK712065R0000	15	36.56

Main technical data

Connecting capacity	IEC	UL - CSA	Mounting instructions	
1 conductor per clamp	Rigid: Solid/Stranded	0.5 ... 25 mm ²	20 ... 4 AWG	Rail TH 35-7.5, TH 35-15
	Flexible without ferrule	0.5 ... 16 mm ²	20 ... 4 AWG	Wire stripping length 15 mm 0.591 in
	Flexible with non insulated ferrule	0.5 ... 16 mm ²	20 ... 6 AWG	Tool (for flexible conductor without ferrule) Flat screwdriver Ø 4 mm Ø 0.157 in
	Flexible with insulated ferrule	0.5 ... 16 mm ²	20 ... 6 AWG	
2 conductors per clamp	Flexible with twin ferrule	0.5 ... 6 AWG	20 ... 10 AWG	
Rated current / Rated cross section		76 A / 16 mm ²	75 A / 4 AWG	
Rated short-time withstand current (1s)		1920 A	2544 A	
Short Circuit Current Rating (with specific conditions)			100 kA	
Rated voltage		1000 V AC / 1500 V DC	1000 V	
Impulse withstand voltage		8000 V		
Protection		IP20	NEMA 1	

ZK16-PV

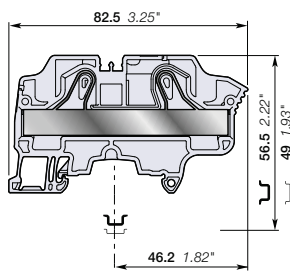

14 mm 0.551 in spacing

The connecting capacity data for one Rigid: Solid/Stranded, or one Flexible conductor (when applicable) is a mandatory information required by IEC, UL and CSA standards (Copper conductors). All other data are provided as supplementary information only. For more details, please consult our CB, UL or CSA certificates and technical datasheet available on <http://www.TE.com>

--	--	--	--	--	--	--	--	--	--

Accessories

Description	Color	Type	Part Number	Pkg qty	Weight (1 pce) g
1 End stops	Dark grey <input checked="" type="checkbox"/>	BAZ1	1SNK900002R0000	50	5.30
2 Circuit separators	Dark grey <input checked="" type="checkbox"/>	CS-R3	1SNK900107R0000	20	6.40
3 Test adapters	Dark grey <input checked="" type="checkbox"/>	TP2	1SNK900203R0000	20	1.70
		TP4	1SNK900205R0000	20	2.40
4 Terminal block markers	White <input type="checkbox"/>	MC812	1SNK160000R0000	22	10.00
		MC812PA	1SNK169999R0000	20	14.00
		MG-CPM 13 41791	1SNB041791R0612	1680	0.273
	Grey <input type="checkbox"/>	UMH	1SNK900611R0000	10	0.20

Complete list of accessories is indicated in the terminal block datasheet including end stops. Some accessories such as jumper bars may modify the terminal block's ratings. Complete information available in the accessories section of the catalog.

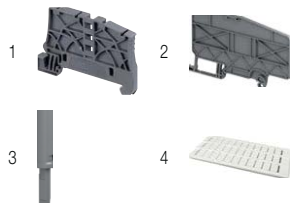

Ground PI-Spring terminal blocks

Description	Color	Type	Part Number	Pkg qty	Weight (1 pce) g
Ground Profile aligned with ZK16	Green-yellow <input checked="" type="checkbox"/>	ZK16-PE	1SNK712150R0000	20	47.00

Technical data valid for copper conductors only.

ZK16-3P PI-Spring terminal blocks

Feed-through with 3 connections - 12 mm 0.472 in spacing

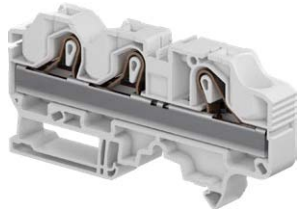

ZK16-3P

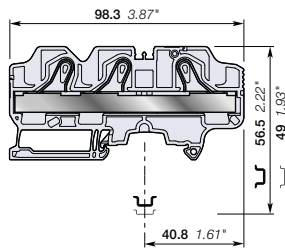

12 mm 0.472 in spacing

Description

- Find all the features of the ZK16 terminal block with the added option of distributing or branching 3 conductors,
- ZK16-3P is perfectly adapted to solar applications: 1250 V DC (1000 V AC) IEC, 1000 V UL.

Ordering details

Description	Color	Type	Part Number	Pkg qty	Weight (1 pce) g
Feed-through 3 connections	Grey	ZK16-3P	1SNK712011R0000	20	44.3
	Blue	ZK16-3P-BL	1SNK712021R0000	20	44.3

Main technical data

Connecting capacity	IEC	UL - CSA	Rail	Wire stripping length	TH 35-7.5, TH 35-15
1 conductor per clamp	Rigid: Solid/Stranded	0.5 ... 25 mm ²	20 ... 4 AWG	15 mm	0.591 in
	Flexible without ferrule	0.5 ... 16 mm ²			
	Flexible with non insulated ferrule	0.5 ... 16 mm ²	20 ... 6 AWG		
	Flexible with insulated ferrule	0.5 ... 16 mm ²	20 ... 6 AWG		
2 conductors per clamp	Flexible with twin ferrule	0.5 ... 6 mm ²	20 ... 10 AWG	Tool (for flexible conductor without ferrule)	Flat screwdriver Ø 4 mm Ø 0.157 in
Rated current / Rated cross section		76 A / 16 mm ²	75 A / 4 AWG		
Rated short-time withstand current (1s)		1920 A			
Short Circuit Current Rating (with specific conditions)			100 kA		
Rated voltage		1000 V	1000 V		
Impulse withstand voltage		8000 V			
Protection		IP20	NEMA 1		
Increased safety Ex e		693 V 76 A - IM2 II 2 GD Ex eb I/IIIC			

The connecting capacity data for one Rigid: Solid/Stranded, or one Flexible conductor (when applicable) is a mandatory information required by IEC, UL and CSA standards (Copper conductors). All other data are provided as supplementary information only. For more details, please consult our CB, UL or CSA certificates and technical datasheet available on <http://www.TE.com>

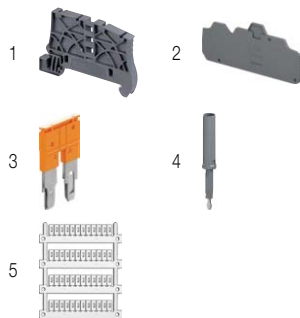

Accessories

Description	Color	Type	Part Number	Pkg qty	Weight (1 pce) g	
1 End stops	Dark grey	BAZ1	1SNK900002R0000	50	5.30	
2 End sections	Dark grey	EK10-3P	1SNK710911R0000	20	4.5	
3 Jumper bars	Orange	2 poles	JB12-2	1SNK912302R0000	50	4.90
		3 poles	JB12-3	1SNK912303R0000	50	7.60
		5 poles	JB12-5	1SNK912305R0000	20	12.90
4 Test adapters	Dark grey	For test plugs DIA 2 mm 0.079 in	TP2	1SNK900203R0000	20	1.70
		For test plugs DIA 4 mm 0.157 in	TP4	1SNK900205R0000	20	2.40
5 Terminal block markers	White	Blank marker	MG-CPM 13 41791	1SNB041791R0612	1680	0.27
		Blank card	MC812	1SNK160000R0000	22	10.00
			MC812PA	1SNK169999R0000	20	14.00
	Universal wire markers holder	Grey	UMH	1SNK900611R0000	10	0.20

Complete list of accessories is indicated in the terminal block datasheet including end stops.

Some accessories such as jumper bars may modify the terminal block's ratings: Complete information available in the accessories section of the catalog.

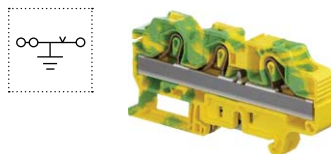

Ground PI-Spring terminal blocks

Description	Color	Type	Part Number	Pkg qty	Weight (1 pce) g
Ground	Green-yellow	ZK16-PE-3P	1SNK712151R0000	20	56.65

Technical data valid for copper conductors only.

ZK16-3P-PV PI-Spring terminal blocks

Feed-through with 3 connections - 14 mm 0.551 in spacing

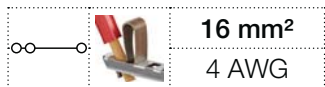

16 mm²
4 AWG

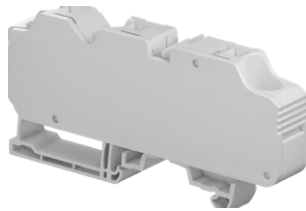

1SNK162130V0004

ZK16-3P-PV

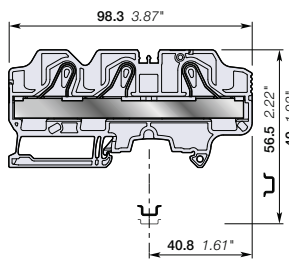

14 mm 0.551 in spacing

Description

Specially designed for high voltage utility scale solar power plants:

- Rated voltage of 1500 V DC IEC and 1000 V DC UL,
- Pre-mounted end section with light grey color specific to this application,
- Improved design with ribs to increase creepage distance,
- Compact solution only 2 mm thicker than normal product,
- 3 connections configuration for easy grouping: 2 inputs / 1 output or 1 input / 2 outputs,
- No available jumpers for ZK16-PV and ZK16-3P-PV (14 mm spacing).

Ordering details

Description	Color	Type	Part Number	Pkg qty	Weight (1 pce) g
Feed-through 3 connections	Grey	ZK16-3P-PV	1SNK712064R0000	15	48.01
	Blue	ZK16-3P-PV-BL	1SNK712067R0000	15	48.01

Main technical data

Connecting capacity		IEC	UL - CSA	Mounting instructions	
1 conductor per clamp	Rigid: Solid/Stranded	0.5 ... 25 mm ²	20 ... 4 AWG	Rail	TH 35-7.5, TH 35-15
	Flexible without ferrule	0.5 ... 16 mm ²		Wire stripping length	15 mm 0.591 in
	Flexible with non insulated ferrule	0.5 ... 16 mm ²	20 ... 6 AWG		
	Flexible with insulated ferrule	0.5 ... 16 mm ²	20 ... 6 AWG		
2 conductors per clamp	Flexible with twin ferrule	0.5 ... 6 AWG	20 ... 10 AWG	Tool (for flexible conductor without ferrule)	Flat screwdriver Ø 4 mm Ø 0.157 in
Rated current / Rated cross section		76 A / 16 mm ²	75 A / 4 AWG		
Rated short-time withstand current (1s)		1920 A	2544 A		
Short Circuit Current Rating (with specific conditions)			100 kA		
Rated voltage		1000 V AC / 1500 V DC	1000 V		
Impulse withstand voltage		8000 V			
Protection		IP20	NEMA 1		

The connecting capacity data for one Rigid: Solid/Stranded, or one Flexible conductor (when applicable) is a mandatory information required by IEC, UL and CSA standards (Copper conductors). All other data are provided as supplementary information only. For more details, please consult our CB, UL or CSA certificates and technical datasheet available on <http://www.TE.com>

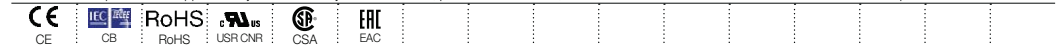

Accessories

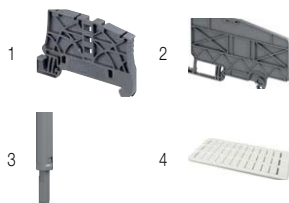

Description	Color	Type	Part Number	Pkg qty	Weight (1 pce) g
1 End stops 5.2 mm 0.205 in	Dark grey	BAZ1	1SNK900002R0000	50	5.30
2 Circuit separators 3 mm 0.118 in	Dark grey	CS-R3	1SNK900107R0000	20	6.40
3 Test adapters For test plugs DIA 2 mm 0.079 in	Dark grey	TP2	1SNK900203R0000	20	1.70
		TP4	1SNK900205R0000	20	2.40
4 Terminal block markers	White	MC812	1SNK160000R0000	22	10.00
		MC812PA	1SNK169999R0000	20	14.00
		MG-CPM 13 41791	1SNB041791R0612	1680	0.273
	Universal wire markers holder	Grey	UMH	1SNK900611R0000	10

Complete list of accessories is indicated in the terminal block datasheet including end stops.

Some accessories such as jumper bars may modify the terminal block's ratings: Complete information available in the accessories section of the catalog.



Ground PI-Spring terminal blocks

Description	Color	Type	Part Number	Pkg qty	Weight (1 pce) g
Ground Profile aligned with ZK16-3P	Green-yellow	ZK16-PE-3P	1SNK712151R0000	20	56.65

Technical data valid for copper conductors only.

ZK2.5-PE PI-Spring terminal blocks

Ground - 5.2 mm 0.205 in spacing



ZK2.5-PE

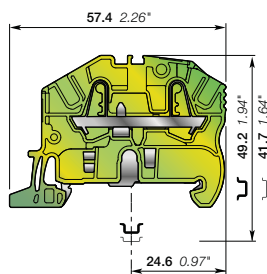

5.2 mm 0.205 in spacing

Description

Improve the safety of your installation in the event of a short-circuit thanks to our screwless rail contact:

- Rail contact non operator dependent,
- Performances above the requirements of the IEC 60947-7-2 terminal block standard,
- Secured snap on or off the rail,
- Profile aligned with ZK2.5.

Ordering details

Description	Color	Type	Part Number	Pkg qty	Weight (1 pce) g
Ground 2 connections	Green-yellow	ZK2.5-PE	1SNK705150R0000	20	10.00

Main technical data

Connecting capacity		IEC	UL - CSA	Mounting instructions
1 conductor per clamp	Rigid: Solid/Stranded	0.2 ... 4 mm²	26 ... 12 AWG	Rail
	Flexible without ferrule	0.22 ... 2.5 mm²		Wire stripping length
	Flexible with non insulated ferrule	0.22 ... 2.5 mm²	26 ... 14 AWG	
	Flexible with insulated ferrule	0.22 ... 2.5 mm²	26 ... 14 AWG	
Rated cross section		2.5 mm²	12 AWG	Tool (for flexible conductor without ferrule)
Rated short-time withstand current (1s)		300 A	396 A	Flat screwdriver Ø 3.5 mm Ø 0.138 in
Protection		IP20	NEMA 1	
Explosive atmosphere classification		IM2 II 2 GD Ex eb I/IC/IIIC - Class I, Zone 1, AEx e II, Ex e II U		

The connecting capacity data for one Rigid: Solid/Stranded, or one Flexible conductor (when applicable) is a mandatory information required by IEC, UL and CSA standards (Copper conductors). All other data are provided as supplementary information only. For more details, please consult our CB, UL or CSA certificates and technical datasheet available on <http://www.TE.com>

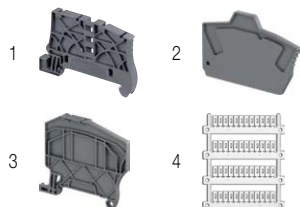

Accessories

Description	Color	Type	Part Number	Pkg qty	Weight (1 pce) g
1 End stops	Dark grey	BAZ1	1SNK900002R0000	50	5.30
2 End sections	Dark grey	EK2.5	1SNK705910R0000	20	1.80
3 Circuit separators	Dark grey	CS-R2	1SNK900106R0000	20	3.80
4 Terminal block markers	White	MG-CPM 13 41790	1SNB041790R0512	1960	0.23
		MC512	1SNK140000R0000	22	9.00
		MC512PA	1SNK149999R0000	20	10.00
Universal wire markers holder	Grey	UMH	1SNK900611R0000	10	0.20

Complete list of accessories is indicated in the terminal block datasheet including end stops.

Some accessories such as jumper bars may modify the terminal block's ratings: Complete information available in the accessories section of the catalog.

Technical data valid for copper conductors only.

ZK2.5-PE-3P PI-Spring terminal blocks

Ground with 3 connections - 5.2 mm 0.205 in spacing



ZK2.5-PE-3P

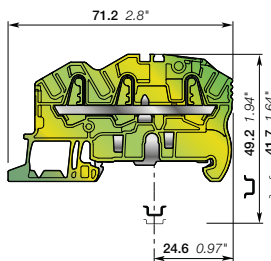

5.2 mm 0.205 in spacing

Description

Improve the safety of your installation in the event of a short-circuit thanks to our screwless rail contact:

- Rail contact non operator dependent,
- Performances above the requirements of the IEC 60947-7-2 terminal block standard,
- Secured snap on or off the rail,
- Profile aligned with ZK2.5-3P.

Ordering details

Description	Color	Type	Part Number	Pkg qty	Weight (1 pce) g
Ground 3 connections	Green-yellow	ZK2.5-PE-3P	1SNK705151R0000	20	11.90

Main technical data

Connecting capacity	IEC	UL - CSA	Mounting instructions		
1 conductor per clamp	Rigid: Solid/Stranded	0.2 ... 4 mm ²	26 ... 12 AWG	Rail	TH 35-7.5, TH 35-15
	Flexible without ferrule	0.22 ... 2.5 mm ²	26 ... 14 AWG	Wire stripping length	11 mm 0.433 in
	Flexible with non insulated ferrule	0.22 ... 2.5 mm ²	26 ... 14 AWG	Tool (for flexible conductor without ferrule)	Flat screwdriver Ø 3.5 mm Ø 0.138 in
	Flexible with insulated ferrule	0.22 ... 2.5 mm ²	26 ... 14 AWG		
Rated cross section		2.5 mm ²	12 AWG		
Rated short-time withstand current (1s)		300 A	396 A		
Protection		IP20	NEMA 1		
Explosive atmosphere classification		IM2 II 2 GD Ex eb IIC/IIC - Class I, Zone 1, AEx e II, Ex e II U			

The connecting capacity data for one Rigid: Solid/Stranded, or one Flexible conductor (when applicable) is a mandatory information required by IEC, UL and CSA standards (Copper conductors). All other data are provided as supplementary information only. For more details, please consult our CB, UL or CSA certificates and technical datasheet available on <http://www.TE.com>



Accessories

Description	Color	Type	Part Number	Pkg qty	Weight (1 pce) g
1 End stops	Dark grey	BAZ1	1SNK900002R0000	50	5.30
2 End sections	Dark grey	EK2.5-3P	1SNK705911R0000	20	2.40
3 Circuit separators	Dark grey	CS-R3	1SNK900107R0000	20	6.40
4 Terminal block markers	White	MG-CPM 13 41790	1SNB041790R0512	1960	0.23
		MC512	1SNK140000R0000	22	9.00
		MC512PA	1SNK149999R0000	20	10.00
		Universal wire markers holder	Grey	UMH	1SNK900611R0000

Complete list of accessories is indicated in the terminal block datasheet including end stops. Some accessories such as jumper bars may modify the terminal block's ratings. Complete information available in the accessories section of the catalog.

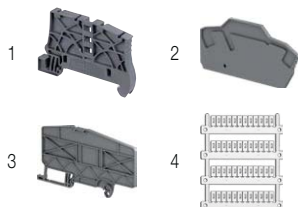

Technical data valid for copper conductors only.

ZK2.5-PE-4P PI-Spring terminal blocks

Ground with 4 connections - 5.2 mm 0.205 in spacing



ZK2.5-PE-4P

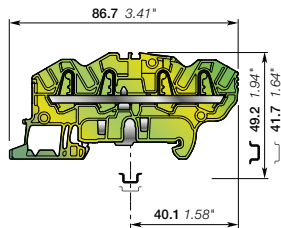

5.2 mm 0.205 in spacing

Description

Improve the safety of your installation in the event of a short-circuit thanks to our screwless rail contact:

- Rail contact non operator dependent,
- Performances above the requirements of the IEC 60947-7-2 terminal block standard,
- Secured snap on or off the rail,
- Profile aligned with ZK2.5-4P.

Ordering details

Description	Color	Type	Part Number	Pkg qty	Weight (1 pce) g
Ground 4 connections	Green-yellow	ZK2.5-PE-4P	1SNK705152R0000	20	13.60

Main technical data

Connecting capacity		IEC	UL - CSA	Mounting instructions	
1 conductor per clamp	Rigid: Solid/Stranded	0.2 ... 4 mm ²	26 ... 12 AWG	Rail	TH 35-7.5, TH 35-15
	Flexible without ferrule	0.22 ... 2.5 mm ²	26 ... 14 AWG	Wire stripping length	11 mm 0.433 in
	Flexible with non insulated ferrule	0.22 ... 2.5 mm ²	26 ... 14 AWG		
	Flexible with insulated ferrule	0.22 ... 2.5 mm ²	26 ... 14 AWG	Tool (for flexible conductor without ferrule)	Flat screwdriver Ø 3.5 mm Ø 0.138 in
Rated cross section		2.5 mm ²	12 AWG		
Rated short-time withstand current (1s)		300 A	396 A		
Protection		IP20	NEMA 1		
Explosive atmosphere classification		IM2 II 2 GD Ex eb I/IC/IIIC - Class I, Zone 1, AEx e II, Ex e II U			

The connecting capacity data for one Rigid: Solid/Stranded, or one Flexible conductor (when applicable) is a mandatory information required by IEC, UL and CSA standards (Copper conductors). All other data are provided as supplementary information only. For more details, please consult our CB, UL or CSA certificates and technical datasheet available on <http://www.TE.com>

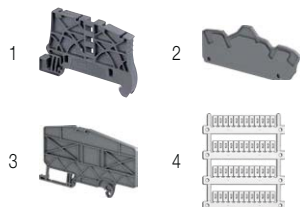

Accessories

Description	Color	Type	Part Number	Pkg qty	Weight (1 pce) g
1 End stops	Dark grey	BAZ1	1SNK900002R0000	50	5.30
2 End sections	Dark grey	EK2.5-4P	1SNK705912R0000	20	2.70
3 Circuit separators	Dark grey	CS-R3	1SNK900107R0000	20	6.40
4 Terminal block markers	White	MG-CPM 13 41790	1SNB041790R0512	1960	0.23
		MC512	1SNK140000R0000	22	9.00
		MC512PA	1SNK149999R0000	20	10.00
Universal wire markers holder	Grey	UMH	1SNK900611R0000	10	0.20

Complete list of accessories is indicated in the terminal block datasheet including end stops.

Some accessories such as jumper bars may modify the terminal block's ratings: Complete information available in the accessories section of the catalog.

Technical data valid for copper conductors only.

ZK4-PE PI-Spring terminal blocks

Ground - 6 mm 0.236 in spacing

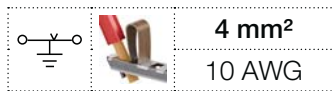

1SNK16206800014

ZK4-PE

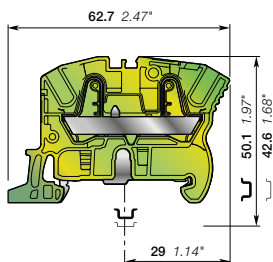

6 mm 0.236 in spacing

Description

Improve the safety of your installation in the event of a short-circuit thanks to our screwless rail contact:

- Rail contact non operator dependent,
- Performances above the requirements of the IEC 60947-7-2 terminal block standard,
- Secured snap on or off the rail,
- Profile aligned with ZK4.

Ordering details

Description	Color	Type	Part Number	Pkg qty	Weight (1 pce) g
Ground 2 connections	Green-yellow	ZK4-PE	1SNK706150R0000	20	12.60

Main technical data

Connecting capacity	IEC	UL - CSA	Mounting instructions		
1 conductor per clamp	Rigid: Solid/Stranded	0.5 ... 6 mm ²	26 ... 10 AWG	Rail	TH 35-7.5, TH 35-15
	Flexible without ferrule	0.5 ... 4 mm ²	26 ... 12 AWG	Wire stripping length	12.5 mm 0.492 in
	Flexible with non insulated ferrule	0.5 ... 4 mm ²	26 ... 12 AWG	Tool (for flexible conductor without ferrule)	Flat screwdriver Ø 3.5 mm Ø 0.138 in
	Flexible with insulated ferrule	0.5 ... 4 mm ²	26 ... 12 AWG		
Rated cross section		4 mm ²	10 AWG		
Rated short-time withstand current (1s)		480 A	636 A		
Protection		IP20	NEMA 1		
Explosive atmosphere classification		IM2 II 2 GD Ex eb I/II C - Class I, Zone 1, AEx e II, Ex e II U			

The connecting capacity data for one Rigid: Solid/Stranded, or one Flexible conductor (when applicable) is a mandatory information required by IEC, UL and CSA standards (Copper conductors). All other data are provided as supplementary information only. For more details, please consult our CB, UL or CSA certificates and technical datasheet available on <http://www.TE.com>



Accessories

Description	Color	Type	Part Number	Pkg qty	Weight (1 pce) g
1 End stops	Dark grey	BAZ1	1SNK900002R0000	50	5.30
2 End sections	Dark grey	EK2.5	1SNK705910R0000	20	1.80
3 Circuit separators	Dark grey	CS-R2	1SNK900106R0000	20	3.80
4 Terminal block markers	White	MG-CPM 13 41791	1SNB041791R0612	1680	0.27
		MC612	1SNK150000R0000	22	10.00
		MC612PA	1SNK159999R0000	20	11.00
Universal wire markers holder	Grey	UMH	1SNK900611R0000	10	0.20

Complete list of accessories is indicated in the terminal block datasheet including end stops. Some accessories such as jumper bars may modify the terminal block's ratings. Complete information available in the accessories section of the catalog.

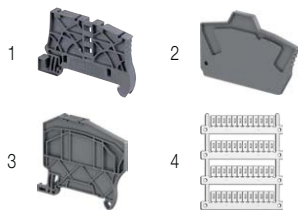

Technical data valid for copper conductors only.

ZK4-PE-3P PI-Spring terminal blocks

Ground with 3 connections - 6 mm 0.236 in spacing



ZK4-PE-3P

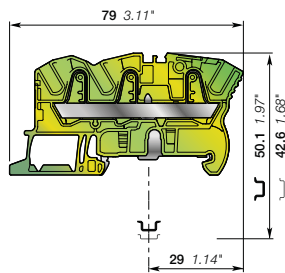

6 mm 0.236 in spacing

Description

Improve the safety of your installation in the event of a short-circuit thanks to our screwless rail contact:

- Rail contact non operator dependent,
- Performances above the requirements of the IEC 60947-7-2 terminal block standard,
- Secured snap on or off the rail,
- Profile aligned with ZK4-3P.

Ordering details

Description	Color	Type	Part Number	Pkg qty	Weight (1 pce) g
Ground 3 connections	Green-yellow	ZK4-PE-3P	1SNK706151R0000	20	15.70

Main technical data

Connecting capacity		IEC	UL - CSA	Rail	TH 35-7.5, TH 35-15
1 conductor per clamp	Rigid: Solid/Stranded	0.5 ... 6 mm ²	26 ... 10 AWG	Wire stripping length	12.5 mm 0.492 in
	Flexible without ferrule	0.5 ... 4 mm ²	26 ... 12 AWG		
	Flexible with non insulated ferrule	0.5 ... 4 mm ²	26 ... 12 AWG		
	Flexible with insulated ferrule	0.5 ... 4 mm ²	26 ... 12 AWG		
Rated cross section		4 mm ²	10 AWG	Tool (for flexible conductor without ferrule)	Flat screwdriver Ø 3.5 mm Ø 0.138 in
Rated short-time withstand current (1s)		480 A	636 A		
Protection		IP20	NEMA 1		
Explosive atmosphere classification		IM2 II 2 GD Ex eb I/IC/IIIC - Class I, Zone 1, AEx e II, Ex e II U			

The connecting capacity data for one Rigid: Solid/Stranded, or one Flexible conductor (when applicable) is a mandatory information required by IEC, UL and CSA standards (Copper conductors). All other data are provided as supplementary information only. For more details, please consult our CB, UL or CSA certificates and technical datasheet available on <http://www.TE.com>

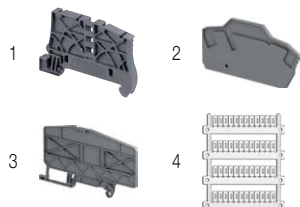

Accessories

Description	Color	Type	Part Number	Pkg qty	Weight (1 pce) g
1 End stops	Dark grey	BAZ1	1SNK900002R0000	50	5.30
2 End sections	Dark grey	EK2.5-3P	1SNK705911R0000	20	2.40
3 Circuit separators	Dark grey	CS-R3	1SNK900107R0000	20	6.40
4 Terminal block markers	White	MG-CPM 13 41791	1SNB041791R0612	1680	0.27
		MC612	1SNK150000R0000	22	10.00
		MC612PA	1SNK159999R0000	20	11.00
Universal wire markers holder	Grey	UMH	1SNK900611R0000	10	0.20

Complete list of accessories is indicated in the terminal block datasheet including end stops.

Some accessories such as jumper bars may modify the terminal block's ratings: Complete information available in the accessories section of the catalog.

Technical data valid for copper conductors only.

ZK4-PE-4P PI-Spring terminal blocks

Ground with 4 connections - 6 mm 0.236 in spacing



ZK4-PE-4P

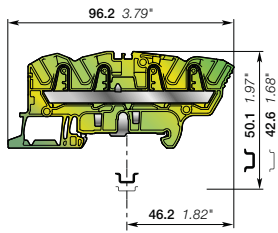

6 mm 0.236 in spacing

Description

Improve the safety of your installation in the event of a short-circuit thanks to our screwless rail contact:

- Rail contact non operator dependent,
- Performances above the requirements of the IEC 60947-7-2 terminal block standard,
- Secured snap on or off the rail,
- Profile aligned with ZK4-4P.

Ordering details

Description	Color	Type	Part Number	Pkg qty	Weight (1 pce) g
Ground 4 connections	Green-yellow	ZK4-PE-4P	1SNK706152R0000	20	18.40

Main technical data

Connecting capacity	IEC	UL - CSA	Mounting instructions		
1 conductor per clamp	Rigid: Solid/Stranded	0.5 ... 6 mm ²	26 ... 10 AWG	Rail	TH 35-7.5, TH 35-15
	Flexible without ferrule	0.5 ... 4 mm ²	26 ... 12 AWG	Wire stripping length	12.5 mm 0.492 in
	Flexible with non insulated ferrule	0.5 ... 4 mm ²	26 ... 12 AWG	Tool (for flexible conductor without ferrule)	Flat screwdriver Ø 3.5 mm Ø 0.138 in
	Flexible with insulated ferrule	0.5 ... 4 mm ²	26 ... 12 AWG		
Rated cross section		4 mm ²	10 AWG		
Rated short-time withstand current (1s)		480 A	636 A		
Protection		IP20	NEMA 1		
Explosive atmosphere classification		IM2 II 2 GD Ex eb I/II C - Class I, Zone 1, AEx e II, Ex e II U			

The connecting capacity data for one Rigid: Solid/Stranded, or one Flexible conductor (when applicable) is a mandatory information required by IEC, UL and CSA standards (Copper conductors). All other data are provided as supplementary information only. For more details, please consult our CB, UL or CSA certificates and technical datasheet available on <http://www.TE.com>

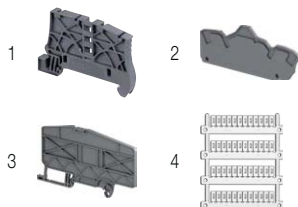

Accessories

Description	Color	Type	Part Number	Pkg qty	Weight (1 pce) g
1 End stops	Dark grey	BAZ1	1SNK900002R0000	50	5.30
2 End sections	Dark grey	EK2.5-4P	1SNK705912R0000	20	2.70
3 Circuit separators	Dark grey	CS-R3	1SNK900107R0000	20	6.40
4 Terminal block markers	White	MG-CPM 13 41791	1SNB041791R0612	1680	0.27
		MC612	1SNK150000R0000	22	10.00
		MC612PA	1SNK159999R0000	20	11.00
Universal wire markers holder	Grey	UMH	1SNK900611R0000	10	0.20

Complete list of accessories is indicated in the terminal block datasheet including end stops. Some accessories such as jumper bars may modify the terminal block's ratings. Complete information available in the accessories section of the catalog.

Technical data valid for copper conductors only.

ZK6-PE PI-Spring terminal blocks

Ground - 8 mm 0.315 in spacing



ZK6-PE

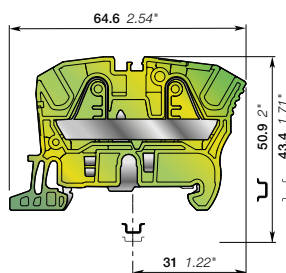

8 mm 0.315 in spacing

Description

Improve the safety of your installation in the event of a short-circuit thanks to our screwless rail contact:

- Rail contact non operator dependent,
- Performances above the requirements of the IEC 60947-7-2 terminal block standard,
- Secured snap on or off the rail,
- Profile aligned with ZK6.

Ordering details

Description	Color	Type	Part Number	Pkg qty	Weight (1 pce) g
Ground 2 connections	Green-yellow	ZK6-PE	1SNK708150R0000	20	20.30

Main technical data

Connecting capacity		IEC	UL - CSA	Mounting instructions	
1 conductor per clamp	Rigid: Solid/Stranded	0.5 ... 10 mm²	24 ... 8 AWG	Rail	TH 35-7.5, TH 35-15
	Flexible without ferrule	0.5 ... 6 mm²		Wire stripping length	12.5 mm 0.492 in
	Flexible with non insulated ferrule	0.5 ... 6 mm²	24 ... 10 AWG		
	Flexible with insulated ferrule	0.5 ... 6 mm²	24 ... 10 AWG		
Rated cross section		6 mm²	8 AWG	Tool (for flexible conductor without ferrule)	Flat screwdriver Ø 3.5 mm Ø 0.138 in
Rated short-time withstand current (1s)		720 A	1008 A		
Protection		IP20	NEMA 1		
Explosive atmosphere classification		IM2 II 2 GD Ex eb I/IC/IIIC - Class I, Zone 1, AEx e II, Ex e II U			

The connecting capacity data for one Rigid: Solid/Stranded, or one Flexible conductor (when applicable) is a mandatory information required by IEC, UL and CSA standards (Copper conductors). All other data are provided as supplementary information only. For more details, please consult our CB, UL or CSA certificates and technical datasheet available on <http://www.TE.com>

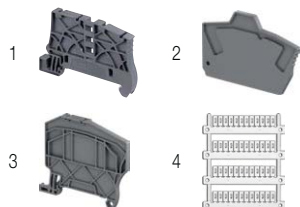

Accessories

Description	Color	Type	Part Number	Pkg qty	Weight (1 pce) g
1 End stops	Dark grey	BAZ1	1SNK900002R0000	50	5.30
2 End sections	Dark grey	EK2.5	1SNK705910R0000	20	1.80
3 Circuit separators	Dark grey	CS-R2	1SNK900106R0000	20	3.80
4 Terminal block markers	White	MG-CPM 13 41791	1SNB041791R0612	1680	0.27
		MC812	1SNK160000R0000	22	10.00
		MC812PA	1SNK169999R0000	20	14.00
Universal wire markers holder	Grey	UMH	1SNK900611R0000	10	0.20

Complete list of accessories is indicated in the terminal block datasheet including end stops. Some accessories such as jumper bars may modify the terminal block's ratings: Complete information available in the accessories section of the catalog.

Technical data valid for copper conductors only.

ZK6-PE-3P PI-Spring terminal blocks

Ground with 3 connections - 8 mm 0.315 in spacing



ZK6-PE-3P

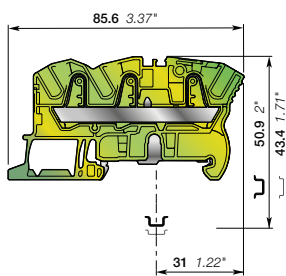

8 mm 0.315 in spacing

Description

Improve the safety of your installation in the event of a short-circuit thanks to our screwless rail contact:

- Rail contact non operator dependent,
- Performances above the requirements of the IEC 60947-7-2 terminal block standard,
- Secured snap on or off the rail,
- Profile aligned with ZK6-3P.

Ordering details

Description	Color	Type	Part Number	Pkg qty	Weight (1 pce) g
Ground 3 connections	Green-yellow	ZK6-PE-3P	1SNK708151R0000	20	21.50

Main technical data

Connecting capacity	IEC	UL - CSA	Rail	Wire stripping length	Tool (for flexible conductor without ferrule)
1 conductor per clamp	Rigid: Solid/Stranded	0.5 ... 10 mm ²	24 ... 8 AWG	12.5 mm 0.492 in	Flat screwdriver Ø 3.5 mm Ø 0.138 in
	Flexible without ferrule	0.5 ... 6 mm ²	24 ... 10 AWG		
	Flexible with non insulated ferrule	0.5 ... 6 mm ²	24 ... 10 AWG		
	Flexible with insulated ferrule	0.5 ... 6 mm ²	24 ... 10 AWG		
Rated cross section	6 mm ²	8 AWG			
Rated short-time withstand current (1s)	720 A	1008 A			
Protection	IP20	NEMA 1			
Explosive atmosphere classification	IM2 II 2 GD Ex eb I/IC/IIC - Class I, Zone 1, AEx e II, Ex e II U				

The connecting capacity data for one Rigid: Solid/Stranded, or one Flexible conductor (when applicable) is a mandatory information required by IEC, UL and CSA standards (Copper conductors). All other data are provided as supplementary information only. For more details, please consult our CB, UL or CSA certificates and technical datasheet available on <http://www.TE.com>

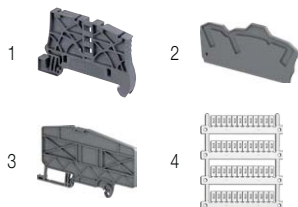

Accessories

Description	Color	Type	Part Number	Pkg qty	Weight (1 pce) g
1 End stops	Dark grey	BAZ1	1SNK900002R0000	50	5.30
2 End sections	Dark grey	EK6-3P	1SNK708911R0000	20	2.80
3 Circuit separators	Dark grey	CS-R3	1SNK900107R0000	20	6.40
4 Terminal block markers	White	MG-CPM 13 41791	1SNB041791R0612	1680	0.27
		MC812	1SNK160000R0000	22	10.00
		MC812PA	1SNK169999R0000	20	14.00
Universal wire markers holder	Grey	UMH	1SNK900611R0000	10	0.20

Complete list of accessories is indicated in the terminal block datasheet including end stops. Some accessories such as jumper bars may modify the terminal block's ratings. Complete information available in the accessories section of the catalog.

Technical data valid for copper conductors only.

ZK10-PE PI-Spring terminal blocks

Ground - 10 mm 0.394 in spacing



ZK10-PE

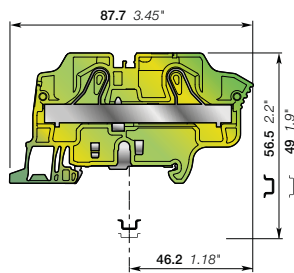

10 mm 0.394 in spacing

Description

Improve the safety of your installation in the event of a short-circuit thanks to our screwless rail contact:

- Rail contact non operator dependent,
- Performances above the requirements of the IEC 60947-7-2 terminal block standard,
- Secured snap on or off the rail,
- Profile aligned with ZK10.

Ordering details

Description	Color	Type	Part Number	Pkg qty	Weight (1 pce) g
Ground 2 connections	Green-yellow	ZK10-PE	1SNK710150R0000	20	36.20

Main technical data

Connecting capacity	IEC	UL - CSA	Mounting instructions
1 conductor per clamp			
Rigid: Solid/Stranded	0.5 ... 16 mm ²	20 ... 6 AWG	Rail
Flexible without ferrule	0.5 ... 10 mm ²	20 ... 8 AWG	Wire stripping length
Flexible with non insulated ferrule	0.5 ... 10 mm ²	20 ... 8 AWG	
Flexible with insulated ferrule	0.5 ... 10 mm ²	20 ... 8 AWG	Tool (for flexible conductor without ferrule)
Rated cross section	10 mm ²	6 AWG	
Rated short-time withstand current (1s)	1200 A	1596 A	
Protection	IP20	NEMA 1	
Explosive atmosphere classification	IM2 II 2 GD Ex eb I/IC/IIIC - Class I, Zone 1, AEx e II, Ex e II U		

The connecting capacity data for one Rigid: Solid/Stranded, or one Flexible conductor (when applicable) is a mandatory information required by IEC, UL and CSA standards (Copper conductors). All other data are provided as supplementary information only. For more details, please consult our CB, UL or CSA certificates and technical datasheet available on <http://www.TE.com>



Accessories

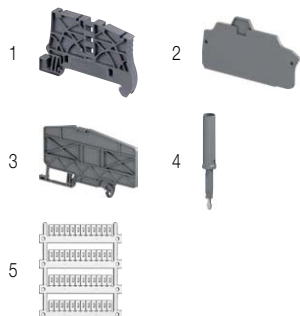

Description	Color	Type	Part Number	Pkg qty	Weight (1 pce) g
1 End stops	Dark grey	BAZ1	1SNK900002R0000	50	5.30
2 End sections	Dark grey	EK10	1SNK710910R0000	20	3.30
3 Circuit separators	Dark grey	CS-R3	1SNK900107R0000	20	6.40
4 Test adapters	Dark grey	TP2	1SNK900203R0000	20	1.70
		TP4	1SNK900205R0000	20	2.40
5 Terminal block markers	White	MG-CPM 13 41791	1SNB041791R0612	1680	0.27
		MC812	1SNK160000R0000	22	10.00
		MC812PA	1SNK169999R0000	20	14.00
	Grey	UMH	1SNK900611R0000	10	0.20

Complete list of accessories is indicated in the terminal block datasheet including end stops. Some accessories such as jumper bars may modify the terminal block's ratings: Complete information available in the accessories section of the catalog.

Technical data valid for copper conductors only.

ZK10-PE-3P PI-Spring terminal blocks

Ground with 3 connections - 10 mm 0.394 in spacing



ZK10-PE-3P

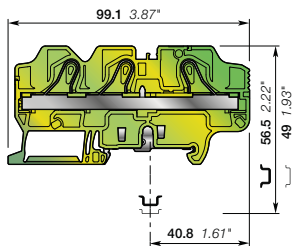

10 mm 0.394 in spacing

Description

Improve the safety of your installation in the event of a short-circuit thanks to our screwless rail contact:

- Rail contact non operator dependent,
- Performances above the requirements of the IEC 60947-7-2 standard,
- Secured snap on or off the rail,
- Profile aligned with ZK10-3P.

Ordering details

Description	Color	Type	Part Number	Pkg qty	Weight (1 pce)
Ground 3 connections	Green-yellow	ZK10-PE-3P	1SNK710151R0000	20	43.3 g

Main technical data

Connecting capacity	IEC	UL - CSA	Rail	Wire stripping length	Tool (for flexible conductor without ferrule)
1 conductor per clamp	Rigid: Solid/Stranded	0.5 ... 16 mm ²	20 ... 6 AWG	15 mm 0.591 in	Flat screwdriver Ø 4 mm Ø 0.157 in
	Flexible without ferrule	0.5 ... 10 mm ²	20 ... 8 AWG		
	Flexible with non insulated ferrule	0.5 ... 10 mm ²	20 ... 8 AWG		
	Flexible with insulated ferrule	0.5 ... 10 mm ²	20 ... 8 AWG		
Rated cross section	10 mm ²	6 AWG			
Rated short-time withstand current (1s)	1200 A	1596 A			
Protection	IP20	NEMA 1			
Explosive atmosphere classification	IM2 II 2 GD Ex eb I/II/III C				

The connecting capacity data for one Rigid: Solid/Stranded, or one Flexible conductor (when applicable) is a mandatory information required by IEC, UL and CSA standards (Copper conductors). All other data are provided as supplementary information only. For more details, please consult our CB, UL or CSA certificates and technical datasheet available on <http://www.TE.com>



Accessories

Description	Color	Type	Part Number	Pkg qty	Weight (1 pce)
1 End stops	Dark grey	BAZ1	1SNK900002R0000	50	5.30
2 End sections	Dark grey	EK10-3P	1SNK710911R0000	20	4.5
3 Test adapters	Dark grey	TP2	1SNK900203R0000	20	1.70
		TP4	1SNK900205R0000	20	2.40
4 Terminal block markers	White	MG-CPM 13 41791	1SNB041791R0612	1680	0.27
		MC812	1SNK160000R0000	22	10.00
		MC812PA	1SNK169999R0000	20	14.00
	Universal wire markers holder	Grey	UMH	1SNK900611R0000	10

Complete list of accessories is indicated in the terminal block datasheet including end stops.

Some accessories such as jumper bars may modify the terminal block's ratings: Complete information available in the accessories section of the catalog.

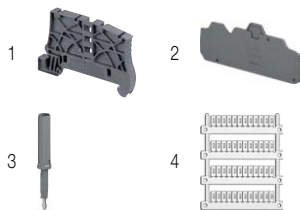

Technical data valid for copper conductors only.

ZK16-PE PI-Spring terminal blocks

Ground - 12 mm 0.472 in spacing



16 mm²
4 AWG



1SNK16208AV0014

ZK16-PE

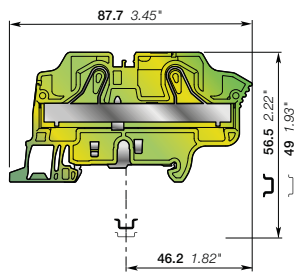

12 mm 0.472 in spacing

Description

Improve the safety of your installation in the event of a short-circuit thanks to our screwless rail contact:

- Rail contact non operator dependent,
- Performances above the requirements of the IEC 60947-7-2 terminal block standard,
- Secured snap on or off the rail,
- Profile aligned with ZK16.

Ordering details

Description	Color	Type	Part Number	Pkg qty	Weight (1 pce) g
Ground 2 connections	Green-yellow	ZK16-PE	1SNK712150R0000	20	47.00

Main technical data

Connecting capacity		IEC	UL - CSA	Mounting instructions	
1 conductor per clamp	Rigid: Solid/Stranded	0.5 ... 25 mm ²	20 ... 4 AWG	Rail	TH 35-7.5, TH 35-15
	Flexible without ferrule	0.5 ... 16 mm ²	20 ... 6 AWG	Wire stripping length	15 mm 0.591 in
	Flexible with non insulated ferrule	0.5 ... 16 mm ²	20 ... 6 AWG		
	Flexible with insulated ferrule	0.5 ... 16 mm ²	20 ... 6 AWG	Tool (for flexible conductor without ferrule)	Flat screwdriver Ø 4 mm Ø 0.157 in
Rated cross section		16 mm ²	4 AWG		
Rated short-time withstand current (1s)		1920 A	2544 A		
Protection		IP20	NEMA 1		
Explosive atmosphere classification		IM2 II 2 GD Ex eb I/IC/IIIC - Class I, Zone 1, AEx e II, Ex e II U			

The connecting capacity data for one Rigid: Solid/Stranded, or one Flexible conductor (when applicable) is a mandatory information required by IEC, UL and CSA standards (Copper conductors). All other data are provided as supplementary information only. For more details, please consult our CB, UL or CSA certificates and technical datasheet available on <http://www.TE.com>



Accessories

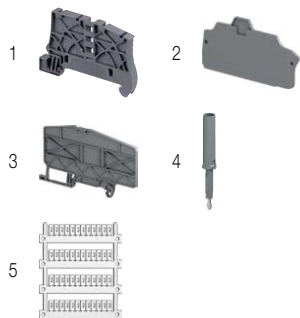

Description	Color	Type	Part Number	Pkg qty	Weight (1 pce) g
1 End stops	Dark grey	BAZ1	1SNK900002R0000	50	5.30
2 End sections	Dark grey	EK10	1SNK710910R0000	20	3.30
3 Circuit separators	Dark grey	CS-R3	1SNK900107R0000	20	6.40
4 Test adapters	Dark grey	TP2	1SNK900203R0000	20	1.70
		TP4	1SNK900205R0000	20	2.40
5 Terminal block markers	White	MG-CPM 13 41791	1SNB041791R0612	1680	0.27
		MC812	1SNK160000R0000	22	10.00
		MC812PA	1SNK169999R0000	20	14.00
		Universal wire markers holder	Grey	UMH	1SNK900611R0000

Complete list of accessories is indicated in the terminal block datasheet including end stops. Some accessories such as jumper bars may modify the terminal block's ratings: Complete information available in the accessories section of the catalog.

Technical data valid for copper conductors only.

ZK16-PE-3P PI-Spring terminal blocks

Ground with 3 connections - 12 mm 0.472 in spacing



ZK16-PE-3P

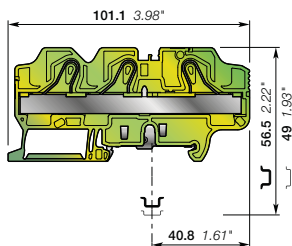

12 mm 0.472 in spacing

Description

Improve the safety of your installation in the event of a short-circuit thanks to our screwless rail contact:

- Rail contact non operator dependent,
- Performances above the requirements of the IEC 60947-7-2 standard,
- Secured snap on or off the rail,
- Profile aligned with ZK16-3P.

Ordering details

Description	Color	Type	Part Number	Pkg qty	Weight (1 pce) g
Ground 3 connections	Green-yellow	ZK16-PE-3P	1SNK712151R0000	20	56.65

Main technical data

Connecting capacity	IEC	UL - CSA	Rail	Wire stripping length	TH 35-7.5, TH 35-15
1 conductor per clamp	Rigid: Solid/Stranded	0.5 ... 25 mm ²	20 ... 4 AWG		15 mm
	Flexible without ferrule	0.5 ... 16 mm ²	20 ... 6 AWG		0.591 in
	Flexible with non insulated ferrule	0.5 ... 16 mm ²	20 ... 6 AWG		
	Flexible with insulated ferrule	0.5 ... 16 mm ²	20 ... 6 AWG		
Rated cross section	16 mm ²	4 AWG	Tool (for flexible conductor without ferrule)	Flat screwdriver	Ø 4 mm
Rated short-time withstand current (1s)	1920 A	2544 A			Ø 0.157 in
Protection	IP20	NEMA 1			
Explosive atmosphere classification	IM2 II 2 GD Ex eb I/II/III C				

The connecting capacity data for one Rigid: Solid/Stranded, or one Flexible conductor (when applicable) is a mandatory information required by IEC, UL and CSA standards (Copper conductors). All other data are provided as supplementary information only. For more details, please consult our CB, UL or CSA certificates and technical datasheet available on <http://www.TE.com>

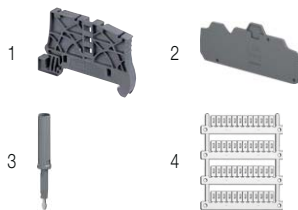

Accessories

Description	Color	Type	Part Number	Pkg qty	Weight (1 pce) g
1 End stops	Dark grey	BAZ1	1SNK900002R0000	50	5.30
2 End sections	Dark grey	EK10-3P	1SNK710911R0000	20	4.5
3 Test adapters	Dark grey	TP2	1SNK900203R0000	20	1.70
		TP4	1SNK900205R0000	20	2.40
4 Terminal block markers	White	MG-CPM 13 41791	1SNB041791R0612	1680	0.27
		MC812	1SNK160000R0000	22	10.00
		MC812PA	1SNK169999R0000	20	14.00
	Universal wire markers holder	Grey	UMH	1SNK900611R0000	10

Complete list of accessories is indicated in the terminal block datasheet including end stops.

Some accessories such as jumper bars may modify the terminal block's ratings: Complete information available in the accessories section of the catalog.

Technical data valid for copper conductors only.

ZK2.5-S PI-Spring terminal blocks

Disconnect with blade - with test sockets - 5.2 mm 0.205 in spacing

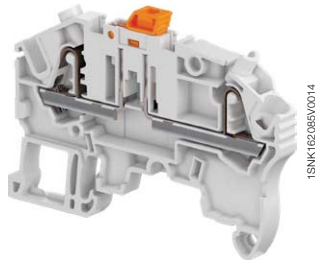

ZK2.5-S

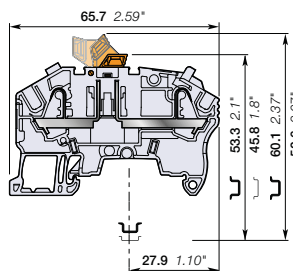

5.2 mm 0.205 in spacing

Description

Combine high performance with compact dimensions: 630 V IEC 300 V UL.

Secure the current measurement:

- for currents below 50 mA, thanks to 2 built in test points DIA 2 mm 0.079 in,
- for currents up to 16 A, by using the TP4 test adapter inserted into the jumper channels.

Ordering details

Description	Color	Type	Part Number	Pkg qty	Weight (1 pce) g
Disconnect with 2 test sockets DIA 2 mm 0.079 in	Grey	ZK2.5-S	1SNK705310R0000	50	8.10
	Blue	ZK2.5-S-BL	1SNK705320R0000	50	8.10
	Orange	ZK2.5-S-OR	1SNK705330R0000	50	8.10

Main technical data

Connecting capacity	IEC	UL - CSA	Mounting instructions
1 conductor per clamp	Rigid: Solid/Stranded Flexible without ferrule Flexible with non insulated ferrule Flexible with insulated ferrule	0.2 ... 4 mm² 0.22 ... 2.5 mm² 0.22 ... 2.5 mm² 0.22 ... 2.5 mm²	26 ... 12 AWG 26 ... 14 AWG 26 ... 14 AWG
2 conductors per clamp	Flexible with twin ferrule	0.22 ... 0.5 mm²	26 ... 20 AWG
Rated current / Rated cross section	20 A / 2.5 mm²	20 A / 12 AWG	
Rated short-time withstand current (1s)	300 A	396 A	
Rated voltage	630 V	300 V	
Impulse withstand voltage	6000 V		
Protection	IP20	NEMA 1	

Recommendation for best usage: in horizontal assemblies, disconnect terminal blocks should be mounted with fixed foot on top (power side) so that the disconnect knife does not partially close through gravity. Furthermore, as specified per IEC 60947-7-1, disconnect terminal blocks are intended to be used for temporary disconnection at zero potential and at no load.

The connecting capacity data for one Rigid: Solid/Stranded, or one Flexible conductor (when applicable) is a mandatory information required by IEC, UL and CSA standards (Copper conductors). All other data are provided as supplementary information only. For more details, please consult our CB, UL or CSA certificates and technical datasheet available on <http://www.TE.com>

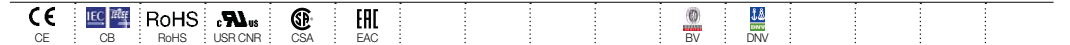

Accessories

Description	Color	Type	Part Number	Pkg qty	Weight (1 pce) g	
1 End stops	Dark grey	BAZ1	1SNK900002R0000	50	5.30	
2 End sections	Dark grey	EK2.5-3P	1SNK705911R0000	20	2.40	
3 Jumper bars	Orange	2 poles 32 A (IEC)	JB5-2	1SNK905302R0000	50	1.30
		3 poles 32 A (IEC)	JB5-3	1SNK905303R0000	50	2.00
		4 poles 32 A (IEC)	JB5-4	1SNK905304R0000	50	2.70
		5 poles 32 A (IEC)	JB5-5	1SNK905305R0000	50	3.50
		10 poles 32 A (IEC)	JB5-10	1SNK905310R0000	30	7.10
		50 poles 32 A (IEC)	JB5-50	1SNK905350R0000	10	36.00
4 Circuit separators	Dark grey	CS-R3	1SNK900107R0000	20	6.40	
5 Test adapters	Dark grey	For test plugs DIA 2 mm 0.079 in	TP2	1SNK900203R0000	20	1.70
		For test plugs DIA 4 mm 0.157 in	TP4	1SNK900205R0000	20	2.40
6 Test connectors	Dark grey	5.2 mm 0.205 in spacing	TC5	1SNK900200R0000	10	5.20
		End module, 5.2 mm 0.205 in	TC5-R1	1SNK900201R0000	10	5.20
7 Shield connectors		SHBP	1SNK900601R0000	20	4.10	
8 Terminal block markers	White	Blank marker	MG-CPM 13 41790	1960	0.23	
		Blank card	MC512	1SNK140000R0000	22	9.00
			MC512PA	1SNK149999R0000	20	10.00
		Universal wire markers holder	Grey	UMH	1SNK900611R0000	10

Complete list of accessories is indicated in the terminal block datasheet including end stops.

Some accessories such as jumper bars may modify the terminal block's ratings: Complete information available in the accessories section of the catalog.

Technical data valid for copper conductors only.

ZK2.5-S-4P PI-Spring terminal blocks

Disconnect with blade - with test socket - 5.2 mm 0.205 in spacing



ZK2.5-S-4P

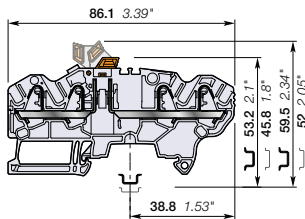

5.2 mm 0.205 in spacing

Description

- Combine high performances with compact dimensions: 630 V IEC 300 V UL,
- Simplify the measurement with 1 built in test point DIA 2 mm 0.079 in (for current below 50mA) and TP... test adapter inserted into one jumper channel,
- Clear marking visibility with SNK top marking location 20% enlarged.

Ordering details

Description	Color	Type	Part Number	Pkg qty	Weight (1 pce) g
Disconnect with 1 test socket DIA 2 mm 0.079 in	Grey	ZK2.5-S-4P	1SNK705312R0000	50	11.14
	Blue	ZK2.5-S-4P-BL	1SNK705321R0000	50	11.14
	Orange	ZK2.5-S-4P-OR	1SNK705331R0000	50	11.14

Main technical data

Connecting capacity	IEC	UL - CSA	Mounting instructions		
1 conductor per clamp	Rigid: Solid/Stranded	0.2 ... 4 mm ²	26 ... 12 AWG	Rail	TH 35-7.5, TH 35-15
	Flexible without ferrule	0.22 ... 2.5 mm ²	26 ... 14 AWG	Wire stripping length	11 mm 0.433 in
	Flexible with non insulated ferrule	0.22 ... 2.5 mm ²	26 ... 14 AWG	Tool (for flexible conductor without ferrule)	Flat screwdriver Ø 3.5 mm Ø 0.138 in
	Flexible with insulated ferrule	0.22 ... 2.5 mm ²	26 ... 14 AWG		
2 conductors per clamp	Flexible with twin ferrule	0.22 ... 0.5 mm ²	26 ... 20 AWG		
Rated current / Rated cross section		20 A / 2.5 mm ²	20 A / 12 AWG		
Rated short-time withstand current (1s)		300 A			
Short Circuit Current Rating (with specific conditions)					
Rated voltage		630 V	300 V		
Impulse withstand voltage		6000 V			
Protection		IP20	NEMA 1		

Recommendation for best usage: in horizontal assemblies, disconnect terminal blocks should be mounted with fixed foot on top (power side) so that the disconnect knife does not partially close through gravity. Furthermore, as specified per IEC 60947-7-1, disconnect terminal blocks are intended to be used for temporary disconnection at zero potential and at no load.

The connecting capacity data for one Rigid: Solid/Stranded, or one Flexible conductor (when applicable) is a mandatory information required by IEC, UL and CSA standards (Copper conductors). All other data are provided as supplementary information only. For more details, please consult our CB, UL or CSA certificates and technical datasheet available on <http://www.TE.com>

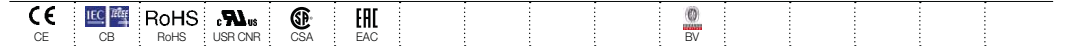

Accessories



Description	Color	Type	Part Number	Pkg qty	Weight (1 pce) g	
1 End stops	Dark grey	BAZ1	1SNK900002R0000	50	5.30	
2 End sections	Dark grey	EK2.5-S-4P	1SNK705913R0000	20	2.94	
3 Jumper bars	Orange	2 poles	JB5-2	1SNK905302R0000	50	1.30
		3 poles	JB5-3	1SNK905303R0000	50	2.00
		4 poles	JB5-4	1SNK905304R0000	50	2.70
		5 poles	JB5-5	1SNK905305R0000	50	3.50
		10 poles	JB5-10	1SNK905310R0000	30	7.10
		50 poles	JB5-50	1SNK905350R0000	10	36.00
4 Circuit separators	Dark grey	CS-R3	1SNK900107R0000	20	6.40	
5 Test adapters	Dark grey	For test plugs DIA 2 mm 0.079 in	TP2	1SNK900203R0000	20	1.70
		For test plugs DIA 4 mm 0.157 in	TP4	1SNK900205R0000	20	2.40
6 Test connectors	Dark grey	5.2 mm 0.205 in spacing	TC5	1SNK900200R0000	10	5.20
		End module, 5.2 mm 0.205 in	TC5-R1	1SNK900201R0000	10	5.20
		Blank marker	White	MG-CPM 13 41790	1960	0.23
7 Terminal block markers	Grey	Blank card	MC512	1SNK140000R0000	22	9.00
			MC512PA	1SNK149999R0000	20	10.00
		Universal wire markers holder	UMH	1SNK900611R0000	10	0.20

Complete list of accessories is indicated in the terminal block datasheet including end stops.

Some accessories such as jumper bars may modify the terminal block's ratings: Complete information available in the accessories section of the catalog.

Technical data valid for copper conductors only.

ZK2.5-S-R1 PI-Spring terminal blocks

Disconnect with blade - 6 mm 0.236 in spacing

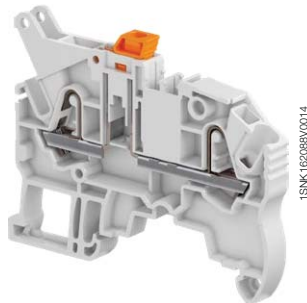

ZK2.5-S-R1

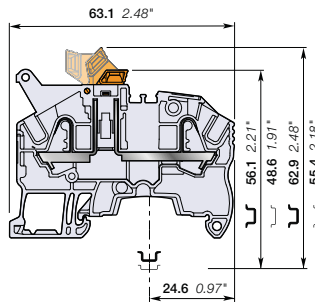

6 mm 0.236 in spacing

Description

Simplify the distribution of circuits in marshalling cabinets thanks to our disconnect terminal blocks with the same profile as ZK2.5-SF fuse.

Ordering details

Description	Color	Type	Part Number	Pkg qty	Weight (1 pce) g
Disconnect Profile aligned with ZK2.5-SF	Grey <input type="checkbox"/>	ZK2.5-S-R1	1SNK706310R0000	50	8.90

Main technical data

Connecting capacity	IEC	UL - CSA	Mounting instructions
1 conductor per clamp	Rigid: Solid/Stranded Flexible without ferrule Flexible with non insulated ferrule Flexible with insulated ferrule	0.2 ... 4 mm² 0.22 ... 2.5 mm² 0.22 ... 2.5 mm² 0.22 ... 2.5 mm²	26 ... 12 AWG 26 ... 14 AWG 26 ... 14 AWG 26 ... 14 AWG
2 conductors per clamp	Flexible with twin ferrule	0.22 ... 0.5 mm²	26 ... 20 AWG
Rated current / Rated cross section	20 A / 2.5 mm²	20 A / 12 AWG	
Rated short-time withstand current (1s)	300 A	396 A	
Rated voltage	630 V	300 V	
Impulse withstand voltage	6000 V		
Protection	IP20	NEMA 1	

Recommendation for best usage: in horizontal assemblies, disconnect terminal blocks should be mounted with fixed foot on top (power side) so that the disconnect knife does not partially close through gravity. Furthermore, as specified per IEC 60947-7-1, disconnect terminal blocks are intended to be used for temporary disconnection at zero potential and at no load.

The connecting capacity data for one Rigid: Solid/Stranded, or one Flexible conductor (when applicable) is a mandatory information required by IEC, UL and CSA standards (Copper conductors). All other data are provided as supplementary information only. For more details, please consult our CB, UL or CSA certificates and technical datasheet available on <http://www.TE.com>



Accessories

Description	Color	Type	Part Number	Pkg qty	Weight (1 pce) g
1 End stops	Dark grey <input type="checkbox"/>	BAZ1	1SNK900002R0000	50	5.30
2 End sections	Dark grey <input type="checkbox"/>	EK2.5-3P	1SNK705911R0000	20	2.40
3 Jumper bars	Orange <input type="checkbox"/>	JB6-2 JB6-3 JB6-4 JB6-5 JB6-10 JB6-50	1SNK906302R0000 1SNK906303R0000 1SNK906304R0000 1SNK906305R0000 1SNK906310R0000 1SNK906350R0000	50 50 50 50 20 10	1.30 2.10 2.90 3.60 7.40 38.10
4 Circuit separators	Dark grey <input type="checkbox"/>	CS-R3	1SNK900107R0000	20	6.40
5 Test adapters	Dark grey <input type="checkbox"/>	TP2 TP4	1SNK900203R0000 1SNK900205R0000	20 20	1.70 2.40
6 Test connectors	Dark grey <input type="checkbox"/>	TC5-R1	1SNK900201R0000	10	5.20
7 Spacers	Dark grey <input type="checkbox"/>	ES-TC6	1SNK900105R0000	10	0.80
8 Terminal block markers	White <input type="checkbox"/>	MG-CPM 13 41791 MC612 MC612PA Universal wire markers holder	1SNB041791R0612 1SNK150000R0000 1SNK159999R0000 1SNK900611R0000	1680 22 20 10	0.27 10.00 11.00 0.20

Complete list of accessories is indicated in the terminal block datasheet including end stops. Some accessories such as jumper bars may modify the terminal block's ratings. Complete information available in the accessories section of the catalog.

PI-Spring terminal blocks

Description	Color	Type	Part Number	Pkg qty	Weight (1 pce) g
Feed-through	Grey <input type="checkbox"/>	ZK4-3P	1SNK706011R0000	50	11.00
Fuse	Grey, dark grey <input type="checkbox"/>	ZK2.5-SF	1SNK706410R0000	50	16.20

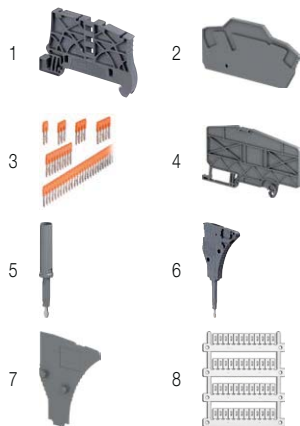

ZK4-3P

ZK2.5-SF

Technical data valid for copper conductors only.

ZK2.5-SP PI-Spring terminal blocks

Disconnect with plug - with test sockets - 5.2 mm 0.205 in spacing

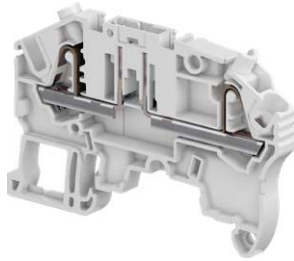

1SNK162039/0014

ZK2.5-SP

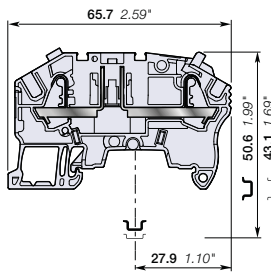

5.2 mm 0.205 in spacing

Description

The flexible solution for fitting the component of your choice in series with our quick-fitting PG5 component holder plug:
 – compatible with components of 8.8 x 3.2 mm 0.346 x 0.125 in, such as resistors, diodes or mini axial fuses.

Ordering details

Description	Color	Type	Part Number	Pkg qty	Weight (1 pce) g
Disconnect with 2 test sockets DIA 2 mm 0.079 in	Grey	ZK2.5-SP	1SNK705311R0000	50	11.50

Main technical data

Connecting capacity		IEC	UL - CSA	Mounting instructions	
1 conductor per clamp	Rigid: Solid/Stranded	0.2 ... 4 mm ²	26 ... 12 AWG	Rail	TH 35-7.5, TH 35-15
	Flexible without ferrule	0.22 ... 2.5 mm ²	26 ... 14 AWG	Wire stripping length	11 mm 0.433 in
	Flexible with non insulated ferrule	0.22 ... 2.5 mm ²	26 ... 14 AWG		
	Flexible with insulated ferrule	0.22 ... 2.5 mm ²	26 ... 14 AWG		
2 conductors per clamp	Flexible with twin ferrule	0.22 ... 0.5 mm ²	26 ... 20 AWG	Tool (for flexible conductor without ferrule)	Flat screwdriver Ø 3.5 mm Ø 0.138 in
Rated current / Rated cross section		17 A / 2.5 mm ²	18 A / 12 AWG		
Rated short-time withstand current (1s)		300 A	396 A		
Rated voltage		630 V	300 V		
Impulse withstand voltage		6000 V			
Protection		IP20	NEMA 1		

The connecting capacity data for one Rigid: Solid/Stranded, or one Flexible conductor (when applicable) is a mandatory information required by IEC, UL and CSA standards (Copper conductors). All other data are provided as supplementary information only. For more details, please consult our CB, UL or CSA certificates and technical datasheet available on <http://www.TE.com>

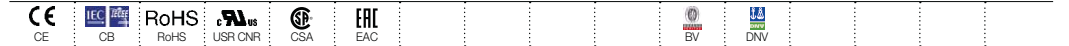

Accessories

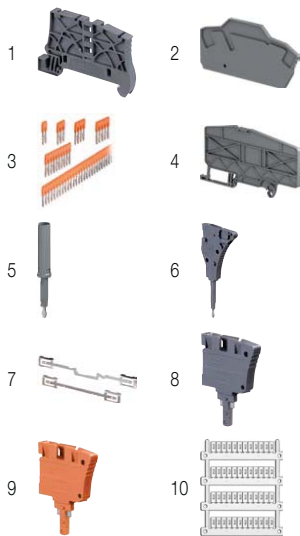

Description	Color	Type	Part Number	Pkg qty	Weight (1 pce) g	
1 End stops 5.2 mm 0.205 in	Dark grey	BAZ1	1SNK900002R0000	50	5.30	
2 End sections 2 mm 0.079 in	Dark grey	EK2.5-3P	1SNK705911R0000	20	2.40	
3 Jumper bars	Orange	2 poles 32 A (IEC)	JB5-2	1SNK905302R0000	50	1.30
		3 poles 32 A (IEC)	JB5-3	1SNK905303R0000	50	2.00
		4 poles 32 A (IEC)	JB5-4	1SNK905304R0000	50	2.70
		5 poles 32 A (IEC)	JB5-5	1SNK905305R0000	50	3.50
		10 poles 32 A (IEC)	JB5-10	1SNK905310R0000	30	7.10
		50 poles 32 A (IEC)	JB5-50	1SNK905350R0000	10	36.00
4 Circuit separators 3 mm 0.118 in	Dark grey	CS-R3	1SNK900107R0000	20	6.40	
5 Test adapters	Dark grey	For test plugs DIA 2 mm 0.079 in	TP2	1SNK900203R0000	20	1.70
		For test plugs DIA 4 mm 0.157 in	TP4	1SNK900205R0000	20	2.40
6 Test connectors 5.2 mm 0.205 in spacing	Dark grey	End module, 5.2 mm 0.205 in	TC5	1SNK900200R0000	10	5.20
			TC5-R1	1SNK900201R0000	10	5.20
7 Shield connectors		SHBP	1SNK900601R0000	20	4.10	
8 Component plugs Components in series with circuit	Dark grey	PG5	1SNK900401R0000	20	3.50	
9 Disconnect plugs Equipped with linking bar	Orange	PG5-R1	1SNK900402R0000	20	3.50	
10 Terminal block markers	White	Blank marker	MG-CPM 13 41790	1SNB041790R0512	1960	0.23
		Blank card	MC512	1SNK140000R0000	22	9.00
		Universal wire markers holder	UMH	1SNK149999R0000	20	10.00
	Grey		UMH	1SNK900611R0000	10	0.20

Complete list of accessories is indicated in the terminal block datasheet including end stops. Some accessories such as jumper bars may modify the terminal block's ratings. Complete information available in the accessories section of the catalog.

Technical data valid for copper conductors only.

ZK2.5-SP-4P PI-Spring terminal blocks

Disconnect with plug - with test socket - 5.2 mm 0.205 in spacing

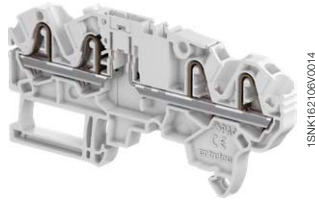

ZK2.5-SP-4P

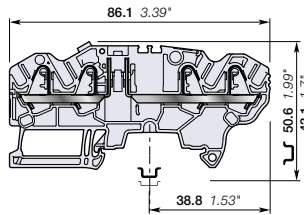

5.2 mm 0.205 in spacing

Description

The flexible solution for fitting the component of your choice in series with our quick-fitting PG5 component holder plug:

- compatible with components of 8.8 x 3.2 mm 0.346 x 0.125 in, such as resistors, diodes or mini axial fuses.

Ordering details

Description	Color	Type	Part Number	Pkg qty	Weight (1 pce) g
Disconnect with 1 test socket DIA 2 mm 0.079 in	Grey <input type="checkbox"/>	ZK2.5-SP-4P	1SNK705313R0000	50	10.67

Main technical data

Connecting capacity		IEC	UL - CSA	Mounting instructions	
1 conductor per clamp	Rigid: Solid/Stranded	0.2 ... 4 mm ²	26 ... 12 AWG	Rail	TH 35-7.5, TH 35-15
	Flexible without ferrule	0.22 ... 2.5 mm ²	26 ... 14 AWG	Wire stripping length	11 mm 0.433 in
	Flexible with non insulated ferrule	0.22 ... 2.5 mm ²	26 ... 14 AWG		
	Flexible with insulated ferrule	0.22 ... 2.5 mm ²	26 ... 14 AWG		
2 conductors per clamp	Flexible with twin ferrule	0.22 ... 0.5 mm ²	26 ... 20 AWG	Tool (for flexible conductor without ferrule)	Flat screwdriver Ø 3.5 mm Ø 0.138 in
Rated current / Rated cross section		17 A / 2.5 mm ²	18 A / 12 AWG		
Rated short-time withstand current (1s)		300 A			
Short Circuit Current Rating (with specific conditions)					
Rated voltage		630 V	300 V		
Impulse withstand voltage		6000 V			
Protection		IP20	NEMA 1		

The connecting capacity data for one Rigid: Solid/Stranded, or one Flexible conductor (when applicable) is a mandatory information required by IEC, UL and CSA standards (Copper conductors). All other data are provided as supplementary information only. For more details, please consult our CB, UL or CSA certificates and technical datasheet available on <http://www.TE.com>

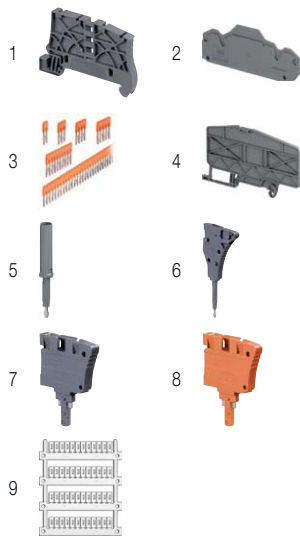
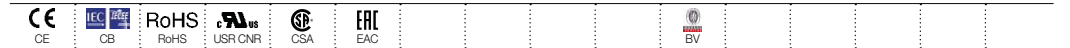

Accessories

Description	Color	Type	Part Number	Pkg qty	Weight (1 pce) g	
1 End stops	Dark grey <input type="checkbox"/>	BAZ1	1SNK900002R0000	50	5.30	
2 End sections	Dark grey <input type="checkbox"/>	EK2.5-S-4P	1SNK705913R0000	20	2.94	
3 Jumper bars	Orange <input type="checkbox"/>	2 poles	JB5-2	1SNK905302R0000	50	1.30
		3 poles	JB5-3	1SNK905303R0000	50	2.00
		4 poles	JB5-4	1SNK905304R0000	50	2.70
		5 poles	JB5-5	1SNK905305R0000	50	3.50
		10 poles	JB5-10	1SNK905310R0000	30	7.10
		50 poles	JB5-50	1SNK905350R0000	10	36.00
4 Circuit separators	Dark grey <input type="checkbox"/>	CS-R3	1SNK900107R0000	20	6.40	
5 Test adapters	Dark grey <input type="checkbox"/>	For test plugs DIA 2 mm 0.079 in	TP2	1SNK900203R0000	20	1.70
		For test plugs DIA 4 mm 0.157 in	TP4	1SNK900205R0000	20	2.40
6 Test connectors	Dark grey <input type="checkbox"/>	5.2 mm 0.205 in spacing	TC5	1SNK900200R0000	10	5.20
		End module, 5.2 mm 0.205 in	TC5-R1	1SNK900201R0000	10	5.20
7 Component plugs	Dark grey <input type="checkbox"/>	PG5	1SNK900401R0000	20	3.50	
8 Disconnect plugs	Orange <input type="checkbox"/>	PG5-R1	1SNK900402R0000	20	3.50	
9 Terminal block markers	White <input type="checkbox"/>	Blank marker	MG-CPM 13 41790	1SNB041790R0512	1960	0.23
		Blank card	MC512	1SNK140000R0000	22	9.00
	Grey <input type="checkbox"/>		MC512PA	1SNK149999R0000	20	10.00
		Universal wire markers holder	UMH	1SNK900611R0000	10	0.20

Complete list of accessories is indicated in the terminal block datasheet including end stops.

Some accessories such as jumper bars may modify the terminal block's ratings: Complete information available in the accessories section of the catalog.

Technical data valid for copper conductors only.

ZK2.5-SF PI-Spring terminal blocks

For 5x20 fuses - 6 mm 0.236 in spacing

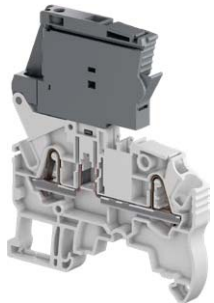

ZK2.5-SF

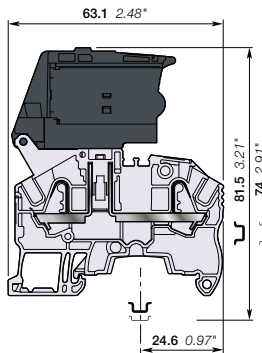

6 mm 0.236 in spacing

Description

Protect your circuits with 5x20 fuse terminal blocks compliant with IEC 60947-7-3 standard (fuse not supplied with the terminal blocks),

- Simplify the distribution thanks to the 2 jumper channels aligned with ZK4-3P feed-through and ZK2.5-S-R1 disconnect terminal blocks.

Ordering details

Description	Color	Type	Part Number	Pkg qty	Weight (1 pce)
Fuse	Grey, dark grey	ZK2.5-SF	1SNK706410R0000	50	16.20

Main technical data

Connecting capacity		IEC	UL - CSA	Mounting instructions	
1 conductor per clamp	Rigid: Solid/Stranded	0.2 ... 4 mm ²	26 ... 12 AWG	Rail	TH 35-7.5, TH 35-15
	Flexible without ferrule	0.22 ... 2.5 mm ²		Wire stripping length	11 mm 0.433 in
	Flexible with non insulated ferrule	0.22 ... 2.5 mm ²	26 ... 14 AWG		
	Flexible with insulated ferrule	0.22 ... 2.5 mm ²	26 ... 14 AWG		
2 conductors per clamp	Flexible with twin ferrule	0.22 ... 0.5 mm ²	26 ... 20 AWG	Tool (for flexible conductor without ferrule)	Flat screwdriver Ø 3.5 mm Ø 0.138 in
Rated current / Rated cross section		6.3 A / 2.5 mm ²	16 A / 12 AWG		
Rated short-time withstand current (1s)			396 A		
Rated voltage		500 V	300 V		
Impulse withstand voltage		6000 V			
Protection		IP20	NEMA 1		

The fuse holder must be first disconnected prior any fuse replacement. Mount your fuse safely without touching any active part: put the fuse into the hooks of the fuse holder shutter; at the closing of the shutter, the fuse is perfectly in place in the fuse holder.

Separate arrangement		Assembly composed of 1 fuse terminal block in between non fuse terminal blocks	Overload and short-circuit protection	2.5 W
			Exclusive short-circuit protection	4 W
Compound arrangement		Assembly composed of 5 fuse terminal blocks	Overload and short-circuit protection	1.6 W
			Exclusive short-circuit protection	4 W

The connecting capacity data for one Rigid: Solid/Stranded, or one Flexible conductor (when applicable) is a mandatory information required by IEC, UL and CSA standards (Copper conductors). All other data are provided as supplementary information only. For more details, please consult our CB, UL or CSA certificates and technical datasheet available on <http://www.TE.com>



Accessories

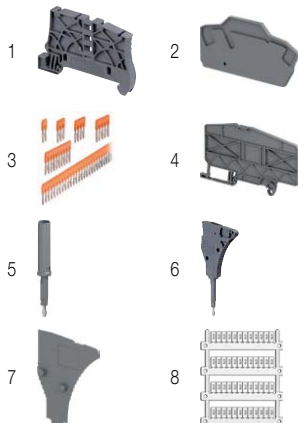

Description	Color	Type	Part Number	Pkg qty	Weight (1 pce)	
1 End stops	Dark grey	BAZ1	1SNK900002R0000	50	5.30	
2 End sections	Dark grey	EK2 5-3P	1SNK705911R0000	20	2.40	
3 Jumper bars	Orange	2 poles	JB6-2	1SNK906302R0000	50	1.30
		3 poles	JB6-3	1SNK906303R0000	50	2.10
		4 poles	JB6-4	1SNK906304R0000	50	2.90
		5 poles	JB6-5	1SNK906305R0000	50	3.60
		10 poles	JB6-10	1SNK906310R0000	20	7.40
		50 poles	JB6-50	1SNK906350R0000	10	38.10
4 Circuit separators	Dark grey	CS-R3	1SNK900107R0000	20	6.40	
5 Test adapters	Dark grey	For test plugs DIA 2 mm 0.079 in	TP2	1SNK900203R0000	20	1.70
		For test plugs DIA 4 mm 0.157 in	TP4	1SNK900205R0000	20	2.40
6 Test connectors	Dark grey	TC5-R1	1SNK900201R0000	10	5.20	
7 Spacers	Dark grey	ES-TC6	ES-TC6	1SNK900105R0000	10	0.80
			MG-CPM 13 41791	1SNB041791R0612	1680	0.27
			MC612	1SNK150000R0000	22	10.00
8 Terminal block markers	White	MC612PA	MC612PA	1SNK159999R0000	20	11.00

Complete list of accessories is indicated in the terminal block datasheet including end stops. Some accessories such as jumper bars may modify the terminal block's ratings: Complete information available in the accessories section of the catalog.

Technical data valid for copper conductors only.

ZK2.5-SF-R PI-Spring terminal blocks

For 5x20 fuses - with blown fuse indicator - 6 mm 0.236 in spacing

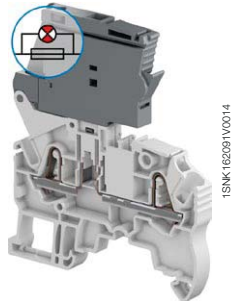

ZK2.5-SF-R

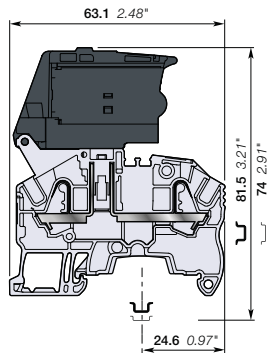

6 mm 0.236 in spacing

Description

- Protect your circuits with 5x20 fuse terminal blocks compliant with IEC 60947-7-3 standard (fuse not supplied with the terminal blocks),
- Simplify the distribution thanks to the 2 jumper channels aligned with ZK4-3P feed-through and ZK2.5-S-R1 disconnect terminal blocks,
- Quickly identify the defective circuit thanks to the blown fuse indicator (with leakage current < 0.5 mA).

Ordering details

Description	Color	Type	Part Number	Pkg qty	Weight (1 pce) g
Fuse with blown fuse indicator 24 ... 110 V AC / DC	Grey, dark grey	ZK2.5-SF-R1	1SNK706411R0000	50	16.30
with blown fuse indicator 115 ... 250 V AC / DC		ZK2.5-SF-R3	1SNK706412R0000	50	16.30

Main technical data

Connecting capacity		IEC	UL - CSA	Mounting instructions	
1 conductor per clamp	Rigid: Solid/Stranded	0.2 ... 4 mm ²	26 ... 12 AWG	Rail	TH 35-7.5, TH 35-15
	Flexible without ferrule	0.22 ... 2.5 mm ²		Wire stripping length	11 mm 0.433 in
	Flexible with non insulated ferrule	0.22 ... 2.5 mm ²	26 ... 14 AWG		
	Flexible with insulated ferrule	0.22 ... 2.5 mm ²	26 ... 14 AWG		
2 conductors per clamp	Flexible with twin ferrule	0.22 ... 0.5 mm ²	26 ... 20 AWG	Tool (for flexible conductor without ferrule)	Flat screwdriver Ø 3.5 mm Ø 0.138 in
Rated current / Rated cross section		6.3 A / 2.5 mm ²	16 A / 12 AWG		
Rated short-time withstand current (1s)			396 A		
Rated voltage		500 V	300 V		
Impulse withstand voltage		6000 V			
Protection		IP20	NEMA 1		

The fuse holder must be first disconnected prior any fuse replacement. Mount your fuse safely without touching any active part: put the fuse into the hooks of the fuse holder shutter; at the closing of the shutter, the fuse is perfectly in place in the fuse holder.

Separate arrangement		Assembly composed of 1 fuse terminal block in between non fuse terminal blocks	Overload and short-circuit protection	2.5 W
			Exclusive short-circuit protection	4 W
Compound arrangement		Assembly composed of 5 fuse terminal blocks	Overload and short-circuit protection	1.6 W
			Exclusive short-circuit protection	4 W

The connecting capacity data for one Rigid: Solid/Stranded, or one Flexible conductor (when applicable) is a mandatory information required by IEC, UL and CSA standards (Copper conductors). All other data are provided as supplementary information only. For more details, please consult our CB, UL or CSA certificates and technical datasheet available on <http://www.TE.com>

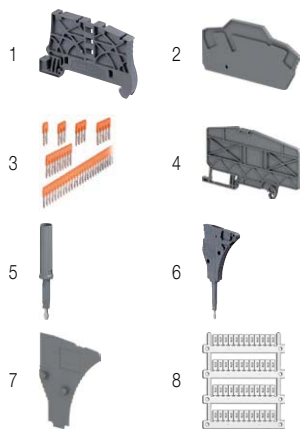
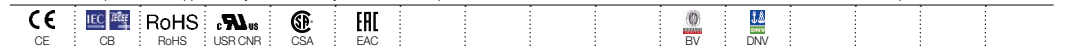

Accessories

Description	Color	Type	Part Number	Pkg qty	Weight (1 pce) g	
1 End stops	Dark grey	BAZ1	1SNK900002R0000	50	5.30	
2 End sections	Dark grey	EK2.5-3P	1SNK705911R0000	20	2.40	
3 Jumper bars	Orange	2 poles	JB6-2	1SNK906302R0000	50	1.30
		3 poles	JB6-3	1SNK906303R0000	50	2.10
		4 poles	JB6-4	1SNK906304R0000	50	2.90
		5 poles	JB6-5	1SNK906305R0000	50	3.60
		10 poles	JB6-10	1SNK906310R0000	20	7.40
		50 poles	JB6-50	1SNK906350R0000	10	38.10
4 Circuit separators	Dark grey	CS-R3	1SNK900107R0000	20	6.40	
5 Test adapters	Dark grey	For test plugs DIA 2 mm 0.079 in	TP2	1SNK900203R0000	20	1.70
		For test plugs DIA 4 mm 0.157 in	TP4	1SNK900205R0000	20	2.40
		End module, 5.2 mm 0.205 in	TC5-R1	1SNK900201R0000	10	5.20
6 Test connectors	Dark grey	TC5-R1	1SNK900201R0000	10	5.20	
7 Spacers	Dark grey	ES-TC6	1SNK900105R0000	10	0.80	
		MG-CPM 13 41791	1SNB041791R0612	1680	0.27	
		MC612	1SNK150000R0000	22	10.00	
8 Terminal block markers	White	MC612	1SNK150000R0000	22	10.00	
		MC612PA	1SNK159999R0000	20	11.00	

Complete list of accessories is indicated in the terminal block datasheet including end stops.

Some accessories such as jumper bars may modify the terminal block's ratings: Complete information available in the accessories section of the catalog.

Technical data valid for copper conductors only.

ZK2.5-D2 PI-Spring terminal blocks

Double deck with 2 feed-through circuits - 5.2 mm 0.205 in spacing



ZK2.5-D2

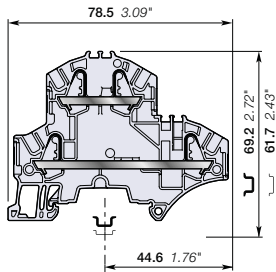

5.2 mm 0.205 in spacing

Description

Combine high performance with compact dimensions:

- 800 V IEC 600 V UL,
- 2 jumper channels and a large input and output marker zone on each deck.

Ordering details

Description	Color	Type	Part Number	Pkg qty	Weight (1 pce) g
Feed-through 2 feed-through circuits	Grey <input type="checkbox"/>	ZK2.5-D2	1SNK705210R0000	50	11.20
	Blue <input type="checkbox"/>	ZK2.5-D2-BL	1SNK705220R0000	50	11.20

Main technical data

Connecting capacity	IEC	UL - CSA	Mounting instructions
1 conductor per clamp	Rigid: Solid/Stranded	0.2 ... 4 mm ²	26 ... 12 AWG
	Flexible without ferrule	0.22 ... 2.5 mm ²	
	Flexible with non insulated ferrule	0.22 ... 2.5 mm ²	26 ... 14 AWG
	Flexible with insulated ferrule	0.22 ... 2.5 mm ²	26 ... 14 AWG
2 conductors per clamp	Flexible with twin ferrule	0.22 ... 0.5 mm ²	26 ... 20 AWG
Rated current / Rated cross section		24 A / 2.5 mm ²	20 A / 12 AWG
Rated short-time withstand current (1s)		300 A	396 A
Short Circuit Current Rating (with specific conditions)			100 kA
Rated voltage		800 V	600 V
Impulse withstand voltage		8000 V	
Protection		IP20	NEMA 1
Increased safety Ex e		693 V 21 A IEC/EN 60079-7 - IM2 II 2 GD Ex eb I/IC/IIIC	

The connecting capacity data for one Rigid: Solid/Stranded, or one Flexible conductor (when applicable) is a mandatory information required by IEC, UL and CSA standards (Copper conductors). All other data are provided as supplementary information only. For more details, please consult our CB, UL or CSA certificates and technical datasheet available on <http://www.TE.com>



Accessories

Description	Color	Type	Part Number	Pkg qty	Weight (1 pce) g	
1 End stops 10 mm 0.394 in	Dark grey <input type="checkbox"/>	BAZH1	1SNK900102R0000	20	24.00	
2 End sections 2 mm 0.079 in	Dark grey <input type="checkbox"/>	EK2.5-D2	1SNK705960R0000	20	3.40	
3 Jumper bars	Orange <input type="checkbox"/>	2 poles 32 A (IEC)	JB5-2	1SNK905302R0000	50	1.30
		3 poles 32 A (IEC)	JB5-3	1SNK905303R0000	50	2.00
		4 poles 32 A (IEC)	JB5-4	1SNK905304R0000	50	2.70
		5 poles 32 A (IEC)	JB5-5	1SNK905305R0000	50	3.50
		10 poles 32 A (IEC)	JB5-10	1SNK905310R0000	30	7.10
		50 poles 32 A (IEC)	JB5-50	1SNK905350R0000	10	36.00
4 Test adapters	Dark grey <input type="checkbox"/>	For test plugs DIA 2 mm 0.079 in	TP2	1SNK900203R0000	20	1.70
		For test plugs DIA 4 mm 0.157 in	TP4	1SNK900205R0000	20	2.40
5 Test connectors 5.2 mm 0.205 in spacing	Dark grey <input type="checkbox"/>	End module, 5.2 mm 0.205 in	TC5	1SNK900200R0000	10	5.20
			TC5-R1	1SNK900201R0000	10	5.20
6 Shield connectors		SHB	1SNK900602R0000	20	4.90	
7 Label holders	Dark grey <input type="checkbox"/>	LH-J	1SNK900606R0000	100	0.73	
8 Terminal block markers	White <input type="checkbox"/>	Blank marker	MG-CPM 13 41790	1SNB041790R0512	1960	0.23
		Blank card	MC512	1SNK140000R0000	22	9.00
			MC512PA	1SNK149999R0000	20	10.00
	Universal wire markers holder	Grey <input type="checkbox"/>	UMH	1SNK900611R0000	10	0.20

Complete list of accessories is indicated in the terminal block datasheet including end stops. Some accessories such as jumper bars may modify the terminal block's ratings: Complete information available in the accessories section of the catalog.



Ground PI-Spring terminal blocks

Description	Color	Type	Part Number	Pkg qty	Weight (1 pce) g
Ground Profile aligned with ZK2.5-D2 and ZK2.5-D1	Green-yellow <input type="checkbox"/>	ZK2.5-D1-PE	1SNK705250R0000	20	15.70

Technical data valid for copper conductors only.

ZK2.5-D1 PI-Spring terminal blocks

Double deck with 1 feed-through circuit - 5.2 mm 0.205 in spacing



ZK2.5-D1

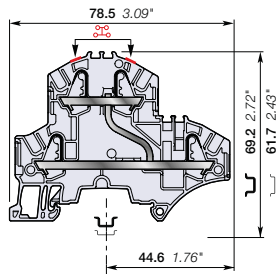

5.2 mm 0.205 in spacing

Description

– Find the same functionalities as ZK2.5-D2 and ease one potential distribution on 4 independent connections.

Ordering details

Description	Color	Type	Part Number	Pkg qty	Weight (1 pce) g
Feed-through 1 feed-through circuit	Grey	ZK2.5-D1	1SNK705211R0000	50	11.20

Main technical data

Connecting capacity		IEC	UL - CSA	Mounting instructions	
1 conductor per clamp	Rigid: Solid/Stranded	0.2 ... 4 mm ²	26 ... 12 AWG	Rail	TH 35-7.5, TH 35-15
	Flexible without ferrule	0.22 ... 2.5 mm ²	26 ... 14 AWG	Wire stripping length	11 mm 0.433 in
	Flexible with non insulated ferrule	0.22 ... 2.5 mm ²	26 ... 14 AWG	Tool (for flexible conductor without ferrule)	Flat screwdriver Ø 3.5 mm Ø 0.138 in
	Flexible with insulated ferrule	0.22 ... 2.5 mm ²	26 ... 14 AWG		
2 conductors per clamp	Flexible with twin ferrule	0.22 ... 0.5 mm ²	26 ... 20 AWG		
Rated current / Rated cross section		24 A / 2.5 mm ²	20 A / 12 AWG		
Rated short-time withstand current (1s)		300 A	396 A		
Short Circuit Current Rating (with specific conditions)			100 kA		
Rated voltage		800 V	600 V		
Impulse withstand voltage		8000 V			
Protection		IP20	NEMA 1		
Increased safety Ex e		693 V 21 A IEC/EN 60079-7 - IM2 II 2 GD Ex eb I/II/C/III/C			

The connecting capacity data for one Rigid: Solid/Stranded, or one Flexible conductor (when applicable) is a mandatory information required by IEC, UL and CSA standards (Copper conductors). All other data are provided as supplementary information only. For more details, please consult our CB, UL or CSA certificates and technical datasheet available on <http://www.TE.com>



Accessories

Description	Color	Type	Part Number	Pkg qty	Weight (1 pce) g	
1 End stops 10 mm 0.394 in	Dark grey	BAZH1	1SNK900102R0000	20	24.00	
2 End sections 2 mm 0.079 in	Dark grey	EK2.5-D2	1SNK705960R0000	20	3.40	
3 Jumper bars 2 poles 32 A (IEC) 3 poles 32 A (IEC) 4 poles 32 A (IEC) 5 poles 32 A (IEC) 10 poles 32 A (IEC) 50 poles 32 A (IEC)	Orange	JB5-2	1SNK905302R0000	50	1.30	
		JB5-3	1SNK905303R0000	50	2.00	
		JB5-4	1SNK905304R0000	50	2.70	
		JB5-5	1SNK905305R0000	50	3.50	
		JB5-10	1SNK905310R0000	30	7.10	
		JB5-50	1SNK905350R0000	10	36.00	
4 Test adapters For test plugs DIA 2 mm 0.079 in For test plugs DIA 4 mm 0.157 in	Dark grey	TP2	1SNK900203R0000	20	1.70	
		TP4	1SNK900205R0000	20	2.40	
5 Test connectors 5.2 mm 0.205 in spacing End module, 5.2 mm 0.205 in	Dark grey	TC5	1SNK900200R0000	10	5.20	
		TC5-R1	1SNK900201R0000	10	5.20	
		SHB	1SNK900602R0000	20	4.90	
6 Shield connectors		LH-J	1SNK900606R0000	100	0.73	
7 Label holders	Dark grey	LH-J	1SNK900606R0000	100	0.73	
		MG-CPM 13 41790	1SNB041790R0512	1960	0.23	
			MC512	1SNK140000R0000	22	9.00
			MC512PA	1SNK149999R0000	20	10.00
8 Terminal block markers Blank marker Blank card Universal wire markers holder	White Grey	UMH	1SNK900611R0000	10	0.20	

Complete list of accessories is indicated in the terminal block datasheet including end stops. Some accessories such as jumper bars may modify the terminal block's ratings: Complete information available in the accessories section of the catalog.

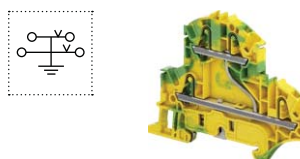

Ground PI-Spring terminal blocks

Description	Color	Type	Part Number	Pkg qty	Weight (1 pce) g
Ground Profile aligned with ZK2.5-D2 and ZK2.5-D1	Green-yellow	ZK2.5-D1-PE	1SNK705250R0000	20	15.70

Technical data valid for copper conductors only.

ZK2.5-D2-PE PI-Spring terminal blocks

Double deck with 1 feed-through circuit and 1 ground circuit - 5.2 mm 0.205 in spacing



2.5 mm²
12 AWG



1SNK162079R0014

ZK2.5-D2-PE

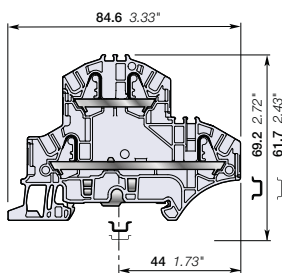

5.2 mm 0.205 in spacing

Description

Combine high performance with compact dimensions:

- 800 V IEC 600 V UL,
- 1 feed through circuit and 1 ground circuit in just 5.2 mm 0.205 in spacing,
- 2 jumper channels and a large input and output marker zone on each deck,
- designed for easy wiring.

Ordering details

Description	Color	Type	Part Number	Pkg qty	Weight (1 pce)
Feed-through + ground	Grey, Green-yellow	ZK2.5-D2-PE	1SNK705212R0000	20	15.70

Main technical data

Connecting capacity		IEC	UL - CSA	Mounting instructions	
1 conductor per clamp	Rigid: Solid/Stranded	0.2 ... 4 mm ²	26 ... 12 AWG	Rail	TH 35-7.5, TH 35-15
	Flexible without ferrule	0.22 ... 2.5 mm ²	26 ... 12 AWG	Wire stripping length	11 mm 0.433 in
	Flexible with non insulated ferrule	0.22 ... 2.5 mm ²	26 ... 14 AWG	Tool (for flexible conductor without ferrule)	Flat screwdriver Ø 3.5 mm Ø 0.138 in
	Flexible with insulated ferrule	0.22 ... 2.5 mm ²	26 ... 14 AWG		
2 conductors per clamp	Flexible with twin ferrule	0.22 ... 0.5 mm ²	26 ... 20 AWG		
Rated current / Rated cross section		24 A / 2.5 mm ²	20 A / 12 AWG		
Rated short-time withstand current (1s)		300 A	396 A		
Short Circuit Current Rating (with specific conditions)					
Rated voltage		800 V	600 V		
Impulse withstand voltage		8000 V			
Protection		IP20	NEMA 1		
Increased safety Ex e		693 V 21 A IEC/EN 60079-7 - IM2 II 2 GD Ex eb I/IC/IIIC			

The connecting capacity data for one Rigid: Solid/Stranded, or one Flexible conductor (when applicable) is a mandatory information required by IEC, UL and CSA standards (Copper conductors). All other data are provided as supplementary information only. For more details, please consult our CB, UL or CSA certificates and technical datasheet available on <http://www.TE.com>



Accessories

Description	Color	Type	Part Number	Pkg qty	Weight (1 pce)	
1 End stops	Dark grey	BAZH1	1SNK900102R0000	20	24.00	
2 End sections	Dark grey	EK2.5-D2	1SNK705960R0000	20	3.40	
3 Jumper bars	Orange	2 poles	JB5-2	1SNK905302R0000	50	1.30
		3 poles	JB5-3	1SNK905303R0000	50	2.00
		4 poles	JB5-4	1SNK905304R0000	50	2.70
		5 poles	JB5-5	1SNK905305R0000	50	3.50
		10 poles	JB5-10	1SNK905310R0000	30	7.10
		50 poles	JB5-50	1SNK905350R0000	10	36.00
4 Test adapters	Dark grey	For test plugs DIA 2 mm 0.079 in	TP2	1SNK900203R0000	20	1.70
		For test plugs DIA 4 mm 0.157 in	TP4	1SNK900205R0000	20	2.40
5 Test connectors	Dark grey	5.2 mm 0.205 in spacing	TC5	1SNK900200R0000	10	5.20
		End module, 5.2 mm 0.205 in	TC5-R1	1SNK900201R0000	10	5.20
6 Shield connectors		SHB	1SNK900602R0000	20	4.90	
7 Label holders	Dark grey	LH-J	1SNK900606R0000	100	0.73	
8 Terminal block markers	White	Blank marker	MG-CPM 13 41790	1SNB041790R0512	1960	0.23
		Blank card	MC512	1SNK140000R0000	22	9.00
			MC512PA	1SNK149999R0000	20	10.00
	Universal wire markers holder	Grey	UMH	1SNK900611R0000	10	0.20

Complete list of accessories is indicated in the terminal block datasheet including end stops. Some accessories such as jumper bars may modify the terminal block's ratings: Complete information available in the accessories section of the catalog.

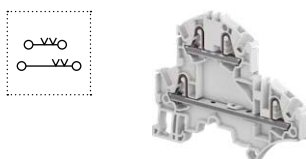

Feed-through PI-Spring terminal blocks

Description	Color	Type	Part Number	Pkg qty	Weight (1 pce)
Feed-through	Grey	ZK2.5-D2	1SNK705210R0000	50	11.20

Technical data valid for copper conductors only.

ZK2.5-D1-PE PI-Spring terminal blocks

Double deck with 1 ground circuit - 5.2 mm 0.205 in spacing

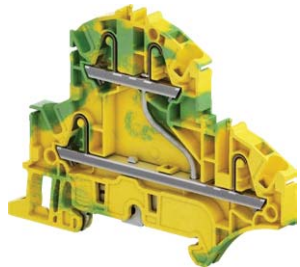

ZK2.5-D1-PE

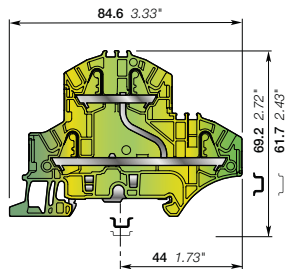

5.2 mm 0.205 in spacing

Description

Improve the safety of your installation in the event of a short-circuit thanks to our screwless rail contact:

- Rail contact non operator dependent,
- Performances above the requirements of the IEC 60947-7-2 terminal block standard,
- Secured snap on or off the rail,
- Profile aligned with ZK2.5-D2.

Ordering details

Description	Color	Type	Part Number	Pkg qty	Weight (1 pce) g
Ground 1 ground circuit	Green-yellow	ZK2.5-D1-PE	1SNK705250R0000	20	15.70

Main technical data

Connecting capacity	IEC	UL - CSA	Mounting instructions
1 conductor per clamp Rigid: Solid/Stranded Flexible without ferrule Flexible with non insulated ferrule Flexible with insulated ferrule	0.2 ... 4 mm ²	26 ... 12 AWG	Rail TH 35-7.5, TH 35-15 Wire stripping length 11 mm 0.433 in
	0.22 ... 2.5 mm ²	26 ... 14 AWG	Tool (for flexible conductor without ferrule) Flat screwdriver Ø 3.5 mm Ø 0.138 in
	0.22 ... 2.5 mm ²	26 ... 14 AWG	
	0.22 ... 2.5 mm ²	26 ... 14 AWG	
Rated cross section	2.5 mm ²	12 AWG	
Rated short-time withstand current (1s)	300 A	396 A	
Protection	IP20	NEMA 1	
Explosive atmosphere classification	IM2 II 2 GD Ex eb I/IC/IIIC - Class I, Zone 1, AEx e II, Ex e II U		

The connecting capacity data for one Rigid: Solid/Stranded, or one Flexible conductor (when applicable) is a mandatory information required by IEC, UL and CSA standards (Copper conductors). All other data are provided as supplementary information only. For more details, please consult our CB, UL or CSA certificates and technical datasheet available on <http://www.TE.com>

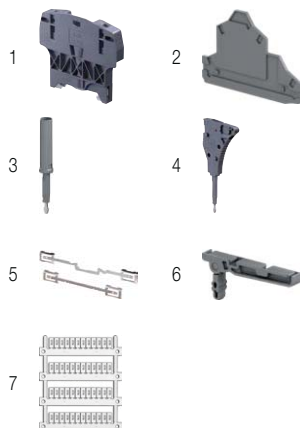

Accessories

Description	Color	Type	Part Number	Pkg qty	Weight (1 pce) g
1 End stops 10 mm 0.394 in	Dark grey	BAZH1	1SNK900102R0000	20	24.00
2 End sections 2 mm 0.079 in	Dark grey	EK2.5-D2	1SNK705960R0000	20	3.40
3 Test adapters For test plugs DIA 2 mm 0.079 in For test plugs DIA 4 mm 0.157 in	Dark grey	TP2	1SNK900203R0000	20	1.70
		TP4	1SNK900205R0000	20	2.40
4 Test connectors 5.2 mm 0.205 in spacing End module, 5.2 mm 0.205 in	Dark grey	TC5	1SNK900200R0000	10	5.20
		TC5-R1	1SNK900201R0000	10	5.20
5 Shield connectors		SHB	1SNK900602R0000	20	4.90
6 Label holders	Dark grey	LH-J	1SNK900606R0000	100	0.73
		MC512	1SNK140000R0000	22	9.00
7 Terminal block markers Blank marker Blank card Universal wire markers holder	White	MG-CPM 13 41790	1SNB041790R0512	1960	0.23
		MC512PA	1SNK149999R0000	20	10.00
		UMH	1SNK900611R0000	10	0.20

Complete list of accessories is indicated in the terminal block datasheet including end stops. Some accessories such as jumper bars may modify the terminal block's ratings: Complete information available in the accessories section of the catalog.

Technical data valid for copper conductors only.

ZK2.5-T3 PI-Spring terminal blocks

Triple deck with 3 feed-through circuits - 5.2 mm 0.205 in spacing



ZK2.5-T3

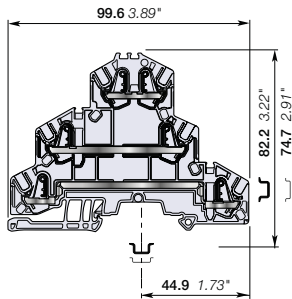

5.2 mm 0.205 in spacing

Description

Combine high performance with compact dimensions in just 5.2 mm 0.205 in spacing:
 - 500 V IEC 300 V UL,
 - 1 jumper channel and a large input and output marker zone on each deck.

Ordering details

Description	Color	Type	Part Number	Pkg qty	Weight (1 pce) g
Feed-through 3 feed-through circuits	Grey	ZK2.5-T3	1SNK705510R0000	25	17.33

Main technical data

Connecting capacity		IEC	UL - CSA	Mounting instructions	
1 conductor per clamp	Rigid: Solid/Stranded	0.2 ... 4 mm ²	26 ... 12 AWG	Rail	TH 35-7.5, TH 35-15
	Flexible without ferrule	0.22 ... 2.5 mm ²		Wire stripping length	11 mm 0.433 in
	Flexible with non insulated ferrule	0.22 ... 2.5 mm ²	26 ... 14 AWG		
	Flexible with insulated ferrule	0.22 ... 2.5 mm ²	26 ... 14 AWG		
2 conductors per clamp	Flexible with twin ferrule	0.22 ... 0.5 mm ²	26 ... 20 AWG	Tool (for flexible conductor without ferrule)	Flat screwdriver Ø 3.5 mm Ø 0.138 in
Rated current / Rated cross section		22 A / 2.5 mm ²	20 A / 12 AWG		
Rated short-time withstand current (1s)		300 A			
Short Circuit Current Rating (with specific conditions)					
Rated voltage		500 V	300 V		
Impulse withstand voltage		8000 V			
Protection		IP20	NEMA 1		
Increased safety Ex e		440 V 20 A IEC/EN 60079-7 - IM2 II 2 GD Ex eb IIC/IIC			

The connecting capacity data for one Rigid: Solid/Stranded, or one Flexible conductor (when applicable) is a mandatory information required by IEC, UL and CSA standards (Copper conductors). All other data are provided as supplementary information only. For more details, please consult our CB, UL or CSA certificates and technical datasheet available on <http://www.TE.com>



Accessories

Description	Color	Type	Part Number	Pkg qty	Weight (1 pce) g
1 End stops 10 mm 0.394 in	Dark grey	BAZH1	1SNK900102R0000	20	24.00
2 End sections 0.8 mm 0.031 in	Dark grey	EK2.5-T3	1SNK705961R0000	20	4.76
3 Jumper bars 2 poles 32 A (IEC) 3 poles 32 A (IEC) 4 poles 32 A (IEC) 5 poles 32 A (IEC) 10 poles 32 A (IEC) 50 poles 32 A (IEC)	Orange	JB5-2	1SNK905302R0000	50	1.30
		JB5-3	1SNK905303R0000	50	2.00
		JB5-4	1SNK905304R0000	50	2.70
		JB5-5	1SNK905305R0000	50	3.50
		JB5-10	1SNK905310R0000	30	7.10
		JB5-50	1SNK905350R0000	10	36.00
4 Test adapters For test plugs DIA 2 mm 0.079 in For test plugs DIA 4 mm 0.157 in	Dark grey	TP2	1SNK900203R0000	20	1.70
		TP4	1SNK900205R0000	20	2.40
5 Test connectors 5.2 mm 0.205 in spacing End module, 5.2 mm 0.205 in	Dark grey	TC5	1SNK900200R0000	10	5.20
		TC5-R1	1SNK900201R0000	10	5.20
6 Label holders	Dark grey	LH-J	1SNK900606R0000	100	0.73
		MG-CPM 13 41790	1SNB041790R0512	1960	0.23
		MC512	1SNK140000R0000	22	9.00
		MC512PA	1SNK149999R0000	20	10.00
7 Terminal block markers Blank marker Blank card Universal wire markers holder	White	UMH	1SNK900611R0000	10	0.20

Complete list of accessories is indicated in the terminal block datasheet including end stops.
 Some accessories such as jumper bars may modify the terminal block's ratings: Complete information available in the accessories section of the catalog.



Ground PI-Spring terminal blocks

Description	Color	Type	Part Number	Pkg qty	Weight (1 pce) g
Ground	Green-yellow	ZK2.5-T1-PE	1SNK705550R0000	25	21.53

Technical data valid for copper conductors only.

ZK2.5-T1 PI-Spring terminal blocks

Triple deck with 1 feed-through circuit - 5.2 mm 0.205 in spacing



ZK2.5-T1

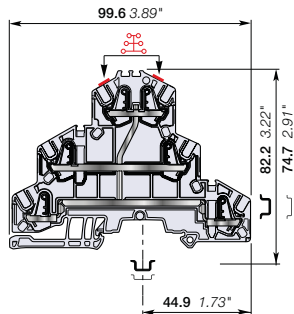

5.2 mm 0.205 in spacing

Description

Find the same functionalities as ZK2.5-T3 and ease one potential distribution on 6 independent connections.

Ordering details

Description	Color	Type	Part Number	Pkg qty	Weight (1 pce) g
Feed-through 1 feed-through circuit	Grey	ZK2.5-T1	1SNK705511R0000	25	17.33

Main technical data

Connecting capacity		IEC	UL - CSA	Mounting instructions	
1 conductor per clamp	Rigid: Solid/Stranded	0.2 ... 4 mm²	26 ... 12 AWG	Rail	TH 35-7.5, TH 35-15
	Flexible without ferrule	0.22 ... 2.5 mm²		Wire stripping length	11 mm 0.433 in
	Flexible with non insulated ferrule	0.22 ... 2.5 mm²	26 ... 14 AWG		
	Flexible with insulated ferrule	0.22 ... 2.5 mm²	26 ... 14 AWG		
2 conductors per clamp	Flexible with twin ferrule	0.22 ... 0.5 mm²	26 ... 20 AWG	Tool (for flexible conductor without ferrule)	Flat screwdriver Ø 3.5 mm Ø 0.138 in
Rated current / Rated cross section		22 A / 2.5 mm²	20 A / 12 AWG		
Rated short-time withstand current (1s)		300 A			
Short Circuit Current Rating (with specific conditions)					
Rated voltage		500 V	300 V		
Impulse withstand voltage		8000 V			
Protection		IP20	NEMA 1		
Increased safety Ex e		440 V 20 A IEC/EN 60079-7 - IM2 II 2 GD Ex eb I/II/C/III/C			

The connecting capacity data for one Rigid: Solid/Stranded, or one Flexible conductor (when applicable) is a mandatory information required by IEC, UL and CSA standards (Copper conductors). All other data are provided as supplementary information only. For more details, please consult our CB, UL or CSA certificates and technical datasheet available on <http://www.TE.com>

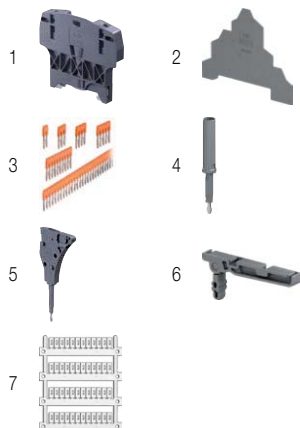

Accessories

Description	Color	Type	Part Number	Pkg qty	Weight (1 pce) g	
1 End stops	Dark grey	BAZH1	1SNK900102R0000	20	24.00	
2 End sections	Dark grey	EK2.5-T3	1SNK705961R0000	20	4.76	
3 Jumper bars	Orange	2 poles	JB5-2	1SNK905302R0000	50	1.30
		3 poles	JB5-3	1SNK905303R0000	50	2.00
		4 poles	JB5-4	1SNK905304R0000	50	2.70
		5 poles	JB5-5	1SNK905305R0000	50	3.50
		10 poles	JB5-10	1SNK905310R0000	30	7.10
		50 poles	JB5-50	1SNK905350R0000	10	36.00
4 Test adapters	Dark grey	For test plugs DIA 2 mm 0.079 in	TP2	1SNK900203R0000	20	1.70
		For test plugs DIA 4 mm 0.157 in	TP4	1SNK900205R0000	20	2.40
5 Test connectors	Dark grey	5.2 mm 0.205 in spacing	TC5	1SNK900200R0000	10	5.20
		End module, 5.2 mm 0.205 in	TC5-R1	1SNK900201R0000	10	5.20
6 Label holders	Dark grey	LH-J	1SNK900606R0000	100	0.73	
7 Terminal block markers	White	Blank marker	MG-CPM 13 41790	1SNB041790R0512	1960	0.23
		Blank card	MC512	1SNK140000R0000	22	9.00
	Grey		MC512PA	1SNK149999R0000	20	10.00
		Universal wire markers holder	UMH	1SNK900611R0000	10	0.20

Complete list of accessories is indicated in the terminal block datasheet including end stops. Some accessories such as jumper bars may modify the terminal block's ratings. Complete information available in the accessories section of the catalog.



Ground PI-Spring terminal blocks

Description	Color	Type	Part Number	Pkg qty	Weight (1 pce) g
Ground	Green-yellow	ZK2.5-T1-PE	1SNK705550R0000	25	21.53

Technical data valid for copper conductors only.

ZK2.5-L-L-PE PI-Spring terminal blocks

Triple deck with 2 feed-through circuits and 1 ground circuit - 5.2 mm 0.205 in spacing



1SNK102112R0014

ZK2.5-L-L-PE

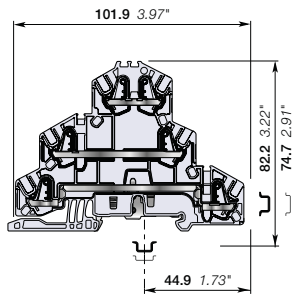

5.2 mm 0.205 in spacing

Description

Combine high performance with compact dimensions:

- 500V IEC 300 V UL,
- 2 feed through circuits and 1 ground circuit in just 5.2 mm 0.205 in spacing,
- 1 jumper channel and a large input and output marker zone on each deck,
- designed for easy wiring.

Ordering details

Description	Color	Type	Part Number	Pkg qty	Weight (1 pce)
Feed-through + ground	Grey, Green-yellow	ZK2.5-L-L-PE	1SNK705512R0000	25	21.38 g

Main technical data

Connecting capacity		IEC	UL - CSA	Mounting instructions	
1 conductor per clamp	Rigid: Solid/Stranded	0.2 ... 4 mm ²	26 ... 12 AWG	Rail	TH 35-7.5, TH 35-15
	Flexible without ferrule	0.22 ... 2.5 mm ²	26 ... 12 AWG	Wire stripping length	11 mm 0.433 in
	Flexible with non insulated ferrule	0.22 ... 2.5 mm ²	26 ... 14 AWG		
	Flexible with insulated ferrule	0.22 ... 2.5 mm ²	26 ... 14 AWG		
2 conductors per clamp	Flexible with twin ferrule	0.22 ... 0.5 mm ²	26 ... 20 AWG	Tool (for flexible conductor without ferrule)	Flat screwdriver Ø 3.5 mm Ø 0.138 in
Rated current / Rated cross section		22 A / 2.5 mm ²	20 A / 12 AWG		
Rated short-time withstand current (1s)		300 A	396 A		
Short Circuit Current Rating (with specific conditions)					
Rated voltage		500 V	300 V		
Impulse withstand voltage		8000 V			
Protection		IP20	NEMA 1		
Increased safety Ex e		440 V 20 A IEC/EN 60079-7 - IM2 II 2 GD Ex eb IIC/IIC			

The connecting capacity data for one Rigid: Solid/Stranded, or one Flexible conductor (when applicable) is a mandatory information required by IEC, UL and CSA standards (Copper conductors). All other data are provided as supplementary information only. For more details, please consult our CB, UL or CSA certificates and technical datasheet available on <http://www.TE.com>



Accessories

Description	Color	Type	Part Number	Pkg qty	Weight (1 pce)	
1 End stops	Dark grey	BAZH1	1SNK900102R0000	20	24.00	
2 End sections	Dark grey	EK2.5-T3	1SNK705961R0000	20	4.76	
3 Jumper bars	Orange	2 poles	JB5-2	1SNK905302R0000	50	1.30
		3 poles	JB5-3	1SNK905303R0000	50	2.00
		4 poles	JB5-4	1SNK905304R0000	50	2.70
		5 poles	JB5-5	1SNK905305R0000	50	3.50
		10 poles	JB5-10	1SNK905310R0000	30	7.10
		50 poles	JB5-50	1SNK905350R0000	10	36.00
4 Test adapters	Dark grey	For test plugs DIA 2 mm 0.079 in	TP2	1SNK900203R0000	20	1.70
		For test plugs DIA 4 mm 0.157 in	TP4	1SNK900205R0000	20	2.40
5 Test connectors	Dark grey	5.2 mm 0.205 in spacing	TC5	1SNK900200R0000	10	5.20
		End module, 5.2 mm 0.205 in	TC5-R1	1SNK900201R0000	10	5.20
6 Label holders	Dark grey		LH-J	1SNK900606R0000	100	0.73
7 Terminal block markers	White	Blank marker	MG-CPM 13 41790	1SNB041790R0512	1960	0.23
		Blank card	MC512	1SNK140000R0000	22	9.00
			MC512PA	1SNK149999R0000	20	10.00
		Universal wire markers holder	Grey	UMH	1SNK900611R0000	10

Complete list of accessories is indicated in the terminal block datasheet including end stops. Some accessories such as jumper bars may modify the terminal block's ratings: Complete information available in the accessories section of the catalog.

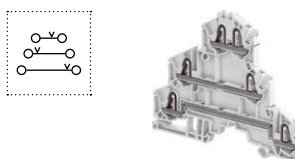

Feed-through PI-Spring terminal blocks

Description	Color	Type	Part Number	Pkg qty	Weight (1 pce)
Feed-through	Grey	ZK2.5-T3	1SNK705510R0000	25	17.33 g

Technical data valid for copper conductors only.

ZK2.5-L-N-PE PI-Spring terminal blocks

Triple deck with 2 feed-through circuits and 1 ground circuit - 5.2 mm 0.205 in spacing



ZK2.5-L-N-PE

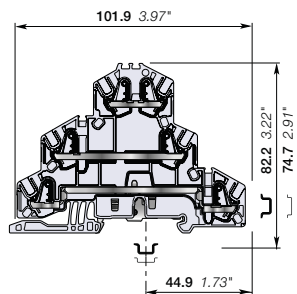

5.2 mm 0.205 in spacing

Description

Combine high performance with compact dimensions:

- 500 V IEC 300 V UL,
- 2 feed through circuits, phase and neutral, and 1 ground circuit in just 5.2 mm 0.205 in spacing,
- 1 jumper channel and a large input and output marker zone on each deck,
- designed for easy wiring.

Ordering details

Description	Color	Type	Part Number	Pkg qty	Weight (1 pce) g
Feed-through + ground	Blue, grey, Green-yellow	ZK2.5-L-N-PE	1SNK705513R0000	25	21.38

Main technical data

Connecting capacity		IEC	UL - CSA	Mounting instructions	
1 conductor per clamp	Rigid: Solid/Stranded	0.2 ... 4 mm²	26 ... 12 AWG	Rail	TH 35-7.5, TH 35-15
	Flexible without ferrule	0.22 ... 2.5 mm²			
	Flexible with non insulated ferrule	0.22 ... 2.5 mm²	26 ... 14 AWG	Wire stripping length	11 mm 0.433 in
	Flexible with insulated ferrule	0.22 ... 2.5 mm²	26 ... 14 AWG		
2 conductors per clamp	Flexible with twin ferrule	0.22 ... 0.5 mm²	26 ... 20 AWG	Tool (for flexible conductor without ferrule)	Flat screwdriver Ø 3.5 mm Ø 0.138 in
Rated current / Rated cross section		22 A / 2.5 mm²	20 A / 12 AWG		
Rated short-time withstand current (1s)		300 A	396 A		
Short Circuit Current Rating (with specific conditions)					
Rated voltage		500 V	300 V		
Impulse withstand voltage		8000 V			
Protection		IP20	NEMA 1		
Increased safety Ex e		440 V 20 A IEC/EN 60079-7 - IM2 II 2 GD Ex eb I/IC/IIIC			

The connecting capacity data for one Rigid: Solid/Stranded, or one Flexible conductor (when applicable) is a mandatory information required by IEC, UL and CSA standards (Copper conductors). All other data are provided as supplementary information only. For more details, please consult our CB, UL or CSA certificates and technical datasheet available on <http://www.TE.com>



Accessories

Description	Color	Type	Part Number	Pkg qty	Weight (1 pce) g	
1 End stops	Dark grey	BAZH1	1SNK900102R0000	20	24.00	
2 End sections	Dark grey	EK2.5-T3	1SNK705961R0000	20	4.76	
3 Jumper bars	Orange	2 poles	JB5-2	1SNK905302R0000	50	1.30
		3 poles	JB5-3	1SNK905303R0000	50	2.00
		4 poles	JB5-4	1SNK905304R0000	50	2.70
		5 poles	JB5-5	1SNK905305R0000	50	3.50
		10 poles	JB5-10	1SNK905310R0000	30	7.10
		50 poles	JB5-50	1SNK905350R0000	10	36.00
4 Test adapters	Dark grey	For test plugs DIA 2 mm 0.079 in	TP2	1SNK900203R0000	20	1.70
		For test plugs DIA 4 mm 0.157 in	TP4	1SNK900205R0000	20	2.40
5 Test connectors	Dark grey	5.2 mm 0.205 in spacing	TC5	1SNK900200R0000	10	5.20
		End module, 5.2 mm 0.205 in	TC5-R1	1SNK900201R0000	10	5.20
6 Label holders	Dark grey	LH-J	1SNK900606R0000	100	0.73	
7 Terminal block markers	Blank marker	Blank marker	MG-CPM 13 41790	1SNB041790R0512	1960	0.23
		Blank card	MC512	1SNK140000R0000	22	9.00
	Universal wire markers holder	Grey	MC512PA	1SNK149999R0000	20	10.00
			UMH	1SNK900611R0000	10	0.20

Complete list of accessories is indicated in the terminal block datasheet including end stops. Some accessories such as jumper bars may modify the terminal block's ratings. Complete information available in the accessories section of the catalog.



Feed-through PI-Spring terminal blocks

Description	Color	Type	Part Number	Pkg qty	Weight (1 pce) g
Feed-through	Grey	ZK2.5-T3	1SNK705510R0000	25	17.33

Technical data valid for copper conductors only.



ZK2.5-T1-PE PI-Spring terminal blocks

Triple deck with 1 ground circuit - 5.2 mm 0.205 in spacing



1SNK16211V0014

ZK2.5-T1-PE

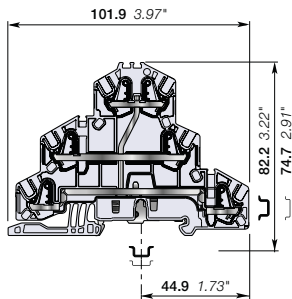

5.2 mm 0.205 in spacing

Description

Improve the safety of your installation in the event of a short-circuit thanks to our screwless rail contact:

- Rail contact non operator dependent,
- Performances above the requirements of the IEC 60947-7-2 terminal block standard,
- Secured snap on or off the rail,
- Profile aligned with ZK2.5-T3,
- 1 jumper channel on bottom and middle decks.

Ordering details

Description	Color	Type	Part Number	Pkg qty	Weight (1 pce) g
Ground 1 ground circuit	Green-yellow	ZK2.5-T1-PE	1SNK705550R0000	25	21.53

Main technical data

Connecting capacity		IEC	UL - CSA
1 conductor per clamp	Rigid: Solid/Stranded	0.2 ... 4 mm ²	26 ... 12 AWG
	Flexible without ferrule	0.22 ... 2.5 mm ²	
	Flexible with non insulated ferrule	0.22 ... 2.5 mm ²	26 ... 14 AWG
	Flexible with insulated ferrule	0.22 ... 2.5 mm ²	26 ... 14 AWG
Rated cross section		2.5 mm ²	12 AWG
Rated short-time withstand current (1s)		300 A	396 A
Protection		IP20	NEMA 1

Mounting instructions

Rail		TH 35-7.5, TH 35-15
Wire stripping length		11 mm 0.433 in
Tool (for flexible conductor without ferrule)		Flat screwdriver Ø 3.5 mm Ø 0.138 in

Explosive atmosphere classification

IM2 II 2 GD Ex eb I/IC/IIIC
The connecting capacity data for one Rigid: Solid/Stranded, or one Flexible conductor (when applicable) is a mandatory information required by IEC, UL and CSA standards (Copper conductors). All other data are provided as supplementary information only. For more details, please consult our CB, UL or CSA certificates and technical datasheet available on <http://www.TE.com>



Accessories

Description	Color	Type	Part Number	Pkg qty	Weight (1 pce) g
1 End stops 10 mm 0.394 in	Dark grey	BAZH1	1SNK900102R0000	20	24.00
2 End sections 0.8 mm 0.031 in	Dark grey	EK2.5-T3	1SNK705961R0000	20	4.76
3 Test adapters For test plugs DIA 2 mm 0.079 in For test plugs DIA 4 mm 0.157 in	Dark grey	TP2	1SNK900203R0000	20	1.70
		TP4	1SNK900205R0000	20	2.40
4 Test connectors 5.2 mm 0.205 in spacing End module, 5.2 mm 0.205 in	Dark grey	TC5	1SNK900200R0000	10	5.20
		TC5-R1	1SNK900201R0000	10	5.20
5 Label holders	Dark grey	LH-J	1SNK900606R0000	100	0.73
6 Terminal block markers Blank marker Blank card Universal wire markers holder	White	MG-CPM 13 41790	1SNB041790R0512	1960	0.23
		MC512	1SNK140000R0000	22	9.00
		MC512PA	1SNK149999R0000	20	10.00
	Grey	UMH	1SNK900611R0000	10	0.20

Complete list of accessories is indicated in the terminal block datasheet including end stops.

Some accessories such as jumper bars may modify the terminal block's ratings: Complete information available in the accessories section of the catalog.

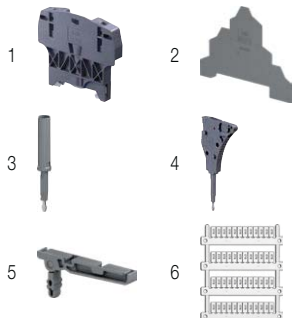

Technical data valid for copper conductors only.

ZK2.5-CH-4P-LR PI-Spring terminal blocks

Component holder - 5.2 mm 0.205 in spacing



ZK2.5-CH-4P

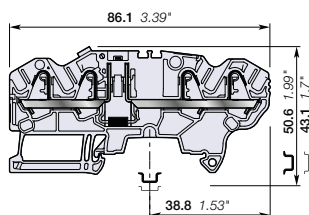

5.2 mm 0.205 in spacing

Description

- Protect your circuit with one 1N4007 diode,
- Clear identification of the diode orientation with marking identification on the top of the terminal block

Ordering details

Description	Color	Type	Part Number	Pkg qty	Weight (1 pce) g
Component holder with 1 test socket DIA 2 mm 0.079 in	Grey <input type="checkbox"/>	ZK2.5-CH-4P-LR	1SNK705710R0000	50	10.91

Main technical data

Connecting capacity		IEC	UL - CSA	Mounting instructions	
1 conductor per clamp	Rigid: Solid/Stranded	0.2 ... 4 mm ²	26 ... 12 AWG	Rail	TH 35-7.5, TH 35-15
	Flexible without ferrule	0.22 ... 2.5 mm ²	26 ... 14 AWG	Wire stripping length	11 mm 0.433 in
	Flexible with non insulated ferrule	0.22 ... 2.5 mm ²	26 ... 14 AWG	Tool (for flexible conductor without ferrule)	Flat screwdriver Ø 3.5 mm Ø 0.138 in
	Flexible with insulated ferrule	0.22 ... 2.5 mm ²	26 ... 14 AWG		
2 conductors per clamp	Flexible with twin ferrule	0.22 ... 0.5 mm ²	26 ... 20 AWG		
Rated current / Rated cross section		1 A / 2.5 mm ²	1 A / 12 AWG		
Rated short-time withstand current (1s)					
Short Circuit Current Rating (with specific conditions)					
Rated voltage		630 V	300 V		
Impulse withstand voltage					
Protection		IP20	NEMA 1		

The connecting capacity data for one Rigid: Solid/Stranded, or one Flexible conductor (when applicable) is a mandatory information required by IEC, UL and CSA standards (Copper conductors). All other data are provided as supplementary information only. For more details, please consult our CB, UL or CSA certificates and technical datasheet available on <http://www.TE.com>

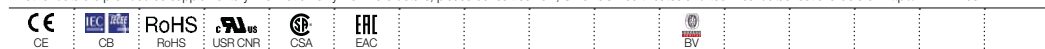

Accessories

Description	Color	Type	Part Number	Pkg qty	Weight (1 pce) g	
1 End stops	Dark grey <input type="checkbox"/>	BAZ1	1SNK900002R0000	50	5.30	
2 End sections	Dark grey <input type="checkbox"/>	EK2.5-S-4P	1SNK705913R0000	20	2.94	
3 Jumper bars	Orange <input type="checkbox"/>	2 poles	JB5-2	1SNK905302R0000	50	1.30
		3 poles	JB5-3	1SNK905303R0000	50	2.00
		4 poles	JB5-4	1SNK905304R0000	50	2.70
		5 poles	JB5-5	1SNK905305R0000	50	3.50
		10 poles	JB5-10	1SNK905310R0000	30	7.10
		50 poles	JB5-50	1SNK905350R0000	10	36.00
4 Circuit separators	Dark grey <input type="checkbox"/>	CS-R3	1SNK900107R0000	20	6.40	
5 Test adapters	Dark grey <input type="checkbox"/>	For test plugs DIA 2 mm 0.079 in	TP2	1SNK900203R0000	20	1.70
		For test plugs DIA 4 mm 0.157 in	TP4	1SNK900205R0000	20	2.40
		For test plugs DIA 2 mm 0.079 in	TP5	1SNK900206R0000	20	2.40
6 Test connectors	Dark grey <input type="checkbox"/>	5.2 mm 0.205 in spacing	TC5	1SNK900200R0000	10	5.20
		End module, 5.2 mm 0.205 in	TC5-R1	1SNK900201R0000	10	5.20
7 Terminal block markers	White <input type="checkbox"/>	Blank marker	MG-CPM 13 41790	1SNK041790R0512	1960	0.23
		Blank marker	MC512	1SNK140000R0000	22	9.00
		Blank card	MC512PA	1SNK149999R0000	20	10.00
		Universal wire markers holder	Grey <input type="checkbox"/>	UMH	1SNK900611R0000	10

Complete list of accessories is indicated in the terminal block datasheet including end stops. Some accessories such as jumper bars may modify the terminal block's ratings. Complete information available in the accessories section of the catalog.

Technical data valid for copper conductors only.

ZK2.5-CH-4P-RL PI-Spring terminal blocks

Component holder - 5.2 mm 0.205 in spacing



ZK2.5-CH-4P

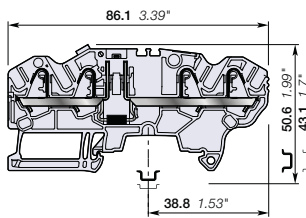

5.2 mm 0.205 in spacing

Description

- Protect your circuit with one 1N4007 diode,
- Clear identification of the diode orientation with marking identification on the top of the terminal block

Ordering details

Description	Color	Type	Part Number	Pkg qty	Weight (1 pce) g
Component holder with 1 test socket DIA 2 mm 0.079 in	Grey	ZK2.5-CH-4P-RL	1SNK705711R0000	50	10.91

Main technical data

Connecting capacity	IEC	UL - CSA	Mounting instructions
1 conductor per clamp Rigid: Solid/Stranded Flexible without ferrule Flexible with non insulated ferrule Flexible with insulated ferrule	0.2 ... 4 mm ² 0.22 ... 2.5 mm ² 0.22 ... 2.5 mm ² 0.22 ... 2.5 mm ²	26 ... 12 AWG 26 ... 14 AWG 26 ... 14 AWG	Rail TH 35-7.5, TH 35-15 11 mm 0.433 in Wire stripping length Tool (for flexible conductor without ferrule) Flat screwdriver Ø 3.5 mm Ø 0.138 in
2 conductors per clamp Flexible with twin ferrule	0.22 ... 0.5 mm ²	26 ... 20 AWG	
Rated current / Rated cross section Rated short-time withstand current (1s) Short Circuit Current Rating (with specific conditions) Rated voltage Impulse withstand voltage Protection	1 A / 2.5 mm ² 630 V IP20	1 A / 12 AWG 300 V NEMA 1	

The connecting capacity data for one Rigid: Solid/Stranded, or one Flexible conductor (when applicable) is a mandatory information required by IEC, UL and CSA standards (Copper conductors). All other data are provided as supplementary information only. For more details, please consult our CB, UL or CSA certificates and technical datasheet available on <http://www.TE.com>



Accessories

Description	Color	Type	Part Number	Pkg qty	Weight (1 pce) g
1 End stops 5.2 mm 0.205 in	Dark grey	BAZ1	1SNK900002R0000	50	5.30
2 End sections 2 mm 0.158 in	Dark grey	EK2.5-S-4P	1SNK705913R0000	20	2.94
3 Jumper bars 2 poles 32 A (IEC)	Orange	JB5-2	1SNK905302R0000	50	1.30
3 poles 32 A (IEC)		JB5-3	1SNK905303R0000	50	2.00
4 poles 32 A (IEC)		JB5-4	1SNK905304R0000	50	2.70
5 poles 32 A (IEC)		JB5-5	1SNK905305R0000	50	3.50
10 poles 32 A (IEC)		JB5-10	1SNK905310R0000	30	7.10
50 poles 32 A (IEC)		JB5-50	1SNK905350R0000	10	36.00
4 Circuit separators 3 mm 0.118 in	Dark grey	CS-R3	1SNK900107R0000	20	6.40
5 Test adapters For test plugs DIA 2 mm 0.079 in	Dark grey	TP2	1SNK900203R0000	20	1.70
For test plugs DIA 4 mm 0.157 in		TP4	1SNK900205R0000	20	2.40
6 Test connectors 5.2 mm 0.205 in spacing	Dark grey	TC5	1SNK900200R0000	10	5.20
End module, 5.2 mm 0.205 in		TC5-R1	1SNK900201R0000	10	5.20
7 Terminal block markers Blank marker	White	MG-CPM 13 41790	1SNB041790R0512	1960	0.23
Blank card		MC512	1SNK140000R0000	22	9.00
		MC512PA	1SNK149999R0000	20	10.00
Universal wire markers holder	Grey	UMH	1SNK900611R0000	10	0.20

Complete list of accessories is indicated in the terminal block datasheet including end stops. Some accessories such as jumper bars may modify the terminal block's ratings: Complete information available in the accessories section of the catalog.

Technical data valid for copper conductors only.

ZK2.5-D-CH-UD PI-Spring terminal blocks

Component holder - 5.2 mm 0.205 in spacing



Description

Protect your circuit with one 1N4007 diode.

Ordering details

Description	Color	Type	Part Number	Pkg qty	Weight (1 pce) g
Component holder	Grey <input type="checkbox"/>	ZK2.5-D-CH-UD	1SNK705213R0000	50	11.20

Main technical data

Connecting capacity		IEC	UL - CSA	Mounting instructions	
1 conductor per clamp	Rigid: Solid/Stranded	0.2 ... 4 mm ²	26 ... 12 AWG	Rail	TH 35-7.5, TH 35-15
	Flexible without ferrule	0.22 ... 2.5 mm ²		Wire stripping length	11 mm 0.443 in
	Flexible with non insulated ferrule	0.22 ... 2.5 mm ²	26 ... 14 AWG	Tool (for flexible conductor without ferrule)	Flat screwdriver Ø 3.5 mm Ø 0.138 in
	Flexible with insulated ferrule	0.22 ... 2.5 mm ²	26 ... 14 AWG		
2 conductors per clamp	Flexible with twin ferrule	0.22 ... 0.5 mm ²	26 ... 20 AWG		
Rated current / Rated cross section		24 A / 2.5 mm ²	20 A / 12 AWG		
Rated short-time withstand current (1s)		300 A			
Short Circuit Current Rating (with specific conditions)					
Rated voltage		800 V	600 V		
Impulse withstand voltage					
Protection		IP20	NEMA 1		

The connecting capacity data for one Rigid: Solid/Stranded, or one Flexible conductor (when applicable) is a mandatory information required by IEC, UL and CSA standards (Copper conductors). All other data are provided as supplementary information only. For more details, please consult our CB, UL or CSA certificates and technical datasheet available on <http://www.TE.com>

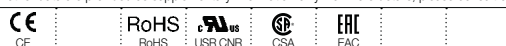

ZK2.5-D-CH

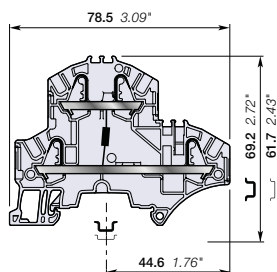

5.2 mm 0.205 in spacing

Accessories

Description	Color	Type	Part Number	Pkg qty	Weight (1 pce) g	
1 End stops 10 mm 0.394 in	Dark grey <input type="checkbox"/>	BAZH1	1SNK900102R0000	20	24.00	
2 End sections 2 mm 0.079 in	Dark grey <input type="checkbox"/>	EK2.5-D2	1SNK705960R0000	20	3.40	
3 Jumper bars	Orange <input type="checkbox"/>	2 poles 32 A (IEC)	JB5-2	1SNK905302R0000	50	1.30
		3 poles 32 A (IEC)	JB5-3	1SNK905303R0000	50	2.00
		4 poles 32 A (IEC)	JB5-4	1SNK905304R0000	50	2.70
		5 poles 32 A (IEC)	JB5-5	1SNK905305R0000	50	3.50
		10 poles 32 A (IEC)	JB5-10	1SNK905310R0000	30	7.10
		50 poles 32 A (IEC)	JB5-50	1SNK905350R0000	10	36.00
4 Test adapters	Dark grey <input type="checkbox"/>	For test plugs DIA 2 mm 0.079 in	TP2	1SNK900203R0000	20	1.70
		For test plugs DIA 4 mm 0.157 in	TP4	1SNK900205R0000	20	2.40
5 Test connectors	Dark grey <input type="checkbox"/>	5.2 mm 0.205 in spacing	TC5	1SNK900200R0000	10	5.20
		End module, 5.2 mm 0.205 in	TC5-R1	1SNK900201R0000	10	5.20
			SHB	1SNK900602R0000	20	4.90
6 Shield connectors						
7 Label holders	Dark grey <input type="checkbox"/>	LH-J	1SNK900606R0000	100	0.73	
8 Terminal block markers	White <input type="checkbox"/>	Blank marker	MG-CPM 13 41790	1SNB041790R0512	1960	0.23
		Blank card	MC512	1SNK140000R0000	22	9.00
			MC512PA	1SNK149999R0000	20	10.00
	Universal wire markers holder	Grey <input type="checkbox"/>	UMH	1SNK900611R0000	10	0.20

Complete list of accessories is indicated in the terminal block datasheet including end stops. Some accessories such as jumper bars may modify the terminal block's ratings. Complete information available in the accessories section of the catalog.

Technical data valid for copper conductors only.

ZK2.5-D-CH-DU PI-Spring terminal blocks

Component holder - 5.2 mm 0.205 in spacing



2.5 mm²
12 AWG

Description

Protect your circuit with one 1N4007 diode.

Ordering details

Description	Color	Type	Part Number	Pkg qty	Weight (1 pce) g
Component holder	Grey <input type="checkbox"/>	ZK2.5-D-CH-DU	1SNK705214R0000	50	11.20

Main technical data

Connecting capacity		IEC	UL - CSA	Mounting instructions	
1 conductor per clamp	Rigid: Solid/Stranded	0.2 ... 4 mm ²	26 ... 12 AWG	Rail	TH 35-7.5, TH 35-15
	Flexible without ferrule	0.22 ... 2.5 mm ²		Wire stripping length	11 mm 0.443 in
	Flexible with non insulated ferrule	0.22 ... 2.5 mm ²	26 ... 14 AWG	Tool (for flexible conductor without ferrule)	Flat screwdriver Ø 3.5 mm Ø 0.138 in
	Flexible with insulated ferrule	0.22 ... 2.5 mm ²	26 ... 14 AWG		
2 conductors per clamp	Flexible with twin ferrule	0.22 ... 0.5 mm ²	26 ... 20 AWG		
Rated current / Rated cross section		24 A / 2.5 mm ²	20 A / 12 AWG		
Rated short-time withstand current (1s)		300 A			
Short Circuit Current Rating (with specific conditions)					
Rated voltage		800 V	600 V		
Impulse withstand voltage					
Protection		IP20	NEMA 1		

The connecting capacity data for one Rigid: Solid/Stranded, or one Flexible conductor (when applicable) is a mandatory information required by IEC, UL and CSA standards (Copper conductors). All other data are provided as supplementary information only. For more details, please consult our CB, UL or CSA certificates and technical datasheet available on <http://www.TE.com>

CE	RoHS	UL	CSA	ERC	EAC
----	------	----	-----	-----	-----



1SNK162102X0014

ZK2.5-D-CH

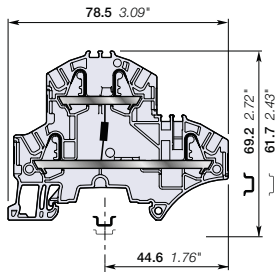

5.2 mm 0.205 in spacing

Accessories

Description	Color	Type	Part Number	Pkg qty	Weight (1 pce) g	
1 End stops 10 mm 0.394 in	Dark grey <input checked="" type="checkbox"/>	BAZH1	1SNK900102R0000	20	24.00	
2 End sections 2 mm 0.079 in	Dark grey <input checked="" type="checkbox"/>	EK2.5-D2	1SNK705960R0000	20	3.40	
3 Jumper bars	Orange <input checked="" type="checkbox"/>	2 poles 32 A (IEC)	JB5-2	1SNK905302R0000	50	1.30
		3 poles 32 A (IEC)	JB5-3	1SNK905303R0000	50	2.00
		4 poles 32 A (IEC)	JB5-4	1SNK905304R0000	50	2.70
		5 poles 32 A (IEC)	JB5-5	1SNK905305R0000	50	3.50
		10 poles 32 A (IEC)	JB5-10	1SNK905310R0000	30	7.10
4 Test adapters	Dark grey <input checked="" type="checkbox"/>	50 poles 32 A (IEC)	JB5-50	1SNK905350R0000	10	36.00
		For test plugs DIA 2 mm 0.079 in	TP2	1SNK900203R0000	20	1.70
		For test plugs DIA 4 mm 0.157 in	TP4	1SNK900205R0000	20	2.40
5 Test connectors 5.2 mm 0.205 in spacing	Dark grey <input checked="" type="checkbox"/>	End module, 5.2 mm 0.205 in	TC5	1SNK900200R0000	10	5.20
			TC5-R1	1SNK900201R0000	10	5.20
6 Shield connectors		SHB	1SNK900602R0000	20	4.90	
7 Label holders	Dark grey <input checked="" type="checkbox"/>	LH-J	1SNK900606R0000	100	0.73	
8 Terminal block markers	White <input type="checkbox"/>	Blank marker	MG-CPM 13 41790	1SNB041790R0512	1960	0.23
		Blank card	MC512	1SNK140000R0000	22	9.00
			MC512PA	1SNK149999R0000	20	10.00
	Universal wire markers holder	Grey <input type="checkbox"/>	UMH	1SNK900611R0000	10	0.20

Complete list of accessories is indicated in the terminal block datasheet including end stops. Some accessories such as jumper bars may modify the terminal block's ratings: Complete information available in the accessories section of the catalog.

Technical data valid for copper conductors only.

ZK2.5-D-CH2-DU-RL PI-Spring terminal blocks

Component holder - 5.2 mm 0.205 in spacing



Description

- Protect your circuit with 1N4007 diodes;
- Convenient identification of the diodes orientation on the terminal block front side.

Ordering details

Description	Color	Type	Part Number	Pkg qty	Weight (1 pce) g
Component holder	Grey <input type="checkbox"/>	ZK2.5-D-CH2-DU-RL	1SNK705219R0000	50	11.20

Main technical data

Connecting capacity		IEC	UL - CSA	Mounting instructions	
1 conductor per clamp	Rigid: Solid/Stranded	0.2 ... 4 mm ²	26 ... 12 AWG	Rail	TH 35-7.5, TH 35-15
	Flexible without ferrule	0.22 ... 2.5 mm ²		Wire stripping length	11 mm 0.443 in
	Flexible with non insulated ferrule	0.22 ... 2.5 mm ²	26 ... 14 AWG		
	Flexible with insulated ferrule	0.22 ... 2.5 mm ²	26 ... 14 AWG		
2 conductors per clamp	Flexible with twin ferrule	0.22 ... 0.5 mm ²	26 ... 20 AWG	Tool (for flexible conductor without ferrule)	Flat screwdriver Ø 3.5 mm Ø 0.138 in
Rated current / Rated cross section		1 A / 2.5 mm ² / 12 AWG			
Rated short-time withstand current (1s)					
Short Circuit Current Rating (with specific conditions)					
Rated voltage		800 V	600 V		
Impulse withstand voltage					
Protection		IP20	NEMA 1		



ZK2.5-D-CH2

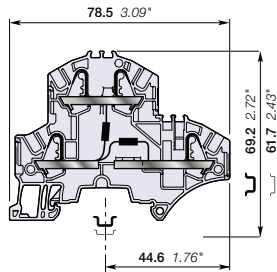

5.2 mm 0.205 in spacing

The connecting capacity data for one Rigid: Solid/Stranded, or one Flexible conductor (when applicable) is a mandatory information required by IEC, UL and CSA standards (Copper conductors). All other data are provided as supplementary information only. For more details, please consult our CB, UL or CSA certificates and technical datasheet available on <http://www.TE.com>

--	--	--	--	--	--	--	--	--	--

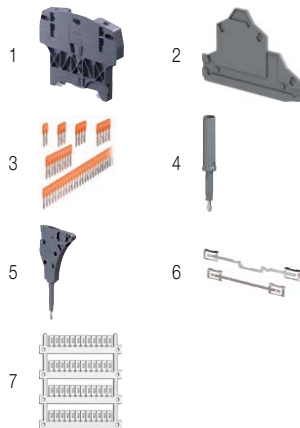

Accessories

Description	Color	Type	Part Number	Pkg qty	Weight (1 pce) g	
1 End stops	Dark grey <input type="checkbox"/>	BAZH1	1SNK900102R0000	20	24.00	
2 End sections	Dark grey <input type="checkbox"/>	EK2.5-D2	1SNK705960R0000	20	3.40	
3 Jumper bars	Orange <input type="checkbox"/>	2 poles	JB5-2	1SNK905302R0000	50	1.30
		3 poles	JB5-3	1SNK905303R0000	50	2.00
		4 poles	JB5-4	1SNK905304R0000	50	2.70
		5 poles	JB5-5	1SNK905305R0000	50	3.50
		10 poles	JB5-10	1SNK905310R0000	30	7.10
		50 poles	JB5-50	1SNK905350R0000	10	36.00
4 Test adapters	Dark grey <input type="checkbox"/>	For test plugs DIA 2 mm 0.079 in	TP2	1SNK900203R0000	20	1.70
		For test plugs DIA 4 mm 0.157 in	TP4	1SNK900205R0000	20	2.40
5 Test connectors	Dark grey <input type="checkbox"/>	5.2 mm 0.205 in spacing	TC5	1SNK900200R0000	10	5.20
		End module, 5.2 mm 0.205 in	TC5-R1	1SNK900201R0000	10	5.20
			SHB	1SNK900602R0000	20	4.90
6 Shield connectors	White <input type="checkbox"/>	Blank marker	MG-CPM 13 41790	1SNB041790R0512	1960	0.23
		Blank card	MC512	1SNK140000R0000	22	9.00
			MC512PA	1SNK149999R0000	20	10.00
		Universal wire markers holder	Grey <input type="checkbox"/>	UMH	1SNK900611R0000	10

Complete list of accessories is indicated in the terminal block datasheet including end stops. Some accessories such as jumper bars may modify the terminal block's ratings: Complete information available in the accessories section of the catalog.

Technical data valid for copper conductors only.

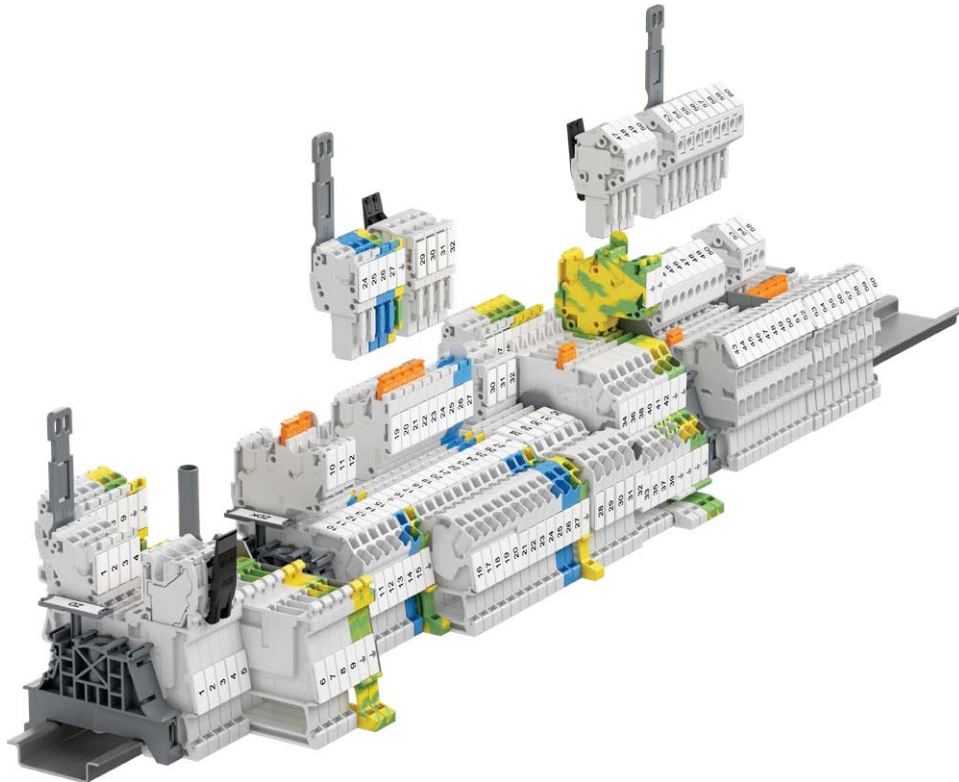

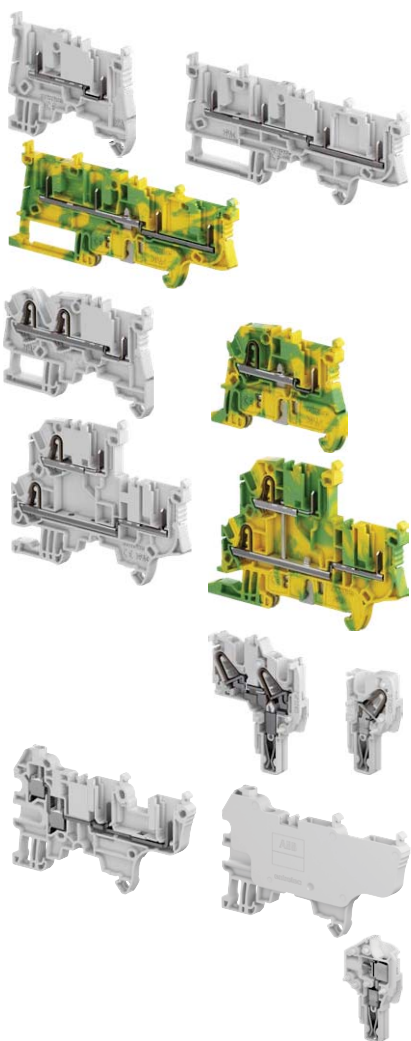

Technologies presentation			70
Overview			76
PI-Spring Pluggable			
Pluggable Pluggable			
2.5 mm ² / 12 AWG	Feed-through	ZD2.5-11	80
		ZD2.5-22	81
	Ground	ZD2.5-22-PE	82
PI-Spring Pluggable			
2.5 mm ² / 12 AWG	Feed-through	ZDK2.5-11	83
		ZDK2.5-21	84
		ZDK2.5-22	85
4 mm ² / 10 AWG	Feed-through	ZDK4-22	86
2.5 mm ² / 12 AWG	Ground	ZDK2.5-11-PE	87
		ZDK2.5-22-PE	88
	Double deck	ZDK2.5-D2	89
		ZDK2.5-D1	90
		ZDK2.5-D2-PE	91
		ZDK2.5-D1-PE	92
PI-Spring female plugs		CDK2.5	93
		CDK2.5-J	94
		CDK2.5-2P-J	95
		CDK4	96
Screw clamp Pluggable			
4 mm ² / 10 AWG	Feed-through	ZDS4-22	98
		ZDS4-22-R1	100
Screw clamp female plugs		CDS4	99
		CDS4-R1	101

Pluggable technology - SNK series, terminal blocks

Features and benefits

The SNK series pluggable terminal blocks combine the benefits of our smart connections with the flexibility of the pluggable function.

PI-Spring Pluggable



PI-Spring Pluggable



Pluggable Pluggable

Screw clamp Pluggable



Speed up your projects

Modularity brings assembly flexibility

Pluggable technology brings modularity into the electrical installation allowing the combination of sub-assemblies and prewired harnesses that facilitate and considerably accelerate assembly test and factory commissioning.

Better project identification

- Circuit identification is improved thanks to the 20% larger marking area
- Pre-mark by hand or with label on our flat marking surface and start immediately the wiring, before the final markers mounting
- Spare markers re-printing in case of modifications.

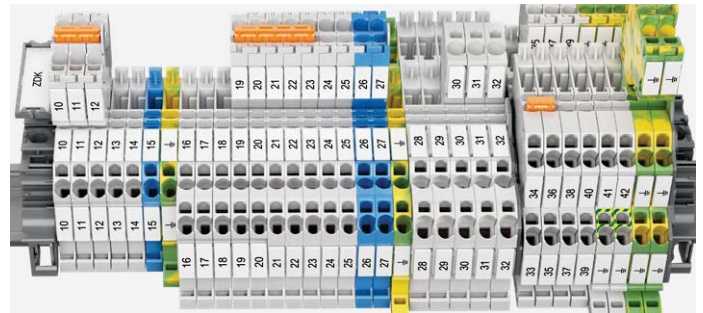

Clear circuit identification

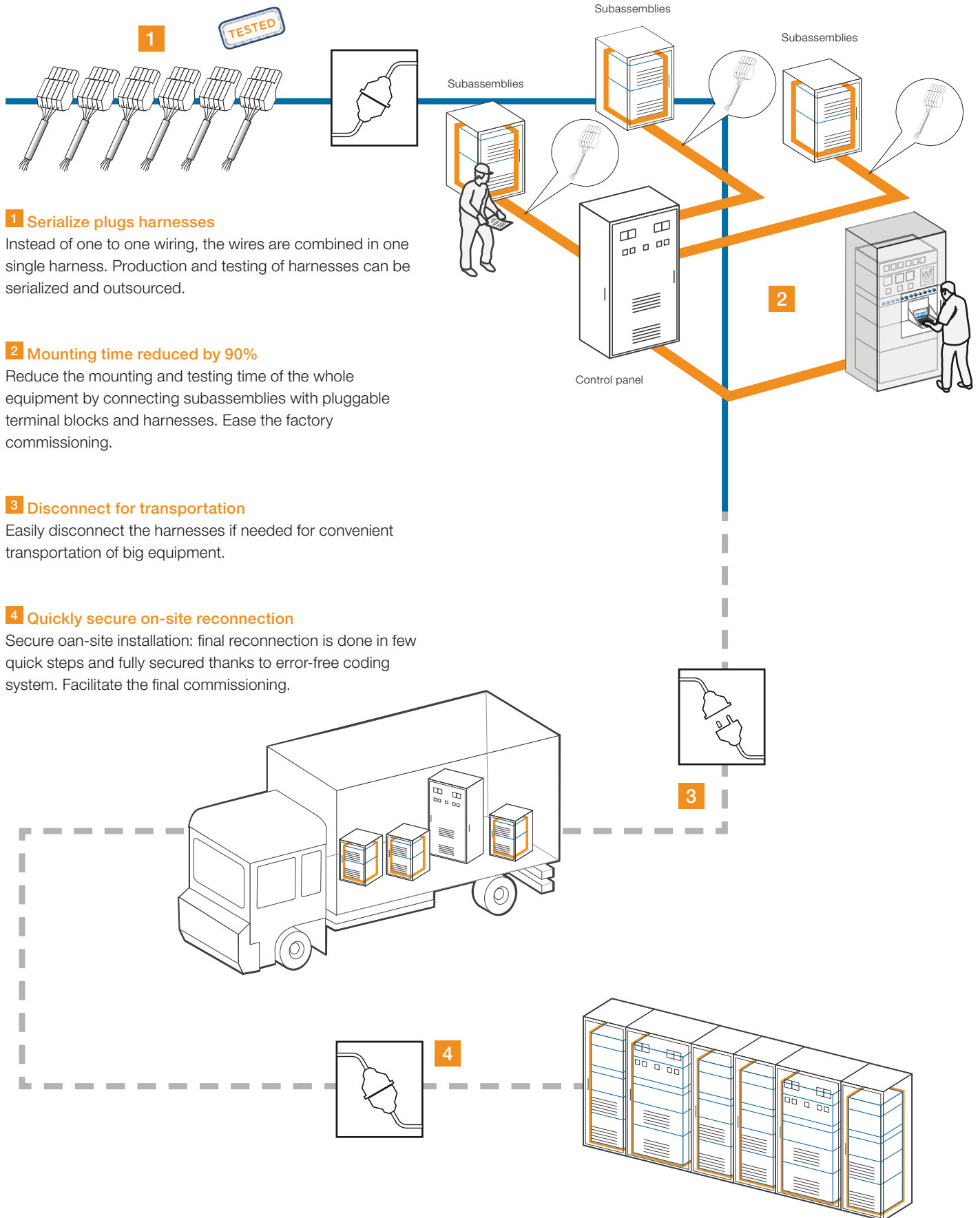

1 Serialize plugs harnesses

Instead of one to one wiring, the wires are combined in one single harness. Production and testing of harnesses can be serialized and outsourced.

2 Mounting time reduced by 90%

Reduce the mounting and testing time of the whole equipment by connecting subassemblies with pluggable terminal blocks and harnesses. Ease the factory commissioning.

3 Disconnect for transportation

Easily disconnect the harnesses if needed for convenient transportation of big equipment.

4 Quickly secure on-site reconnection

Secure on-site installation: final reconnection is done in few quick steps and fully secured thanks to error-free coding system. Facilitate the final commissioning.

3

3

4

Pluggable technology - SNK series, terminal blocks

Features and benefits

Easy to install

Smart design facilitating assembly process

Mounting, wiring, testing... made easy.

Create your own assemblies without tooling:

- Easily snap together multiple plugs
- Eliminate stock of pre-configured plugs.

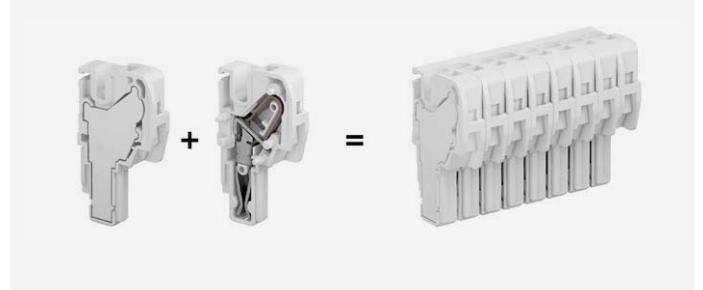

Only two plug variants are required to compose harnesses up to 15 poles

Some plugs feature a jumper channel and/or 2 connections that ease the signal distribution or wiring daisy chaining of subassemblies.

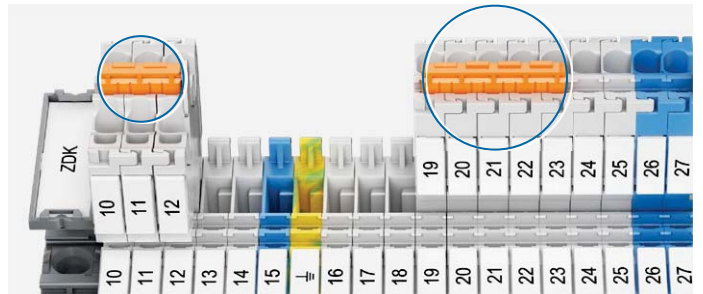

Easy signal distribution on plugs

Safety and protection

Eliminate connection errors with coding pegs:

- Simply insert the pegs to create a coding sequence.

Secure your wiring against accidental tearing:

- Automatic locking function
- Lock safely 2 to 8 plugs with only one locking device
- Cable clamp secures the wires onto the plug when pulling the plug assembly.



Convenient coding pegs

Cable clamp & locking device

SNK series, terminal blocks

Features and benefits

Faster accessories mounting

Save up to 70% mounting time thanks to:

- Screwless jumpers, component plugs, test devices, end stops and snap-in ground terminal blocks.

Closed jumper location allows great stiffness of the terminal block, avoid deflection while tightening and optimal jumper guiding.

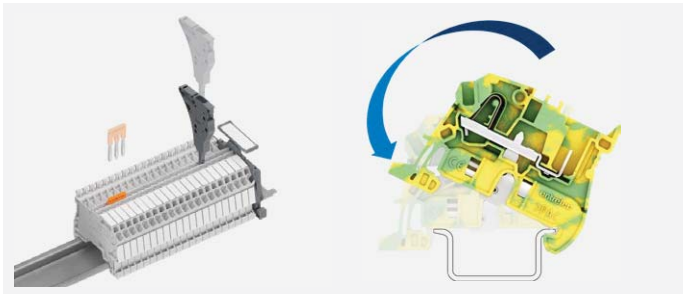

Screwless accessories

Snap-in ground terminal blocks

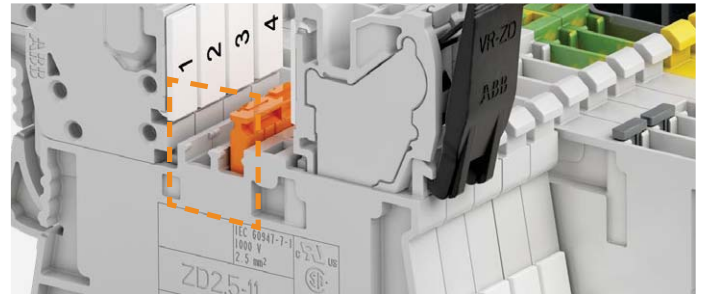

Closed jumper location for stiffness

Smart accessories

Flexible test solutions from individual insulated test adapter to test connectors for complete assemblies testing.

- Direct plug-in into jumpers channels
- 5, 6, 8 mm spacing, mixing various spacing is possible
- 1000 V rating.

Smart plug-in jumpers

Pre-cut poles removable by hand: clean cut.

Insulated up to 1000 V (avoid use of separators).

Predefined shapes in molding to easily identify connected poles with a pen.



Plug-in individual test adapter

Plug-in test connector

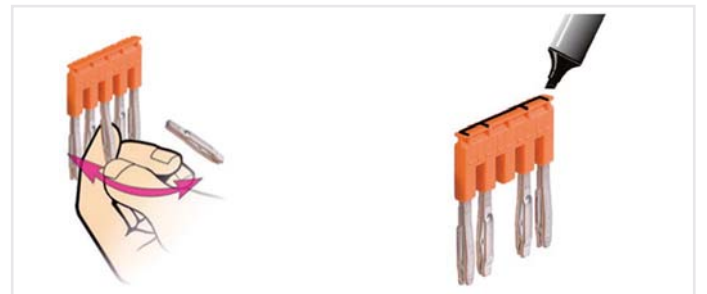

Pre-cut poles easy removable by hand

Predefined shape to identify connected poles

Pluggable technology - SNK series, terminal blocks

Features and benefits

Optimized logistics

Reduce your accessories inventory by up to 50%

SNK PI-Spring, screw and pluggable ranges share the same accessories.

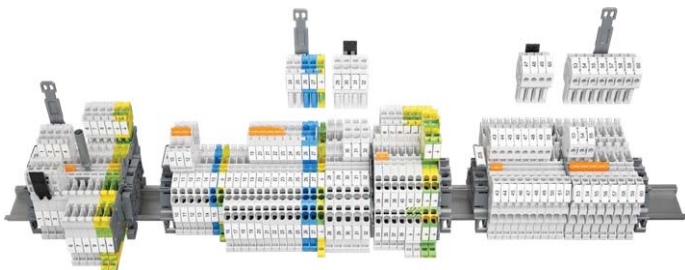

Shared accessories for SNK PI-Spring, screw and pluggable ranges

Facilitate maintenance operations

Terminal blocks can be individually removed from a terminal assembly equipped with markers: TE Connectivity markers become independent after strip mounting. The markers remain on terminal in any situation.

Markers are interchangeable: the smaller marker can fit any bigger block.



Maintenance operations facilitated

Reliable in harsh conditions

Qualified for worldwide markets, applications and for severe environments: vibration, shock, corrosion...



SNK series, terminal blocks

Pluggable technology - Range overview from 2.5 to 4 mm² - 12 to 10 AWG

PI-Spring pluggable

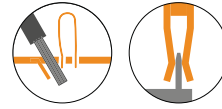

Pluggable pluggable

2

Connections
Single deck
Feed-through

4

Connections
Single deck
Feed-through
Ground

2

Connections
Single deck
Feed-through
Ground

3

Connections
Single deck
Feed-through

4

Connections
Single deck
Feed-through
Ground

Plugs

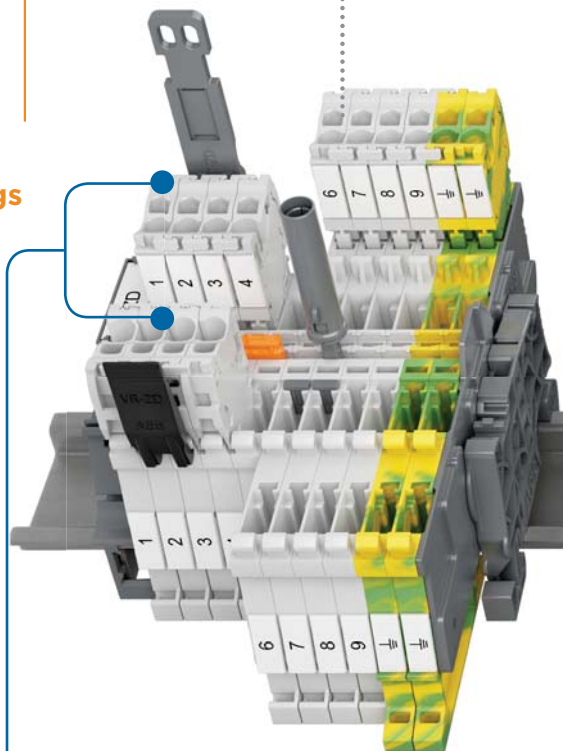

Jumper plugs

Plugs with 1 or 2 connection & jumper to ease potential distribution

Compact plug

Save up to 15% in height

Reduced plug variants

Only two plugs variants to create assemblies

Voltage test

Screwdriver entry point accepts category II probes

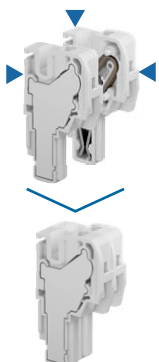

2x2

Connections

Double deck
Feed-through
Ground

Screw clamp pluggable

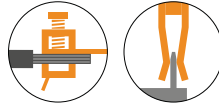

4

Connections

Single deck
Feed-through

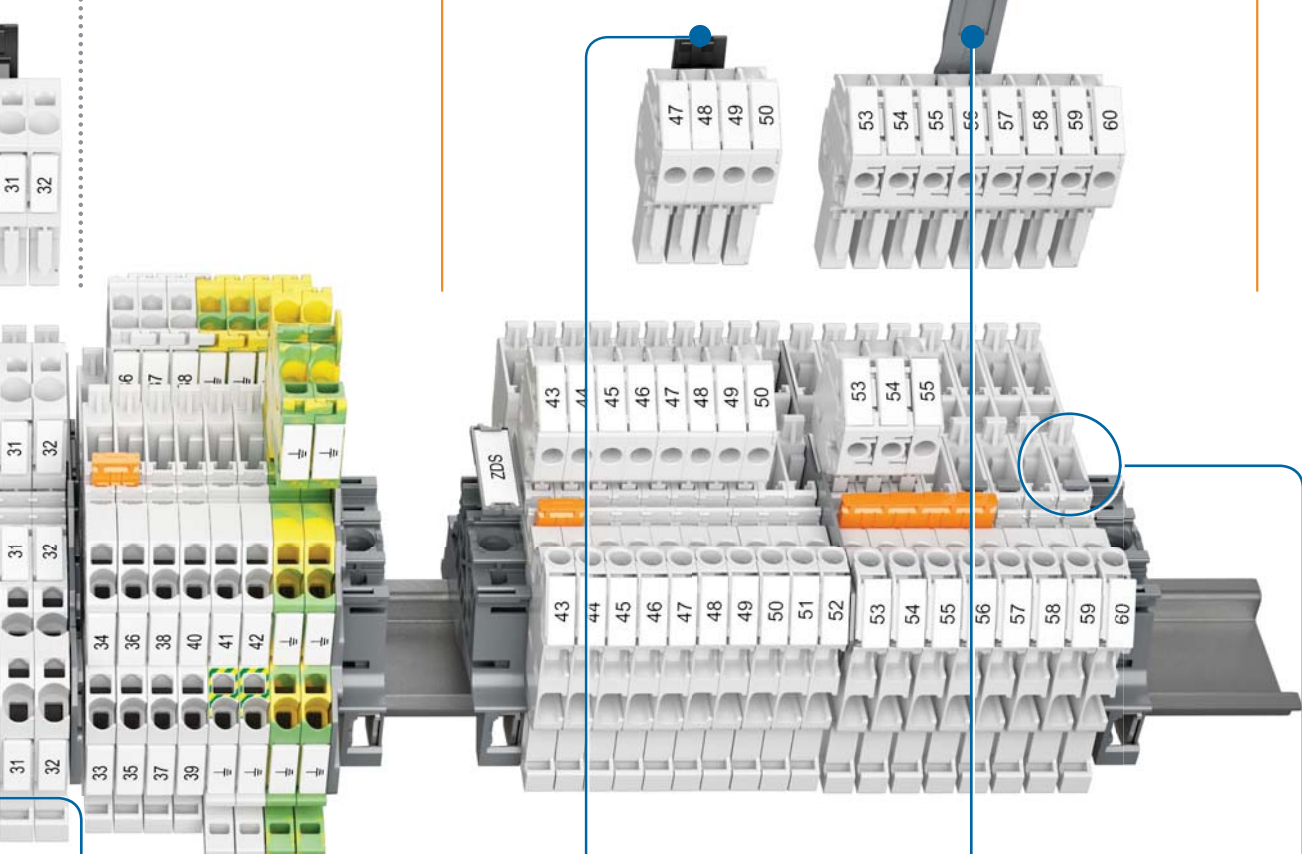

End section

No need of end section between 2.5 and 4 mm² terminal blocks



Locking device

Secure plug and wiring against accidental pulling

Cable clamp

Secure the wires onto the plug when pulling the plug assembly

Convenient coding pegs

Guarantee error free plugs insertion



SNK series, terminal blocks

Pluggable technology



PI-Spring Pluggable

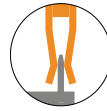

Single deck



Section		Feed-through		Ground	Feed-through		Ground	
2.5 mm ²	12 AWG	ZD2.5-11	ZD2.5-22	ZD2.5-22-PE	ZDK2.5-11	ZDK2.5-21	ZDK2.5-22	ZDK2.5-11-PE
4 mm ²	10 AWG					ZDK4-22		ZDK2.5-22-PE

Double deck



Section		Feed-through	Feed-through + ground	Ground
2.5 mm ²	12 AWG	ZDK2.5-D2	ZDK2.5-D1	ZDK2.5-D2-PE
4 mm ²	10 AWG			ZDK2.5-D1-PE

PI-Spring female plugs



Section		Closed		Closed		Closed		Closed		Closed	
2.5 mm ²	12 AWG	CDK2.5	CDK2.5-E	CDK2.5-J	CDK2.5-J-E	CDK2.5-2P-J	CDK2.5-2P-J-E	CDK2.5-PE	CDK2.5-PE-E	CDK2.5-J-PE	CDK2.5-J-PE-E
4 mm ²	10 AWG	CDK4	CDK4-E								



Screw clamp Pluggable

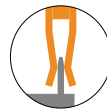

Single deck

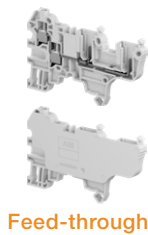

Section		Feed-through
4 mm ²	10 AWG	ZDS4-22 ZDS4-22-R1

Screw clamp female plugs

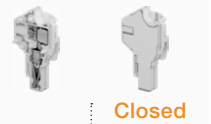

Section		Closed	
4 mm ²	10 AWG	CDS4 CDS4-R1	CDS4-E

clamp -
 Channels for jumpering or testing -
 test socket -
 Blown-fuse indicator -
 male pluggable clamp -
 female pluggable clamp

PI-Spring Pluggable

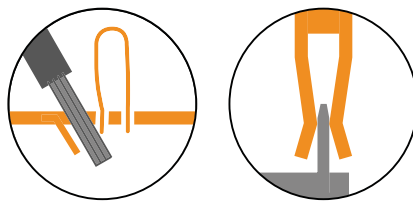

ZD2.5-11 PI-Spring pluggable terminal blocks

Feed-through - 5.2 mm 0.205 in spacing

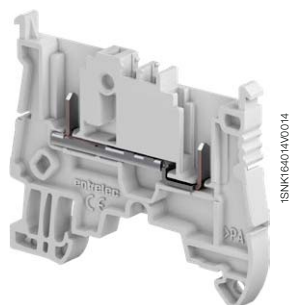

ZD2.5-11

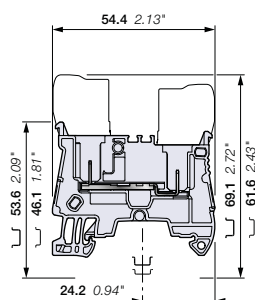

5.2 mm 0.205 in spacing

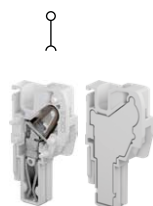

CDK2.5 CDK2.5-E



Description

- Increase your productivity with pluggable terminal blocks: possibility of pre-produced plugs harnesses, time saving plug and play assembly, reduced transportation panels preparation and final installation, easily connect sub-assemblies together,
- Simplify and secure your installation: in site faulty connection errors are eliminated, prior connection testing is eased and reliable, test connectors (TC5) withstanding 10 000 operations are compatible for convenient testing.

Ordering details

Description	Color	Type	Part Number	Pkg qty	Weight (1 pce) g
Feed-through 2 connections	Grey <input type="checkbox"/>	ZD2.5-11	1SNK805016R0000	50	5.66

Main technical data

Connecting capacity	IEC	UL - CSA	Mounting instructions
1 conductor per clamp	Rigid: Solid/Stranded	0.2 ... 4 mm ²	Rail TH 35-7.5, TH 35-15 Wire stripping length 11 mm 0.433 in
	Flexible without ferrule	0.22 ... 2.5 mm ²	
	Flexible with non insulated ferrule	0.22 ... 2.5 mm ²	
	Flexible with insulated ferrule	0.22 ... 2.5 mm ²	
2 conductors per clamp	Flexible with twin ferrule	0.22 ... 0.5 mm ²	Tool (for flexible conductor without ferrule) Ø 3.5 mm Ø 0.138 in
Rated current / Rated cross section		22 A / 2.5 mm ²	20 A / 12 AWG
Rated short-time withstand current (1s)		300 A	
Rated voltage		1000 V	600 V
Impulse withstand voltage		8000 V	
Protection		IP20	NEMA 1

The connecting capacity data for one Rigid: Solid/Stranded, or one Flexible conductor (when applicable) is a mandatory information required by IEC, UL and CSA standards (Copper conductors). All other data are provided as supplementary information only. For more details, please consult our CB, UL or CSA certificates and technical datasheet available on <http://www.TE.com>



Female plugs

Description	Color	Type	Part Number	Pkg qty	Weight (1 pce) g
Female plugs 1 pole	Grey <input type="checkbox"/>	CDK2.5	1SNK805712R0000	50	2.80
Female plugs without outer nubs - Closed 15 poles max.		CDK2.5-E	1SNK805713R0000	50	2.88

Accessories

Description	Color	Type	Part Number	Pkg qty	Weight (1 pce) g	
1 End stops 5.2 mm 0.205 in	Dark grey <input type="checkbox"/>	BAZ1	1SNK900002R0000	50	5.30	
2 End sections 1.5 mm 0.059 in	Dark grey <input type="checkbox"/>	EDK2.5-11	1SNK805915R0000	20	1.49	
3 Jumper bars 2 poles 32 A (IEC)	Orange <input type="checkbox"/>	JB5-2	1SNK905302R0000	50	1.30	
		3 poles 32 A (IEC)	JB5-3	1SNK905303R0000	50	2.00
		4 poles 32 A (IEC)	JB5-4	1SNK905304R0000	50	2.70
		5 poles 32 A (IEC)	JB5-5	1SNK905305R0000	50	3.50
		10 poles 32 A (IEC)	JB5-10	1SNK905310R0000	30	7.10
50 poles 32 A (IEC)		JB5-50	1SNK905350R0000	10	36.00	
4 Cross spacing jumpers 3 poles 32 A (IEC)	Orange <input type="checkbox"/>	JB85-3	1SNK900603R0000	10	2.80	
5 Circuit separators 3 mm 0.118 in	Dark grey <input type="checkbox"/>	CS-R2	1SNK900106R0000	20	3.80	
6 Test adapters For test plugs DIA 2 mm 0.079 in	Dark grey <input type="checkbox"/>	TP2	1SNK900203R0000	20	1.70	
		TP4	1SNK900205R0000	20	2.40	
7 Test connectors 5.2 mm 0.205 in spacing	Dark grey <input type="checkbox"/>	TC5	1SNK900200R0000	10	5.20	
		TC5-R1	1SNK900201R0000	10	5.20	
8 Coding pegs End module, 5.2 mm 0.205 in	Dark grey <input type="checkbox"/>	COP-ZD	1SNK900636R0000	10	3.57	
9 Terminal block markers	White <input type="checkbox"/>	MC512	1SNK140000R0000	22	9.00	
		MC512PA	1SNK149999R0000	20	10.00	
		MG-CPM 13 41790	1SNB041790R0512	1960	0.236	
Universal wire markers holder	Grey <input type="checkbox"/>	UMH	1SNK900611R0000	10	0.20	

Complete list of accessories is indicated in the terminal block datasheet including end stops. Some accessories such as jumper bars may modify the terminal block's ratings: Complete information available in the accessories section of the catalog.

Technical data valid for copper conductors only.

ZD2.5-22 PI-Spring pluggable terminal blocks

Feed-through - 5.2 mm 0.205 in spacing

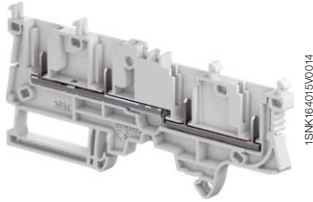

1SNK805017R0000

ZD2.5-22

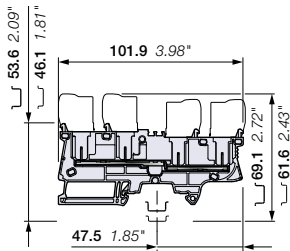

5.2 mm 0.205 in spacing



CDK2.5 CDK2.5-E

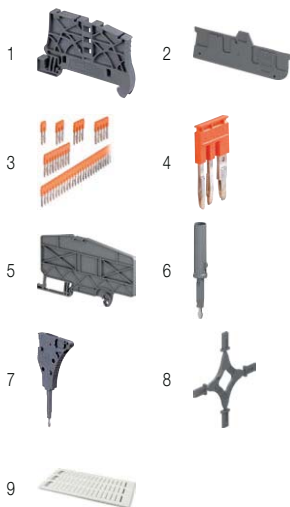

9

Description

- Increase your productivity with pluggable terminal blocks: possibility of pre-produced plugs harnesses, time saving plug and play assembly, reduced transportation panels preparation and final installation, easily connect sub-assemblies together,
- Simplify and secure your installation: in site faulty connection errors are eliminated, prior connection testing is eased and reliable, test connectors (TC5) withstanding 10 000 operations are compatible for convenient testing.

Ordering details

Description	Color	Type	Part Number	Pkg qty	Weight (1 pce) g
Feed-through 4 connections	Grey <input type="checkbox"/>	ZD2.5-22	1SNK805017R0000	50	12.00

Main technical data

Connecting capacity	IEC	UL - CSA	Rail	TH 35-7.5, TH 35-15
1 conductor per clamp	Rigid: Solid/Stranded	0.2 ... 4 mm ²	26 ... 12 AWG	
	Flexible without ferrule	0.22 ... 2.5 mm ²		
	Flexible with non insulated ferrule	0.22 ... 2.5 mm ²	26 ... 14 AWG	
	Flexible with insulated ferrule	0.22 ... 2.5 mm ²	26 ... 14 AWG	
2 conductors per clamp	Flexible with twin ferrule	0.22 ... 0.5 mm ²	26 ... 20 AWG	
Rated current / Rated cross section	22 A / 2.5 mm ²	20 A / 12 AWG		
Rated short-time withstand current (1s)	300 A			
Rated voltage	1000 V	600 V		
Impulse withstand voltage	8000 V			
Protection	IP20	NEMA 1		

Mounting instructions

Wire stripping length	Tool (for flexible conductor without ferrule)	Flat screwdriver
11 mm 0.433 in	Ø 3.5 mm Ø 0.138 in	

The connecting capacity data for one Rigid: Solid/Stranded, or one Flexible conductor (when applicable) is a mandatory information required by IEC, UL and CSA standards (Copper conductors). All other data are provided as supplementary information only. For more details, please consult our CB, UL or CSA certificates and technical datasheet available on <http://www.TE.com>



Female plugs

Description	Color	Type	Part Number	Pkg qty	Weight (1 pce) g
Female plugs 1 pole	Grey <input type="checkbox"/>	CDK2.5	1SNK805712R0000	50	2.80
Female plugs without outer nubs - Closed 15 poles max.		CDK2.5-E	1SNK805713R0000	50	2.88

Accessories

Description	Color	Type	Part Number	Pkg qty	Weight (1 pce) g	
1 End stops 5.2 mm 0.205 in	Dark grey <input type="checkbox"/>	BAZ1	1SNK900002R0000	50	5.30	
2 End sections 2.0 mm 0.079 in	Dark grey <input type="checkbox"/>	ED2.5-22	1SNK805917R0000	20	3.64	
3 Jumper bars	Orange <input type="checkbox"/>	2 poles 32 A (IEC)	JB5-2	1SNK905302R0000	50	1.30
		3 poles 32 A (IEC)	JB5-3	1SNK905303R0000	50	2.00
		4 poles 32 A (IEC)	JB5-4	1SNK905304R0000	50	2.70
		5 poles 32 A (IEC)	JB5-5	1SNK905305R0000	50	3.50
		10 poles 32 A (IEC)	JB5-10	1SNK905310R0000	30	7.10
		50 poles 32 A (IEC)	JB5-50	1SNK905350R0000	10	36.00
4 Cross spacing jumpers 3 poles 32 A (IEC)	Orange <input type="checkbox"/>	JB85-3	1SNK900603R0000	10	2.80	
5 Circuit separators 3 mm 0.118 in	Dark grey <input type="checkbox"/>	CS-R3	1SNK900107R0000	20	6.40	
6 Test adapters	Dark grey <input type="checkbox"/>	For test plugs DIA 2 mm 0.079 in	TP2	1SNK900203R0000	20	1.70
		For test plugs DIA 4 mm 0.157 in	TP4	1SNK900205R0000	20	2.40
7 Test connectors	Dark grey <input type="checkbox"/>	5.2 mm 0.205 in spacing	TC5	1SNK900200R0000	10	5.20
		End module, 5.2 mm 0.205 in	TC5-R1	1SNK900201R0000	10	5.20
8 Coding pegs	Dark grey <input type="checkbox"/>	COP-ZD	1SNK900636R0000	10	3.57	
9 Terminal block markers	White <input type="checkbox"/>	Blank card	MC512	1SNK140000R0000	22	9.00
		Blank marker	MG-CPM 13 41790	1SNB041790R0512	1960	0.236
		Universal wire markers holder	UMH	1SNK900611R0000	10	0.20

Complete list of accessories is indicated in the terminal block datasheet including end stops. Some accessories such as jumper bars may modify the terminal block's ratings: Complete information available in the accessories section of the catalog.

Technical data valid for copper conductors only.

1SNK16402150201

ZD2.5-22-PE PI-Spring pluggable terminal blocks

Ground - 5.2 mm 0.205 in spacing



ZD2.5-22-PE

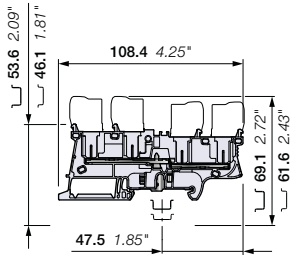

5.2 mm 0.205 in spacing



Available in Q3.2019

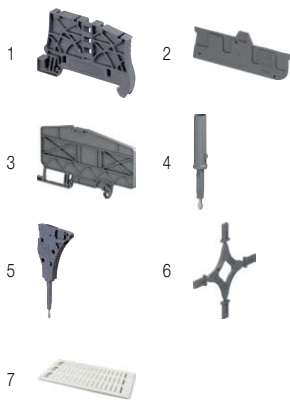

Description

- Increase your productivity with pluggable terminal blocks: possibility of pre-produced plugs harnesses, time saving plug and play assembly, reduced transportation panels preparation and final installation, easily connect sub-assemblies together,
- Simplify and secure your installation: in site faulty connection errors are eliminated, prior connection testing is eased and reliable, test connectors (TC5) withstanding 10 000 operations are compatible for convenient testing.

Ordering details

Description	Color	Type	Part Number	Pkg qty	Weight (1 pce) g
Ground 4 connections	Green-yellow	ZD2.5-22-PE	1SNK805156R0000	50	14.80

Main technical data

Connecting capacity	IEC	UL - CSA	Mounting instructions		
1 conductor per clamp	Rigid: Solid/Stranded	0.2 ... 4 mm ²	26 ... 12 AWG	Rail	TH 35-7.5, TH 35-15
	Flexible without ferrule	0.22 ... 2.5 mm ²		Wire stripping length	11 mm 0.433 in
	Flexible with non insulated ferrule	0.22 ... 2.5 mm ²	26 ... 14 AWG		Tool (for flexible conductor without ferrule)
	Flexible with insulated ferrule	0.22 ... 2.5 mm ²	26 ... 14 AWG		
Rated cross section	2.5 mm ²	12 AWG			
Rated short-time withstand current (1s)	300 A	396 A			
Protection	IP20	NEMA 1			

The connecting capacity data for one Rigid: Solid/Stranded, or one Flexible conductor (when applicable) is a mandatory information required by IEC, UL and CSA standards (Copper conductors). All other data are provided as supplementary information only. For more details, please consult our CB, UL or CSA certificates and technical datasheet available on <http://www.TE.com>



Female plugs

Description	Color	Type	Part Number	Pkg qty	Weight (1 pce) g
Female plugs 1 pole	Green-yellow	CDK2.5-PE	1SNK805750R0000	50	2.80
Female plugs without outer nubs - Closed 15 poles max.		CDK2.5-PE-E	1SNK805753R0000	50	2.88

Accessories

Description	Color	Type	Part Number	Pkg qty	Weight (1 pce) g	
1 End stops 5.2 mm 0.205 in	Dark grey	BAZ1	1SNK900002R0000	50	5.30	
2 End sections 2.0 mm 0.079 in	Dark grey	ED2.5-22	1SNK805917R0000	20	3.64	
3 Circuit separators 3 mm 0.118 in	Dark grey	CS-R3	1SNK900107R0000	20	6.40	
4 Test adapters	Dark grey	For test plugs DIA 2 mm 0.079 in	TP2	1SNK900203R0000	20	1.70
		For test plugs DIA 4 mm 0.157 in	TP4	1SNK900205R0000	20	2.40
5 Test connectors 5.2 mm 0.205 in spacing	Dark grey	End module, 5.2 mm 0.205 in	TC5	1SNK900200R0000	10	5.20
			TC5-R1	1SNK900201R0000	10	5.20
6 Coding pegs	Dark grey	COP-ZD	1SNK900636R0000	10	3.57	
7 Terminal block markers	White	Blank card	MC512	1SNK140000R0000	22	9.00
			MC512PA	1SNK149999R0000	20	10.00
		Blank marker	MG-CPM 13 41790	1SNB041790R0512	1960	0.236
		Universal wire markers holder	Grey	UMH	1SNK900611R0000	10

Complete list of accessories is indicated in the terminal block datasheet including end stops. Some accessories such as jumper bars may modify the terminal block's ratings: Complete information available in the accessories section of the catalog.

Technical data valid for copper conductors only.

ZDK2.5-11 PI-Spring pluggable terminal blocks

Feed-through - 5.2 mm 0.205 in spacing

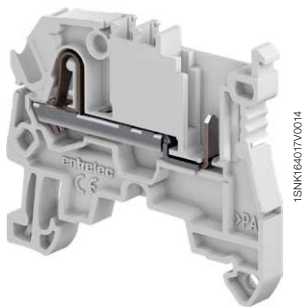

ZDK2.5-11

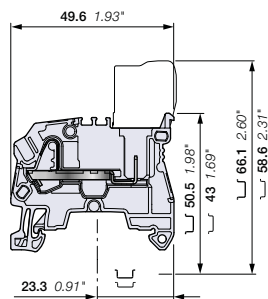

5.2 mm 0.205 in spacing

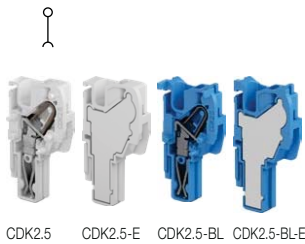

CDK2.5 CDK2.5-E CDK2.5-BL CDK2.5-BL-E

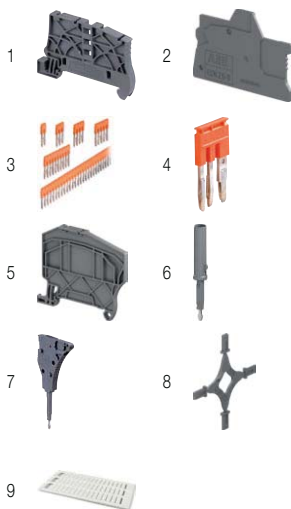

Description

- Increase your productivity with pluggable terminal blocks: possibility of pre-produced plugs harnesses, time saving plug and play assembly, reduced transportation panels preparation and final installation, easily connect sub-assemblies together,
- Simplify and secure your installation: in site faulty connection errors are eliminated, prior connection testing is eased and reliable, test connectors (TC5) withstanding 10 000 operations are compatible for convenient testing.

Ordering details

Description	Color	Type	Part Number	Pkg qty	Weight (1 pce) g
Feed-through 2 connections	Grey <input type="checkbox"/>	ZDK2.5-11	1SNK805015R0000	50	7.00
	Blue <input type="checkbox"/>	ZDK2.5-11-BL	1SNK805025R0000	50	7.00

Main technical data

Connecting capacity	IEC	UL - CSA	Mounting instructions
1 conductor per clamp	Rigid: Solid/Stranded	0.2 ... 4 mm ²	26 ... 12 AWG
	Flexible without ferrule	0.22 ... 2.5 mm ²	26 ... 14 AWG
	Flexible with non insulated ferrule	0.22 ... 2.5 mm ²	26 ... 14 AWG
	Flexible with insulated ferrule	0.22 ... 2.5 mm ²	26 ... 14 AWG
2 conductors per clamp	Flexible with twin ferrule	0.22 ... 0.5 mm ²	26 ... 20 AWG
Rated current / Rated cross section	24 A / 2.5 mm ²	20 A / 12 AWG	
Rated short-time withstand current (1s)	300 A		
Rated voltage	1000 V	600 V	
Impulse withstand voltage	8000 V		
Protection	IP20	NEMA 1	

The connecting capacity data for one Rigid: Solid/Stranded, or one Flexible conductor (when applicable) is a mandatory information required by IEC, UL and CSA standards (Copper conductors). All other data are provided as supplementary information only. For more details, please consult our CB, UL or CSA certificates and technical datasheet available on <http://www.TE.com>



Female plugs

Description	Color	Type	Part Number	Pkg qty	Weight (1 pce) g
Female plugs 1 pole	Grey <input type="checkbox"/>	CDK2.5	1SNK805712R0000	50	2.80
Female plugs without outer nubs - Closed		CDK2.5-E	1SNK805713R0000	50	2.88
Female plugs 1 pole	Blue <input type="checkbox"/>	CDK2.5-BL	1SNK805742R0000	50	2.80
Female plugs without outer nubs - Closed		CDK2.5-BL-E	1SNK805743R0000	50	2.88

15 poles max.

Accessories

Description	Color	Type	Part Number	Pkg qty	Weight (1 pce) g	
1 End stops 5.2 mm 0.205 in	Dark grey <input type="checkbox"/>	BAZ1	1SNK900002R0000	50	5.30	
2 End sections 1.5 mm 0.059 in	Dark grey <input type="checkbox"/>	EDK2.5-11	1SNK805915R0000	20	1.49	
3 Jumper bars	Orange <input type="checkbox"/>	2 poles 32 A (IEC)	JB5-2	1SNK905302R0000	50	1.30
		3 poles 32 A (IEC)	JB5-3	1SNK905303R0000	50	2.00
		4 poles 32 A (IEC)	JB5-4	1SNK905304R0000	50	2.70
		5 poles 32 A (IEC)	JB5-5	1SNK905305R0000	50	3.50
		10 poles 32 A (IEC)	JB5-10	1SNK905310R0000	30	7.10
		50 poles 32 A (IEC)	JB5-50	1SNK905350R0000	10	36.00
4 Cross spacing jumpers 3 poles 32 A (IEC)	Orange <input type="checkbox"/>	JB85-3	1SNK900603R0000	10	2.80	
5 Circuit separators 3 mm 0.118 in	Dark grey <input type="checkbox"/>	CS-R2	1SNK900106R0000	20	3.80	
6 Test adapters	Dark grey <input type="checkbox"/>	For test plugs DIA 2 mm 0.079 in	TP2	1SNK900203R0000	20	1.70
		For test plugs DIA 4 mm 0.157 in	TP4	1SNK900205R0000	20	2.40
7 Test connectors	Dark grey <input type="checkbox"/>	5.2 mm 0.205 in spacing	TC5	1SNK900200R0000	10	5.20
		End module, 5.2 mm 0.205 in	TC5-R1	1SNK900201R0000	10	5.20
8 Coding pegs	Dark grey <input type="checkbox"/>	COP-ZD	1SNK900636R0000	10	3.57	
9 Terminal block markers	White <input type="checkbox"/>	MC512	1SNK140000R0000	22	9.00	
		MC512PA	1SNK149999R0000	20	10.00	
		Blank marker	MG-CPM 13 41790	1SNB041790R0512	1960	0.236
	Grey <input type="checkbox"/>	UMH	1SNK900611R0000	10	0.20	

Complete list of accessories is indicated in the terminal block datasheet including end stops.

Some accessories such as jumper bars may modify the terminal block's ratings: Complete information available in the accessories section of the catalog.

Technical data valid for copper conductors only.

1SNK1640235/0201

ZDK2.5-21 PI-Spring pluggable terminal blocks

Feed-through - 5.2 mm 0.205 in spacing

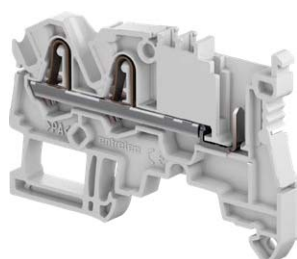

1SNK164020V0014

ZDK2.5-21

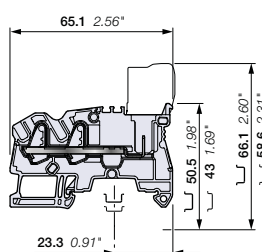

5.2 mm 0.205 in spacing



CDK2.5 CDK2.5-E



Description

- Increase your productivity with pluggable terminal blocks: possibility of pre-produced plugs harnesses, time saving plug and play assembly, reduced transportation panels preparation and final installation, easily connect sub-assemblies together,
- Simplify and secure your installation: in site faulty connection errors are eliminated, prior connection testing is eased and reliable, test connectors (TC5) withstanding 10 000 operations are compatible for convenient testing.

Ordering details

Description	Color	Type	Part Number	Pkg qty	Weight (1 pce) g
Feed-through 3 connections	Grey	ZDK2.5-21	1SNK805014R0000	50	7.47

Main technical data

Connecting capacity	IEC	UL - CSA	Mounting instructions
1 conductor per clamp	Rigid: Solid/Stranded Flexible without ferrule Flexible with non insulated ferrule Flexible with insulated ferrule	0.2 ... 4 mm ² 0.22 ... 2.5 mm ² 0.22 ... 2.5 mm ² 0.22 ... 2.5 mm ²	26 ... 12 AWG 26 ... 14 AWG 26 ... 14 AWG 26 ... 14 AWG
2 conductors per clamp	Flexible with twin ferrule	0.22 ... 0.5 mm ²	26 ... 20 AWG
Rated current / Rated cross section	24 A / 2.5 mm ²	20 A / 12 AWG	Wire stripping length
Rated short-time withstand current (1s)	300 A		Tool (for flexible conductor without ferrule)
Rated voltage	1000 V	600 V	Flat screwdriver
Impulse withstand voltage	8000 V		Ø 3.5 mm
Protection	IP20	NEMA 1	Ø 0.138 in

The connecting capacity data for one Rigid: Solid/Stranded, or one Flexible conductor (when applicable) is a mandatory information required by IEC, UL and CSA standards (Copper conductors). All other data are provided as supplementary information only. For more details, please consult our CB, UL or CSA certificates and technical datasheet available on <http://www.TE.com>

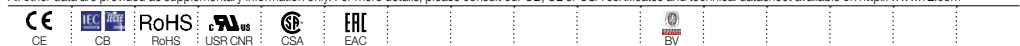

Female plugs

Description	Color	Type	Part Number	Pkg qty	Weight (1 pce) g
Female plugs 1 pole	Grey	CDK2.5	1SNK805712R0000	50	2.80
Female plugs without outer nubs - Closed 15 poles max.		CDK2.5-E	1SNK805713R0000	50	2.88

Accessories

Description	Color	Type	Part Number	Pkg qty	Weight (1 pce) g
1 End stops 5.2 mm 0.205 in	Dark grey	BAZ1	1SNK900002R0000	50	5.30
2 End sections 1.5 mm 0.059 in	Dark grey	EDK2.5-21	1SNK805914R0000	20	1.90
3 Jumper bars 2 poles 32 A (IEC)	Orange	JB5-2	1SNK905302R0000	50	1.30
3 poles 32 A (IEC)		JB5-3	1SNK905303R0000	50	2.00
4 poles 32 A (IEC)		JB5-4	1SNK905304R0000	50	2.70
5 poles 32 A (IEC)		JB5-5	1SNK905305R0000	50	3.50
10 poles 32 A (IEC)		JB5-10	1SNK905310R0000	30	7.10
50 poles 32 A (IEC)		JB5-50	1SNK905350R0000	10	36.00
4 Cross spacing jumpers 3 poles 32 A (IEC)	Orange	JB85-3	1SNK900603R0000	10	2.80
5 Circuit separators 3 mm 0.118 in	Dark grey	CS-R3	1SNK900107R0000	20	6.40
6 Test adapters For test plugs DIA 2 mm 0.079 in	Dark grey	TP2	1SNK900203R0000	20	1.70
For test plugs DIA 4 mm 0.157 in		TP4	1SNK900205R0000	20	2.40
7 Test connectors 5.2 mm 0.205 in spacing	Dark grey	TC5	1SNK900200R0000	10	5.20
End module, 5.2 mm 0.205 in		TC5-R1	1SNK900201R0000	10	5.20
8 Coding pegs	Dark grey	COP-ZD	1SNK900636R0000	10	3.57
9 Terminal block markers Blank card	White	MC512	1SNK140000R0000	22	9.00
Blank marker		MG-CPM 13 41790	1SNB041790R0512	1960	0.236
Universal wire markers holder	Grey	UMH	1SNK900611R0000	10	0.20

Complete list of accessories is indicated in the terminal block datasheet including end stops. Some accessories such as jumper bars may modify the terminal block's ratings: Complete information available in the accessories section of the catalog.

Technical data valid for copper conductors only.

ZDK2.5-22 PI-Spring pluggable terminal blocks

Feed-through - 5.2 mm 0.205 in spacing

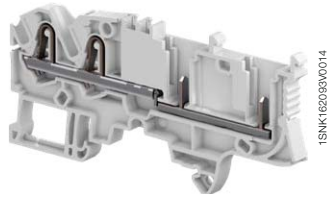

ZDK2.5-22

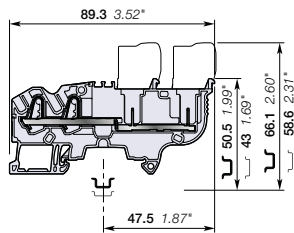

5.2 mm 0.205 in spacing

Description

- Increase your productivity with pluggable terminal blocks: possibility of pre-produced plugs harnesses, time saving plug and play assembly, reduced transportation panels preparation and final installation, easily connect sub-assemblies together,
- Simplify and secure your installation: in site faulty connection errors are eliminated, prior connection testing is eased and reliable, test connectors (TC5) withstanding 10 000 operations are compatible for convenient testing.

Ordering details

Description	Color	Type	Part number	Pkg qty	Weight (1 pce) g
Feed-through 4 connections	Grey <input type="checkbox"/>	ZDK2.5-22	1SNK805010R0000	50	9.60
Feed-through 4 connections	Blue <input type="checkbox"/>	ZDK2.5-22-BL	1SNK805020R0000	50	9.60

Main technical data

Connecting capacity	IEC	UL - CSA	Mounting instructions
1 conductor per clamp	Rigid: Solid/Stranded	0.2 ... 4 mm ²	26 ... 12 AWG
	Flexible without ferrule	0.22 ... 2.5 mm ²	26 ... 14 AWG
	Flexible with non insulated ferrule	0.22 ... 2.5 mm ²	26 ... 14 AWG
	Flexible with insulated ferrule	0.22 ... 2.5 mm ²	26 ... 14 AWG
2 conductors per clamp	Flexible with twin ferrule	0.22 ... 0.5 mm ²	26 ... 20 AWG
Rated current / Rated cross section		24 A / 2.5 mm ²	22 A / 12 AWG
Rated short-time withstand current (1s)		300 A	
Rated voltage		1000 V	600 V
Impulse withstand voltage		8000 V	
Protection		IP20	NEMA 1

The connecting capacity data for one Rigid: Solid/Stranded, or one Flexible conductor (when applicable) is a mandatory information required by IEC, UL and CSA standards (Copper conductors). All other data are provided as supplementary information only. For more details, please consult our CB, UL or CSA certificates and technical datasheet available on <http://www.TE.com>

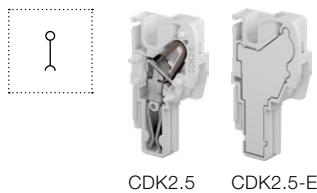

CDK2.5 CDK2.5-E

Female plugs

Description	Color	Type	Part number	Pkg qty	Weight (1 pce) g
Female plugs 1 pole	Grey <input type="checkbox"/>	CDK2.5	1SNK805712R0000	50	2.80
Female plugs without outer nubs - Closed 15 poles max.		CDK2.5-E	1SNK805713R0000	50	2.80



Accessories

Description	Color	Type	Part number	Pkg qty	Weight (1 pce) g	
1 End stops 5.2 mm 0.205 in	Dark grey <input type="checkbox"/>	BAZ1	1SNK900002R0000	50	5.30	
2 End sections 2.2 mm 0.087 in	Dark grey <input type="checkbox"/>	EDK2.5-22	1SNK805910R0000	20	3.15	
3 Jumper bars	Orange <input type="checkbox"/>	2 poles 32 A (IEC)	JB5-2	1SNK905302R0000	50	1.30
		3 poles 32 A (IEC)	JB5-3	1SNK905303R0000	50	2.00
		4 poles 32 A (IEC)	JB5-4	1SNK905304R0000	50	2.70
		5 poles 32 A (IEC)	JB5-5	1SNK905305R0000	50	3.50
		10 poles 32 A (IEC)	JB5-10	1SNK905310R0000	30	7.10
		50 poles 32 A (IEC)	JB5-50	1SNK905350R0000	10	36.00
4 Cross spacing jumpers 3 poles 32 A (IEC)	Orange <input type="checkbox"/>	JB85-3	1SNK900603R0000	10	2.80	
5 Circuit separators 3 mm 0.118 in	Dark grey <input type="checkbox"/>	CS-R3	1SNK900107R0000	20	6.40	
6 Test adapters	Dark grey <input type="checkbox"/>	For test plugs DIA 2 mm 0.079 in	TP2	1SNK900203R0000	20	1.70
		For test plugs DIA 4 mm 0.157 in	TP4	1SNK900205R0000	20	2.40
		5.2 mm 0.205 in spacing	TC5	1SNK900200R0000	10	5.20
7 Test connectors	Dark grey <input type="checkbox"/>	End module, 5.2 mm 0.205 in	TC5-R1	1SNK900201R0000	10	5.20
			COP-ZD	1SNK900636R0000	10	3.57
8 Coding pegs	Dark grey <input type="checkbox"/>		MG-CPM 13 41790	1960	0.23	
			MC512	1SNK140000R0000	22	9.00
			MC512PA	1SNK149999R0000	20	10.00
9 Terminal block markers	Grey <input type="checkbox"/>	UMH	1SNK900611R0000	10	0.20	

Complete list of accessories is indicated in the terminal block datasheet including end stops.

Some accessories such as jumper bars may modify the terminal block's ratings: Complete information available in the accessories section of the catalog.

Technical data valid for copper conductors only.

ZDK4-22 PI-Spring pluggable terminal blocks

Feed-through - 6 mm 0.236 in spacing



ZDK4-22

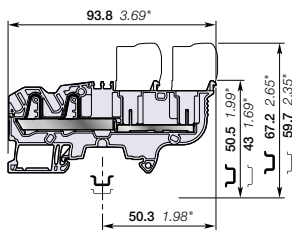

6 mm 0.236 in spacing

Description

- Increase your productivity with pluggable terminal blocks: possibility of pre-produced plugs harnesses, time saving plug and play assembly, reduced transportation panels preparation and final installation, easily connect sub-assemblies together,
- Simplify and secure your installation: in site faulty connection errors are eliminated, prior connection testing is eased and reliable, test connectors (TC5-R1 + ES-TC6) withstanding 10 000 operations are compatible for convenient testing.

Ordering details

Description	Color	Type	Part Number	Pkg qty	Weight (1 pce) g
Feed-through 4 connections	Grey <input type="checkbox"/>	ZDK4-22	1SNK806010R0000	50	14.30

Main technical data

Connecting capacity		IEC	UL - CSA	Mounting instructions	
1 conductor per clamp	Rigid: Solid/Stranded	0.5 ... 6 mm ²	26 ... 10 AWG	Rail	TH 35-7.5, TH 35-15
	Flexible without ferrule	0.5 ... 4 mm ²	26 ... 10 AWG	Wire stripping length	12.5 mm 0.492 in
	Flexible with non insulated ferrule	0.5 ... 4 mm ²	26 ... 12 AWG	Tool (for flexible conductor without ferrule)	Flat screwdriver Ø 3.5 mm Ø 0.138 in
	Flexible with insulated ferrule	0.5 ... 4 mm ²	26 ... 12 AWG		
2 conductors per clamp	Flexible with twin ferrule	0.5 ... 1 mm ²	26 ... 18 AWG		
Rated current / Rated cross section		30 A / 4 mm ²	30 A / 10 AWG		
Rated short-time withstand current (1s)		480 A			
Rated voltage		1000 V	600 V		
Impulse withstand voltage		8000 V			
Protection		IP20	NEMA 1		

The connecting capacity data for one Rigid: Solid/Stranded, or one Flexible conductor (when applicable) is a mandatory information required by IEC, UL and CSA standards (Copper conductors). All other data are provided as supplementary information only. For more details, please consult our CB, UL or CSA certificates and technical datasheet available on <http://www.TE.com>

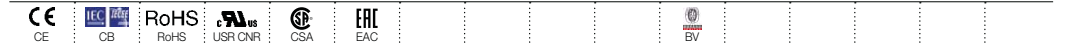

Female plugs

Description	Color	Type	Part Number	Pkg qty	Weight (1 pce) g
Female plugs 1 pole	Grey <input type="checkbox"/>	CDK4	1SNK806712R0000	50	3.80
Female plugs without outer nubs - Closed		CDK4-E	1SNK806713R0000	50	4.50

15 poles max.

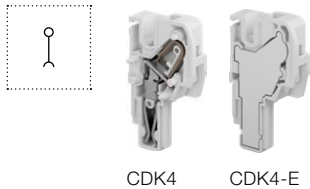

CDK4

CDK4-E

Accessories

Description	Color	Type	Part Number	Pkg qty	Weight (1 pce) g	
1 End stops 5.2 mm 0.205 in	Dark grey <input checked="" type="checkbox"/>	BAZ1	1SNK900002R0000	50	5.30	
2 End sections 2.2 mm 0.087 in	Dark grey <input checked="" type="checkbox"/>	EDK2.5-22	1SNK805910R0000	20	3.15	
3 Jumper bars	Orange <input checked="" type="checkbox"/>	2 poles 41 A (IEC)	JB6-2	1SNK906302R0000	50	1.30
		3 poles 41 A (IEC)	JB6-3	1SNK906303R0000	50	2.10
		4 poles 41 A (IEC)	JB6-4	1SNK906304R0000	50	2.90
		5 poles 41 A (IEC)	JB6-5	1SNK906305R0000	50	3.60
		10 poles 41 A (IEC)	JB6-10	1SNK906310R0000	20	7.40
		50 poles 41 A (IEC)	JB6-50	1SNK906350R0000	10	38.10
4 Cross spacing jumpers 3 poles 32 A (IEC)	Orange <input checked="" type="checkbox"/>	JB85-3	1SNK900603R0000	10	2.80	
5 Circuit separators 3 mm 0.118 in	Dark grey <input checked="" type="checkbox"/>	CS-R3	1SNK900107R0000	20	6.40	
6 Test adapters	Dark grey <input checked="" type="checkbox"/>	For test plugs DIA 2 mm 0.079 in	TP2	1SNK900203R0000	20	1.70
		For test plugs DIA 4 mm 0.157 in	TP4	1SNK900205R0000	20	2.40
7 Test connectors	Dark grey <input checked="" type="checkbox"/>	TC5-R1	1SNK900201R0000	10	5.20	
8 Spacers 0.8 mm 0.031 in	Dark grey <input checked="" type="checkbox"/>	ES-TC6	1SNK900105R0000	10	0.80	
9 Coding pegs	Dark grey <input checked="" type="checkbox"/>	COP-ZD	1SNK900636R0000	10	3.57	
10 Terminal block markers	White <input type="checkbox"/>	Blank marker	MG-CPM 13 41791	1SNB041791R0612	1680	0.27
		Blank card	MC612	1SNK150000R0000	22	10.00
			MC612PA	1SNK159999R0000	20	11.00
	Grey <input type="checkbox"/>	Universal wire markers holder	UMH	1SNK900611R0000	10	0.20

Complete list of accessories is indicated in the terminal block datasheet including end stops.

Some accessories such as jumper bars may modify the terminal block's ratings: Complete information available in the accessories section of the catalog.

Technical data valid for copper conductors only.

ZDK2.5-11-PE PI-Spring pluggable terminal blocks

Ground - 5.2 mm 0.205 in spacing



1SNK16401900014

ZDK2.5-11-PE

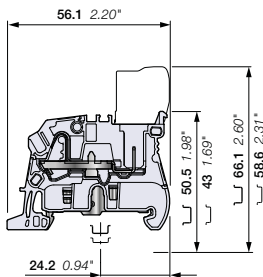

5.2 mm 0.205 in spacing

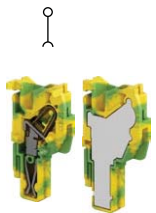

CDK2.5-PE CDK2.5-PE-E

Available in Q3.2019

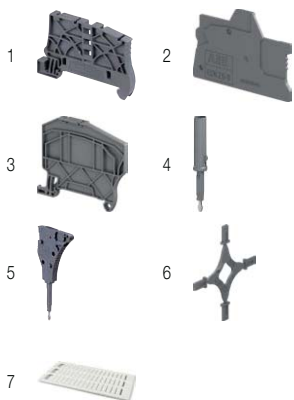

Description

- Increase your productivity with pluggable terminal blocks: possibility of pre-produced plugs harnesses, time saving plug and play assembly, reduced transportation panels preparation and final installation, easily connect sub-assemblies together,
- Simplify and secure your installation: in site faulty connection errors are eliminated, prior connection testing is eased and reliable, test connectors (TC5) withstanding 10 000 operations are compatible for convenient testing.

Ordering details

Description	Color	Type	Part Number	Pkg qty	Weight (1 pce) g
Ground 2 connections	Green-yellow	ZDK2.5-11-PE	1SNK805150R0000	50	9.62

Main technical data

Connecting capacity	IEC	UL - CSA	Mounting instructions
1 conductor per clamp	Rigid: Solid/Stranded	0.2 ... 4 mm²	26 ... 12 AWG
	Flexible without ferrule	0.22 ... 2.5 mm²	26 ... 14 AWG
	Flexible with non insulated ferrule	0.22 ... 2.5 mm²	26 ... 14 AWG
	Flexible with insulated ferrule	0.22 ... 2.5 mm²	26 ... 14 AWG
Rated cross section	2.5 mm²	12 AWG	
Rated short-time withstand current (1s)	300 A	396 A	
Protection	IP20	NEMA 1	

The connecting capacity data for one Rigid: Solid/Stranded, or one Flexible conductor (when applicable) is a mandatory information required by IEC, UL and CSA standards (Copper conductors). All other data are provided as supplementary information only. For more details, please consult our CB, UL or CSA certificates and technical datasheet available on <http://www.TE.com>

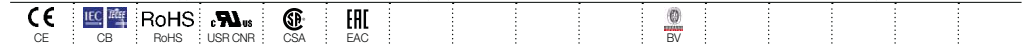

Female plugs

Description	Color	Type	Part Number	Pkg qty	Weight (1 pce) g
Female plugs 1 pole	Green-yellow	CDK2.5-PE	1SNK805750R0000	50	2.80
Female plugs without outer nubs - Closed 15 poles max.		CDK2.5-PE-E	1SNK805753R0000	50	2.88

Accessories

Description	Color	Type	Part Number	Pkg qty	Weight (1 pce) g	
1 End stops 5.2 mm 0.205 in	Dark grey	BAZ1	1SNK900002R0000	50	5.30	
2 End sections 1.5 mm 0.059 in	Dark grey	EDK2.5-11	1SNK805915R0000	20	1.49	
3 Circuit separators 3 mm 0.118 in	Dark grey	CS-R2	1SNK900106R0000	20	3.80	
4 Test adapters	Dark grey	For test plugs DIA 2 mm 0.079 in	TP2	1SNK900203R0000	20	1.70
		For test plugs DIA 4 mm 0.157 in	TP4	1SNK900205R0000	20	2.40
5 Test connectors 5.2 mm 0.205 in spacing	Dark grey	End module, 5.2 mm 0.205 in	TC5	1SNK900200R0000	10	5.20
			TC5-R1	1SNK900201R0000	10	5.20
6 Coding pegs	Dark grey	COP-ZD	1SNK900636R0000	10	3.57	
7 Terminal block markers	White	Blank card	MC512	1SNK140000R0000	22	9.00
		Blank marker	MC512PA	1SNK149999R0000	20	10.00
			MG-CPM 13 41790	1SNB041790R0512	1960	0.236
		Universal wire markers holder	UMH	1SNK900611R0000	10	0.20

Complete list of accessories is indicated in the terminal block datasheet including end stops. Some accessories such as jumper bars may modify the terminal block's ratings: Complete information available in the accessories section of the catalog.

Technical data valid for copper conductors only.

1SNK16402450201

ZDK2.5-22-PE PI-Spring pluggable terminal blocks

Feed-through - 5.2 mm 0.205 in spacing



ZDK2.5-22-PE

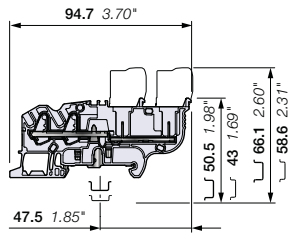

5.2 mm 0.205 in spacing

Description

- Increase your productivity with pluggable terminal blocks: possibility of pre-produced plugs harnesses, time saving plug and play assembly, reduced transportation panels preparation and final installation, easily connect sub-assemblies together,
- Simplify and secure your installation: in site faulty connection errors are eliminated, prior connection testing is eased and reliable, test connectors (TC5) withstanding 10 000 operations are compatible for convenient testing.

Ordering details

Description	Color	Type	Part Number	Pkg qty	Weight (1 pce) g
Ground 4 connections	Green-yellow	ZDK2.5-22-PE	1SNK805152R0000	50	14.05

Main technical data

Connecting capacity	IEC	UL - CSA	Mounting instructions		
1 conductor per clamp	Rigid: Solid/Stranded	0.2 ... 4 mm²	26 ... 12 AWG	Rail	TH 35-7.5, TH 35-15
	Flexible without ferrule	0.22 ... 2.5 mm²	26 ... 14 AWG	Wire stripping length	11 mm 0.433 in
	Flexible with non insulated ferrule	0.22 ... 2.5 mm²	26 ... 14 AWG	Tool (for flexible conductor without ferrule)	Flat screwdriver Ø 3.5 mm Ø 0.138 in
	Flexible with insulated ferrule	0.22 ... 2.5 mm²	26 ... 14 AWG		
Rated cross section	2.5 mm²	12 AWG			
Rated short-time withstand current (1s)	300 A	396 A			
Protection	IP20	NEMA 1			

The connecting capacity data for one Rigid: Solid/Stranded, or one Flexible conductor (when applicable) is a mandatory information required by IEC, UL and CSA standards (Copper conductors). All other data are provided as supplementary information only. For more details, please consult our CB, UL or CSA certificates and technical datasheet available on <http://www.TE.com>

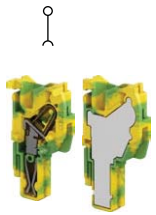
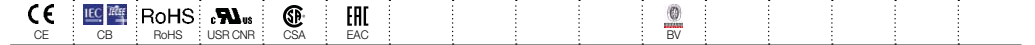

CDK2.5-PE CDK2.5-PE-E

Available in Q3.2019

Female plugs

Description	Color	Type	Part Number	Pkg qty	Weight (1 pce) g
Female plugs 1 pole	Green-yellow	CDK2.5-PE	1SNK805750R0000	50	2.80
Female plugs without outer nubs - Closed 15 poles max.		CDK2.5-PE-E	1SNK805753R0000	50	2.88

Accessories

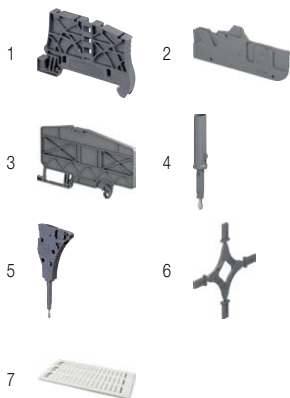

Description	Color	Type	Part Number	Pkg qty	Weight (1 pce) g	
1 End stops 5.2 mm 0.205 in	Dark grey	BAZ1	1SNK900002R0000	50	5.30	
2 End sections 2.2 mm 0.087 in	Dark grey	EDK2.5-22	1SNK805910R0000	20	3.15	
3 Circuit separators 3 mm 0.118 in	Dark grey	CS-R3	1SNK900107R0000	20	6.40	
4 Test adapters	Dark grey	For test plugs DIA 2 mm 0.079 in	TP2	1SNK900203R0000	20	1.70
		For test plugs DIA 4 mm 0.157 in	TP4	1SNK900205R0000	20	2.40
5 Test connectors 5.2 mm 0.205 in spacing	Dark grey	End module, 5.2 mm 0.205 in	TC5	1SNK900200R0000	10	5.20
			TC5-R1	1SNK900201R0000	10	5.20
6 Coding pegs	Dark grey	COP-ZD	1SNK900636R0000	10	3.57	
7 Terminal block markers	White	Blank card	MC512	1SNK140000R0000	22	9.00
			MC512PA	1SNK149999R0000	20	10.00
		Blank marker	MG-CPM 13 41790	1SNB041790R0512	1960	0.236
		Universal wire markers holder	Grey	UMH	1SNK900611R0000	10

Complete list of accessories is indicated in the terminal block datasheet including end stops. Some accessories such as jumper bars may modify the terminal block's ratings: Complete information available in the accessories section of the catalog.

Technical data valid for copper conductors only.

ZDK2.5-D2 PI-Spring pluggable terminal blocks

Double deck feed-through 2 circuits - 5.2 mm 0.205 in spacing

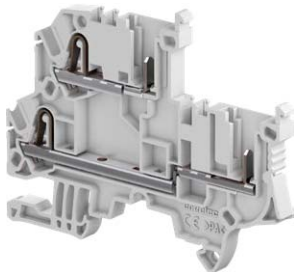

1SNK16402850014

ZDK2.5-D2

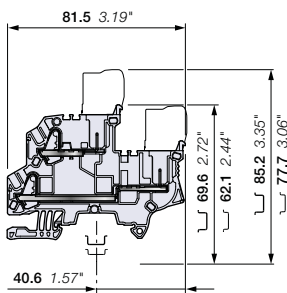

5.2 mm 0.205 in spacing

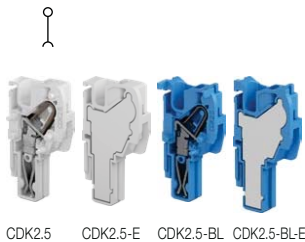

CDK2.5 CDK2.5-E CDK2.5-BL CDK2.5-BL-E

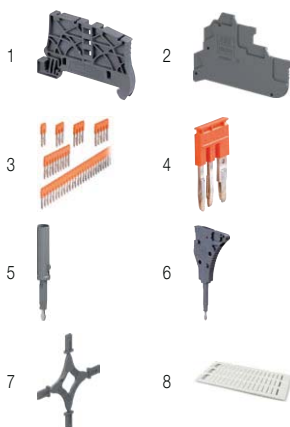

Description

- Increase your productivity with pluggable terminal blocks: possibility of pre-produced plugs harnesses, time saving plug and play assembly, reduced transportation panels preparation and final installation, easily connect sub-assemblies together,
- Simplify and secure your installation: in site faulty connection errors are eliminated, prior connection testing is eased and reliable, test connectors (TC5) withstanding 10 000 operations are compatible for convenient testing.

Ordering details

Description	Color	Type	Part Number	Pkg qty	Weight (1 pce) g
Feed-through double deck 4 connections	Grey <input type="checkbox"/>	ZDK2.5-D2	1SNK805213R0000	50	11.89
	Blue <input type="checkbox"/>	ZDK2.5-D2-BL	1SNK805223R0000	50	11.89

Main technical data

Connecting capacity	IEC	UL - CSA	Mounting instructions
1 conductor per clamp	Rigid: Solid/Stranded	0.2 ... 4 mm ²	26 ... 12 AWG
	Flexible without ferrule	0.22 ... 2.5 mm ²	26 ... 14 AWG
	Flexible with non insulated ferrule	0.22 ... 2.5 mm ²	26 ... 14 AWG
	Flexible with insulated ferrule	0.22 ... 2.5 mm ²	26 ... 14 AWG
2 conductors per clamp	Flexible with twin ferrule	0.22 ... 0.5 mm ²	26 ... 20 AWG
Rated current / Rated cross section	22 A / 2.5 mm ²	20 A / 12 AWG	
Rated short-time withstand current (1s)	300 A		
Rated voltage	800 V	600 V	
Impulse withstand voltage	8000 V		
Protection	IP20	NEMA 1	

The connecting capacity data for one Rigid: Solid/Stranded, or one Flexible conductor (when applicable) is a mandatory information required by IEC, UL and CSA standards (Copper conductors). All other data are provided as supplementary information only. For more details, please consult our CB, UL or CSA certificates and technical datasheet available on <http://www.TE.com>

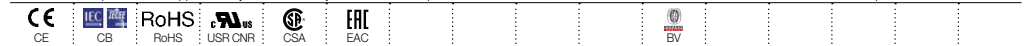

Female plugs

Description	Color	Type	Part Number	Pkg qty	Weight (1 pce) g
Female plugs 1 pole	Grey <input type="checkbox"/>	CDK2.5	1SNK805712R0000	50	2.80
Female plugs without outer nubs - Closed		CDK2.5-E	1SNK805713R0000	50	2.88
Female plugs 1 pole	Blue <input type="checkbox"/>	CDK2.5-BL	1SNK805742R0000	50	2.80
Female plugs without outer nubs - Closed		CDK2.5-BL-E	1SNK805743R0000	50	2.88

15 poles max.

Accessories

Description	Color	Type	Part Number	Pkg qty	Weight (1 pce) g	
1 End stops 5.2 mm 0.205 in	Dark grey <input type="checkbox"/>	BAZ1	1SNK900002R0000	50	5.30	
2 End sections 2.0 mm 0.079 in	Dark grey <input type="checkbox"/>	EDK2.5-D	1SNK805913R0000	20	3.88	
3 Jumper bars	Orange <input type="checkbox"/>	2 poles 32 A (IEC)	JB5-2	1SNK905302R0000	50	1.30
		3 poles 32 A (IEC)	JB5-3	1SNK905303R0000	50	2.00
		4 poles 32 A (IEC)	JB5-4	1SNK905304R0000	50	2.70
		5 poles 32 A (IEC)	JB5-5	1SNK905305R0000	50	3.50
		10 poles 32 A (IEC)	JB5-10	1SNK905310R0000	30	7.10
		50 poles 32 A (IEC)	JB5-50	1SNK905350R0000	10	36.00
4 Cross spacing jumpers 3 poles 32 A (IEC)	Orange <input type="checkbox"/>	JB85-3	1SNK900603R0000	10	2.80	
5 Test adapters	Dark grey <input type="checkbox"/>	For test plugs DIA 2 mm 0.079 in	TP2	1SNK900203R0000	20	1.70
		For test plugs DIA 4 mm 0.157 in	TP4	1SNK900205R0000	20	2.40
6 Test connectors	Dark grey <input type="checkbox"/>	5.2 mm 0.205 in spacing	TC5	1SNK900200R0000	10	5.20
		End module, 5.2 mm 0.205 in	TC5-R1	1SNK900201R0000	10	5.20
7 Coding pegs	Dark grey <input type="checkbox"/>	COP-ZD	1SNK900636R0000	10	3.57	
		MC512	1SNK140000R0000	22	9.00	
		MC512PA	1SNK149999R0000	20	10.00	
		MG-CPM 13 41790	1SNB041790R0512	1960	0.236	
8 Terminal block markers	White <input type="checkbox"/>	Blank card				
		Blank marker				
	Grey <input type="checkbox"/>	UMH	1SNK900611R0000	10	0.20	

Complete list of accessories is indicated in the terminal block datasheet including end stops.

Some accessories such as jumper bars may modify the terminal block's ratings: Complete information available in the accessories section of the catalog.

Technical data valid for copper conductors only.

1SNK16402850201

ZDK2.5-D1 PI-Spring pluggable terminal blocks

Double deck feed-through 1 circuit - 5.2 mm 0.205 in spacing

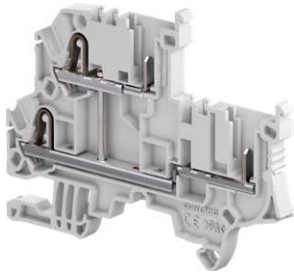

1SNK16425V0014

ZDK2.5-D1

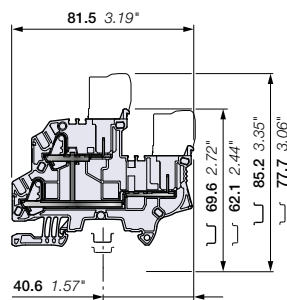

5.2 mm 0.205 in spacing



CDK2.5 CDK2.5-E

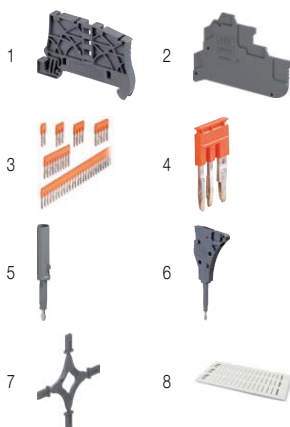

1 2 3 4 5 6 7 8

Description

- Increase your productivity with pluggable terminal blocks: possibility of pre-produced plugs harnesses, time saving plug and play assembly, reduced transportation panels preparation and final installation, easily connect sub-assemblies together,
- Simplify and secure your installation: in site faulty connection errors are eliminated, prior connection testing is eased and reliable, test connectors (TC5) withstanding 10 000 operations are compatible for convenient testing.

Ordering details

Description	Color	Type	Part Number	Pkg qty	Weight (1 pce) g
Feed-through double deck 4 connections	Grey <input type="checkbox"/>	ZDK2.5-D1	1SNK805214R0000	50	12.46

Main technical data

Connecting capacity	IEC	UL - CSA	Rail	TH 35-7.5, TH 35-15
1 conductor per clamp	Rigid: Solid/Stranded	0.2 ... 4 mm ²	26 ... 12 AWG	
	Flexible without ferrule	0.22 ... 2.5 mm ²		11 mm 0.433 in
	Flexible with non insulated ferrule	0.22 ... 2.5 mm ²	26 ... 14 AWG	
	Flexible with insulated ferrule	0.22 ... 2.5 mm ²	26 ... 14 AWG	
2 conductors per clamp	Flexible with twin ferrule	0.22 ... 0.5 mm ²	26 ... 20 AWG	
Rated current / Rated cross section	22 A / 2.5 mm ²	20 A / 12 AWG		
Rated short-time withstand current (1s)	300 A			
Rated voltage	800 V	600 V		
Impulse withstand voltage	8000 V			
Protection	IP20	NEMA 1		

The connecting capacity data for one Rigid: Solid/Stranded, or one Flexible conductor (when applicable) is a mandatory information required by IEC, UL and CSA standards (Copper conductors). All other data are provided as supplementary information only. For more details, please consult our CB, UL or CSA certificates and technical datasheet available on <http://www.TE.com>



Mounting instructions

Wire stripping length	Tool (for flexible conductor without ferrule)	Flat screwdriver
		Ø 3.5 mm Ø 0.138 in

Female plugs

Description	Color	Type	Part Number	Pkg qty	Weight (1 pce) g
Female plugs 1 pole	Grey	<input type="checkbox"/> CDK2.5	1SNK805712R0000	50	2.80
Female plugs without outer nubs - Closed 15 poles max.		<input type="checkbox"/> CDK2.5-E	1SNK805713R0000	50	2.88

Accessories

Description	Color	Type	Part Number	Pkg qty	Weight (1 pce) g	
1 End stops 5.2 mm 0.205 in	Dark grey <input type="checkbox"/>	BAZ1	1SNK900002R0000	50	5.30	
2 End sections 2.0 mm 0.079 in	Dark grey <input type="checkbox"/>	EDK2.5-D	1SNK805913R0000	20	3.88	
3 Jumper bars	Orange <input type="checkbox"/>	2 poles 32 A (IEC)	JB5-2	1SNK905302R0000	50	1.30
		3 poles 32 A (IEC)	JB5-3	1SNK905303R0000	50	2.00
		4 poles 32 A (IEC)	JB5-4	1SNK905304R0000	50	2.70
		5 poles 32 A (IEC)	JB5-5	1SNK905305R0000	50	3.50
		10 poles 32 A (IEC)	JB5-10	1SNK905310R0000	30	7.10
		50 poles 32 A (IEC)	JB5-50	1SNK905350R0000	10	36.00
4 Cross spacing jumpers 3 poles 32 A (IEC)	Orange <input type="checkbox"/>	JB85-3	1SNK900603R0000	10	2.80	
5 Test adapters	Dark grey <input type="checkbox"/>	For test plugs DIA 2 mm 0.079 in	TP2	1SNK900203R0000	20	1.70
		For test plugs DIA 4 mm 0.157 in	TP4	1SNK900205R0000	20	2.40
6 Test connectors	Dark grey <input type="checkbox"/>	5.2 mm 0.205 in spacing	TC5	1SNK900200R0000	10	5.20
		End module, 5.2 mm 0.205 in	TC5-R1	1SNK900201R0000	10	5.20
7 Coding pegs	Dark grey <input type="checkbox"/>	COP-ZD	1SNK900636R0000	10	3.57	
		MC512	1SNK140000R0000	22	9.00	
		MC512PA	1SNK149999R0000	20	10.00	
		MG-CPM 13 41790	1SNB041790R0512	1960	0.236	
8 Terminal block markers	Blank card					
	Blank marker					
	Universal wire markers holder	Grey <input type="checkbox"/>	UMH	1SNK900611R0000	10	0.20

Complete list of accessories is indicated in the terminal block datasheet including end stops. Some accessories such as jumper bars may modify the terminal block's ratings: Complete information available in the accessories section of the catalog.

Technical data valid for copper conductors only.

ZDK2.5-D2-PE PI-Spring pluggable terminal blocks

Double deck feed-through + ground - 5.2 mm 0.205 in spacing

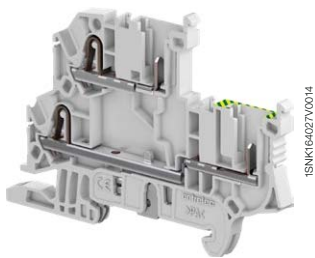

ZDK2.5-D2-PE

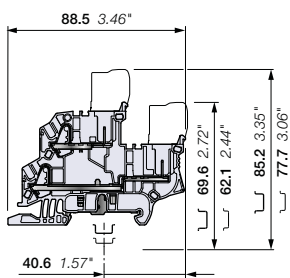

5.2 mm 0.205 in spacing

Available in Q3.2019

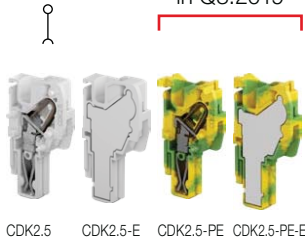

CDK2.5 CDK2.5-E CDK2.5-PE CDK2.5-PE-E

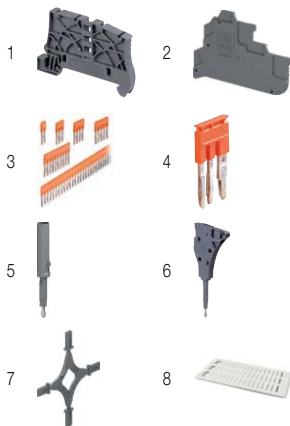

1 2 3 4 5 6 7 8

Description

- Increase your productivity with pluggable terminal blocks: possibility of pre-produced plugs harnesses, time saving plug and play assembly, reduced transportation panels preparation and final installation, easily connect sub-assemblies together,
- Simplify and secure your installation: in site faulty connection errors are eliminated, prior connection testing is eased and reliable, test connectors (TC5) withstanding 10 000 operations are compatible for convenient testing.

Ordering details

Description	Color	Type	Part Number	Pkg qty	Weight (1 pce) g
Feed-through + ground	double deck 4 connections	Grey, Green-yellow	ZDK2.5-D2-PE	1SNK805212R0000	50 16.13

Main technical data

Connecting capacity	IEC	UL - CSA	Mounting instructions		
1 conductor per clamp	Rigid: Solid/Stranded	0.2 ... 4 mm ²	26 ... 12 AWG	Rail	TH 35-7.5, TH 35-15
	Flexible without ferrule	0.22 ... 2.5 mm ²	26 ... 14 AWG	Wire stripping length	11 mm 0.433 in
	Flexible with non insulated ferrule	0.22 ... 2.5 mm ²	26 ... 14 AWG	Tool (for flexible conductor without ferrule)	Flat screwdriver Ø 3.5 mm Ø 0.138 in
	Flexible with insulated ferrule	0.22 ... 2.5 mm ²	26 ... 14 AWG		
2 conductors per clamp	Flexible with twin ferrule	0.22 ... 0.5 mm ²	26 ... 20 AWG		
Rated current / Rated cross section		22 A / 2.5 mm ²	20 A / 12 AWG		
Rated short-time withstand current (1s)		300 A	396 A		
Rated voltage		800 V	600 V		
Impulse withstand voltage		8000 V			
Protection		IP20	NEMA 1		

The connecting capacity data for one Rigid: Solid/Stranded, or one Flexible conductor (when applicable) is a mandatory information required by IEC, UL and CSA standards (Copper conductors). All other data are provided as supplementary information only. For more details, please consult our CB, UL or CSA certificates and technical datasheet available on <http://www.TE.com>

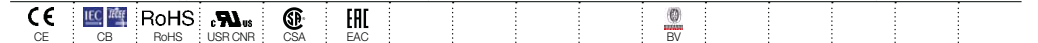

Female plugs

Description	Color	Type	Part Number	Pkg qty	Weight (1 pce) g
Female plugs	1 pole	Grey	CDK2.5	1SNK805712R0000	50 2.80
Female plugs without outer nubs - Closed	1 pole		CDK2.5-E	1SNK805713R0000	50 2.88
Female plugs	1 pole	Green-yellow	CDK2.5-PE	1SNK805750R0000	50 2.80
Female plugs without outer nubs - Closed	1 pole		CDK2.5-PE-E	1SNK805753R0000	50 2.88
15 poles max.					

Accessories

Description	Color	Type	Part Number	Pkg qty	Weight (1 pce) g
1 End stops	5.2 mm 0.205 in	Dark grey	BAZ1	1SNK900002R0000	50 5.30
2 End sections	2.0 mm 0.079 in	Dark grey	EDK2.5-D	1SNK805913R0000	20 3.88
3 Jumper bars	2 poles 32 A (IEC)	Orange	JB5-2	1SNK905302R0000	50 1.30
	3 poles 32 A (IEC)		JB5-3	1SNK905303R0000	50 2.00
	4 poles 32 A (IEC)		JB5-4	1SNK905304R0000	50 2.70
	5 poles 32 A (IEC)		JB5-5	1SNK905305R0000	50 3.50
	10 poles 32 A (IEC)		JB5-10	1SNK905310R0000	30 7.10
4 Cross spacing jumpers	50 poles 32 A (IEC)		JB5-50	1SNK905350R0000	10 36.00
	3 poles 32 A (IEC)	Orange	JB85-3	1SNK900603R0000	10 2.80
5 Test adapters	For test plugs DIA 2 mm 0.079 in	Dark grey	TP2	1SNK900203R0000	20 1.70
	For test plugs DIA 4 mm 0.157 in		TP4	1SNK900205R0000	20 2.40
6 Test connectors	5.2 mm 0.205 in spacing	Dark grey	TC5	1SNK900200R0000	10 5.20
	End module, 5.2 mm 0.205 in		TC5-R1	1SNK900201R0000	10 5.20
7 Coding pegs		Dark grey	COP-ZD	1SNK900636R0000	10 3.57
		White	MC512	1SNK140000R0000	22 9.00
			MC512PA	1SNK149999R0000	20 10.00
			MG-CPM 13 41790	1SNB041790R0512	1960 0.236
8 Terminal block markers	Blank card				
	Blank marker				
	Universal wire markers holder	Grey	UMH	1SNK900611R0000	10 0.20

Complete list of accessories is indicated in the terminal block datasheet including end stops. Some accessories such as jumper bars may modify the terminal block's ratings: Complete information available in the accessories section of the catalog.

Technical data valid for copper conductors only.

1SNK16403050201

ZDK2.5-D1-PE PI-Spring pluggable terminal blocks

Double deck ground - 5.2 mm 0.205 in spacing

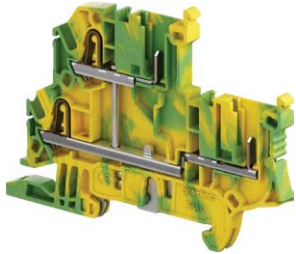

1SNK16402B0004

ZDK2.5-D1-PE

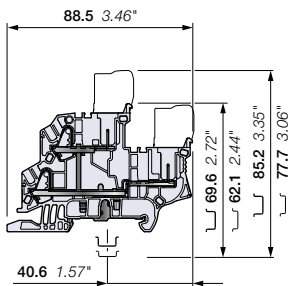

5.2 mm 0.205 in spacing

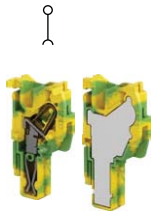

CDK2.5-PE CDK2.5-PE-E

Available in Q3.2019

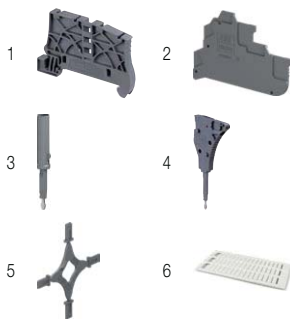

Description

- Increase your productivity with pluggable terminal blocks: possibility of pre-produced plugs harnesses, time saving plug and play assembly, reduced transportation panels preparation and final installation, easily connect sub-assemblies together,
- Simplify and secure your installation: in site faulty connection errors are eliminated, prior connection testing is eased and reliable, test connectors (TC5) withstanding 10 000 operations are compatible for convenient testing.

Ordering details

Description	Color	Type	Part Number	Pkg qty	Weight (1 pce) g
Ground double deck 4 connections	Green-yellow	ZDK2.5-D1-PE	1SNK805250R0000	50	16.80

Main technical data

Connecting capacity	IEC	UL - CSA	Mounting instructions		
1 conductor per clamp	Rigid: Solid/Stranded	0.2 ... 4 mm ²	26 ... 12 AWG	Rail	TH 35-7.5, TH 35-15
	Flexible without ferrule	0.22 ... 2.5 mm ²	26 ... 14 AWG	Wire stripping length	11 mm 0.433 in
	Flexible with non insulated ferrule	0.22 ... 2.5 mm ²	26 ... 14 AWG	Tool (for flexible conductor without ferrule)	Flat screwdriver Ø 3.5 mm Ø 0.138 in
	Flexible with insulated ferrule	0.22 ... 2.5 mm ²	26 ... 14 AWG		
Rated cross section	2.5 mm ²	12 AWG			
Rated short-time withstand current (1s)	300 A	396 A			
Protection	IP20	NEMA 1			

The connecting capacity data for one Rigid: Solid/Stranded, or one Flexible conductor (when applicable) is a mandatory information required by IEC, UL and CSA standards (Copper conductors). All other data are provided as supplementary information only. For more details, please consult our CB, UL or CSA certificates and technical datasheet available on <http://www.TE.com>



Female plugs

Description	Color	Type	Part Number	Pkg qty	Weight (1 pce) g
Female plugs 1 pole	Green-yellow	CDK2.5-PE	1SNK805750R0000	50	2.80
Female plugs without outer nubs - Closed 15 poles max.		CDK2.5-PE-E	1SNK805753R0000	50	2.88

Accessories

Description	Color	Type	Part Number	Pkg qty	Weight (1 pce) g
1 End stops 5.2 mm 0.205 in	Dark grey	BAZ1	1SNK900002R0000	50	5.30
2 End sections 2.0 mm 0.079 in	Dark grey	EDK2.5-D	1SNK805913R0000	20	3.88
3 Test adapters	Dark grey	TP2	1SNK900203R0000	20	1.70
	Dark grey	TP4	1SNK900205R0000	20	2.40
4 Test connectors 5.2 mm 0.205 in spacing	Dark grey	TC5	1SNK900200R0000	10	5.20
	Dark grey	TC5-R1	1SNK900201R0000	10	5.20
5 Coding pegs	Dark grey	COP-ZD	1SNK900636R0000	10	3.57
6 Terminal block markers	White	MC512	1SNK140000R0000	22	9.00
	Grey	UMH	1SNK149999R0000	20	10.00
Universal wire markers holder	Grey	UMH	1SNK900611R0000	10	0.20

Complete list of accessories is indicated in the terminal block datasheet including end stops. Some accessories such as jumper bars may modify the terminal block's ratings: Complete information available in the accessories section of the catalog.

Technical data valid for copper conductors only.

CDK2.5 PI-Spring female plugs

Female plug - 5.2 mm 0.205 in spacing

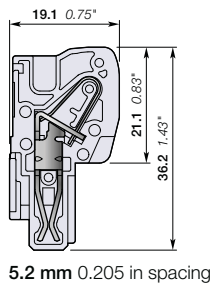
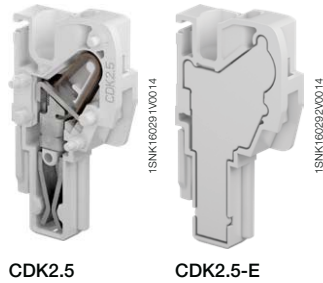

Description

- Create your own female plug assemblies without any special tools, easily snap together multiple plugs for optimal ergonomics and quick assembly,
- Increase your flexibility: eliminate stock of pre-configured female plugs, easily add an extra plug in case of needed modification,
- Reduce your stock of unitary plugs up to 30%: only two plug variants are required to compose your own subsets of plugs from 2 to 15 poles.

Ordering details

Description	Color	Type	Part number	Pkg qty	Weight (1 pce) g
Female plugs	Grey	CDK2.5	1SNK805712R0000	50	2.80
	Blue	CDK2.5-BL	1SNK805742R0000	50	2.80
	Green-Yellow	CDK2.5-PE	1SNK805750R0000	50	2.80
Female plugs without outer nubs - Closed	Grey	CDK2.5-E	1SNK805713R0000	50	2.80
	Blue	CDK2.5-BL-E	1SNK805743R0000	50	2.80
	Green-Yellow	CDK2.5-PE-E	1SNK805753R0000	50	2.80

Main technical data

Connecting capacity	IEC	UL - CSA	Mounting instructions
1 conductor per clamp	Rigid: Solid/Stranded	26 ... 12 AWG	Rail
	Flexible without ferrule	0.22 ... 2.5 mm²	Wire stripping length
	Flexible with non insulated ferrule	0.22 ... 2.5 mm²	11 mm 0.433 in
	Flexible with insulated ferrule	0.22 ... 2.5 mm²	
2 conductors per clamp	Flexible with twin ferrule	26 ... 20 AWG	Tool (for flexible conductor without ferrule)
Rated current / Rated cross section		24 A / 2.5 mm²	22 A / 12 AWG
Rated short-time withstand current (1s)		300 A	
Rated voltage		1000 V	600 V
Impulse withstand voltage		8000 V	
Protection		IP20	NEMA 1

The connecting capacity data for one Rigid: Solid/Stranded, or one Flexible conductor (when applicable) is a mandatory information required by IEC, UL and CSA standards (Copper conductors). All other data are provided as supplementary information only. For more details, please consult our CB, UL or CSA certificates and technical datasheet available on <http://www.TE.com>

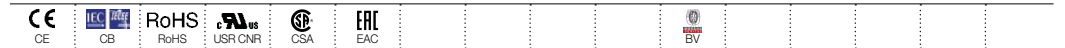

Mounting instructions

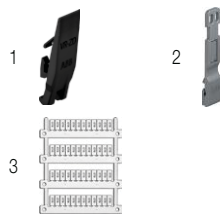

Accessories

Description	Color	Type	Part number	Pkg qty	Weight (1 pce) g
1 Locking devices	Black	VR-ZD	1SNK900637R0000	50	0.7
2 Cable clamp	Dark grey	PT-ZD	1SNK900660R0000	50	1.04
3 Terminal block markers	White	MG-CPM 13 41790	1SNB041790R0512	1960	0.23
		MG-CPMFA 43196	1SNB043196R0012	350	2.56
		MC512	1SNK140000R0000	22	9.00
	MC512PA	1SNK149999R0000	20	10.00	
	Universal wire markers holder	Grey	UMH	1SNK900611R0000	10

Complete list of accessories is indicated in the terminal block datasheet including end stops. Some accessories such as jumper bars may modify the terminal block's ratings: Complete information available in the accessories section of the catalog.

Technical data valid for copper conductors only.

CDK2.5-J PI-Spring female plugs

Female plug - 5.2 mm 0.205 in spacing

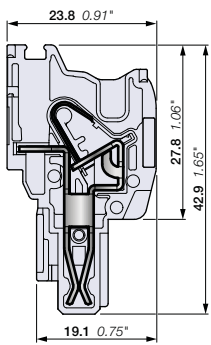
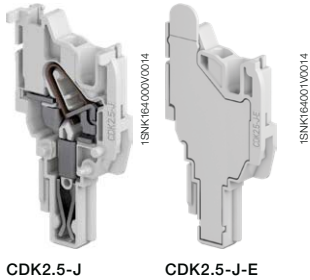

5.2 mm 0.205 in spacing

Description

- Create your own female plug assemblies without any special tools, easily snap together multiple plugs for optimal ergonomics and quick assembly,
- Increase your flexibility: eliminate stock of pre-configured female plugs, easily add an extra plug in case of needed modification,
- Reduce your stock of unitary plugs up to 30%: only two plug variants are required to compose your own subsets of plugs from 2 to 15 poles.

Description	Color	Type	Part Number	Pkg qty	Weight (1 pce) g
Female plugs	Grey	CDK2.5-J	1SNK805738R0000	50	4.08
	Blue	CDK2.5-J-BL	1SNK805744R0000	50	4.08
	Green-yellow	CDK2.5-J-PE	1SNK805748R0000	50	4.08
Female plugs without outer nubs - Closed	Grey	CDK2.5-J-E	1SNK805739R0000	50	4.34
	Blue	CDK2.5-J-BL-E	1SNK805745R0000	50	4.34
	Green-yellow	CDK2.5-J-PE-E	1SNK805749R0000	50	4.34

Main technical data

Connecting capacity	IEC	UL - CSA	Mounting instructions
1 conductor per clamp	Rigid: Solid/Stranded	0.2 ... 4 mm ²	Rail Wire stripping length 11 mm / 0.433 in
	Flexible without ferrule	0.22 ... 2.5 mm ²	
	Flexible with non insulated ferrule	0.22 ... 2.5 mm ²	
	Flexible with insulated ferrule	0.22 ... 2.5 mm ²	
2 conductors per clamp	Flexible with twin ferrule	0.22 ... 0.5 mm ²	Tool (for flexible conductor without ferrule) Flat screwdriver Ø 3.5 mm / Ø 0.138 in
Rated current / Rated cross section	24 A / 2.5 mm ²	20 A / 12 AWG	
Rated short-time withstand current (1s)	300 A		
Rated voltage	800 V	600 V	
Impulse withstand voltage	8000 V		
Protection	IP20	NEMA 1	

The connecting capacity data for one Rigid: Solid/Stranded, or one Flexible conductor (when applicable) is a mandatory information required by IEC, UL and CSA standards (Copper conductors). All other data are provided as supplementary information only. For more details, please consult our CB, UL or CSA certificates and technical datasheet available on <http://www.TE.com>



Mounting instructions

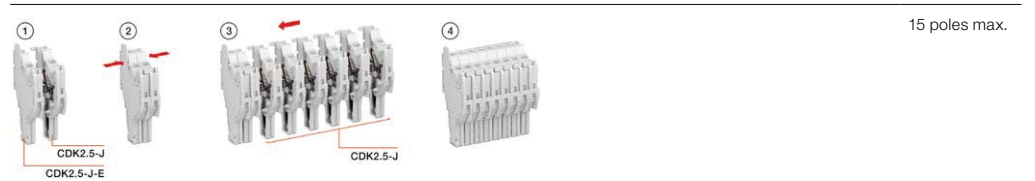

Accessories



Description	Color	Type	Part Number	Pkg qty	Weight (1 pce) g	
1 Jumper bars	Orange	2 poles 32 A (IEC)	JB5-2	1SNK905302R0000	50	1.30
		3 poles 32 A (IEC)	JB5-3	1SNK905303R0000	50	2.00
		4 poles 32 A (IEC)	JB5-4	1SNK905304R0000	50	2.70
		5 poles 32 A (IEC)	JB5-5	1SNK905305R0000	50	3.50
		10 poles 32 A (IEC)	JB5-10	1SNK905310R0000	30	7.10
		50 poles 32 A (IEC)	JB5-50	1SNK905350R0000	10	36.00
2 Test adapters	Dark grey	For test plugs DIA 2 mm 0.079 in	TP2	1SNK900203R0000	20	1.70
		For test plugs DIA 4 mm 0.157 in	TP4	1SNK900205R0000	20	2.40
3 Test connectors	Dark grey	5.2 mm 0.205 in spacing	TC5	1SNK900200R0000	10	5.20
		End module, 5.2 mm 0.205 in	TC5-R1	1SNK900201R0000	10	5.20
4 Locking devices	Black	VR-ZD	1SNK900637R0000	50	0.7	
5 Strain Relief	Dark grey	PT-ZD	1SNK900660R0000	50	1.04	
6 Terminal block markers	White	Blank card	MC512	1SNK140000R0000	22	9.00
			MC512PA	1SNK149999R0000	20	10.00
	Blank strip label	MG-CPMFA 43196	1SNB043196R0012	400	2.562	
	Blank marker	MG-CPM 13 41790	1SNB041790R0512	1960	0.236	
	Grey	UMH	1SNK900611R0000	10	0.20	

Complete list of accessories is indicated in the terminal block datasheet including end stops.

Some accessories such as jumper bars may modify the terminal block's ratings: Complete information available in the accessories section of the catalog.

Technical data valid for copper conductors only.

CDK2.5-2P-J PI-Spring female plugs

Female plug - 5.2 mm 0.205 in spacing

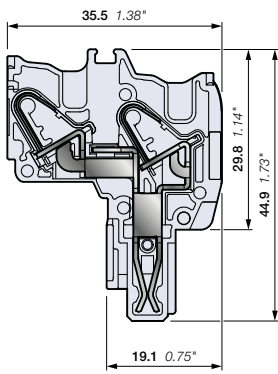
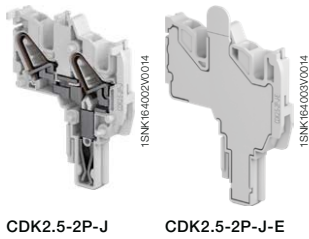

5.2 mm 0.205 in spacing

Description

- Create your own female plug assemblies without any special tools, easily snap together multiple plugs for optimal ergonomics and quick assembly,
- Increase your flexibility: eliminate stock of pre-configured female plugs, easily add an extra plug in case of needed modification,
- Reduce your stock of unitary plugs up to 30%: only two plug variants are required to compose your own subsets of plugs from 2 to 15 poles.

Description	Color	Type	Part Number	Pkg qty	Weight (1 pce)
Female plugs	Grey	<input type="checkbox"/> CDK2.5-2P-J	1SNK805740R0000	50	5.37
	Blue	<input type="checkbox"/> CDK2.5-2P-J-BL	1SNK805746R0000	50	5.37
	Green-yellow	<input type="checkbox"/> CDK2.5-2P-J-PE	1SNK805751R0000	50	5.37
Female plugs without outer nubs - Closed	Grey	<input type="checkbox"/> CDK2.5-2P-J-E	1SNK805741R0000	50	5.74
	Blue	<input type="checkbox"/> CDK2.5-2P-J-BL-E	1SNK805747R0000	50	5.74
	Green-yellow	<input type="checkbox"/> CDK2.5-2P-J-PE-E	1SNK805752R0000	50	5.74

Main technical data

Connecting capacity	IEC	UL - CSA	Rail
1 conductor per clamp	Rigid: Solid/Stranded	0.2 ... 4 mm²	26 ... 12 AWG
	Flexible without ferrule	0.22 ... 2.5 mm²	
	Flexible with non insulated ferrule	0.22 ... 2.5 mm²	26 ... 14 AWG
	Flexible with insulated ferrule	0.22 ... 2.5 mm²	26 ... 14 AWG
2 conductors per clamp	Flexible with twin ferrule	0.22 ... 0.5 mm²	26 ... 20 AWG
Rated current / Rated cross section	24 A / 2.5 mm²	20 A / 12 AWG	
Rated short-time withstand current (1s)	300 A		
Rated voltage	500 V	600 V	
Impulse withstand voltage	6000 V		
Protection	IP20	NEMA 1	

Mounting instructions

Wire stripping length	Tool (for flexible conductor without ferrule)	Flat screwdriver
11 mm 0.433 in		Ø 3.5 mm Ø 0.138 in

The connecting capacity data for one Rigid: Solid/Stranded, or one Flexible conductor (when applicable) is a mandatory information required by IEC, UL and CSA standards (Copper conductors). All other data are provided as supplementary information only. For more details, please consult our CB, UL or CSA certificates and technical datasheet available on <http://www.TE.com>



Mounting instructions

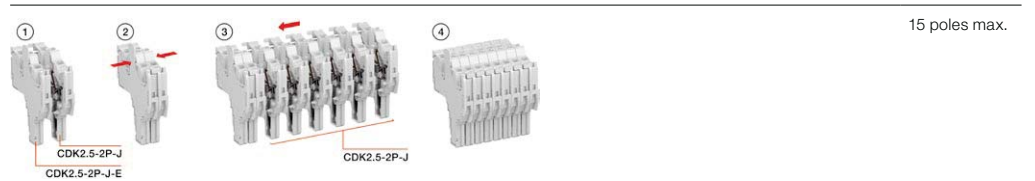

15 poles max.



Accessories

Description	Color	Type	Part Number	Pkg qty	Weight (1 pce)	
1 Jumper bars	Orange	2 poles	JB5-2	1SNK905302R0000	50	1.30
		3 poles	JB5-3	1SNK905303R0000	50	2.00
		4 poles	JB5-4	1SNK905304R0000	50	2.70
		5 poles	JB5-5	1SNK905305R0000	50	3.50
		10 poles	JB5-10	1SNK905310R0000	30	7.10
		50 poles	JB5-50	1SNK905350R0000	10	36.00
2 Test adapters	Dark grey	For test plugs DIA 2 mm 0.079 in	TP2	1SNK900203R0000	20	1.70
		For test plugs DIA 4 mm 0.157 in	TP4	1SNK900205R0000	20	2.40
3 Test connectors	Dark grey	5.2 mm 0.205 in spacing	TC5	1SNK900200R0000	10	5.20
		End module, 5.2 mm 0.205 in	TC5-R1	1SNK900201R0000	10	5.20
4 Locking devices	Black	VR-ZD	1SNK900637R0000	50	0.7	
5 Strain Relief	Dark grey	PT-ZD	1SNK900660R0000	50	1.04	
6 Terminal block markers	White	MC512	1SNK140000R0000	22	9.00	
		MC512PA	1SNK149999R0000	20	10.00	
	Grey	MG-CPMFA 43196	1SNB043196R0012	400	2.562	
		MG-CPM 13 41790	1SNB041790R0512	1960	0.236	
Universal wire markers holder	UMH	1SNK900611R0000	10	0.20		

Complete list of accessories is indicated in the terminal block datasheet including end stops.

Some accessories such as jumper bars may modify the terminal block's ratings: Complete information available in the accessories section of the catalog.

Technical data valid for copper conductors only.

1SNK1640350201

CDK4 PI-Spring female plugs

Female plug - 6 mm 0.236 in spacing

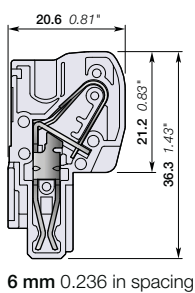
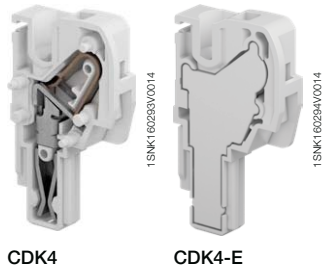
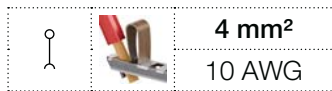

Description

- Create your own female plug assemblies without any special tools, easily snap together multiple plugs for optimal ergonomics and quick assembly,
- Increase your flexibility: eliminate stock of pre-configured female plugs, easily add an extra plug in case of needed modification,
- Reduce your stock of unitary plugs up to 30%: only two plug variants are required to compose your own subsets of plugs from 2 to 15 poles.

Ordering details

Description	Color	Type	Part Number	Pkg qty	Weight (1 pce) g
Female plugs	Grey <input type="checkbox"/>	CDK4	1SNK806712R0000	50	3.80
Female plugs without outer nubs - Closed		CDK4-E	1SNK806713R0000	50	4.50

Main technical data

Connecting capacity		IEC	UL - CSA	Mounting instructions	
1 conductor per clamp	Rigid: Solid/Stranded	0.5 ... 6 mm ²	26 ... 10 AWG	Rail	
	Flexible without ferrule	0.5 ... 4 mm ²			
	Flexible with non insulated ferrule	0.5 ... 4 mm ²	26 ... 12 AWG	Wire stripping length	12.5 mm 0.492 in
	Flexible with insulated ferrule	0.5 ... 4 mm ²	26 ... 12 AWG		
2 conductors per clamp	Flexible with twin ferrule	0.5 ... 1 mm ²	26 ... 18 AWG	Tool (for flexible conductor without ferrule)	Flat screwdriver Ø 3.5 mm Ø 0.138 in
Rated current / Rated cross section		30 A / 4 mm ²	30 A / 10 AWG		
Rated short-time withstand current (1s)		480 A			
Rated voltage		1000 V	600 V		
Impulse withstand voltage		8000 V			
Protection		IP20	NEMA 1		

The connecting capacity data for one Rigid: Solid/Stranded, or one Flexible conductor (when applicable) is a mandatory information required by IEC, UL and CSA standards (Copper conductors). All other data are provided as supplementary information only. For more details, please consult our CB, UL or CSA certificates and technical datasheet available on <http://www.TE.com>

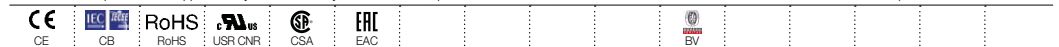

Mounting instructions



Accessories

Description	Color	Type	Part Number	Pkg qty	Weight (1 pce) g
1 Locking devices 9.4 mm 0.370 in spacing	Black <input checked="" type="checkbox"/>	VR-ZD	1SNK900637R0000	50	0.7
2 Cable Clamp 9.4 mm 0.370 in spacing	Dark grey <input checked="" type="checkbox"/>	PT-ZD	1SNK900660R0000	50	1.04
3 Terminal block markers	White <input type="checkbox"/>	MG-CPM 13 41791	1SNB041791R0612	1680	0.27
		MG-CPMFA 43196	1SNB043196R0012	350	2.56
		MC612	1SNK150000R0000	22	10.00
		MC612PA	1SNK159999R0000	20	11.00
	Universal wire markers holder	Grey <input type="checkbox"/>	UMH	1SNK900611R0000	10

Complete list of accessories is indicated in the terminal block datasheet including end stops. Some accessories such as jumper bars may modify the terminal block's ratings: Complete information available in the accessories section of the catalog.

Technical data valid for copper conductors only.

Screw clamp Pluggable

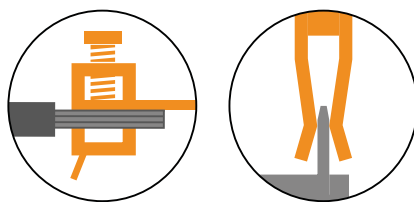

ZDS4-22 Screw clamp pluggable terminal blocks

Feed-through - 5.2 mm 0.205 in spacing

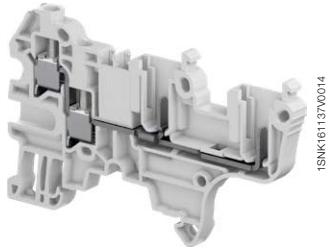

ZDS4-22

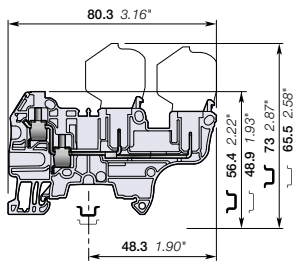

5.2 mm 0.205 in spacing

Description

- Increase your productivity with pluggable terminal blocks: possibility of pre-produced plugs harnesses, time saving plug and play assembly, reduced transportation panels preparation and final installation, easily connect sub-assemblies together,
- Simplify and secure your installation: in site faulty connection errors are eliminated, prior connection testing is eased and reliable, test connectors (TC5) withstanding 10 000 operations are compatible for convenient testing.

Ordering details

Description	Color	Type	Part Number	Pkg qty	Weight (1 pce) g
Feed-through 4 connections	Grey <input type="checkbox"/>	ZDS4-22	1SNK805013R0000	50	10.80

Main technical data

Connecting capacity		IEC	UL - CSA
1 conductor per clamp	Rigid: Solid/Stranded	0.2 ... 4 mm²	24 ... 10 AWG
	Flexible without ferrule	0.22 ... 4 mm²	24 ... 10 AWG
	Flexible with non insulated ferrule	0.22 ... 4 mm²	24 ... 10 AWG
	Flexible with insulated ferrule	0.22 ... 2.5 mm²	24 ... 12 AWG
	Gauge	A3-B3	
2 conductors per clamp	Rigid: Solid/Stranded	0.2 ... 1.5 mm²	24 ... 16 AWG
	Flexible without ferrule	0.22 ... 1.5 mm²	24 ... 16 AWG
	Flexible with twin ferrule	0.22 ... 1.5 mm²	24 ... 16 AWG
Rated current / Rated cross section		29 A / 4 mm²	28 A / 10 AWG
Rated short-time withstand current (1s)		480 A	
Rated voltage		800 V	300 V
Impulse withstand voltage		8000 V	
Protection		IP20	NEMA 1

Mounting instructions

Rail		TH 35-7.5, TH 35-15
Wire stripping length		10.5 mm 0.413 in
Tool		Flat screwdriver Ø 3.5 mm Ø 0.138 in
Torque		0.6 Nm ± 0.1 5.31 lb.in ± 0.885

The connecting capacity data for one Rigid: Solid/Stranded, or one Flexible conductor (when applicable) is a mandatory information required by IEC, UL and CSA standards (Copper conductors). All other data are provided as supplementary information only. For more details, please consult our CB, UL or CSA certificates and technical datasheet available on <http://www.TE.com>

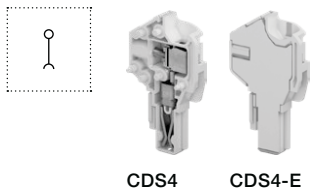
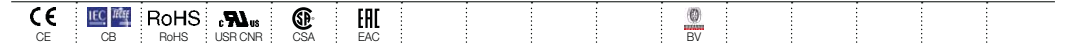

CDS4

CDS4-E

Female plugs

Description	Color	Type	Part Number	Pkg qty	Weight (1 pce) g
Female plugs 1 pole	Grey <input type="checkbox"/>	CDS4	1SNK805714R0000	50	3.90
Female plugs without outer nubs - Closed		CDS4-E	1SNK805715R0000	50	4.10

15 poles max.

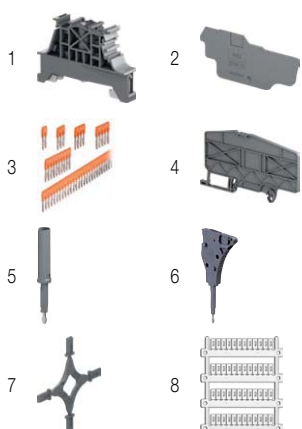

Accessories

Description	Color	Type	Part Number	Pkg qty	Weight (1 pce) g	
1 End stops 10 mm 0.394 in	Dark grey <input type="checkbox"/>	BAM4	1SNK900001R0000	50	14.00	
2 End sections 0.8 mm 0.031 in	Dark grey <input type="checkbox"/>	EDS4-22	1SNK805911R0000	20	1.85	
3 Jumper bars	Orange <input type="checkbox"/>	2 poles 32 A (IEC)	JB5-2	1SNK905302R0000	50	1.30
		3 poles 32 A (IEC)	JB5-3	1SNK905303R0000	50	2.00
		4 poles 32 A (IEC)	JB5-4	1SNK905304R0000	50	2.70
		5 poles 32 A (IEC)	JB5-5	1SNK905305R0000	50	3.50
		10 poles 32 A (IEC)	JB5-10	1SNK905310R0000	30	7.10
50 poles 32 A (IEC)		JB5-50	1SNK905350R0000	10	36.00	
4 Circuit separators 3 mm 0.118 in	Dark grey <input type="checkbox"/>	CS-R3	1SNK900107R0000	20	6.40	
5 Test adapters	Dark grey <input type="checkbox"/>	For test plugs DIA 2 mm 0.079 in	TP2	1SNK900203R0000	20	1.70
		For test plugs DIA 4 mm 0.157 in	TP4	1SNK900205R0000	20	2.40
6 Test connectors	Dark grey <input type="checkbox"/>	5.2 mm 0.205 in spacing	TC5	1SNK900200R0000	10	5.20
		End module, 5.2 mm 0.205 in	TC5-R1	1SNK900201R0000	10	5.20
7 Coding pegs	Dark grey <input type="checkbox"/>	COP-ZD	1SNK900636R0000	10	3.57	
8 Terminal block markers	White <input type="checkbox"/>	Blank marker	MG-CPM 13 41790	1SNB041790R0512	1960	0.23
		Blank card	MC512	1SNK140000R0000	22	9.00
			MC512PA	1SNK149999R0000	20	10.00
		Universal wire markers holder	Grey <input type="checkbox"/>	UMH	1SNK900611R0000	10

Complete list of accessories is indicated in the terminal block datasheet including end stops. Some accessories such as jumper bars may modify the terminal block's ratings: Complete information available in the accessories section of the catalog.

Technical data valid for copper conductors only.

CDS4 Screw clamp female plugs

Female plug - 5.2 mm 0.205 in spacing



4 mm²
10 AWG

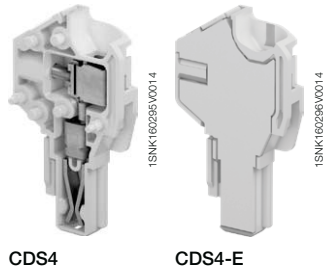

CDS4 CDS4-E

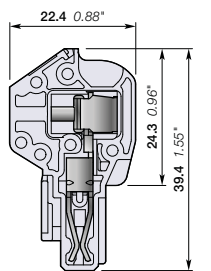

5.2 mm 0.205 in spacing

Description

- Create your own female plug assemblies without any special tools, easily snap together multiple plugs for optimal ergonomics and quick assembly,
- Increase your flexibility: eliminate stock of pre-configured female plugs, easily add an extra plug in case of needed modification,
- Reduce your stock of unitary plugs up to 30%: only two plug variants are required to compose your own subsets of plugs from 2 to 15 poles.

Ordering details

Description	Color	Type	Part Number	Pkg qty	Weight (1 pce) g
Female plugs	Grey <input type="checkbox"/>	CDS4	1SNK805714R0000	50	3.90
Female plugs without outer nubs - Closed		CDS4-E	1SNK805715R0000	50	4.10

Main technical data

Connecting capacity		IEC	UL - CSA	Mounting instructions	
1 conductor per clamp	Rigid: Solid/Stranded	0.2 ... 4 mm ²	24 ... 10 AWG	Rail	
	Flexible without ferrule	0.22 ... 4 mm ²		Wire stripping length	10.5 mm 0.413 in
	Flexible with non insulated ferrule	0.22 ... 4 mm ²	24 ... 10 AWG		
	Flexible with insulated ferrule	0.22 ... 2.5 mm ²	24 ... 12 AWG		
	Gauge	A3-B3			
2 conductors per clamp	Rigid: Solid/Stranded	0.2 ... 1.5 mm ²	24 ... 16 AWG	Tool	Flat screwdriver Ø 3.5 mm Ø 0.138 in
	Flexible without ferrule	0.22 ... 1.5 mm ²			
	Flexible with twin ferrule	0.22 ... 1.5 mm ²	24 ... 16 AWG		
Rated current / Rated cross section		29 A / 4 mm ²	28 A / 10 AWG	Torque	0.6 Nm ± 0.1 5.31 lb.in ± 0.885
Rated short-time withstand current (1s)		480 A			
Rated voltage		800 V	300 V		
Impulse withstand voltage		8000 V			
Protection		IP20	NEMA 1		

The connecting capacity data for one Rigid: Solid/Stranded, or one Flexible conductor (when applicable) is a mandatory information required by IEC, UL and CSA standards (Copper conductors). All other data are provided as supplementary information only. For more details, please consult our CB, UL or CSA certificates and technical datasheet available on <http://www.TE.com>



Mounting instructions

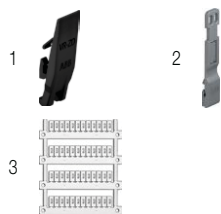
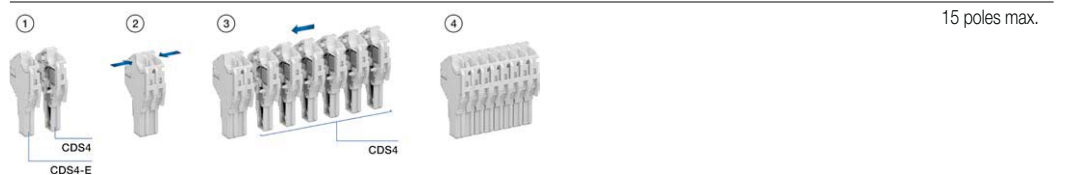

Accessories

Description	Color	Type	Part Number	Pkg qty	Weight (1 pce) g
1 Locking devices	Black <input checked="" type="checkbox"/>	VR-ZD	1SNK900637R0000	50	0.7
2 Cable Clamp	Dark grey <input checked="" type="checkbox"/>	PT-ZD	1SNK900660R0000	50	1.04
3 Terminal block markers	White <input type="checkbox"/>	MG-CPM 13 41790	1SNB041790R0512	1960	0.23
		MG-CPMFA 43196	1SNB043196R0012	350	2.56
		MC512	1SNK140000R0000	22	9.00
		MC512PA	1SNK149999R0000	20	10.00
	Universal wire markers holder	Grey <input type="checkbox"/>	UMH	1SNK900611R0000	10

Complete list of accessories is indicated in the terminal block datasheet including end stops. Some accessories such as jumper bars may modify the terminal block's ratings: Complete information available in the accessories section of the catalog.

Technical data valid for copper conductors only.

ZDS4-22-R1 Screw clamp pluggable terminal blocks

Feed-through - 6 mm 0.236 in spacing

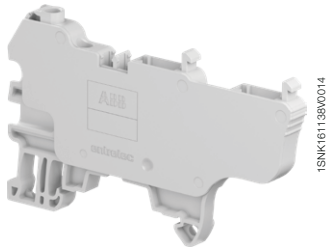

ZDS4-22-R1

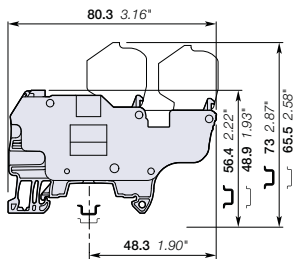

6 mm 0.236 in spacing

Description

- Increase your productivity with pluggable terminal blocks: possibility of pre-produced plugs harnesses, time saving plug and play assembly, reduced transportation panels preparation and final installation, easily connect sub-assemblies together,
- Simplify and secure your installation: in site faulty connection errors are eliminated, prior connection testing is eased and reliable, test connectors (TC5-R1 + ES-TC6) withstanding 10 000 operations are compatible for convenient testing.

Ordering details

Description	Color	Type	Part Number	Pkg qty	Weight (1 pce) g
Feed-through 4 connections	Grey <input type="checkbox"/>	ZDS4-22-R1	1SNK806013R0000	40	12.60

Main technical data

Connecting capacity		IEC	UL - CSA
1 conductor per clamp	Rigid: Solid/Stranded	0.2 ... 4 mm²	24 ... 10 AWG
	Flexible without ferrule	0.22 ... 4 mm²	24 ... 10 AWG
	Flexible with non insulated ferrule	0.22 ... 4 mm²	24 ... 10 AWG
	Flexible with insulated ferrule	0.22 ... 4 mm²	24 ... 10 AWG
	Gauge	A3-B3	
2 conductors per clamp	Rigid: Solid/Stranded	0.2 ... 1.5 mm²	24 ... 16 AWG
	Flexible without ferrule	0.22 ... 1.5 mm²	24 ... 16 AWG
	Flexible with twin ferrule	0.22 ... 1.5 mm²	24 ... 16 AWG
Rated current / Rated cross section		29 A / 4 mm²	28 A / 10 AWG
Rated short-time withstand current (1s)		480 A	
Rated voltage		800 V	300 V
Impulse withstand voltage		8000 V	
Protection		IP20	NEMA 1

Mounting instructions

Rail		TH 35-7.5, TH 35-15
Wire stripping length		10.5 mm 0.413 in
Tool		Flat screwdriver Ø 3.5 mm Ø 0.138 in
Torque		0.6 Nm ± 0.1 5.31 lb.in ± 0.885

The connecting capacity data for one Rigid: Solid/Stranded, or one Flexible conductor (when applicable) is a mandatory information required by IEC, UL and CSA standards (Copper conductors). All other data are provided as supplementary information only. For more details, please consult our CB, UL or CSA certificates and technical datasheet available on <http://www.TE.com>

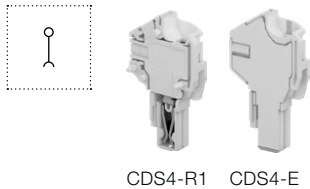
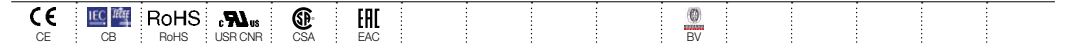

CDS4-R1 CDS4-E

Female plugs

Description	Color	Type	Part Number	Pkg qty	Weight (1 pce) g
Female plugs 1 pole	Grey <input type="checkbox"/>	CDS4-R1	1SNK806714R0000	50	4.10
Female plugs without outer nubs - Closed		CDS4-E	1SNK805715R0000	50	4.10

15 poles max.

Accessories

Description	Color	Type	Part Number	Pkg qty	Weight (1 pce) g	
1 End stops 10 mm 0.394 in	Dark grey <input type="checkbox"/>	BAM4	1SNK900001R0000	50	14.00	
2 Jumper bars	Orange <input type="checkbox"/>	2 poles 41 A (IEC)	JB6-2	1SNK906302R0000	50	1.30
		3 poles 41 A (IEC)	JB6-3	1SNK906303R0000	50	2.10
		4 poles 41 A (IEC)	JB6-4	1SNK906304R0000	50	2.90
		5 poles 41 A (IEC)	JB6-5	1SNK906305R0000	50	3.60
		10 poles 41 A (IEC)	JB6-10	1SNK906310R0000	20	7.40
50 poles 41 A (IEC)	JB6-50	1SNK906350R0000	10	38.10		
3 Circuit separators 3 mm 0.118 in	Dark grey <input type="checkbox"/>	CS-R3	1SNK900107R0000	20	6.40	
4 Test adapters	Dark grey <input type="checkbox"/>	For test plugs DIA 2 mm 0.079 in	TP2	1SNK900203R0000	20	1.70
	Dark grey <input type="checkbox"/>	For test plugs DIA 4 mm 0.157 in	TP4	1SNK900205R0000	20	2.40
5 Test connectors End module, 5.2 mm 0.205 in	Dark grey <input type="checkbox"/>	TC5-R1	1SNK900201R0000	10	5.20	
6 Spacers 0.8 mm 0.031 in	Dark grey <input type="checkbox"/>	ES-TC6	1SNK900105R0000	10	0.80	
7 Coding pegs	Dark grey <input type="checkbox"/>	COP-ZD	1SNK900636R0000	10	3.57	
8 Terminal block markers	White <input type="checkbox"/>	Blank marker	MG-CPM 13 41791	1SNB041791R0612	1680	0.27
		Blank card	MC612	1SNK150000R0000	22	10.00
			MC612PA	1SNK159999R0000	20	11.00
	Universal wire markers holder	Grey <input type="checkbox"/>	UMH	1SNK900611R0000	10	0.20

Complete list of accessories is indicated in the terminal block datasheet including end stops.

Some accessories such as jumper bars may modify the terminal block's ratings: Complete information available in the accessories section of the catalog.

Technical data valid for copper conductors only.

CDS4-R1 Screw clamp female plugs

Female plug - 6 mm 0.236 in spacing

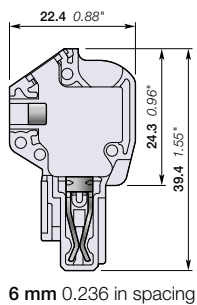
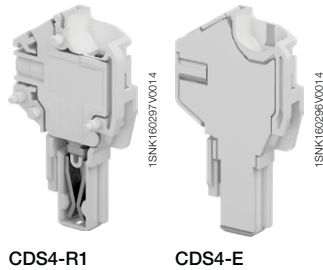

Description

- Create your own female plug assemblies without any special tools, easily snap together multiple plugs for optimal ergonomics and quick assembly,
- Increase your flexibility: eliminate stock of pre-configured female plugs, easily add an extra plug in case of needed modification,
- Reduce your stock of unitary plugs up to 30%: only two plug variants are required to compose your own subsets of plugs from 2 to 15 poles.

Ordering details

Description	Color	Type	Part Number	Pkg qty	Weight (1 pce) g
Female plugs	Grey <input type="checkbox"/>	CDS4-R1	1SNK806714R0000	50	4.10
Female plugs without outer nubs - Closed		CDS4-E	1SNK805715R0000	50	4.10

Main technical data

Connecting capacity		IEC	UL - CSA	Mounting instructions	
1 conductor per clamp	Rigid: Solid/Stranded	0.2 ... 4 mm²	24 ... 10 AWG	Rail	
	Flexible without ferrule	0.22 ... 4 mm²		Wire stripping length	10.5 mm 0.413 in
	Flexible with non insulated ferrule	0.22 ... 4 mm²	24 ... 10 AWG		
	Flexible with insulated ferrule	0.22 ... 4 mm²	24 ... 10 AWG		
	Gauge	A3-B3			
2 conductors per clamp	Rigid: Solid/Stranded	0.2 ... 1.5 mm²	24 ... 16 AWG	Tool	Flat screwdriver Ø 3.5 mm Ø 0.138 in
	Flexible without ferrule	0.22 ... 1.5 mm²			
	Flexible with twin ferrule	0.22 ... 1.5 mm²	24 ... 16 AWG		
Rated current / Rated cross section		29 A / 4 mm²	28 A / 10 AWG	Torque	0.6 Nm ± 0.1 5.31 lb.in ± 0.885
Rated short-time withstand current (1s)		480 A			
Rated voltage		800 V	300 V		
Impulse withstand voltage		8000 V			
Protection		IP20	NEMA 1		

The connecting capacity data for one Rigid: Solid/Stranded, or one Flexible conductor (when applicable) is a mandatory information required by IEC, UL and CSA standards (Copper conductors). All other data are provided as supplementary information only. For more details, please consult our CB, UL or CSA certificates and technical datasheet available on <http://www.TE.com>

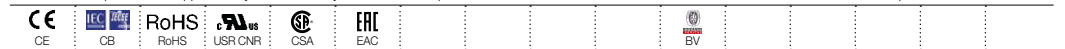

Mounting instructions



15 poles max.

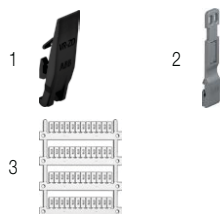

Accessories

Description	Color	Type	Part Number	Pkg qty	Weight (1 pce) g
1 Locking devices	Black <input checked="" type="checkbox"/>	VR-ZD	1SNK900637R0000	50	0.7
2 Cable Clamp	Dark grey <input checked="" type="checkbox"/>	PT-ZD	1SNK900660R0000	50	1.04
3 Terminal block markers	White <input type="checkbox"/>	MG-CPM 13 41791	1SNB041791R0612	1680	0.27
		MG-CPMFA 43196	1SNB043196R0012	350	2.56
		MC612	1SNK150000R0000	22	10.00
		MC612PA	1SNK159999R0000	20	11.00
	Universal wire markers holder	Grey <input type="checkbox"/>	UMH	1SNK900611R0000	10

Complete list of accessories is indicated in the terminal block datasheet including end stops. Some accessories such as jumper bars may modify the terminal block's ratings: Complete information available in the accessories section of the catalog.

Technical data valid for copper conductors only.

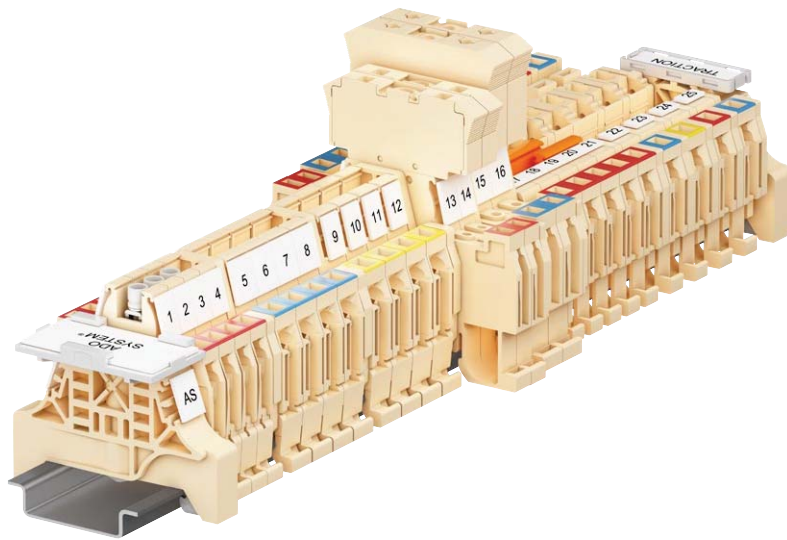

Railway applications, terminal blocks

ADO System® IDC and pluggable technologies

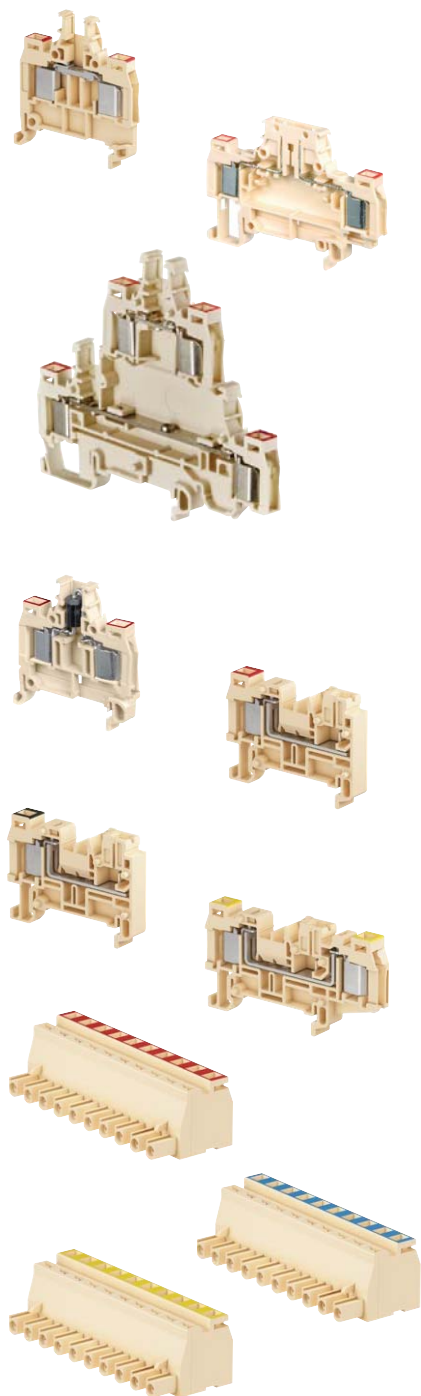

Technologies presentation		104	
Overview		106	
Feed-through			
1.5 mm ²	D1.5/5.ADO.NF	110	
1.82 mm ²	D1.5/6.ADO.NF	111	
2.61 mm ²	D2.5/8.ADO.NF	112	
1.5 mm ²	D2.5/8.ADO.NF1	113	
4.32 mm ²	D4/8.ADO.NF	114	
Disconnect with plug			
1.82 mm ²	D1.5/6.S.ADO.NF	115	
2.61 mm ²	D2.5/8.S.ADO.NF	116	
Double deck			
1.82 mm ²	D1.5/6.D2.ADO.NF	117	
Component holder			
1.82 mm ²	D1.5/6.ADO.D2.NF	118	
Pluggable			
1.82 mm ²	D1.5/7.ADO-CPE.NF	1x ADO system - 1x pluggable	119
1.5 mm ²	D2.5/7.ADO-CPE.NF1	1x ADO system - 1x pluggable	120
1.82 mm ²	D1.5/7.2ADO-CPE.NF	2x ADO system - 1x pluggable	121
2.61 mm ²	D2.5/7.ADO-CPE.NF	1x ADO system - 1x pluggable	122
	D2.5/7.2ADO-CPE.NF	2x ADO system - 1x pluggable	123
4.32 mm ²	D4/7.ADO-CPE.NF	1x ADO system - 1x pluggable	124
	D4/7.2ADO-CPE.NF	2x ADO system - 1x pluggable	125
	D2.5/7.2CPE	1x pluggable - 1x pluggable	126
	D2.5/7.2CPE.CPE	1x pluggable - 1x pluggable	127
Female plugs			
1.82 mm ²	L 266 200 15	2 to 10 poles	128
	L 266 200 25	2 to 10 poles-with brackets	129
	L 277 200 15	2 to 6 poles	130
2.61 mm ²	L 267 200 15	2 to 10 poles	131
	L 267 200 25	2 to 10 poles	132
4.32 mm ²	L 276 200 15	4 and 5 poles	133
Male plugs			
1.82 mm ²	L 366 200 45	2 to 10 poles	134
2.61 mm ²	L 367 200 45	2 to 10 poles	135

Railway applications, terminal blocks

ADO System® IDC and pluggable technologies

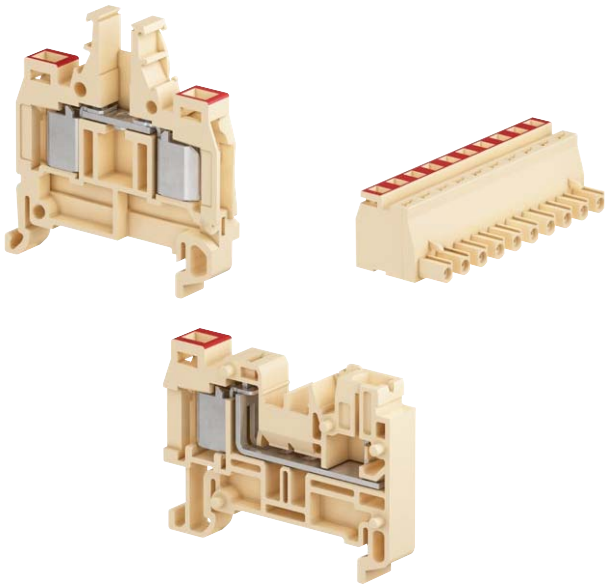

The fastest connection technology for rolling stock

The ADO system® technology based on insulation displacement (IDC) technology offers significant productivity savings as well as secure and reliable connection in case of vibration and shock.

Combined with the pluggable technology, it increases the productivity thanks to pre-produced plugs harnesses.



4



Reliable in harsh conditions

Continuous operation guaranteed for rolling stock

- Environmental tests: aging, corrosion, flammability, toxicity (I2F2, V0, HL3 R22)
- Mechanical tests: vibration and shock.



Cost effective solution

80% wiring time reduced compared to traditional technologies

- Asymmetrical design avoid mounting and wiring errors.
- Zero-retightening with our technologies.



Improve installation efficiency

Connection process simplified and secured

- Tool locked during the connection process
- Optimized wiring with pluggable technology
- Up to 2 conductors per ADO clamp.

Features

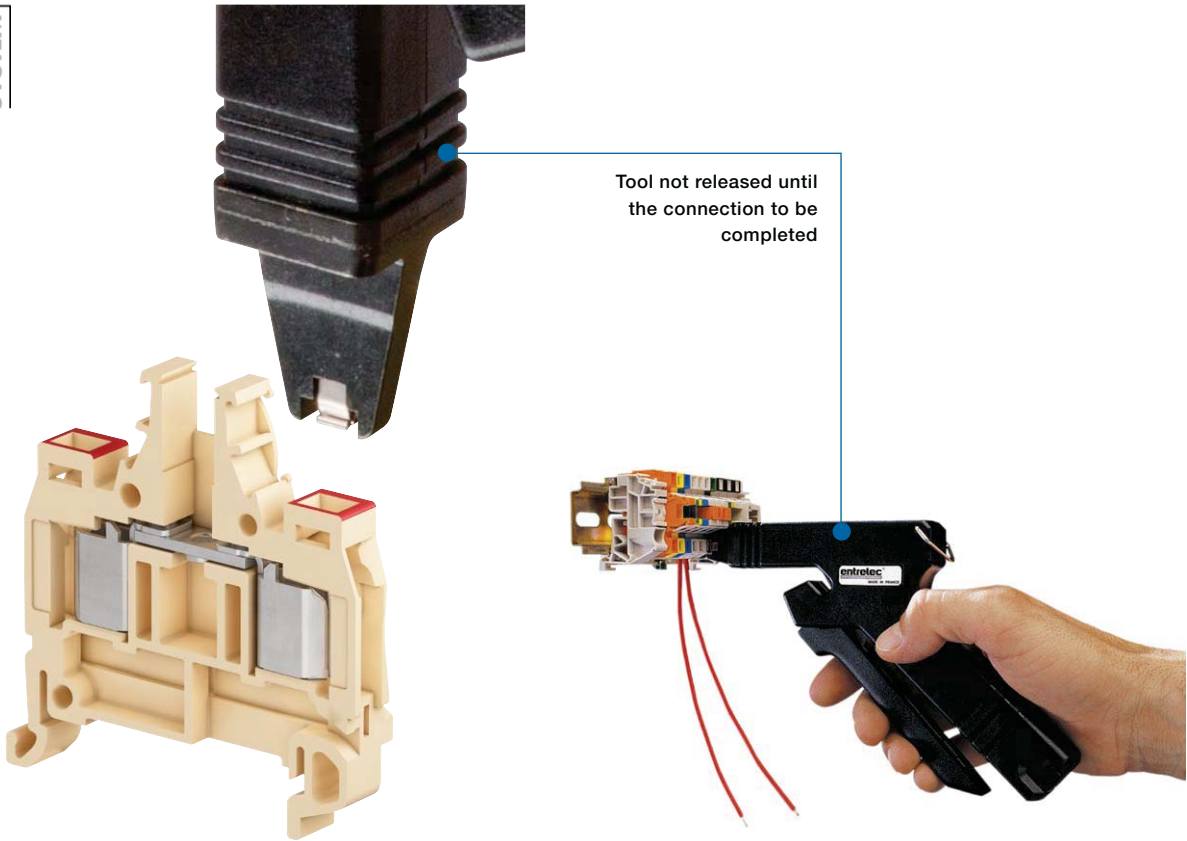

Tool not released until the connection to be completed

Contact lips: allows the electrical contact with a permanent cable contact pressure

Cone entry shape: allows the insulation cutting

Corrosion proof: contact points are wrapped by the insulation

First wire maintained in the clamp during the second wire cabling process

ADO System® jaw: "C shape" spring

Railway applications, terminal blocks

ADO System® IDC and pluggable technologies

Range overview from 1.5 mm² up to 4 mm² - 16 AWG up to 12 AWG

Feed-through

Red = 1.5 mm² / 16 AWG

Blue = 2.5 mm² / 14 AWG

Yellow = 4 mm² / 12 AWG

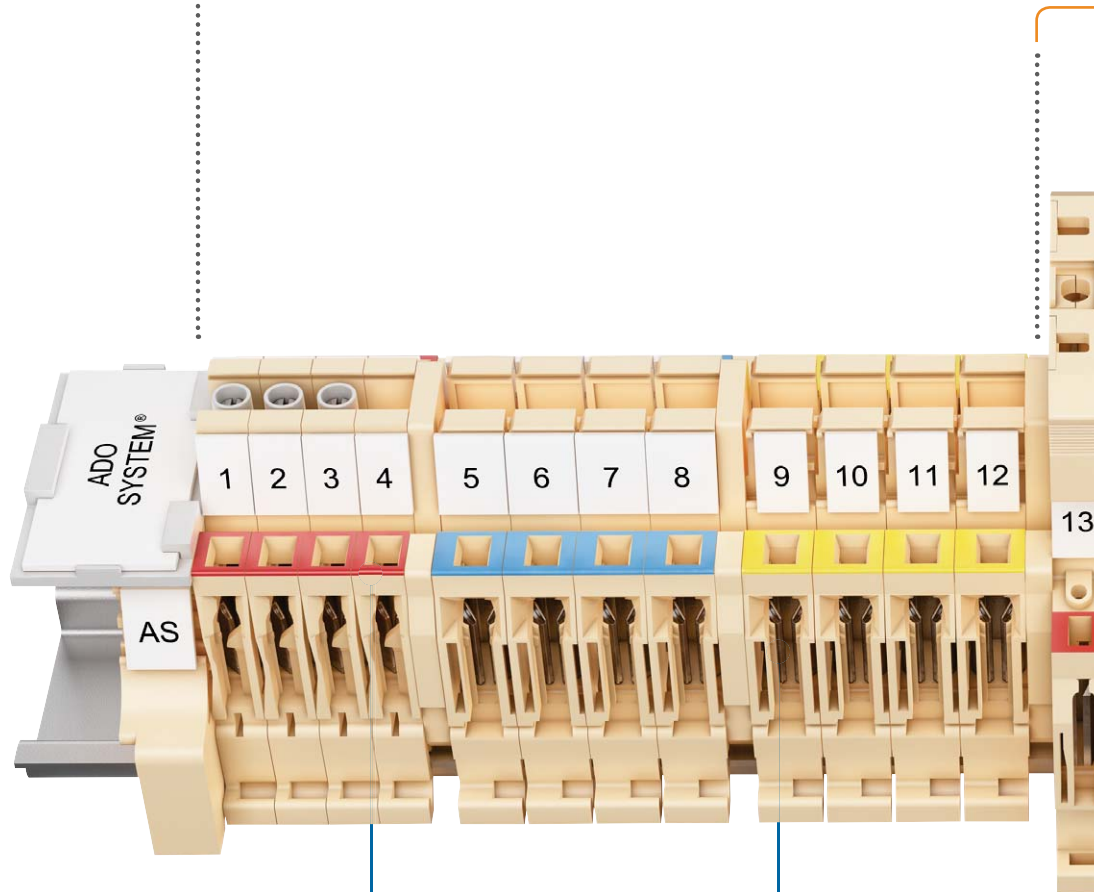

Specific color marking
Easy identification of the wire size

Connection of up to 2 wires
Save space by connecting
up to 2 conductors in 1 connection

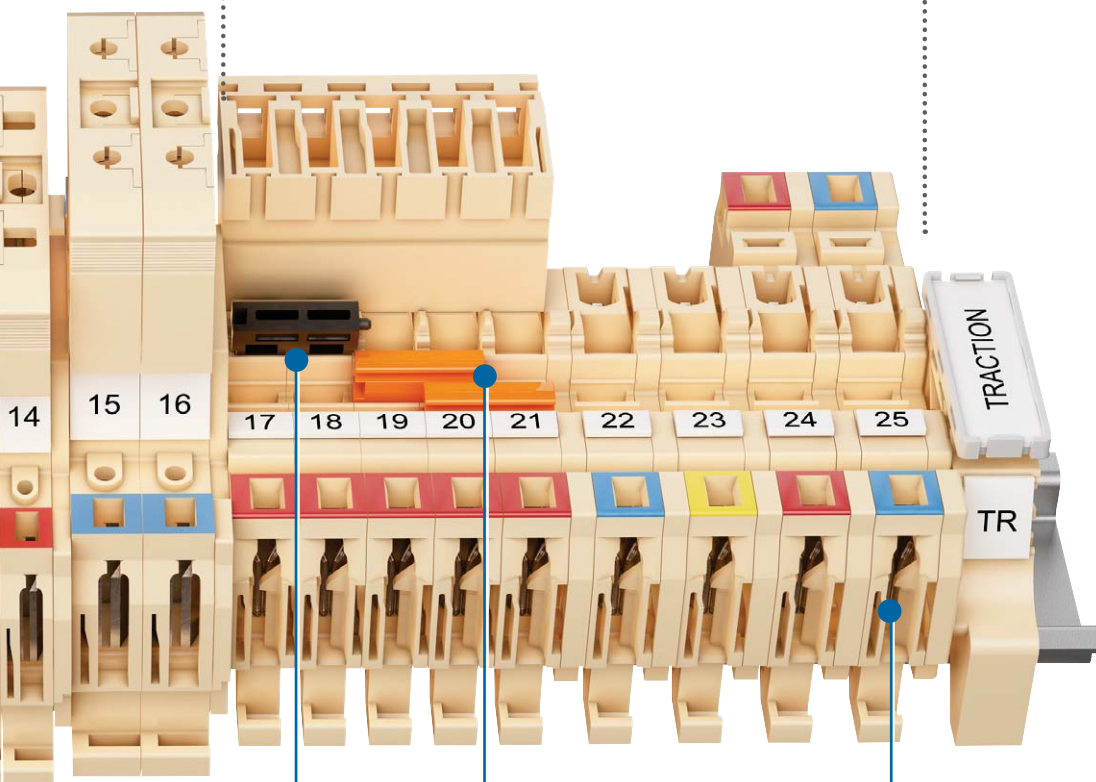
Component holder1.5 mm² / 16 AWG**Disconnect with plug**1.5 and 2.5 mm²
16 and 14 AWG**Pluggable**From 1.5 to 4 mm²
From 16 to 12 AWG**Locking lever**Secure against
accidental wire pulling**Double jumper channel**Plug-in insulated
jumpers**EN 50306 compatibility**The clamps are compatible
with thin insulated conductors



Railway applications, terminal blocks

ADO System® IDC and pluggable technologies



Feed-through

Section					
1.5 mm ²	D1.5/5.ADO.NF	D2.5/8.ADO.NF1	D1.5/6.ADO.NF		
1.82 mm ²				D2.5/8.ADO.NF	
2.61 mm ²					D4/8.ADO.NF
4.32 mm ²					



Pluggable

Feed-through: 1 ADO - 1 pluggable

Section				
1.5 mm ²		D2.5/7.ADO-CPE.NF1		
1.82 mm ²	D1.5/7.ADO-CPE.NF		D2.5/7.ADO-CPE.NF	
2.61 mm ²				D4/7.ADO-CPE.NF
4.32 mm ²				

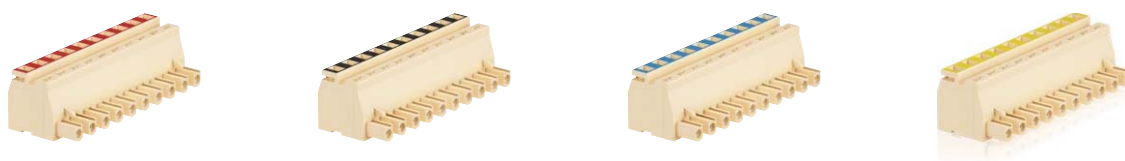

Female plugs for pluggable terminal blocks

Section				
1.5 mm ²		L 277 200 15		
1.82 mm ²	L 266 200 15	L 266 200 25	L 267 200 15	L 267 200 25
2.61 mm ²				
4.32 mm ²				L 276 200 15

Clamp -
 Channels for jumpering or testing -
 Test socket -
 Blown-fuse indicator



Double deck



D1.5/6.D2.ADO.NF

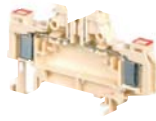

Disconnect with plug



D1.5/6.S.ADO.NF



D2.5/8.S.ADO.NF



Component holder



D1.5/6.ADO.D2.NF

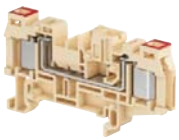

Feed-through: 2 ADO - 1 pluggable



D1.5/7.2ADO-CPE.NF

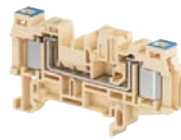

D2.5/7.2ADO-CPE.NF

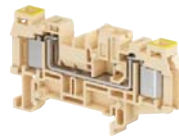

D4/7.2ADO-CPE.NF

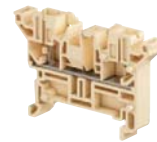

Feed-through: 2 pluggables



D2.5/7.2CPE
D2.5/7.2CPE
D2.5/7.2CPE
D2.5/7.2CPE



D2.5/7.CPE.CPE
D2.5/7.CPE.CPE
D2.5/7.CPE.CPE
D2.5/7.CPE.CPE



Male plugs



L 366 200 45



L 367 200 45

4

1SNC167092S0201

D1.5/5.ADO.NF IDC terminal blocks

Feed-through - ADO System® - 5 mm 0.197 in spacing

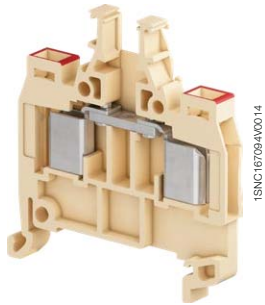

D1.5/5.ADO.NF

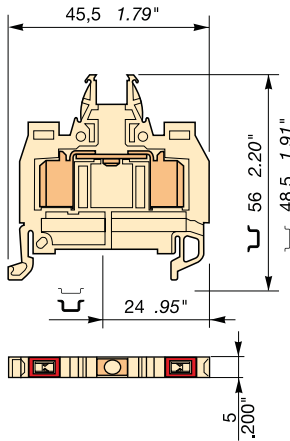

5 mm 0.197 in spacing

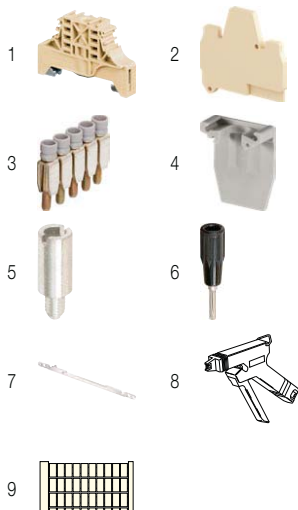

Description

- With the TE Connectivity ADO System®, experience the fastest and most reliable connection on the market,
- Designed for rolling stock applications exposed to severe constraints (vibrations, shocks etc.),
- Up to 2 wires per connection,
- Red marking to identify wire size.

Ordering details

Description	Color	Type	Part Numbers	Pkg qty	Weight (1 pce)
Feed-through	Beige <input type="checkbox"/>	D1.5/5.ADO.NF	1SNA400315R0100	50	5.00

Main technical data

Connecting capacity	NF F 63-808	NF F 63-296 NF F 63-826	EN 50306
ADO Flexible without ferrule	0.6 ... 1.34 mm²		0.5 ... 1.5 mm²
Rated current	17.5 A	16 A	
Rated short-time withstand current (1s)	180 A		
Rated voltage	1000 V	500 V	
Impulse withstand voltage	8000 V		
Protection	IP20		

Mounting instructions

Rail	TH 35-7.5, TH 35-15
Tool	ADO system tool

CE	RoHS	EAC
CE	RoHS	EAC

Accessories

Description	Color	Type	Part Numbers	Pkg qty	Weight (1 pce)
1 End stops	Beige <input type="checkbox"/>	BAM2	1SNA296351R0000	50	12.00
2 End sections	Beige <input type="checkbox"/>	FEMAD3	1SNA399802R0500	20	2.50
3 Jumper bars		BJMI5-2	1SNA176278R1600	10	3.30
		BJMI5-3	1SNA176279R1700	10	5.00
		BJMI5-4	1SNA176280R0500	10	6.70
		BJMI5-5	1SNA176281R2200	10	8.40
		BJMI5-10	1SNA176282R2300	10	16.90
4 Circuit separators	Grey <input type="checkbox"/>	SCAD5	1SNA199551R2000	10	0.30
5 Test sockets		AL2	1SNA163043R2100	50	0.90
		AL3	1SNA163261R0000	50	1.20
		FC2	1SNA007865R2600	100	2.00
6 Test plugs		CBM5	1SNA178745R1400	50	1
		CBM8	1SNA178746R1500	50	1
		OUPAD	1SNA178944R0400	1	205.00
7 Shield connectors		OUMAD	1SNA179466R0600	1	29.00
		RC55	1SNA231000R0700	10	5.20
8 Tools		RC55	1SNA230000R1200	10	2.90
9 Terminal block markers					

D1.5/6.ADO.NF IDC terminal blocks

Feed-through - ADO System® - 6 mm 0.236 in spacing

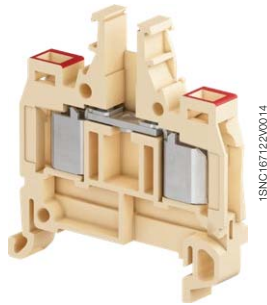

D1.5/6.ADO.NF

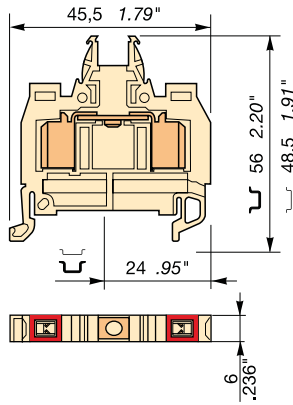

6 mm 0.236 in spacing

Description

- With the TE Connectivity ADO System®, experience the fastest and most reliable connection on the market,
- Designed for rolling stock applications exposed to severe constraints (vibrations, shocks etc.),
- Up to 2 wires per connection,
- Red marking to identify wire size.

Ordering details

Description	Color	Type	Part Numbers	Pkg qty	Weight (1 pce)
Feed-through	Beige	D1.5/6.ADO.NF	1SNA399730R1700	50	6.00

Main technical data

Connecting capacity	NF F 63-808	NF F 63-296 NF F 63-826	EN 50306	Rail	TH 35-7.5, TH 35-15
ADO Flexible without ferrule	0.6 ... 1.82 mm²		0.5 ... 1.5 mm²	Tool	ADO system tool
Rated current	17.5 A	16 A			
Rated short-time withstand current (1s)	180 A				
Rated voltage	1000 V	500 V			
Impulse withstand voltage	8000 V				
Protection	IP20				

Mounting instructions

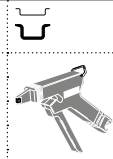

CE	RoHS	EAC			
CE	RoHS	EAC			



Accessories

Description	Color	Type	Part Numbers	Pkg qty	Weight (1 pce)
1 End stops	Beige	BAM2	1SNA296351R0000	50	12.00
2 End sections	Beige	FEMAD3	1SNA399802R0500	20	2.50
3 Jumper bars		BJMI6-2	1SNA176663R0000	10	4.40
		BJMI6-3	1SNA176664R0100	10	6.70
		BJMI6-4	1SNA176665R0200	10	8.90
		BJMI6-5	1SNA176666R0300	10	11.20
		BJMI6-10	1SNA176667R0400	10	22.40
		BJS6-20	1SNA174784R2000	10	26.70
4 Cross spacing jumpers		EL6	1SNA173627R2100	10	0.10
5 Circuit separators	Grey	SCAD	1SNA196896R0000	10	0.7
6 Test sockets		AL2	1SNA163043R2100	50	0.90
		AL3	1SNA163261R0000	50	1.20
7 Test plugs	Black	FC2	1SNA007865R2600	100	2.00
8 Shield connectors		CBM5	1SNA178745R1400	50	1
		CBM8	1SNA178746R1500	50	1
		OUPAD	1SNA178944R0400	1	205.00
9 Tools		OUMAD	1SNA179466R0600	1	29.00
		RC610	1SNA233000R0100	10	7.50
10 Terminal block markers		RC65	1SNA232000R0000	10	3.60

D2.5/8.ADO.NF IDC terminal blocks

Feed-through - ADO System® - 8 mm 0.315 in spacing

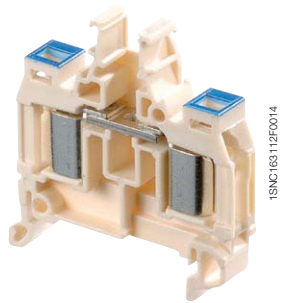

D2.5/8.ADO.NF

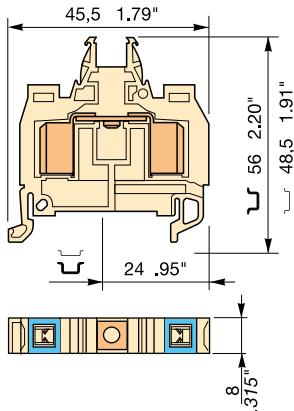

8 mm 0.315 in spacing



Description

- With the TE Connectivity ADO System®, experience the fastest and most reliable connection on the market,
- Designed for rolling stock applications exposed to severe constraints (vibrations, shocks etc.),
- Up to 2 wires per connection,
- Blue marking to identify wire size.

Ordering details

Description	Color	Type	Part Numbers	Pkg qty	Weight (1 pce) g
Feed-through	Beige	D2.5/8.ADO.NF	1SNA399736R0100	50	9.00

Main technical data

Connecting capacity	NF F 63-808	NF F 63-296 NF F 63-826	EN 50306
ADO Flexible without ferrule	0.93 ... 2.61 mm²	1 ... 2.5 mm²	
Rated current	24 A	16 A	
Rated short-time withstand current (1s)	300 A		
Rated voltage	1000 V	500 V	
Impulse withstand voltage	8000 V		
Protection	IP20		

Mounting instructions

Rail		TH 35-7.5, TH 35-15
Tool		ADO system tool

CE	RoHS	EAC							
CE	RoHS	EAC							

Accessories

Description	Color	Type	Part Numbers	Pkg qty	Weight (1 pce) g	
1 End stops	Beige	BAM2	1SNA296351R0000	50	12.00	
2 End sections	Beige	FEMAD3	1SNA399802R0500	20	2.50	
3 Jumper bars		2 poles	BJMI8-2	1SNA176669R1600	10	4.50
		3 poles	BJMI8-3	1SNA176670R1300	10	6.00
		4 poles	BJMI8-4	1SNA176671R0000	10	10.00
		5 poles	BJMI8-5	1SNA176672R0100	10	12.20
		10 poles	BJMI8-10	1SNA176673R0200	10	20.00
4 Cross spacing jumpers		2 poles	EL6	1SNA173627R2100	10	0.10
5 Circuit separators	Grey	0 mm	SCAD	1SNA196896R0000	10	0.7
6 Test sockets		DIA 2 mm 0.079 in	AL2	1SNA163043R2100	50	0.90
		DIA 3 mm 0.120 in	AL3	1SNA163261R0000	50	1.20
		DIA 2 mm 0.079 in	FC2	1SNA007865R2600	100	2.00
7 Test plugs	Black	DIA 2 mm 0.079 in	FC4	1SNA167860R0100	10	10.00
		DIA 4 mm 0.157 in	FC4	1SNA167860R0100	10	10.00
		Semi automatic tool	OUPAD	1SNA178944R0400	1	205.00
8 Tools		Hand tool	OUMAD	1SNA179466R0600	1	29.00
			RC810	1SNA234000R0200	10	8.20
9 Terminal block markers	White	Blank card				

D2.5/8.ADO.NF1 IDC terminal blocks

Feed-through - ADO System® - 8 mm 0.315 in spacing

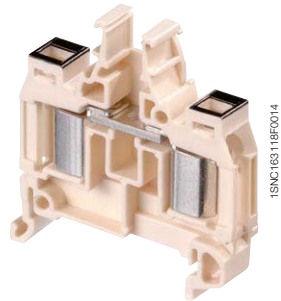

D2.5/8.ADO.NF1

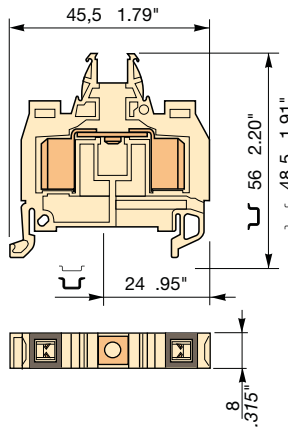

8 mm 0.315 in spacing



Description

- With the TE Connectivity ADO System®, experience the fastest and most reliable connection on the market,
- Designed for rolling stock applications exposed to severe constraints (vibrations, shocks etc.),
- Up to 2 wires per connection,
- Black marking to identify wire size.

Ordering details

Description	Color	Type	Part Numbers	Pkg qty	Weight (1 pce) g
Feed-through	Beige <input type="checkbox"/>	D2.5/8.ADO.NF1	1SNA399749R2600	50	9.00

Main technical data

Connecting capacity	NF F 63-808	NF F 63-296 NF F 63-826	EN 50306	Rail	TH 35-7.5, TH 35-15
ADO Flexible without ferrule		1.5 mm²		Tool	ADO system tool
Rated current	24 A	16 A			
Rated short-time withstand current (1s)	180 A				
Rated voltage	1000 V	500 V			
Impulse withstand voltage	8000 V				
Protection	IP20				

Mounting instructions

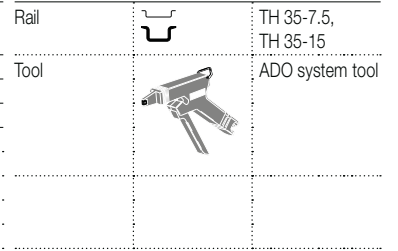

<input type="checkbox"/> CE	<input type="checkbox"/> RoHS	<input type="checkbox"/> EAC			
CE	RoHS	EAC			

Accessories

Description	Color	Type	Part Numbers	Pkg qty	Weight (1 pce) g
1 End stops	Beige <input type="checkbox"/>	BAM2	1SNA296351R0000	50	12.00
2 End sections	Beige <input type="checkbox"/>	FEMAD3	1SNA399802R0500	20	2.50
3 Jumper bars		BJMI8-2	1SNA176669R1600	10	4.50
		BJMI8-3	1SNA176670R1300	10	6.00
		BJMI8-4	1SNA176671R0000	10	10.00
		BJMI8-5	1SNA176672R0100	10	12.20
		BJMI8-10	1SNA176673R0200	10	20.00
4 Cross spacing jumpers		EL6	1SNA173627R2100	10	0.10
5 Circuit separators	Grey <input type="checkbox"/>	SCAD	1SNA196896R0000	10	0.7
6 Test sockets		AL2	1SNA163043R2100	50	0.90
		AL3	1SNA163261R0000	50	1.20
7 Test plugs	Black <input type="checkbox"/>	FC2	1SNA007865R2600	100	2.00
	White <input type="checkbox"/>	FC4	1SNA167860R0100	10	10.00
8 Tools		OUPAD	1SNA178944R0400	1	205.00
		OUMAD	1SNA179466R0600	1	29.00
9 Terminal block markers	White <input type="checkbox"/>	RC810	1SNA234000R0200	10	8.20

D4/8.ADO.NF IDC terminal blocks

Feed-through - ADO System® - 8 mm 0.315 in spacing

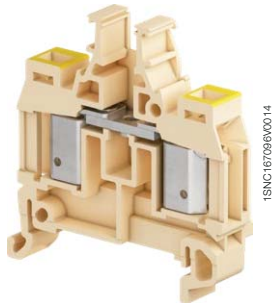

D4/8.ADO.NF

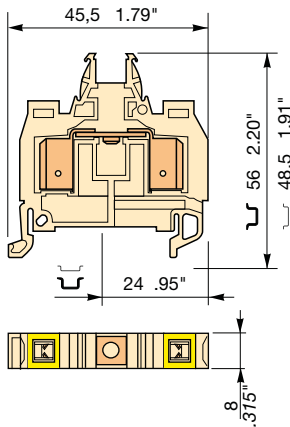

8 mm 0.315 in spacing



Description

- With the TE Connectivity ADO System®, experience the fastest and most reliable connection on the market,
- Designed for rolling stock applications exposed to severe constraints (vibrations, shocks etc.),
- Up to 2 wires per connection,
- Yellow marking to identify wire size.

Ordering details

Description	Color	Type	Part Numbers	Pkg qty	Weight (1 pce) g
Feed-through	Beige <input type="checkbox"/>	D4/8.ADO.NF	1SNA399748R2500	50	9.00

Main technical data

Connecting capacity	NF F 63-808	NF F 63-296 NF F 63-826	EN 50306
ADO Flexible without ferrule	4.32 mm²		
Rated current	32 A	16 A	
Rated short-time withstand current (1s)	480 A		
Rated voltage	1000 V	500 V	
Impulse withstand voltage	8000 V		
Protection	IP20		

Mounting instructions

Rail		TH 35-7.5, TH 35-15
Tool		ADO system tool

CE	RoHS	EAC							
CE	RoHS	EAC							

Accessories

Description	Color	Type	Part Numbers	Pkg qty	Weight (1 pce) g
1 End stops	Beige <input type="checkbox"/>	BAM2	1SNA296351R0000	50	12.00
2 End sections	Beige <input type="checkbox"/>	FEMAD3	1SNA399802R0500	20	2.50
3 Jumper bars		BJMI8-2	1SNA176669R1600	10	4.50
		BJMI8-3	1SNA176670R1300	10	6.00
		BJMI8-4	1SNA176671R0000	10	10.00
		BJMI8-5	1SNA176672R0100	10	12.20
		BJMI8-10	1SNA176673R0200	10	20.00
4 Cross spacing jumpers		EL6	1SNA173627R2100	10	0.10
5 Circuit separators	Grey <input type="checkbox"/>	SCAD	1SNA196896R0000	10	0.7
6 Test sockets		AL2	1SNA163043R2100	50	0.90
		AL3	1SNA163261R0000	50	1.20
7 Test plugs	Black <input type="checkbox"/>	FC2	1SNA007865R2600	100	2.00
	White <input type="checkbox"/>	FC4	1SNA167860R0100	10	10.00
8 Tools		OUPAD	1SNA178944R0400	1	205.00
		OUMAD	1SNA179466R0600	1	29.00
9 Terminal block markers	White <input type="checkbox"/>	RC810	1SNA234000R0200	10	8.20

D1.5/6.S.ADO.NF IDC terminal blocks

Disconnect with plug - ADO System® - 6 mm 0.236 in spacing

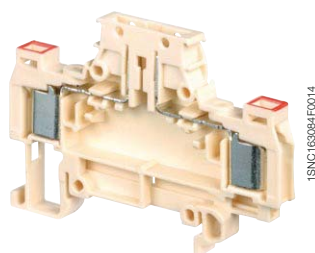

D1.5/6.S.ADO.NF

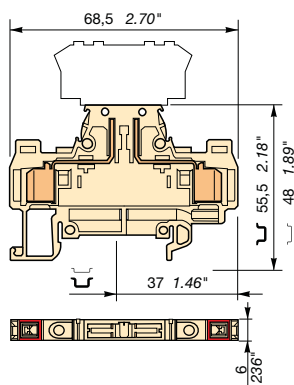

6 mm 0.236 in spacing

Description

- Ease your disconnect operations with the disconnect component holder plug,
- With the TE Connectivity ADO System®, experience the fastest and most reliable connection on the market,
- Designed for rolling stock applications exposed to severe constrains (vibrations, shocks etc.),
- Up to 2 wires per connection,
- Red marking to identify wire size.

Ordering details

Description	Color	Type	Part Numbers	Pkg qty	Weight (1 pce)
Disconnect With 2 test sockets DIA 2 mm 0.079 in	Beige <input type="checkbox"/>	D1.5/6.S.ADO.NF	1SNA400083R2500	50	8.00

Main technical data

Connecting capacity	NF F 63-808	NF F 63-296 NF F 63-826	EN 50306
ADO Flexible without ferrule	0.6 ... 1.82 mm²		0.5 ... 1.5 mm²
	IEC	NF F 61-017	
Rated current	10 A		
Rated short-time withstand current (1s)	180 A		
Rated voltage	500 V		
Impulse withstand voltage	6000 V		
Protection	IP20		

Mounting instructions

Rail		TH 35-7.5, TH 35-15
Tool		ADO system tool

--	--	--	--	--	--	--	--	--	--

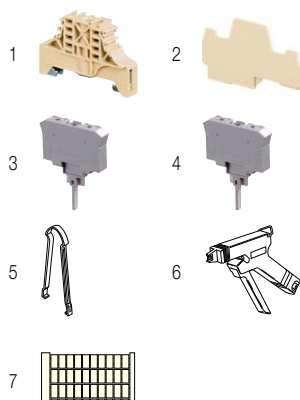

Accessories

Description	Color	Type	Part Numbers	Pkg qty	Weight (1 pce)
1 End stops 10 mm 0.394 in	Beige <input type="checkbox"/>	BAM2	1SNA296351R0000	50	12.00
2 End sections 2 mm 0.079 in	Beige <input type="checkbox"/>	FEDAD5	1SNA399804R0700	20	2.70
3 Component plugs With solder leads and screws	Beige <input type="checkbox"/>	BNSV62	1SNA196854R1500	50	6.00
		BNSV62-1	1SNA400142R0400	50	6.00
		BNF652	1SNA196998R1600	50	6.00
4 Short circuit plugs For 5x20 and 5x25 fuses	Beige <input type="checkbox"/>	BNC62	1SNA196853R1400	50	7.00
5 Extraction tools Equipped with linking bar		EXBN2	1SNA171018R2000	1	
6 Tools Semi automatic tool		OUPAD	1SNA178944R0400	1	205.00
		OUMAD	1SNA179466R0600	1	29.00
7 Terminal block markers Blank card	White <input type="checkbox"/>	RC610	1SNA233000R0100	10	7.50

D2.5/8.S.ADO.NF IDC terminal blocks

Disconnect with plug - ADO System® - 8 mm 0.315 in spacing

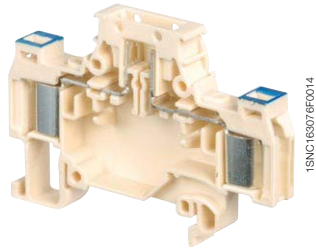

1SNC163076E0014

D2.5/8.S.ADO.NF

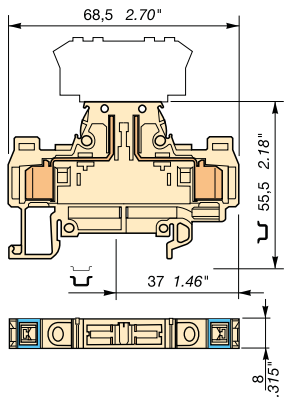

8 mm 0.315 in spacing

Description

- Ease your disconnect operations with the disconnect component holder plug,
- With the TE Connectivity ADO System®, experience the fastest and most reliable connection on the market,
- Designed for rolling stock applications exposed to severe constraints (vibrations, shocks etc.),
- Up to 2 wires per connection,
- Blue marking to identify wire size.

Ordering details

Description	Color	Type	Part Numbers	Pkg qty	Weight (1 pce) g
Disconnect With 2 test sockets DIA 2 mm 0.079 in	Beige <input type="checkbox"/>	D2.5/8.S.ADO.NF	1SNA399752R1100	50	11.00

Main technical data

Connecting capacity	NF F 63-808	NF F 63-296 NF F 63-826	EN 50306
ADO Flexible without ferrule	0.93 ... 2.61 mm²		1 ... 2.5 mm²
Rated current	IEC 15 A	NF F 61-017	
Rated short-time withstand current (1s)	300 A		
Rated voltage	500 V		
Impulse withstand voltage	6000 V		
Protection	IP20		

Mounting instructions

Rail		TH 35-7.5, TH 35-15
Tool		ADO system tool

--	--	--	--	--	--	--	--	--	--

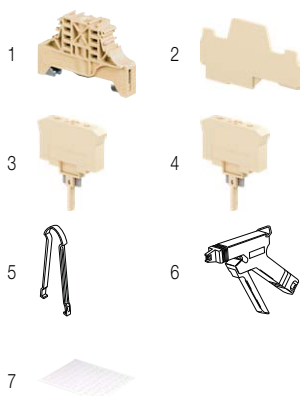

Accessories

Description	Color	Type	Part Numbers	Pkg qty	Weight (1 pce) g
1 End stops 10 mm 0.394 in	Beige <input type="checkbox"/>	BAM2	1SNA296351R0000	50	12.00
2 End sections 2 mm 0.079 in	Beige <input type="checkbox"/>	FEDAD5	1SNA399804R0700	20	2.70
3 Component plugs For 5x20 and 5x25 fuses With solder leads and screws	Beige <input type="checkbox"/>	BNF52	1SNA196924R0300	50	8.00
		BNSV82	1SNA196927R0600	50	8.00
4 Short circuit plugs Equipped with linking bar	Beige <input type="checkbox"/>	BNCT82	1SNA196926R0500	50	9.00
5 Extraction tools		EXBN2	1SNA171018R2000	1	
6 Tools Semi automatic tool		OUPAD	1SNA178944R0400	1	205.00
		OUMAD	1SNA179466R0600	1	29.00
7 Terminal block markers Blank card	White <input type="checkbox"/>	RC810	1SNA234000R0200	10	8.20

D1.5/6.D2.ADO.NF IDC terminal blocks

Feed-through - ADO System® - 6 mm 0.236 in spacing



1.82 mm²

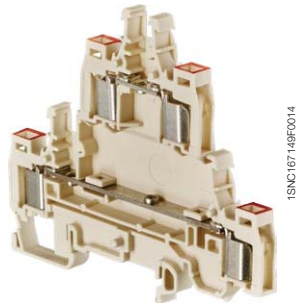

1SNC167149F0014

D1.5/6.D2.ADO.NF

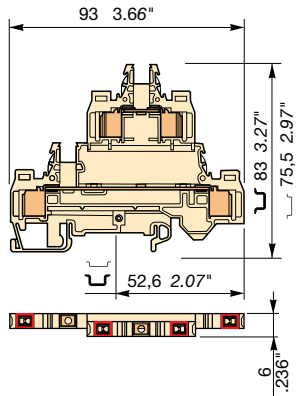

6 mm 0.236 in spacing

Description

- Save space with double deck terminal blocks: 2 independent circuits connected in just 6 mm 0.236 in spacing,
- With the TE Connectivity ADO System®, experience the fastest and most reliable connection on the market,
- Designed for rolling stock applications exposed to severe constraints (vibrations, shocks etc.),
- Up to 2 wires per connection,
- Red marking to identify wire size.

Ordering details

Description	Color	Type	Part Numbers	Pkg qty	Weight (1 pce) g
Feed-through	Beige <input type="checkbox"/>	D1.5/6.D2.ADO.NF	1SNA399742R1700	50	18.00

Main technical data

Connecting capacity	NF F 63-808	NF F 63-296 NF F 63-826	EN 50306
ADO Flexible without ferrule	0.6 ... 1.82 mm ²		0.5 ... 1.5 mm ²
	IEC	NF F 61-017	
Rated current	17.5 A	16 A	
Rated short-time withstand current (1s)	180 A		
Rated voltage	800 V	500 V	
Impulse withstand voltage	6000 V		
Protection	IP20		

Mounting instructions

Rail		TH 35-7.5, TH 35-15
Tool		ADO system tool

	RoHS <input type="checkbox"/>																			
--	-------------------------------	--	--	--	--	--	--	--	--	--	--	--	--	--	--	--	--	--	--	--



Accessories

Description	Color	Type	Part Numbers	Pkg qty	Weight (1 pce) g
1 End stops	Grey <input type="checkbox"/>	BADH	1SNA116900R2700	50	20.00
2 End sections	Beige <input type="checkbox"/>	FED2AD2	1SNA399803R0600	20	7.00
3 Jumper bars		BJMI6-2	1SNA176663R0000	10	4.40
		BJMI6-3	1SNA176664R0100	10	6.70
		BJMI6-4	1SNA176665R0200	10	8.90
		BJMI6-5	1SNA176666R0300	10	11.20
		BJMI6-10	1SNA176667R0400	10	22.40
		BJS6-20	1SNA174784R2000	10	26.70
4 Circuit separators	Grey <input type="checkbox"/>	SCAD	1SNA196896R0000	10	0.7
5 Test sockets		AL2	1SNA163043R2100	50	0.90
		AL3	1SNA163261R0000	50	1.20
6 Test plugs	Black <input type="checkbox"/>	FC2	1SNA007865R2600	100	2.00
7 Tools		OUPAD	1SNA178944R0400	1	205.00
		OUMAD	1SNA179466R0600	1	29.00
8 Terminal block markers	White <input type="checkbox"/>	RC610	1SNA233000R0100	10	7.50
		RC65	1SNA232000R0000	10	3.60

1SNC167037S0201

D1.5/6.ADO.D2.NF IDC terminal blocks

Component holder - ADO System® - 6 mm 0.236 in spacing

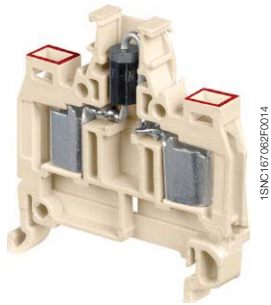

D1.5/6.ADO.D2.NF

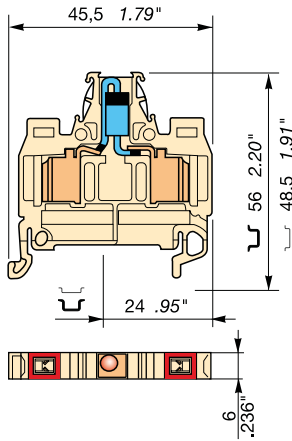

6 mm 0.236 in spacing

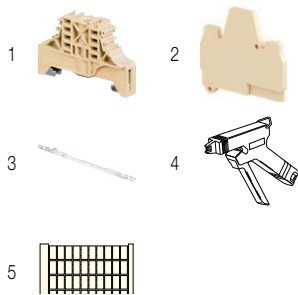

Description

- Terminal block equipped with a 1N5408 diode in series,
- With the TE Connectivity ADO System®, experience the fastest and most reliable connection on the market,
- Designed for rolling stock applications exposed to severe constraints (vibrations, shocks etc.),
- Up to 2 wires per connection,
- Red marking to identify wire size.

Ordering details

Description	Color	Type	Part Numbers	Pkg qty	Weight (1 pce)
Component holder Equipped with 1N5408 diode	Beige <input type="checkbox"/>	D1.5/6.ADO.D2.NF	1SNA399916R2600	50	7.00

Main technical data

Connecting capacity	NF F 63-808	NF F 63-296 NF F 63-826	EN 50306
ADO Flexible without ferrule	0.6 ... 1.82 mm²		0.5 ... 1.5 mm²
Rated current	IEC 1 A		NF F 61-017
Rated short-time withstand current (1s)			
Rated voltage	80 V		
Impulse withstand voltage			
Protection	IP20		

Mounting instructions

	Rail	TH 35-7.5, TH 35-15
Tool		ADO system tool

--	--	--

Accessories

Description	Color	Type	Part Numbers	Pkg qty	Weight (1 pce)
1 End stops 10 mm 0.394 in	Beige <input type="checkbox"/>	BAM2	1SNA296351R0000	50	12.00
2 End sections 3 mm 0.118 in	Beige <input type="checkbox"/>	FEMAD3	1SNA399802R0500	20	2.50
3 Shield connectors		CBM5	1SNA178745R1400	50	1
		CBM8	1SNA178746R1500	50	1
4 Tools Semi automatic tool Hand tool		OUPAD	1SNA178944R0400	1	205.00
		OUMAD	1SNA179466R0600	1	29.00
5 Terminal block markers Blank card	White <input type="checkbox"/>	RC610	1SNA233000R0100	10	7.50
		RC65	1SNA232000R0000	10	3.60

D1.5/7.ADO-CPE.NF pluggable terminal blocks

Feed-through - ADO System® - 7.62 mm 0.3 in spacing

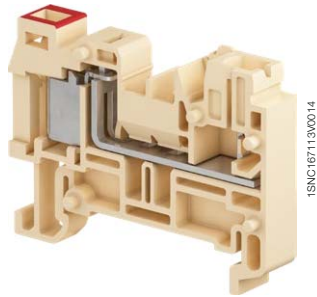

D1.5/7.ADO-CPE.NF

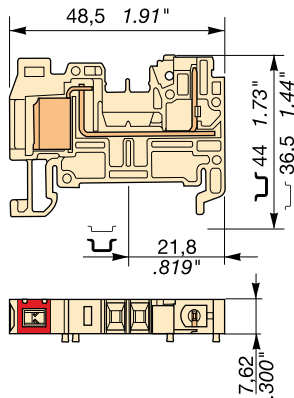

7.62 mm 0.3 in spacing

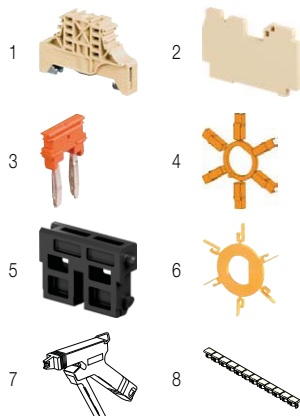

Description

- Increase your productivity with pluggable terminal blocks: possibility of pre-produced plugs harnesses, time saving plug & play assembly,
- With the TE Connectivity ADO System®, experience the fastest and most reliable connection on the market,
- Designed for rolling stock applications exposed to severe constrains (vibrations, shocks etc.),
- Up to 2 wires per connection,
- Red marking to identify wire size.

Ordering details

Description	Color	Type	Part Numbers	Pkg qty	Weight (1 pce) g
1 ADO - 1 pluggable 1 circuit	Beige	D1.5/7.ADO-CPE.NF	1SNA400153R0700	50	8.40

Main technical data

Connecting capacity	NF F 63-808	NF F 63-296 NF F 63-826	EN 50306
ADO Flexible without ferrule	0.6 ... 1.82 mm²		0.5 ... 1.5 mm²
	IEC	NF F 61-017	
Rated current	16 A	16 A	
Rated short-time withstand current (1s)	180 A		
Rated voltage	500 V	500 V	
Impulse withstand voltage			
Protection	IP20		

Mounting instructions

Rail		TH 35-7.5, TH 35-15
Tool		ADO system tool

CE	RoHS	EAC																	
----	------	-----	--	--	--	--	--	--	--	--	--	--	--	--	--	--	--	--	--

Compatible products



Accessories

Description	Color	Type	Part Numbers	Pkg qty	Weight (1 pce) g	
1 End stops 10 mm 0.394 in	Beige	BAM2	1SNA296351R0000	50	12.00	
2 End sections 2.9 mm 0.114 in	Beige	FECPE.ADO	1SNA400019R0400	20	2.20	
3 Jumper bars	Orange	10 poles	BJE762.10	1SNA290453R0500	10	24.00
		2 poles	BJE762.2	1SNA290451R0300	10	5.30
		5 poles	BJE762.5	1SNA290452R0400	10	15.40
4 Insulating tips For jumper bars type BJE762	Orange	EIP	1SNA290454R0600	10	100.00	
5 Locking devices	Black	VRADO.CPE7	1SNA400063R0000	20	0.40	
6 Coding pegs	Yellow	COCE	1SNA199321R2100	10	1.00	
7 Tools		Semi automatic tool	OUPAD	1SNA178944R0400	1	205.00
		Hand tool	OUMAD	1SNA179466R0600	1	29.00
8 Terminal block markers Blank strip marker	White	RB-12W7	1SNA290455R0700	50	6.00	

D2.5/7.ADO-CPE.NF1 pluggable terminal blocks

Feed-through - ADO System® - 7.62 mm 0.3 in spacing

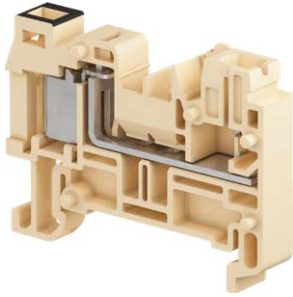

1SNC1671190014

D2.5/7.ADO-CPE.NF1

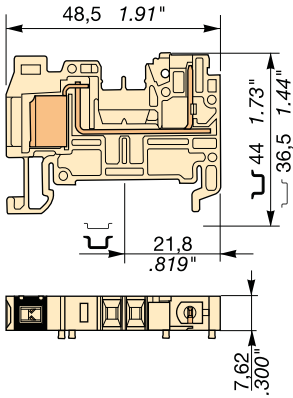

7.62 mm 0.3 in spacing

Description

- Increase your productivity with pluggable terminal blocks: possibility of pre-produced plugs harnesses, time saving plug & play assembly,
- With the TE Connectivity ADO System®, experience the fastest and most reliable connection on the market,
- Designed for rolling stock applications exposed to severe constraints (vibrations, shocks etc.),
- Up to 2 wires per connection,
- Black marking to identify wire size.

Ordering details

Description	Color	Type	Part Numbers	Pkg qty	Weight (1 pce)
1 ADO - 1 pluggable 1 circuit	Beige	D2.5/7.ADO-CPE.NF1	1SNA400156R0200	50	8.40

Main technical data

Connecting capacity	NF F 63-808	NF F 63-296 NF F 63-826	EN 50306
ADO Flexible without ferrule		1.5 mm²	
	IEC	NF F 61-017	
Rated current	24 A	16 A	
Rated short-time withstand current (1s)	180 A		
Rated voltage	500 V	500 V	
Impulse withstand voltage			
Protection	IP20		

Mounting instructions

Rail		TH 35-7.5, TH 35-15
Tool		ADO system tool

CE	RoHS	EAC									
CE	RoHS	EAC									

Compatible products



Accessories

Description	Color	Type	Part Numbers	Pkg qty	Weight (1 pce)
1 End stops 10 mm 0.394 in	Beige	BAM2	1SNA296351R0000	50	12.00
2 End sections 2.9 mm 0.114 in	Beige	FECPE.ADO	1SNA400019R0400	20	2.20
3 Jumper bars 10 poles	Orange	BJE762.10	1SNA290453R0500	10	24.00
2 poles		BJE762.2	1SNA290451R0300	10	5.30
5 poles		BJE762.5	1SNA290452R0400	10	15.40
4 Insulating tips For jumper bars type BJE762	Orange	EIP	1SNA290454R0600	10	100.00
5 Locking devices	Black	VRADO.CPE7	1SNA400063R0000	20	0.40
6 Coding pegs	Yellow	COCE	1SNA199321R2100	10	1.00
7 Tools Semi automatic tool		OUPAD	1SNA178944R0400	1	205.00
Hand tool		OUMAD	1SNA179466R0600	1	29.00
8 Terminal block markers Blank strip marker	White	RB-12W7	1SNA290455R0700	50	6.00

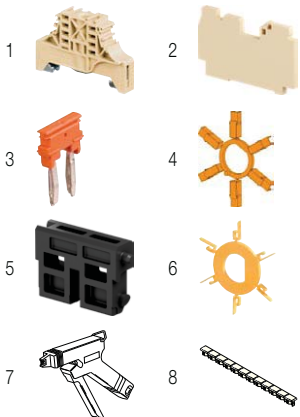

D1.5/7.2ADO-CPE.NF pluggable terminal blocks

Feed-through - ADO System® - 7.62 mm 0.3 in spacing

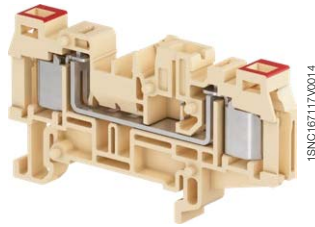

D1.5/7.2ADO-CPE.NF

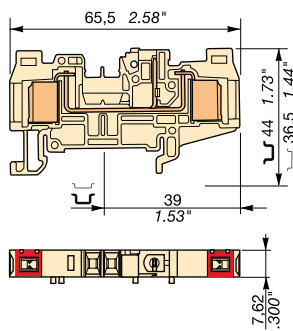

7.62 mm 0.3 in spacing

Description

- Increase your productivity with pluggable terminal blocks: possibility of pre-produced plugs harnesses, time saving plug & play assembly,
- With the TE Connectivity ADO System®, experience the fastest and most reliable connection on the market,
- Designed for rolling stock applications exposed to severe constrains (vibrations, shocks etc.),
- Up to 2 wires per connection,
- Red marking to identify wire size.

Ordering details

Description	Color	Type	Part Numbers	Pkg qty	Weight (1 pce) g
2 ADO - 1 pluggable 1 circuit	Beige	D1.5/7.2ADO-CPE.NF	1SNA400154R0000	50	11.00

Main technical data

Connecting capacity	NF F 63-808	NF F 63-296 NF F 63-826	EN 50306	Mounting instructions
ADO Flexible without ferrule	0.6 ... 1.82 mm²	0.5 ... 1.5 mm²		Rail TH 35-7.5, TH 35-15 Tool ADO system tool
	IEC	NF F 61-017		
Rated current	16 A	16 A		
Rated short-time withstand current (1s)	180 A			
Rated voltage	500 V	500 V		
Impulse withstand voltage				
Protection	IP20			
CE	RoHS	EAC		

Compatible products

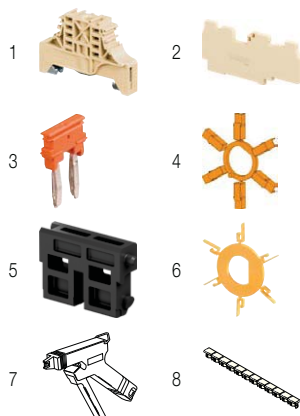

Accessories

Description	Color	Type	Part Numbers	Pkg qty	Weight (1 pce) g
1 End stops 10 mm 0.394 in	Beige	BAM2	1SNA296351R0000	50	12.00
2 End sections 2.9 mm 0.114 in	Beige	FECPE.2ADO	1SNA400018R0300	20	2.20
3 Jumper bars 10 poles 2 poles 5 poles	Orange	BJE762.10 BJE762.2 BJE762.5	1SNA290453R0500 1SNA290451R0300 1SNA290452R0400	10 10 10	24.00 5.30 15.40
4 Insulating tips For jumper bars type BJE762	Orange	EIP	1SNA290454R0600	10	100.00
5 Locking devices	Black	VRADO.CPE7	1SNA400063R0000	20	0.40
6 Coding pegs	Yellow	COCE	1SNA199321R2100	10	1.00
7 Tools Semi automatic tool Hand tool		OUPAD OUMAD	1SNA178944R0400 1SNA179466R0600	1 1	205.00 29.00
8 Terminal block markers Blank strip marker	White	RB-12W7	1SNA290455R0700	50	6.00

D2.5/7.ADO-CPE.NF pluggable terminal blocks

Feed-through - ADO System® - 7.62 mm 0.3 in spacing

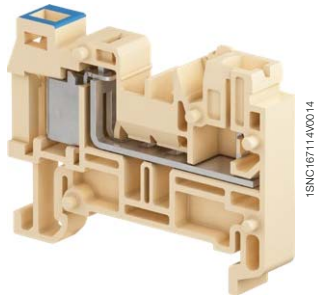

D2.5/7.ADO-CPE.NF

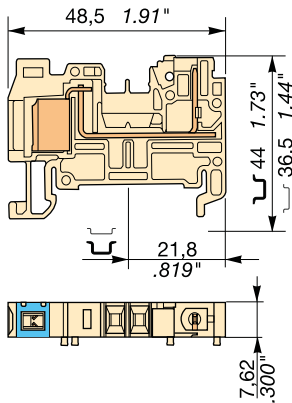

7.62 mm 0.3 in spacing

Description

- Increase your productivity with pluggable terminal blocks: possibility of pre-produced plugs harnesses, time saving plug & play assembly,
- With the TE Connectivity ADO System®, experience the fastest and most reliable connection on the market,
- Designed for rolling stock applications exposed to severe constraints (vibrations, shocks etc.),
- Up to 2 wires per connection,
- Blue marking to identify wire size.

Ordering details

Description	Color	Type	Part Numbers	Pkg qty	Weight (1 pce)
1 ADO - 1 pluggable 1 circuit	Beige	D2.5/7.ADO-CPE.NF	1SNA400061R0600	50	8.40

Main technical data

Connecting capacity	NF F 63-808	NF F 63-296 NF F 63-826	EN 50306
ADO Flexible without ferrule	0.93 ... 2.61 mm²	1 ... 2.5 mm²	
Rated current	24 A	16 A	
Rated short-time withstand current (1s)	300 A		
Rated voltage	500 V	500 V	
Impulse withstand voltage			
Protection	IP20		

Mounting instructions

Rail		TH 35-7.5, TH 35-15
Tool		ADO system tool

--	--	--	--	--	--	--	--	--	--	--	--	--	--	--	--	--	--	--	--

Compatible products



Accessories

Description	Color	Type	Part Numbers	Pkg qty	Weight (1 pce)
1 End stops 10 mm 0.394 in	Beige	BAM2	1SNA296351R0000	50	12.00
2 End sections 2.9 mm 0.114 in	Beige	FECPE.ADO	1SNA400019R0400	20	2.20
3 Jumper bars 10 poles 2 poles 5 poles	Orange	BJE762.10 BJE762.2 BJE762.5	1SNA290453R0500 1SNA290451R0300 1SNA290452R0400	10 10 10	24.00 5.30 15.40
4 Insulating tips For jumper bars type BJE762	Orange	EIP	1SNA290454R0600	10	100.00
5 Locking devices	Black	VRADO.CPE7	1SNA400063R0000	20	0.40
6 Coding pegs	Yellow	COCE	1SNA199321R2100	10	1.00
7 Tools Semi automatic tool Hand tool		OUPAD OUMAD	1SNA178944R0400 1SNA179466R0600	1 1	205.00 29.00
8 Terminal block markers Blank strip marker	White	RB-12W7	1SNA290455R0700	50	6.00

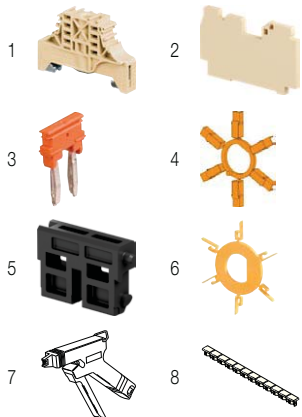

D2.5/7.2ADO-CPE.NF pluggable terminal blocks

Feed-through - ADO System® - 7.62 mm 0.3 in spacing



2.61 mm²

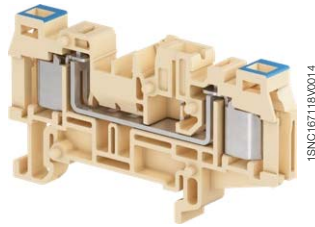

D2.5/7.2ADO-CPE.NF

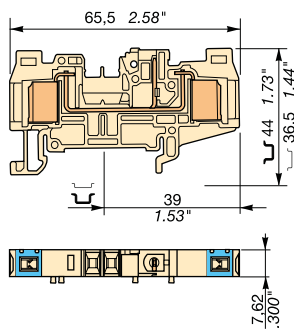

7.62 mm 0.3 in spacing

Description

- Increase your productivity with pluggable terminal blocks: possibility of pre-produced plugs harnesses, time saving plug & play assembly,
- With the TE Connectivity ADO System®, experience the fastest and most reliable connection on the market,
- Designed for rolling stock applications exposed to severe constrains (vibrations, shocks etc.),
- Up to 2 wires per connection,
- Blue marking to identify wire size.

Ordering details

Description	Color	Type	Part Numbers	Pkg qty	Weight (1 pce) g
2 ADO - 1 pluggable 1 circuit	Beige	D2.5/7.2ADO-CPE.NF	1SNA400062R0700	50	11.00

Main technical data

Connecting capacity	NF F 63-808	NF F 63-296 NF F 63-826	EN 50306
ADO Flexible without ferrule	0.93 ... 2.61 mm ²	1 ... 2.5 mm ²	
Rated current	24 A	16 A	
Rated short-time withstand current (1s)	300 A		
Rated voltage	500 V	500 V	
Impulse withstand voltage			
Protection	IP20		

Mounting instructions

Rail		TH 35-7.5, TH 35-15
Tool		ADO system tool

--	--	--	--	--	--	--	--	--	--	--	--	--	--	--	--	--	--	--	--

Compatible products

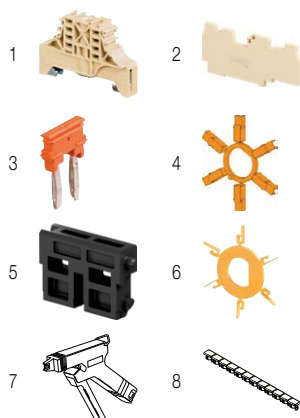

Accessories

Description	Color	Type	Part Numbers	Pkg qty	Weight (1 pce) g
1 End stops 10 mm 0.394 in	Beige	BAM2	1SNA296351R0000	50	12.00
2 End sections 2.9 mm 0.114 in	Beige	FECPE.2ADO	1SNA400018R0300	20	2.20
3 Jumper bars 10 poles 2 poles 5 poles	Orange	BJE762.10 BJE762.2 BJE762.5	1SNA290453R0500 1SNA290451R0300 1SNA290452R0400	10 10 10	24.00 5.30 15.40
4 Insulating tips For jumper bars type BJE762	Orange	EIP	1SNA290454R0600	10	100.00
5 Locking devices	Black	VRADO.CPE7	1SNA400063R0000	20	0.40
6 Coding pegs	Yellow	COCE	1SNA199321R2100	10	1.00
7 Tools Semi automatic tool Hand tool		OUPAD OUMAD	1SNA178944R0400 1SNA179466R0600	1 1	205.00 29.00
8 Terminal block markers Blank strip marker	White	RB-12W7	1SNA290455R0700	50	6.00

D4/7.ADO-CPE.NF pluggable terminal blocks

Feed-through - ADO System® - 7.62 mm 0.3 in spacing



4.32 mm²

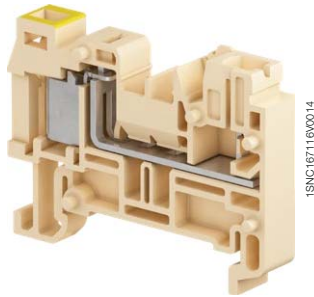

1SNC16T118X0014

D4/7.ADO-CPE.NF

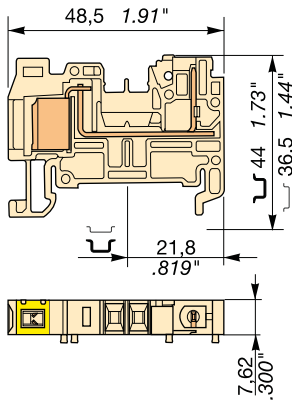

7.62 mm 0.3 in spacing

Description

- Increase your productivity with pluggable terminal blocks: possibility of pre-produced plugs harnesses, time saving plug & play assembly,
- With the TE Connectivity ADO System®, experience the fastest and most reliable connection on the market,
- Designed for rolling stock applications exposed to severe constraints (vibrations, shocks etc.),
- Up to 2 wires per connection,
- Yellow marking to identify wire size.

Ordering details

Description	Color	Type	Part Numbers	Pkg qty	Weight (1 pce)
1 ADO - 1 pluggable 1 circuit	Beige	D4/7.ADO-CPE.NF	1SNA400240R2200	50	8.40

Main technical data

Connecting capacity	NF F 63-808	NF F 63-296	EN 50306
ADO Flexible without ferrule	4.32 mm ²	NF F 63-826	
	IEC	NF F 61-017	
Rated current	24 A	16 A	
Rated short-time withstand current (1s)	480 A		
Rated voltage	500 V	500 V	
Impulse withstand voltage			
Protection	IP20		

Mounting instructions

Rail		TH 35-7.5, TH 35-15
Tool		ADO system tool

--	--	--	--	--	--	--	--	--	--	--	--	--	--	--	--	--	--	--	--

Compatible products



Accessories

Description	Color	Type	Part Numbers	Pkg qty	Weight (1 pce)
1 End stops 10 mm 0.394 in	Beige	BAM2	1SNA296351R0000	50	12.00
2 End sections 2.9 mm 0.114 in	Beige	FECPE.ADO	1SNA400019R0400	20	2.20
3 Jumper bars 10 poles 2 poles 5 poles	Orange	BJE762.10 BJE762.2 BJE762.5	1SNA290453R0500 1SNA290451R0300 1SNA290452R0400	10 10 10	24.00 5.30 15.40
4 Insulating tips For jumper bars type BJE762	Orange	EIP	1SNA290454R0600	10	100.00
5 Locking devices	Black	VRADO.CPE7	1SNA400063R0000	20	0.40
6 Coding pegs	Yellow	COCE	1SNA199321R2100	10	1.00
7 Tools Semi automatic tool Hand tool		OUPAD OUMAD	1SNA178944R0400 1SNA179466R0600	1 1	205.00 29.00
8 Terminal block markers Blank strip marker	White	RB-12W7	1SNA290455R0700	50	6.00

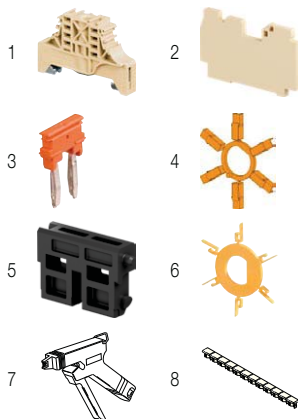

D4/7.2ADO-CPE.NF pluggable terminal blocks

Feed-through - ADO System® - 7.62 mm 0.3 in spacing



4.32 mm²

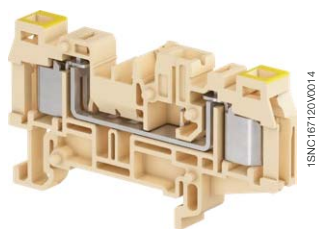

1SNC167120V0014

D4/7.2ADO-CPE.NF

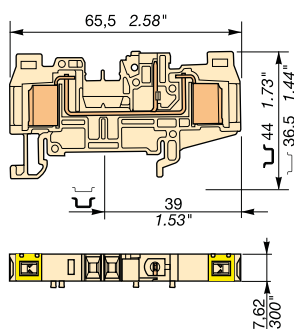

7.62 mm 0.3 in spacing

Description

- Increase your productivity with pluggable terminal blocks: possibility of pre-produced plugs harnesses, time saving plug & play assembly,
- With the TE Connectivity ADO System®, experience the fastest and most reliable connection on the market,
- Designed for rolling stock applications exposed to severe constrains (vibrations, shocks etc.),
- Up to 2 wires per connection,
- Yellow marking to identify wire size.

Ordering details

Description	Color	Type	Part Numbers	Pkg qty	Weight (1 pce) g
2 ADO - 1 pluggable 1 circuit	Beige <input type="checkbox"/>	D4/7.2ADO-CPE.NF	1SNA400241R1700	50	11.00

Main technical data

Connecting capacity	NF F 63-808	NF F 63-296 NF F 63-826	EN 50306
ADO Flexible without ferrule	4.32 mm ²		
	IEC	NF F 61-017	
Rated current	24 A	16 A	
Rated short-time withstand current (1s)	480 A		
Rated voltage	500 V	500 V	
Impulse withstand voltage			
Protection	IP20		

Mounting instructions

Rail		TH 35-7.5, TH 35-15
Tool		ADO system tool

--	--	--	--	--	--	--	--	--	--	--	--	--	--	--	--	--	--	--	--

Compatible products

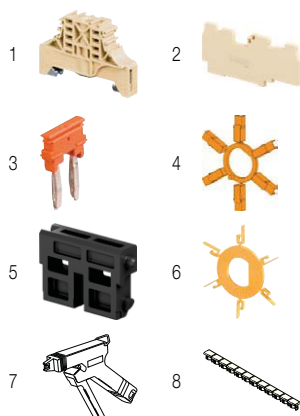

Accessories

Description	Color	Type	Part Numbers	Pkg qty	Weight (1 pce) g
1 End stops 10 mm 0.394 in	Beige <input type="checkbox"/>	BAM2	1SNA296351R0000	50	12.00
2 End sections 2.9 mm 0.114 in	Beige <input type="checkbox"/>	FECPE.2ADO	1SNA400018R0300	20	2.20
3 Jumper bars 10 poles 2 poles 5 poles	Orange <input type="checkbox"/>	BJE762.10 BJE762.2 BJE762.5	1SNA290453R0500 1SNA290451R0300 1SNA290452R0400	10 10 10	24.00 5.30 15.40
4 Insulating tips For jumper bars type BJE762	Orange <input type="checkbox"/>	EIP	1SNA290454R0600	10	100.00
5 Locking devices	Black <input type="checkbox"/>	VRADO.CPE7	1SNA400063R0000	20	0.40
6 Coding pegs	Yellow <input type="checkbox"/>	COCE	1SNA199321R2100	10	1.00
7 Tools Semi automatic tool Hand tool		OUPAD OUMAD	1SNA178944R0400 1SNA179466R0600	1 1	205.00 29.00
8 Terminal block markers Blank strip marker	White <input type="checkbox"/>	RB-12W7	1SNA290455R0700	50	6.00

1SNC167006S0201

D2.5/7.2CPE pluggable terminal blocks

Feed-through - ADO System® - 7.62 mm 0.3 in spacing

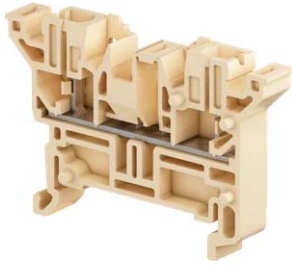

1SNC167083V0014

D2.5/7.2CPE

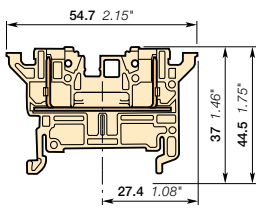

7.62 mm 0.3 in spacing

Description

- Increase your productivity with pluggable terminal blocks: possibility of pre-produced plugs harnesses, time saving plug & play assembly,
- With the TE Connectivity ADO System®, experience the fastest and most reliable connection on the market,
- Designed for rolling stock applications exposed to severe constraints (vibrations, shocks etc.),
- 1 plug on each side: 1 circuit.

Ordering details

Description	Color	Type	Part Numbers	Pkg qty	Weight (1 pce) g	
2 pluggables	1 circuit	Beige	D2.5/7.2CPE	1SNA400703R1700	50	7.00

Main technical data

Connecting capacity	NF F 63-808	NF F 63-296 NF F 63-826	EN 50306
ADO	Flexible without ferrule		

	IEC	NF F 61-017
Rated current	16 A	16 A
Rated short-time withstand current (1s)		
Rated voltage	500 V	500 V
Impulse withstand voltage		
Protection	IP20	

Mounting instructions

Rail		TH 35-7.5, TH 35-15
Tool		ADO system tool

	RoHS								
--	------	--	--	--	--	--	--	--	--

Compatible products



Accessories

Description	Color	Type	Part Numbers	Pkg qty	Weight (1 pce) g
1 End stops	Beige	BAM2	1SNA296351R0000	50	12.00
2 End sections	Beige	FECPE	1SNA400708R2400	20	1.90
3 Jumper bars	Orange	BJE762.10	1SNA290453R0500	10	24.00
		BJE762.2	1SNA290451R0300	10	5.30
		BJE762.5	1SNA290452R0400	10	15.40
4 Insulating tips	Orange	EIP	1SNA290454R0600	10	100.00
5 Locking devices	Black	VRADO.CPE7	1SNA400063R0000	20	0.40
6 Coding pegs	Yellow	COCE	1SNA199321R2100	10	1.00
7 Terminal block markers	White	RB-12W7	1SNA290455R0700	50	6.00

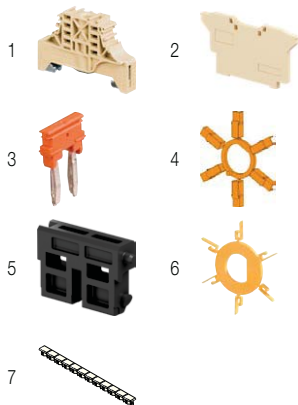

D2.5/7.CPE.CPE pluggable terminal blocks

Feed-through - ADO System® - 7.62 mm 0.3 in spacing



1SNC167121V0014

D2.5/7.CPE.CPE

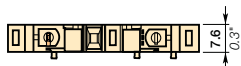
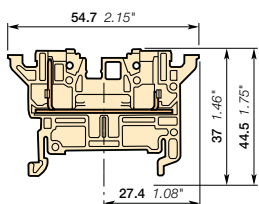

7.62 mm 0.3 in spacing

Description

- Increase your productivity with pluggable terminal blocks: possibility of pre-produced plugs harnesses, time saving plug & play assembly,
- With the TE Connectivity ADO System®, experience the fastest and most reliable connection on the market,
- Designed for rolling stock applications exposed to severe constraints (vibrations, shocks etc.),
- 1 plug on each side: 2 circuits.

Ordering details

Description	Color	Type	Part Numbers	Pkg qty	Weight (1 pce) g
2 pluggables 2 circuits	Beige	D2.5/7.CPE.CPE	1SNA400704R1000	50	7.00

Main technical data

Connecting capacity	NF F 63-808	NF F 63-296 NF F 63-826	EN 50306	Mounting instructions
ADO Flexible without ferrule				Rail TH 35-7.5, TH 35-15 Tool ADO system tool
	IEC	NF F 61-017		
Rated current	16 A	16 A		
Rated short-time withstand current (1s)				
Rated voltage	500 V	500 V		
Impulse withstand voltage				
Protection	IP20			
CE	RoHS	EAC		

Compatible products

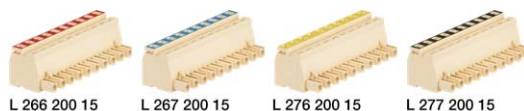

Accessories

Description	Color	Type	Part Numbers	Pkg qty	Weight (1 pce) g
1 End stops 10 mm 0.394 in	Beige	BAM2	1SNA296351R0000	50	12.00
2 End sections 2.8 mm 0.11 in	Beige	FECPE	1SNA400708R2400	20	1.90
3 Jumper bars 10 poles	Orange	BJE762.10	1SNA290453R0500	10	24.00
2 poles		BJE762.2	1SNA290451R0300	10	5.30
5 poles		BJE762.5	1SNA290452R0400	10	15.40
4 Insulating tips For jumper bars type BJE762	Orange	EIP	1SNA290454R0600	10	100.00
5 Locking devices	Black	VRADO.CPE7	1SNA400063R0000	20	0.40
6 Coding pegs	Yellow	COCE	1SNA199321R2100	10	1.00
7 Terminal block markers Blank strip marker	White	RB-12W7	1SNA290455R0700	50	6.00

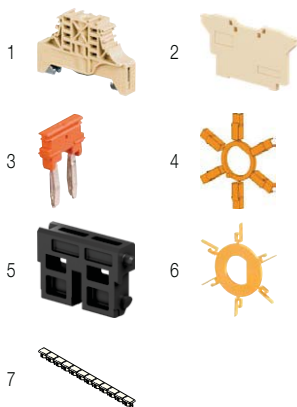

1SNC167031S0201

L 266 200 15 female plugs

ADO System® - 7.62 mm 0.3 in spacing



L 266 200 15

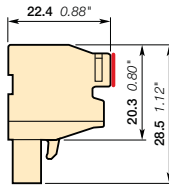
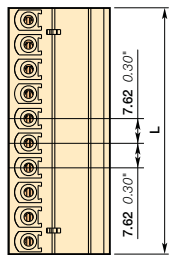

L = nb poles x 7.62
7.62 mm 0.3 in spacing

Description

- With the TE Connectivity ADO System®, experience the fastest and most reliable connection on the market,
- Designed for rolling stock applications exposed to severe constraints (vibrations, shocks etc.),
- Up to 2 wires per connection,
- Red marking to identify wire size.

Ordering details

Description	Color	Type	Part Numbers	Pkg qty	Weight (1 pce) g
Female plugs					
2 poles	Beige	FIC F.ADO.T1.2P.NF	1SSS266202R8800	50	6.00
3 poles	Beige	FIC F.ADO.T1.3P.NF	1SSS266203R8800	50	10.00
4 poles	Beige	FIC F.ADO.T1.4P.NF	1SSS266204R8800	50	13.00
5 poles	Beige	FIC F.ADO.T1.5P.NF	1SSS266205R8800	50	16.00
6 poles	Beige	FIC F.ADO.T1.6P.NF	1SSS266206R8800	50	19.00
7 poles	Beige	FIC F.ADO.T1.7P.NF	1SSS266207R8800	50	22.00
8 poles	Beige	FIC F.ADO.T1.8P.NF	1SSS266208R8800	50	26.00
9 poles	Beige	FIC F.ADO.T1.9P.NF	1SSS266209R8800	50	29.00
10 poles	Beige	FIC F.ADO.T1.10P.NF	1SSS266210R8800	50	32.00

Main technical data

Connecting capacity	NF F 63-808	NF F 63-296 NF F 63-826	EN 50306
ADO Flexible without ferrule	0.6 ... 1.82 mm²		0.5 ... 1.5 mm²
Rated current	16 A	16 A	
Rated short-time withstand current (1s)	218.4 A		
Rated voltage	500 V	500 V	
Impulse withstand voltage			
Protection	IP20		

Mounting instructions

Rail			
Tool			ADO system tool

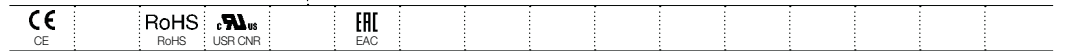

Compatible products



Accessories

Description	Color	Type	Part Numbers	Pkg qty	Weight (1 pce) g
1 Cable clamps	Beige	PT1	1SSS299253R2800	20	1.60
		PT2	1SSS299254R2800	20	4.80
2 Coding pegs	Yellow	COCF	1SNA199320R0400	10	1.00
3 Tools		OUPAD	1SNA178944R0400	1	205.00
		OUMAD	1SNA179466R0600	1	29.00
4 Terminal block markers	White	RB-12W7	1SNA290455R0700	50	6.00

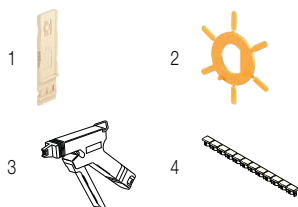

L 266 200 25 female plugs with brackets

ADO System® - 7.62 mm 0.3 in spacing



L 266 200 25

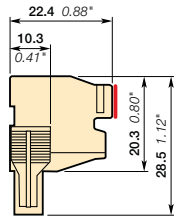
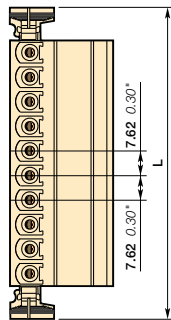

$L = (nb \text{ poles} \times 7.62) + 13.7$

7.62 mm 0.3 in spacing

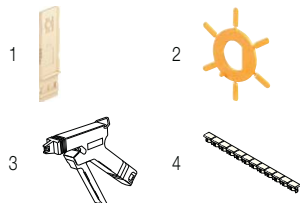

Description

- With the TE Connectivity ADO System®, experience the fastest and most reliable connection on the market,
- Designed for rolling stock applications exposed to severe constraints (vibrations, shocks etc.),
- Up to 2 wires per connection,
- Red marking to identify wire size.

Ordering details

Description	Color	Type	Part Numbers	Pkg qty	Weight (1 pce)
Female plugs	2 poles	Beige <input type="checkbox"/> FIC F.ADO.T1.B.2P.NF	1SSS266202R9800	50	7.40
	3 poles	Beige <input type="checkbox"/> FIC F.ADO.T1.B.3P.NF	1SSS266203R9800	50	10.00
	4 poles	Beige <input type="checkbox"/> FIC F.ADO.T1.B.4P.NF	1SSS266204R9800	50	14.00
	5 poles	Beige <input type="checkbox"/> FIC F.ADO.T1.B.5P.NF	1SSS266205R9800	50	18.00
	6 poles	Beige <input type="checkbox"/> FIC F.ADO.T1.B.6P.NF	1SSS266206R9800	50	21.00
	8 poles	Beige <input type="checkbox"/> FIC F.ADO.T1.B.8P.NF	1SSS266208R9800	50	28.00
10 poles	Beige <input type="checkbox"/> FIC F.ADO.T1.B.10P.NF	1SSS266210R9800	50	35.00	

Main technical data

Connecting capacity	NF F 63-808	NF F 63-296 NF F 63-826	EN 50306
ADO Flexible without ferrule	0.6 ... 1.82 mm²	0.5 ... 1.5 mm²	
Rated current	16 A	16 A	
Rated short-time withstand current (1s)	218.4 A		
Rated voltage	500 V	500 V	
Impulse withstand voltage			
Protection	IP20		

Mounting instructions

Rail		
Tool		ADO system tool

CE	RoHS	UL	EAC						
CE	RoHS	UL	EAC						

Compatible products

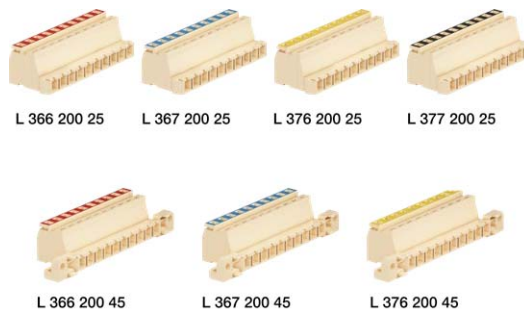

Accessories

Description	Color	Type	Part Numbers	Pkg qty	Weight (1 pce)
1 Cable clamps	Beige <input type="checkbox"/>	PT1	1SSS299253R2800	20	1.60
		PT2	1SSS299254R2800	20	4.80
2 Coding pegs	Yellow <input type="checkbox"/>	COCF	1SNA199320R0400	10	1.00
3 Tools		OUPAD	1SNA178944R0400	1	205.00
		OUMAD	1SNA179466R0600	1	29.00
4 Terminal block markers	White <input type="checkbox"/>	RB-12W7	1SNA290455R0700	50	6.00

L 277 200 15 female plugs

ADO System® - 7.62 mm 0.3 in spacing



L 277 200 15

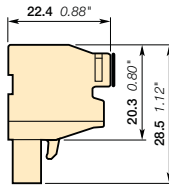
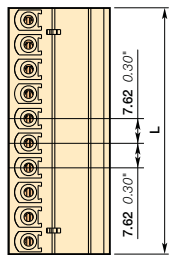

L = nb poles x 7.62
7.62 mm 0.3 in spacing

Description

- With the TE Connectivity ADO System®, experience the fastest and most reliable connection on the market,
- Designed for rolling stock applications exposed to severe constraints (vibrations, shocks etc.),
- Up to 2 wires per connection,
- Black marking to identify wire size.

Ordering details

Description	Color	Type	Part Numbers	Pkg qty	Weight (1 pce) g
Female plugs					
2 poles	Beige	FIC F.ADO.T3-.2P.NF	1SSS277202R8800	50	6.00
3 poles	Beige	FIC F.ADO.T3-.3P.NF	1SSS277203R8800	50	10.00
4 poles	Beige	FIC F.ADO.T3-.4P.NF	1SSS277204R8800	50	13.00
5 poles	Beige	FIC F.ADO.T3-.5P.NF	1SSS277205R8800	50	16.00
6 poles	Beige	FIC F.ADO.T3-.6P.NF	1SSS277206R8800	50	19.00

Main technical data

Connecting capacity	NF F 63-808	NF F 63-296 NF F 63-826	EN 50306
ADO	Flexible without ferrule	1.5 mm²	
Rated current	24 A	16 A	
Rated short-time withstand current (1s)	180 A		
Rated voltage	500 V	500 V	
Impulse withstand voltage			
Protection	IP20		

Mounting instructions

Rail		
Tool		ADO system tool

CE	RoHS	EAC							
----	------	-----	--	--	--	--	--	--	--

Compatible products



Accessories

Description	Color	Type	Part Numbers	Pkg qty	Weight (1 pce) g
1 Cable clamps	Beige	PT1	1SSS299253R2800	20	1.60
		PT2	1SSS299254R2800	20	4.80
2 Coding pegs	Yellow	COCF	1SNA199320R0400	10	1.00
3 Tools		OUPAD	1SNA178944R0400	1	205.00
		OUMAD	1SNA179466R0600	1	29.00
4 Terminal block markers	White	RB-12W7	1SNA290455R0700	50	6.00

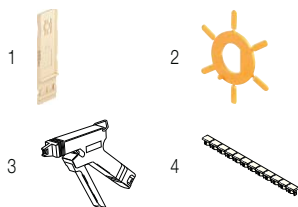

L 267 200 15 female plugs

ADO System® - 7.62 mm 0.3 in spacing



2.61 mm²



L 267 200 15

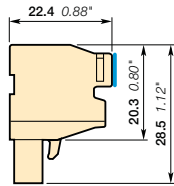
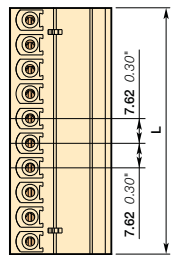

L = nb poles x 7.62

7.62 mm 0.3 in spacing

Description

- With the TE Connectivity ADO System®, experience the fastest and most reliable connection on the market,
- Designed for rolling stock applications exposed to severe constraints (vibrations, shocks etc.),
- Up to 2 wires per connection,
- Blue marking to identify wire size.

Ordering details

Description	Color	Type	Part Numbers	Pkg qty	Weight (1 pce) g
Female plugs	Beige	FIC F.ADO.T2.2P.NF	1SSS267202R8800	50	6.00
	Beige	FIC F.ADO.T2.3P.NF	1SSS267203R8800	50	10.00
	Beige	FIC F.ADO.T2.4P.NF	1SSS267204R8800	50	13.00
	Beige	FIC F.ADO.T2.5P.NF	1SSS267205R8800	50	16.00
	Beige	FIC F.ADO.T2.6P.NF	1SSS267206R8800	50	19.00
	Beige	FIC F.ADO.T2.7P.NF	1SSS267207R8800	50	22.00
	Beige	FIC F.ADO.T2.8P.NF	1SSS267208R8800	50	26.00
	Beige	FIC F.ADO.T2.10P.NF	1SSS267210R8800	50	32.00

Main technical data

Connecting capacity	NF F 63-808	NF F 63-296 NF F 63-826	EN 50306
ADO Flexible without ferrule	0.93 ... 2.61 mm ²	1 ... 2.5 mm ²	
Rated current	24 A	16 A	
Rated short-time withstand current (1s)	313.2 A		
Rated voltage	500 V	500 V	
Impulse withstand voltage			
Protection	IP20		

Mounting instructions

Tool	ADO system tool

CE	RoHS	USR CNR	EAC
----	------	---------	-----

Compatible products



Accessories

Description	Color	Type	Part Numbers	Pkg qty	Weight (1 pce) g
1 Cable clamps Used on products from 3 to 7 poles Used on products from 8 to 16 poles	Beige	PT1	1SSS299253R2800	20	1.60
		PT2	1SSS299254R2800	20	4.80
2 Coding pegs	Yellow	COCF	1SNA199320R0400	10	1.00
3 Tools Semi automatic tool Hand tool		OUPAD	1SNA178944R0400	1	205.00
		OUMAD	1SNA179466R0600	1	29.00
4 Terminal block markers Blank strip marker	White	RB-12W7	1SNA290455R0700	50	6.00

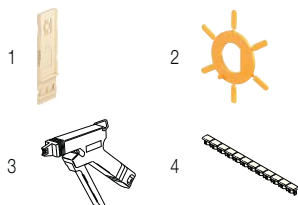

L 267 200 25 female plugs with brackets

ADO System® - 7.62 mm 0.3 in spacing



L 267 200 25

1SNC167125V0014

Description

- With the TE Connectivity ADO System®, experience the fastest and most reliable connection on the market,
- Designed for rolling stock applications exposed to severe constraints (vibrations, shocks etc.),
- Up to 2 wires per connection,
- Blue marking to identify wire size.

Ordering details

Description	Color	Type	Part Numbers	Pkg qty	Weight (1 pce) g
Female plugs					
2 poles	Beige	FIC F.ADO.T2.B.2PNF	1SSS267202R9800	50	7.40
3 poles	Beige	FIC F.ADO.T2.B.3PNF	1SSS267203R9800	50	11.00
4 poles	Beige	FIC F.ADO.T2.B.4PNF	1SSS267204R9800	50	14.00
5 poles	Beige	FIC F.ADO.T2.B.5PNF	1SSS267205R9800	50	18.00
6 poles	Beige	FIC F.ADO.T2.B.6PNF	1SSS267206R9800	50	21.00
8 poles	Beige	FIC F.ADO.T2.B.8PNF	1SSS267208R9800	50	28.00
10 poles	Beige	FIC F.ADO.T2.B.10PNF	1SSS267210R9800	50	35.00
16 poles	Beige	FIC F.ADO.T2.B.16PNF	1SSS267216R9800	20	57.00

Main technical data

Connecting capacity	NF F 63-808	NF F 63-296 NF F 63-826	EN 50306
ADO Flexible without ferrule	0.93 ... 2.61 mm²		1 ... 2.5 mm²
Rated current	24 A	16 A	
Rated short-time withstand current (1s)	313.2 A		
Rated voltage	500 V	500 V	
Impulse withstand voltage			
Protection	IP20		

Mounting instructions

Rail		
Tool		ADO system tool

CE	RoHS	UL	ERC																
CE	RoHS	UL	ERC																

Compatible products

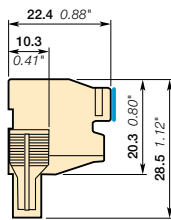
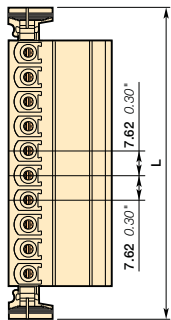

$L = (\text{nb poles} \times 7.62) + 13.7$

7.62 mm 0.3 in spacing

Accessories

Description	Color	Type	Part Numbers	Pkg qty	Weight (1 pce) g
1 Cable clamps	Beige	PT1	1SSS299253R2800	20	1.60
		PT2	1SSS299254R2800	20	4.80
2 Coding pegs	Yellow	COCF	1SNA199320R0400	10	1.00
3 Tools		OUPAD	1SNA178944R0400	1	205.00
		OUMAD	1SNA179466R0600	1	29.00
4 Terminal block markers	White	RB-12W7	1SNA290455R0700	50	6.00

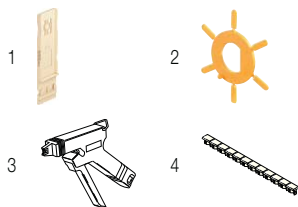

L 276 200 15 female plugs

ADO System® - 7.62 mm 0.3 in spacing



4.32 mm²

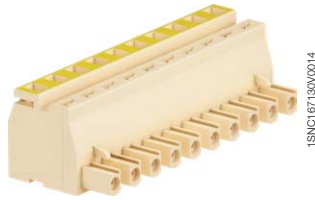

1SNC167190V0014

L 276 200 15

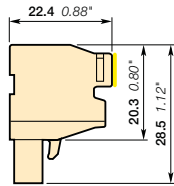
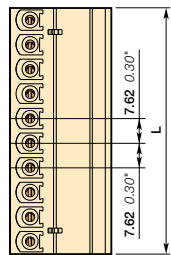

L = nb poles x 7.62

7.62 mm 0.3 in spacing

Description

- With the TE Connectivity ADO System®, experience the fastest and most reliable connection on the market,
- Designed for rolling stock applications exposed to severe constraints (vibrations, shocks etc.),
- Up to 2 wires per connection,
- Yellow marking to identify wire size.

Ordering details

Description	Color	Type	Part Numbers	Pkg qty	Weight (1 pce) g
Female plugs	Beige	FIC F.ADO.T3.4P.NF	1SSS276204R8800	50	13.00
	Beige	FIC F.ADO.T3.5P.NF	1SSS276205R8800	50	16.00

Main technical data

Connecting capacity	NF F 63-808	NF F 63-296 NF F 63-826	EN 50306	Mounting instructions
ADO Flexible without ferrule	4.32 mm ²			Rail Tool  ADO system tool
Rated current	24 A	16 A		
Rated short-time withstand current (1s)	518.4 A			
Rated voltage	500 V	500 V		
Impulse withstand voltage				
Protection	IP20			

Compatible products

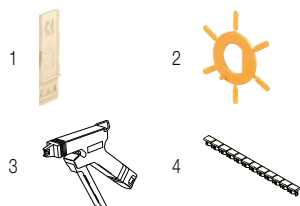

Accessories

Description	Color	Type	Part Numbers	Pkg qty	Weight (1 pce) g
1 Cable clamps	Beige	PT1	1SSS299253R2800	20	1.60
		PT2	1SSS299254R2800	20	4.80
2 Coding pegs	Yellow	COCF	1SNA199320R0400	10	1.00
3 Tools		OUPAD	1SNA178944R0400	1	205.00
		OUMAD	1SNA179466R0600	1	29.00
4 Terminal block markers	White	RB-12W7	1SNA290455R0700	50	6.00

1SNC16701450201

L 366 200 45 male plugs with flanges and inserts

ADO System® - 7.62 mm 0.3 in spacing



1.82 mm²



15NC167131W0014

L 366 200 45

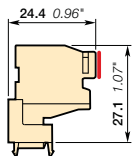
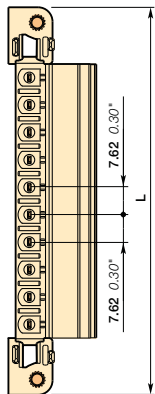

$L = (\text{nb poles} \times 7.62) + 31.5$

7.62 mm 0.3 in spacing

Description

- With the TE Connectivity ADO System®, experience the fastest and most reliable connection on the market,
- Designed for rolling stock applications exposed to severe constraints (vibrations, shocks etc.),
- Up to 2 wires per connection,
- Red marking to identify wire size.

Ordering details

Description	Color	Type	Part Numbers	Pkg qty	Weight (1 pce) g
Male plugs	Beige	FIC M.ADO.T1.FI.2P.NF	1SSS366202R4100	50	
	Beige	FIC M.ADO.T1.FI.3P.NF	1SSS366203R4100	50	
	Beige	FIC M.ADO.T1.FI.4P.NF	1SSS366204R4100	50	
	Beige	FIC M.ADO.T1.FI.5P.NF	1SSS366205R4100	50	
	Beige	FIC M.ADO.T1.FI.6P.NF	1SSS366206R4100	50	
	Beige	FIC M.ADO.T1.FI.8P.NF	1SSS366208R4100	50	
	Beige	FIC M.ADO.T1.FI.10P.NF	1SSS366210R4100	50	

Main technical data

Connecting capacity	NF F 63-808	NF F 63-296 NF F 63-826	EN 50306
ADO Flexible without ferrule	0.6 ... 1.82 mm²		0.5 ... 1.5 mm²
Rated current	IEC 16 A	NF F 61-017 16 A	
Rated short-time withstand current (1s)	218.4 A		
Rated voltage	500 V	500 V	
Impulse withstand voltage			
Protection	IP20		

Mounting instructions

Mounting instructions	Tool	ADO system tool
Rail		
Tool		ADO system tool



Compatible products



L 266 200 25



L 267 200 25



L 276 200 25

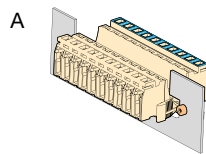

A: Panel feed-through or base mounting

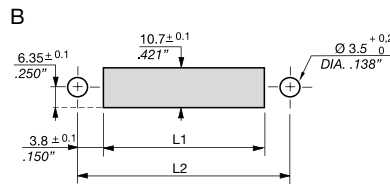

B: Panel feed-through drilling
 $L1 = (\text{nb poles} \times 7.62) + 15.24$
 $L2 = (\text{nb poles} \times 7.62) + 22.86$

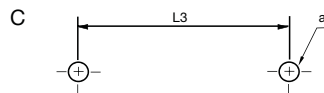

C: Base drilling
 $L3 = (\text{nb poles} \times 7.62) + 22.86$
 a: M2.5 or M3 insert on panel

Accessories

Description	Color	Type	Part Numbers	Pkg qty	Weight (1 pce) g
1 Cable clamps	Beige	PT1	1SSS299253R2800	20	1.60
		PT2	1SSS299254R2800	20	4.80
2 Tools		OUPAD	1SNA178944R0400	1	205.00
		OUMAD	1SNA179466R0600	1	29.00
3 Terminal block markers	White	RB-12W7	1SNA290455R0700	50	6.00

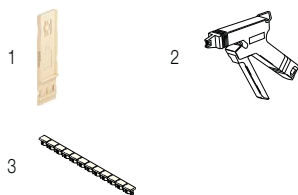

L 367 200 45 male plugs with flanges and inserts

ADO System® - 7.62 mm 0.3 in spacing



2.61 mm²



L 367 200 45

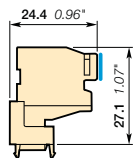
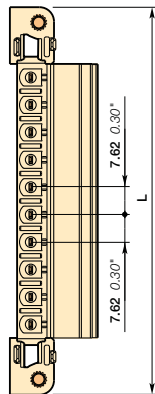

$L = (\text{nb poles} \times 7.62) + 31.5$

7.62 mm 0.3 in spacing

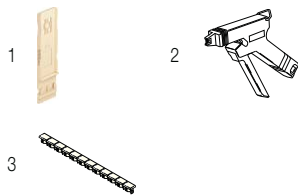

Description

- With the TE Connectivity ADO System®, experience the fastest and most reliable connection on the market,
- Designed for rolling stock applications exposed to severe constraints (vibrations, shocks etc.),
- Up to 2 wires per connection,
- Blue marking to identify wire size.

Ordering details

Description	Color	Type	Part Numbers	Pkg qty	Weight (1 pce) g
Male plugs	2 poles	Beige □ FIC M.ADO.T2.FI.2P.NF	1SSS367202R4100	50	
	3 poles	Beige □ FIC M.ADO.T2.FI.3P.NF	1SSS367203R4100	50	
	4 poles	Beige □ FIC M.ADO.T2.FI.4P.NF	1SSS367204R4100	50	
	5 poles	Beige □ FIC M.ADO.T2.FI.5P.NF	1SSS367205R4100	50	
	6 poles	Beige □ FIC M.ADO.T2.FI.6P.NF	1SSS367206R4100	50	
	8 poles	Beige □ FIC M.ADO.T2.FI.8P.NF	1SSS367208R4100	50	
	10 poles	Beige □ FIC M.ADO.T2.FI.10P.NF	1SSS367210R4100	50	

Main technical data

Connecting capacity	NF F 63-808	NF F 63-296 NF F 63-826	EN 50306
ADO Flexible without ferrule	0.93 ... 2.61 mm ²		1 ... 2.5 mm ²
Rated current	IEC 22 A	NF F 61-017 16 A	
Rated short-time withstand current (1s)	313.2 A		
Rated voltage	500 V	500 V	
Impulse withstand voltage			
Protection	IP20		

Mounting instructions

Rail		
Tool		ADO system tool



Compatible products



L 266 200 25



L 267 200 25



L 276 200 25

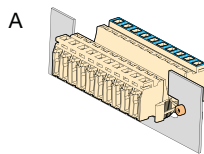

A: Panel feed-through or base mounting

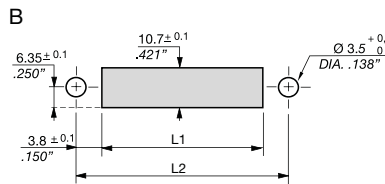

B: Panel feed-through drilling
 $L1 = (\text{nb poles} \times 7.62) + 15.24$
 $L2 = (\text{nb poles} \times 7.62) + 22.86$

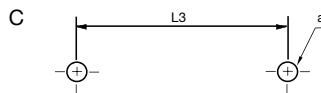

C: Base drilling
 $L3 = (\text{nb poles} \times 7.62) + 22.86$
 a: M2.5 or M3 insert on panel

Accessories

Description	Color	Type	Part Numbers	Pkg qty	Weight (1 pce) g
1 Cable clamps	Beige □	Used on products from 3 to 7 poles	PT1	1SSS299253R2800	20 1.60
		Used on products from 8 to 16 poles	PT2	1SSS299254R2800	20 4.80
2 Tools		Semi automatic tool	OUPAD	1SNA178944R0400	1 205.00
		Hand tool	OUMAD	1SNA179466R0600	1 29.00
3 Terminal block markers	White □	Blank strip marker	RB-12W7	1SNA290455R0700	50 6.00

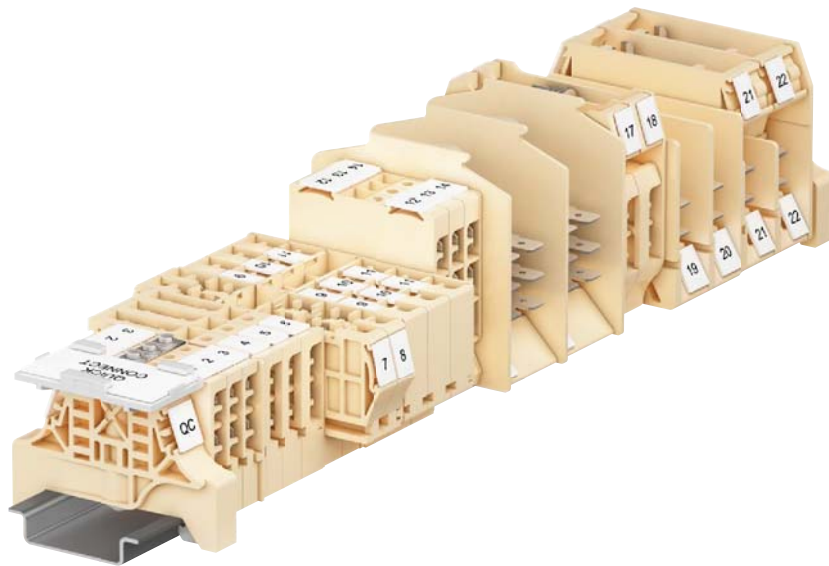

Railway applications, terminal blocks

Quick-connect technology



Technologies presentation		138
Overview		140
With longitudinal quick-connect tabs		
2.5 mm ²	HD2.5/6.2G.2G.1	2 longitudinal tabs on each side 144
6 mm ²	HD6/8.2G.2G.1	2 longitudinal tabs on each side 145
	HD6/8.2G.2G.2	2 longitudinal tabs and 2 vertical tabs 146
	HD6/7.5G	5 vertical tabs 147
	HD6/7.3G.2G	2 circuits-3 vertical tabs with jumper and 2 vertical tabs 148
	HD6/7.2G.3G	2 circuits-3 vertical tabs and 2 vertical tabs with jumper 149
	HD6/9.5G	5 vertical tabs 150
	HD6/9.3G.2G	2 circuits-3 vertical tabs with jumper and 2 vertical tabs 151
	HD6/9.2G.3G	2 circuits-3 vertical tabs and 2 vertical tabs with jumper 152
Stud-quick-connect		
35 mm ²	HD6/22.F12G	1 M6 stud - 12 quick-connect tabs 153
	HD6/30.F12G	1 M6 stud - 12 quick-connect tabs 154
Fuse holder		
6 mm ²	HD6/14.SF.2G.2G	for 5x20mm fuses 155
Component holder		
6 mm ²	HD6/24.DH	For screw and solder diode-6 tabs 156
	HD6/24.DH	For screw and solder diode-8 tabs 156
	HD6/14.DH	For screw and solder diode-2 tabs on each side 157
	HD6/14.DG	For solder diode or resistor-2 tabs on each side 158
	HD6/9.SDH.1	Disconnect with component holder plug 159
	HD6/14.SDH.1	Disconnect with component holder plug for screw & solder diode 160
	HD6/14.SDH	Disconnect with component holder plug for screw & solder diode type SKN2.5 or SKNa2 161
Multi level longitudinal quick-connect tabs		
2.5 mm ²	HD2.5/6.3.3G.3G.1	1 circuit - 6 tabs 162
	HD2.5/6.3.2G.2G.1.GG	Top circuit with 4 tabs - Bottom circuit with 2 tabs 163
	HD2.5/6.3.GG1.2G.2G	Top circuit with 2 tabs - Bottom circuit with 4 tabs 164
	HD2.5/6.3.GG.1.2GG	3 circuits - 1 tab each side 165
	HD2.5/6.3.2G.2G.1	1 Top circuit with 4 tabs 166
	HD2.5/6.3.GH.2G.H	1 top circuit with 1 tab & 1 solder connection - 1 bottom circuit with 2 tabs & 1 solder connection 167

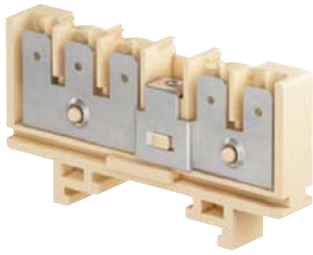

The historical technology for railway control and signal distribution

The Quick-connect technology allows to save wiring time and is a good solution for distribution of control signal. It can be used in case of limited space on the side (vertical version), when a high density connection is needed (horizontal version up to 6 connection per block) or when the power has to be distributed from power to control circuits (1 stud input / 12 quick-connect outputs).



Reliable in harsh conditions

Continuous operation guaranteed for rolling stock

- Environmental tests: aging, corrosion, flammability, toxicity (I2F2, V0, HL3 R22)
- Mechanical tests: vibration and shock.



Improve installation efficiency

Large and flexible offering

- Top or side connection
- Up to 6 connections in 1 block
- Easy distribution thanks to hybrid versions with both fast-on and stud connections
- Circuit protection thanks to component holder.

Features

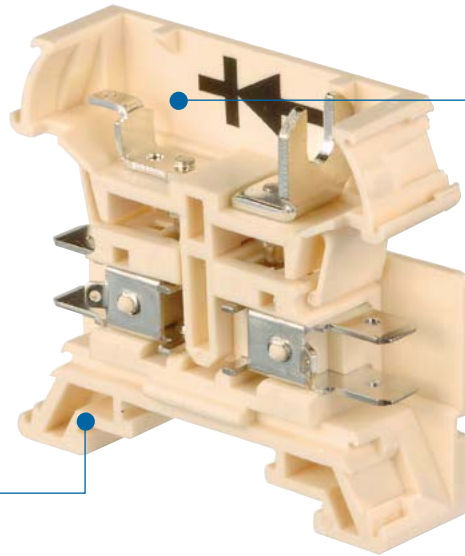

Area dedicated to component soldering and screwing (SKN diodes or resistors)

Compatible with both CCTU and DIN3 rails

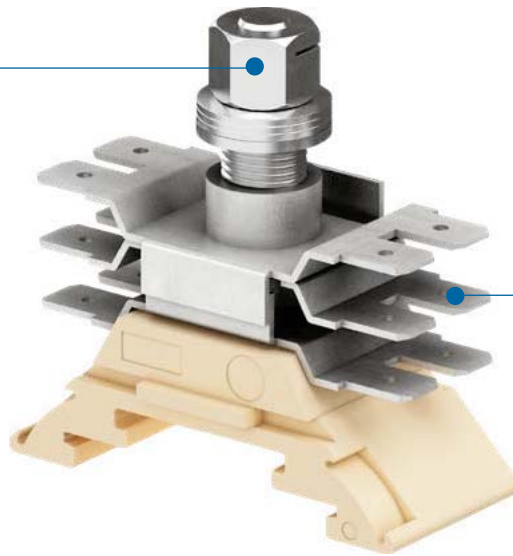

High density power distribution (35 mm² / 155 A)

Control circuits (2.5 mm² / 16 A)

Railway applications, terminal blocks

Quick-connect technology

Range overview from 2.5 up to 6 mm²

Feed-through
From 2.5 to 6 mm²

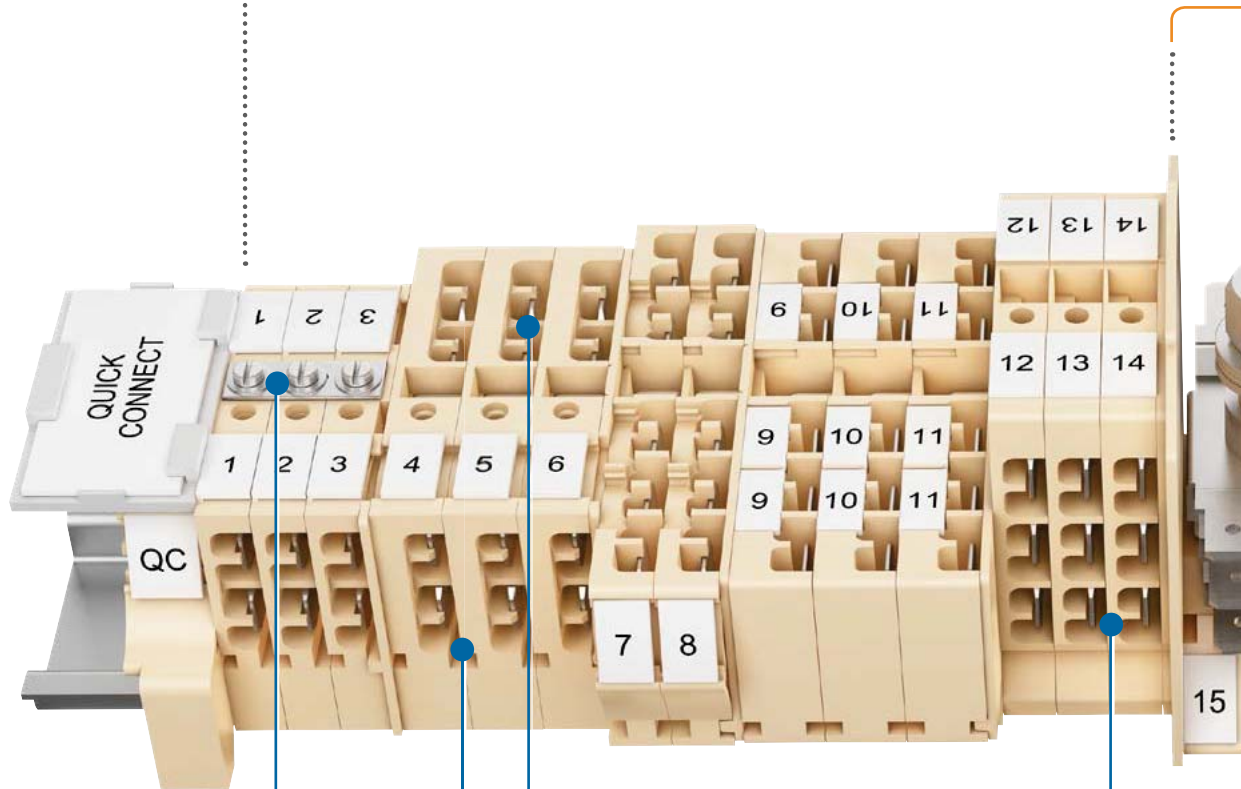

Perforated jumpering bars
Easy to install by cutting out the precut partitions

Top or side connection
Flexibility of the connection angle

High connection density
Up to 6 connections in 6 mm spacing

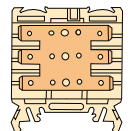
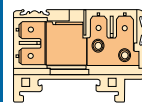

Distribution

35 mm² / 2.5 mm²

Component holder

From 2.5 to 6 mm²

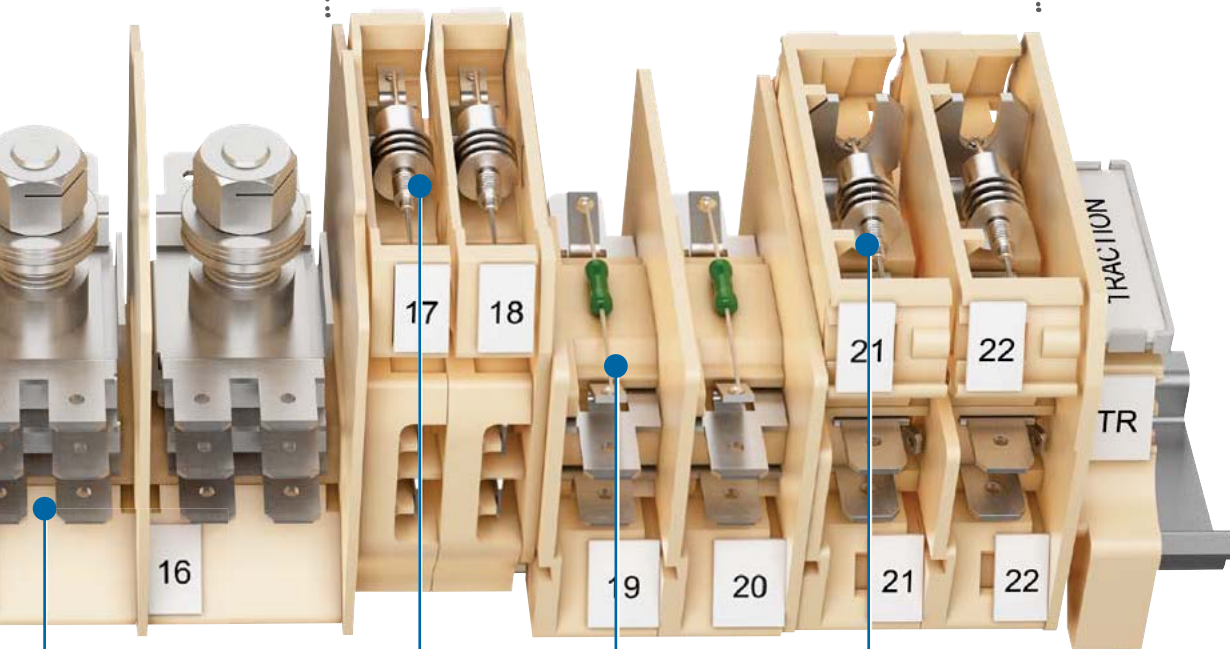

**Easy distribution
of up to 12 outputs**

With quick-connect / stud
hybrid terminal blocks



Component holders

Easy to solder diodes or resistors
for circuit protection

Railway applications, terminal blocks

Quick-connect technology

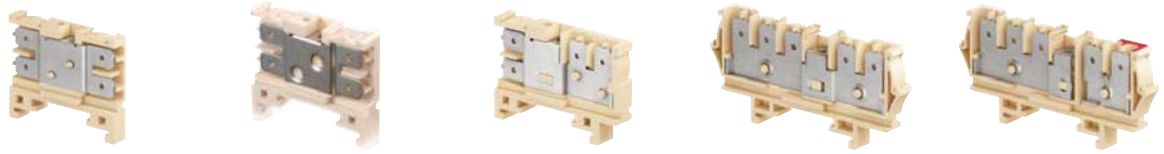
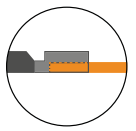

Feed-through

7 mm spacing

Section					
2.5 mm ²	HD2.5/6.2G.2G.1	HD6/8.2G.2G.1	HD6/8.2G.2G.2	HD6/7.5G	HD6/7.3G.2G
6 mm ²					



Stud-quick-connect

Fuse holder

Section				
6 mm ²			HD6/14.SF2G.2G	HD6/24.DH
35 mm ² / 2.5 mm ²	HD6/22.F12G			
35 mm ² / 6 mm ²		HD6/30.F12G		

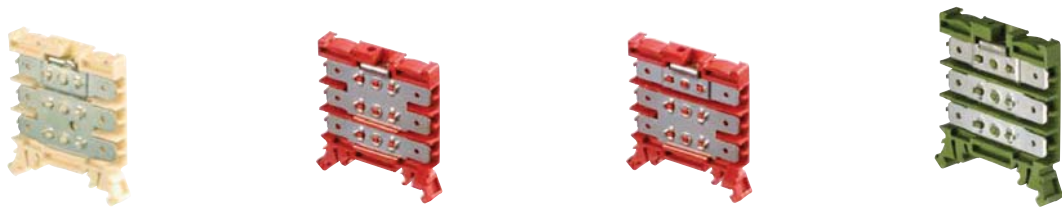

Multi level longitudinal quick-connect tabs-Feed-through

Section				
2.5 mm ²	HD2.5/6.3.3G.3G.1	HD2.5/6.3.2G.2G.1.GG	HD2.5/6.3.GG1.2G.2G	HD2.5/6.3.GG.1.2GG

Clamp -
 Channels for jumpering or testing -
 Test socket -
 Blown-fuse indicator

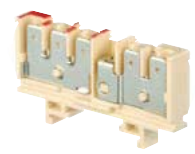
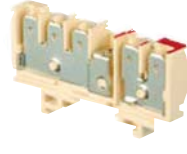
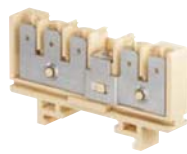
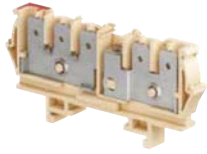
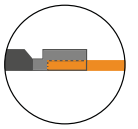

9 mm spacing



HD6/7.2G.3G



HD6/9.5G



HD6/9.3G.2G



HD6/9.2G.3G

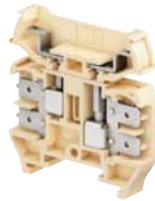
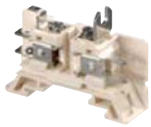

Component holder



HD6/14.DH



HD6/14.DG



HD6/9.SDH.1



HD6/14.SDH.1



HD6/14.SDH



HD2.5/6.3.2G.2G.1



HD2.5/6.3.GH.2G.H

HD2.5/6.2G.2G.1 Quick connect terminal blocks

Feed-through - 6 mm 0.236 in spacing

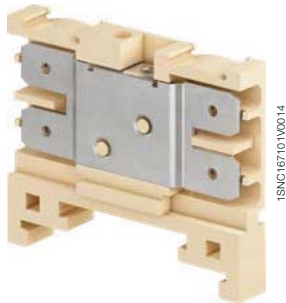

HD2.5/6.2G.2G.1

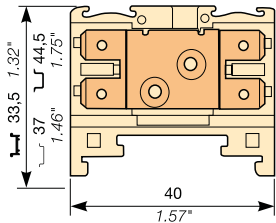

6 mm 0.236 in spacing

Description

- Connection by 2 longitudinal tabs for quick-connect 6.3 x 0.8 mm 0.248 x 0.031 in on each side,
- Possibility of testing,
- Two jumpering options: 6 mm 0.236 in spacing with BJS61 and 7 mm 0.276 in (adding end section) with BJH7,
- Use of jumper bars requires to cut out the precut partition,
- NF F 61-017 designation: BB0006-2G2G (1SNA160487R2500) or BB0007-2G2G (1SNA160487R2500 + FEH3).

Ordering details

Description	Color	Type	Part Numbers	Pkg qty	Weight (1 pce) g
4 tabs 1 circuit	Beige	HD2.5/6.2G.2G.1	1SNA160487R2500	50	7.00

Main technical data

Connecting capacity	NF C	DIN	NF F 61-017	Mounting instructions
1 conductor per clamp Quick-connect: 6.3 x 0.8 mm	0.34 ... 2.5 mm ²			Rail Type 2, TH 35-7.5, TH 35-15
Rated voltage V AC	(Cat. C) 250 V	(Cat. C) 125 V	250 V	
V DC	(Cat. C) 250 V	(Cat. C) 150 V	250 V	
Rated current	25 A	26 A	20 A	
Rated cross section	2.5 mm ²	2.5 mm ²		

--	--	--	--	--	--	--	--	--	--

Accessories

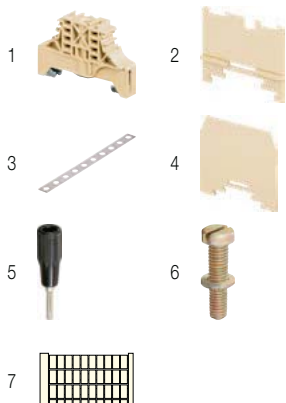

Description	Color	Type	Part Numbers	Pkg qty	Weight (1 pce) g
1 End stops 10 mm 0.394 in	Beige	BAM2	1SNA296351R0000	50	12.00
10.7 mm 0.421 in		BAH24	1SNA168355R1300	50	12.00
2 End sections 1 mm 0.039 in	Beige	FEH3	1SNA198352R0700	20	1.10
3 Jumper bars 2 poles 32 A (IEC)		BJS61-2	1SNA168481R2300	10	1.80
3 poles 32 A (IEC)		BJS61-3	1SNA168482R2400	10	1.80
4 poles 32 A (IEC)		BJS61-4	1SNA168483R2500	10	1.80
5 poles 32 A (IEC)		BJS61-5	1SNA168484R2600	10	1.80
10 poles 32 A (IEC)		BJS61-10	1SNA168485R2700	10	2.00
2 poles		BJH7-2	1SNA168486R2000	10	0.50
3 poles		BJH7-3	1SNA168487R2100	10	0.80
10 poles		BJH7-10	1SNA168490R0000	10	3.00
4 Circuit separators 1.6 mm 0.063 in	Beige	SCH3	1SNA198692R2500	10	4.30
5 Test plugs DIA 2 mm 0.079 in	Black	FC2	1SNA007865R2600	100	2.00
6 Fastening kits Screw M2.5x5 for jumper bar BJH		VSJ6	1SNA167735R2700	1	
Washer for screw VSJ		RDJ6	1SNA173241R0600	1000	0.10
7 Terminal block markers Blank card	White	RC610	1SNA233000R0100	10	7.50

HD6/8.2G.2G.1 Quick connect terminal blocks

Feed-through - 8 mm 0.315 in spacing



6 mm²

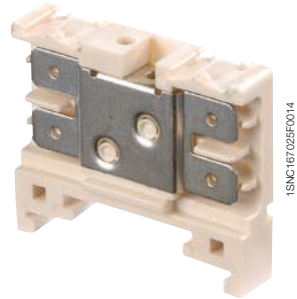

1SNC167025F0014

HD6/8.2G.2G.1

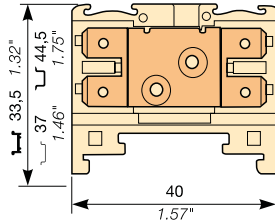

8 mm 0.315 in spacing

Description

- Connection by 2 longitudinal tabs for quick-connect 6.3 x 0.8 mm 0.248 x .031 in on each side,
- Possibility of testing,
- Two jumpering options: 8 mm 0.315 in spacing with BJH8 and 9 mm 0.354 in spacing (adding end section) with BJH9,
- Use of jumper bars requires to cut out the precut partition,
- NF F 61-017 designation: BB0008-2G2G (1SNA160606R1400) or BB0009-2G2G (1SNA160606R1400 + FEH3).

Ordering details

Description	Color	Type	Part Numbers	Pkg qty	Weight (1 pce) g
4 tabs 1 circuit	Beige <input type="checkbox"/>	HD6/8.2G.2G.1	1SNA160606R1400	50	8.00

Main technical data

Connecting capacity	NF C	DIN	NF F 61-017	Mounting instructions
1 conductor per clamp	Quick-connect: 6.3 x 0.8 mm	0.34 ... 6 mm ²		Rail Type 2, TH 35-7.5, TH 35-15
Rated voltage	V AC	(Cat. C) 250 V	(Cat. C) 250 V	250 V
	V DC	(Cat. C) 250 V	(Cat. C) 300 V	250 V
Rated current		25 A	26 A	20 A
Rated cross section		6 mm ²	6 mm ²	

--	--	--	--	--	--	--	--	--	--

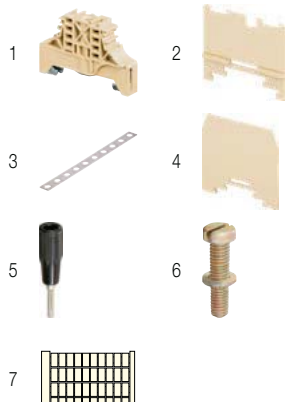

Accessories

Description	Color	Type	Part Numbers	Pkg qty	Weight (1 pce) g	
1 End stops	Beige <input type="checkbox"/>	BAM2	1SNA296351R0000	50	12.00	
		BAH24	1SNA168355R1300	50	12.00	
2 End sections	Beige <input type="checkbox"/>	FEH3	1SNA198352R0700	20	1.10	
3 Jumper bars		2 poles	BJH8-2	1SNA168456R0100	10	0.60
		3 poles	BJH8-3	1SNA168457R0200	10	0.90
		4 poles	BJH8-4	1SNA168458R1300	10	1.30
		5 poles	BJH8-5	1SNA168459R1400	10	1.60
		10 poles	BJH8-10	1SNA168356R1400	10	3.40
		2 poles	BJH9-2	1SNA168460R1100	10	1.60
		3 poles	BJH9-3	1SNA168461R0600	10	1.00
		4 poles	BJH9-4	1SNA168462R0700	10	1.40
		5 poles	BJH9-5	1SNA168463R0000	10	1.80
		10 poles	BJH9-10	1SNA168357R1500	10	3.80
4 Circuit separators	Beige <input type="checkbox"/>	SCH3	1SNA198692R2500	10	4.30	
5 Test plugs	Black <input type="checkbox"/>	FC2	1SNA007865R2600	100	2.00	
6 Fastening kits		VSJ6	1SNA167735R2700	1		
		RDJ6	1SNA173241R0600	1000	0.10	
7 Terminal block markers	White <input type="checkbox"/>	RC610	1SNA233000R0100	10	7.50	
		RC810	1SNA234000R0200	10	8.20	

HD6/8.2G.2G.2 Quick connect terminal blocks

Feed-through - 8 mm 0.315 in spacing



6 mm²

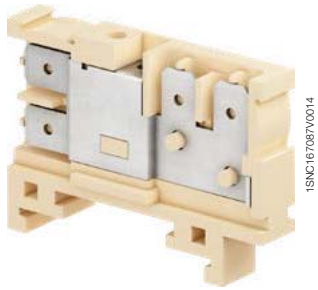

1SNC167087V0014

HD6/8.2G.2G.2

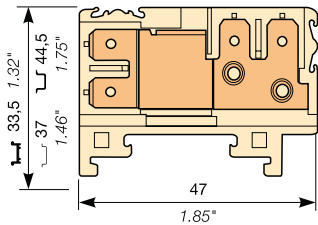

8 mm 0.315 in spacing

Description

- Connection by 2 longitudinal tabs on one side and 2 vertical tabs on the other side for quick-connect 6.3 x 0.8 mm 0.248 x 0.031 in,
- Possibility of testing and transverse connection,
- Use of jumper bars requires to cut out the precut partition.

Ordering details

Description	Color	Type	Part Numbers	Pkg qty	Weight (1 pce) g
4 tabs 1 circuit	Beige <input type="checkbox"/>	HD6/8.2G.2G.2	1SNA160619R1000	50	11.00

Main technical data

Connecting capacity	NF C	DIN	NF F 61-017	Mounting instructions
1 conductor per clamp Quick-connect: 6.3 x 0.8 mm	0.34 ... 6 mm ²			Rail Type 2, TH 35-7.5, TH 35-15
Rated voltage V AC	(Cat. C) 400 V	(Cat. C) 380 V	380 V	
V DC	(Cat. C) 250 V	(Cat. C) 450 V	380 V	
Rated current	25 A	26 A	20 A	
Rated cross section	6 mm ²	6 mm ²		

--	--	--	--	--	--	--	--	--	--

Accessories

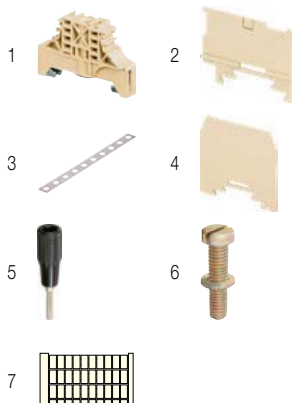

Description	Color	Type	Part Numbers	Pkg qty	Weight (1 pce) g
1 End stops 10 mm 0.394 in	Beige <input type="checkbox"/>	BAM2	1SNA296351R0000	50	12.00
10.7 mm 0.421 in		BAH24	1SNA168355R1300	50	12.00
2 End sections 1 mm 0.039 in	Beige <input type="checkbox"/>	FEH4	1SNA193878R2200	20	1.80
3 Jumper bars 2 poles		BJH8-2	1SNA168456R0100	10	0.60
3 poles		BJH8-3	1SNA168457R0200	10	0.90
4 poles		BJH8-4	1SNA168458R1300	10	1.30
5 poles		BJH8-5	1SNA168459R1400	10	1.60
10 poles		BJH8-10	1SNA168356R1400	10	3.40
4 Circuit separators 1.6 mm 0.063 in	Beige <input type="checkbox"/>	SCH3	1SNA198692R2500	10	4.30
5 Test plugs DIA 2 mm 0.079 in	Black <input type="checkbox"/>	FC2	1SNA007865R2600	100	2.00
6 Fastening kits Screw M2.5x5 for jumper bar BJH		VSJ6	1SNA167735R2700	1	
Washer for screw VSJ		RDJ6	1SNA173241R0600	1000	0.10
7 Terminal block markers Blank card	White <input type="checkbox"/>	RC610	1SNA233000R0100	10	7.50
		RC810	1SNA234000R0200	10	8.20

HD 6/7.5G Quick connect terminal blocks

Feed-through - 7 mm 0.276 in spacing



6 mm²



1SNC167138V0014

HD 6/7.5G

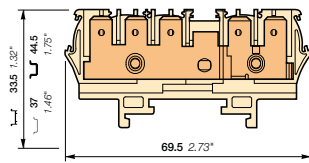

7 mm 0.276 in spacing

Description

- Connection by 5 vertical tabs for quick-connect 6.3 x 0.8 mm 0.248 x 0.031 in,
- Possibility of transverse connection,
- Use of jumper bars requires to cut out the precut partition.

Ordering details

Description	Color	Type	Part Numbers	Pkg qty	Weight (1 pce) g
5 tabs 1 circuit	Beige <input type="checkbox"/>	HD6/7.5G	1SNA400766R1500	25	

Main technical data

Connecting capacity	NF C	DIN	NF F 61-017	Rail	Mounting instructions
1 conductor per clamp Quick-connect: 6.3 x 0.8 mm	0.34 ... 6 mm ²				Type 2, TH 35-7.5, TH 35-15
Rated voltage	V AC	320 V	320 V	320 V	
	V DC	320 V	320 V	320 V	
Rated current		25 A	25 A	20 A	
Rated cross section		6 mm ²	6 mm ²		

Mounting instructions

--	--	--	--	--	--

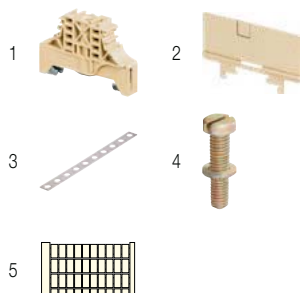

Accessories

Description	Color	Type	Part Numbers	Pkg qty	Weight (1 pce) g	
1 End stops	Beige <input type="checkbox"/>	BAM2	1SNA296351R0000	50	12.00	
		BAH24	1SNA168355R1300	50	12.00	
2 End sections	Beige <input type="checkbox"/>	FEHD1	1SNA199400R0600	20	2.00	
3 Jumper bars		2 poles	BJH7-2	1SNA168486R2000	10	0.50
		3 poles	BJH7-3	1SNA168487R2100	10	0.80
		10 poles	BJH7-10	1SNA168490R0000	10	3.00
4 Fastening kits		Screw M2.5X5 for jumper bar BJH	VSJ6	1SNA167735R2700	1	
		Washer for screw VSJ	RDJ6	1SNA173241R0600	1000	0.10
5 Terminal block markers	White <input type="checkbox"/>	RC610	1SNA233000R0100	10	7.50	

5

1SNC167054S0201

HD 6/7.3G.2G Quick connect terminal blocks

Feed-through - 7 mm 0.276 in spacing



6 mm²



1SNC167140V0014

HD 6/7.3G.2G

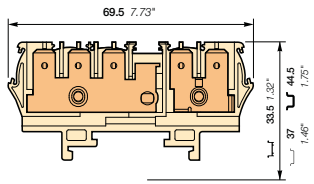

7 mm 0.276 in spacing

Description

- 2 circuits: 1 circuit with 3 vertical tabs for quick-connect 6.3 x 0.8 mm 0.248 x 0.031 in, possibility of transverse connection and 1 circuit with 2 vertical tabs for quick-connect 6.3 x 0.8 mm 0.248 x 0.031 in, marked in red,
- Use of jumper bars requires to cut out the precut partition.

Ordering details

Description	Color	Type	Part Numbers	Pkg qty	Weight (1 pce) g
5 tabs 2 circuits	Beige <input type="checkbox"/>	HD6/7.3G.2G	1SNA400767R1600	25	

Main technical data

Connecting capacity	NF C	DIN	NF F 61-017	Mounting instructions
1 conductor per clamp	Quick-connect: 6.3 x 0.8 mm	0.34 ... 6 mm ²		Rail Type 2, TH 35-7.5, TH 35-15
Rated voltage	V AC	320 V	320 V	320 V
	V DC	320 V	320 V	320 V
Rated current		25 A	25 A	20 A
Rated cross section		6 mm ²	6 mm ²	

--	--	--	--	--	--	--	--	--	--	--

5

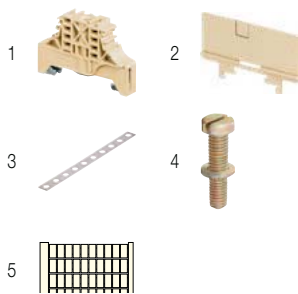

Accessories

Description	Color	Type	Part Numbers	Pkg qty	Weight (1 pce) g	
1 End stops	Beige <input type="checkbox"/>	BAM2	1SNA296351R0000	50	12.00	
		BAH24	1SNA168355R1300	50	12.00	
2 End sections	Beige <input type="checkbox"/>	FEHD1	1SNA199400R0600	20	2.00	
3 Jumper bars		2 poles	BJH7-2	1SNA168486R2000	10	0.50
		3 poles	BJH7-3	1SNA168487R2100	10	0.80
		10 poles	BJH7-10	1SNA168490R0000	10	3.00
4 Fastening kits		Screw M2.5x5 for jumper bar BJH	V SJ6	1SNA167735R2700	1	
		Washer for screw VSJ	RDJ6	1SNA173241R0600	1000	0.10
5 Terminal block markers	White <input type="checkbox"/>	RC610	1SNA233000R0100	10	7.50	

1SNC167035S0201

HD 6/7.2G.3G Quick connect terminal blocks

Feed-through - 7 mm 0.276 in spacing



6 mm²

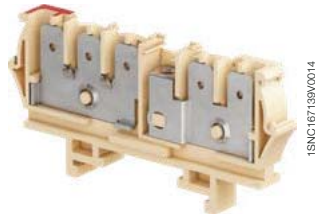

1SNC167139W0014

HD 6/7.2G.3G

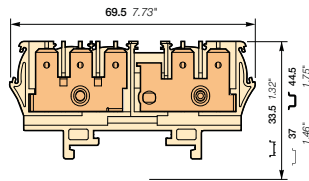

7 mm 0.276 in spacing

Description

- 2 circuits: 1 circuit with 3 vertical tabs for quick-connect 6.3 x 0.8 mm 0.248 x 0.031 in, marked in red and 1 circuit with 2 vertical tabs for quick-connect 6.3 x 0.8 mm 0.248 x 0.031 in, possibility of transverse connection,
- Use of jumper bars requires to cut out the precut partition.

Ordering details

Description	Color	Type	Part Numbers	Pkg qty	Weight (1 pce) g
5 tabs 2 circuits	Beige <input type="checkbox"/>	HD6/7.2G.3G	1SNA400768R2700	25	

Main technical data

Connecting capacity	NF C	DIN	NF F 61-017	Rail	Mounting instructions
1 conductor per clamp	Quick-connect: 6.3 x 0.8 mm	0.34 ... 6 mm ²			Type 2, TH 35-7.5, TH 35-15
Rated voltage	V AC	320 V	320 V	320 V	
	V DC	320 V	320 V	320 V	
Rated current		25 A	25 A	20 A	
Rated cross section		6 mm ²	6 mm ²		

<input type="checkbox"/> CE	<input type="checkbox"/> RoHS	<input type="checkbox"/> EAC							
-----------------------------	-------------------------------	------------------------------	--	--	--	--	--	--	--

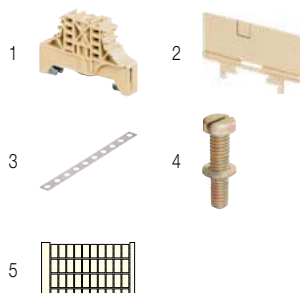

Accessories

Description	Color	Type	Part Numbers	Pkg qty	Weight (1 pce) g	
1 End stops	Beige <input type="checkbox"/>	BAM2	1SNA296351R0000	50	12.00	
		BAH24	1SNA168355R1300	50	12.00	
2 End sections	Beige <input type="checkbox"/>	FEHD1	1SNA199400R0600	20	2.00	
3 Jumper bars		2 poles	BJH7-2	1SNA168486R2000	10	0.50
		3 poles	BJH7-3	1SNA168487R2100	10	0.80
		10 poles	BJH7-10	1SNA168490R0000	10	3.00
4 Fastening kits		Screw M2.5X5 for jumper bar BJH	VSJ6	1SNA167735R2700	1	
		Washer for screw VSJ	RDJ6	1SNA173241R0600	1000	0.10
5 Terminal block markers	White <input type="checkbox"/>	RC610	1SNA233000R0100	10	7.50	

5

1SNC167052S0201

HD6/9.5G Quick connect terminal blocks

Feed-through - 9 mm 0.354 in spacing

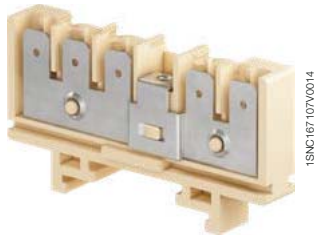

HD6/9.5G

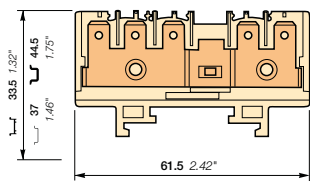

9 mm 0.354 in spacing

Description

- Connection by 5 vertical tabs for quick-connect 6.3 x 0.8 mm 0.248 x 0.031 in,
- Possibility of testing and transverse connection,
- Use of jumper bars requires to cut out the precut partition,
- NF F 61-017 designation: BC0009-3G2G (1SNA160621R0200).

Ordering details

Description	Color	Type	Part Numbers	Pkg qty	Weight (1 pce)
5 tabs 1 circuit	Beige <input type="checkbox"/>	HD6/9.5G	1SNA160621R0200	25	13.00

Main technical data

Connecting capacity	NF C	DIN	NF F 61-017	Rail	Mounting instructions
1 conductor per clamp Quick-connect: 6.3 x 0.8 mm	0.34 ... 6 mm ²			Type 2, TH 35-7.5, TH 35-15	
Rated voltage	V AC (Cat. C) 400 V	(Cat. C) 380 V	380 V		
	V DC (Cat. C) 250 V	(Cat. C) 450 V	380 V		
Rated current	25 A	26 A	20 A		
Rated cross section	6 mm ²	6 mm ²			

--	--	--	--	--	--	--	--	--	--

Accessories

Description	Color	Type	Part Numbers	Pkg qty	Weight (1 pce)
1 End stops 10 mm 0.394 in	Beige <input type="checkbox"/>	BAM2	1SNA296351R0000	50	12.00
10.7 mm 0.421 in		BAH24	1SNA168355R1300	50	12.00
2 End sections 1 mm 0.039 in	Beige <input type="checkbox"/>	FEHD1	1SNA199400R0600	20	2.00
3 Jumper bars 2 poles		BJH9-2	1SNA168460R1100	10	1.60
3 poles		BJH9-3	1SNA168461R0600	10	1.00
4 poles		BJH9-4	1SNA168462R0700	10	1.40
5 poles		BJH9-5	1SNA168463R0000	10	1.80
10 poles		BJH9-10	1SNA168357R1500	10	3.80
4 Test plugs DIA 2 mm 0.079 in	Black <input type="checkbox"/>	FC2	1SNA007865R2600	100	2.00
5 Fastening kits Screw M2.5x5 for jumper bar BJH		VSJ6	1SNA167735R2700	1	
Washer for screw VSJ		RDJ6	1SNA173241R0600	1000	0.10
6 Terminal block markers Blank card	White <input type="checkbox"/>	RC510	1SNA231000R0700	10	5.20

HD6/9.3G.2G Quick connect terminal blocks

Feed-through - 9 mm 0.354 in spacing

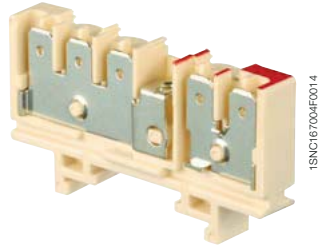

HD6/9.3G.2G

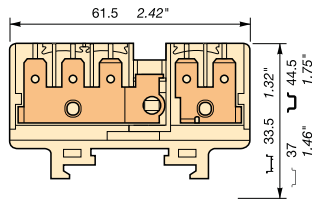

9 mm 0.354 in spacing

Description

- 2 circuits: 1 circuit with 3 vertical tabs for quick-connect 6.3 x 0.8 mm 0.248 x 0.031 in, possibility of testing and transverse connection and 1 circuit with 2 vertical tabs for quick-connect 6.3 x 0.8 mm 0.248 x 0.031 in, marked in red,
- Use of jumper bars requires to cut out the precut partition,
- NF F 61-017 designation: BK0009-3Ge/2G (1SNA160563R0000).

Ordering details

Description	Color	Type	Part Numbers	Pkg qty	Weight (1 pce) g
5 tabs 2 circuits	Beige <input type="checkbox"/>	HD6/9.3G.2G	1SNA160563R0000	25	13.00

Main technical data

Connecting capacity	NF C	DIN	NF F 61-017	Mounting instructions
1 conductor per clamp Quick-connect: 6.3 x 0.8 mm	0.34 ... 6 mm ²			Rail Type 2, TH 35-7.5, TH 35-15
Rated voltage V AC	(Cat. C) 400 V	(Cat. C) 380 V	380 V	
V DC	(Cat. C) 250 V	(Cat. C) 450 V	380 V	
Rated current	25 A	26 A	20 A	
Rated cross section	6 mm ²	6 mm ²		

--	--	--	--	--	--	--	--	--	--	--	--	--	--	--	--	--	--	--	--

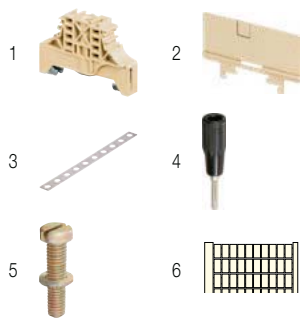

Accessories

Description	Color	Type	Part Numbers	Pkg qty	Weight (1 pce) g
1 End stops 10 mm 0.394 in 10.7 mm 0.421 in	Beige <input type="checkbox"/>	BAM2	1SNA296351R0000	50	12.00
2 End sections 1 mm 0.039 in	Beige <input type="checkbox"/>	FEHD1	1SNA199400R0600	20	2.00
3 Jumper bars 2 poles		BJH9-2	1SNA168460R1100	10	1.60
3 poles		BJH9-3	1SNA168461R0600	10	1.00
4 poles		BJH9-4	1SNA168462R0700	10	1.40
5 poles		BJH9-5	1SNA168463R0000	10	1.80
10 poles		BJH9-10	1SNA168357R1500	10	3.80
4 Test plugs DIA 2 mm 0.079 in	Black <input type="checkbox"/>	FC2	1SNA007865R2600	100	2.00
5 Fastening kits Screw M2.5X5 for jumper bar BJH		VSJ6	1SNA167735R2700	1	
Washer for screw VSJ		RDJ6	1SNA173241R0600	1000	0.10
6 Terminal block markers Blank card	White <input type="checkbox"/>	RC510	1SNA231000R0700	10	5.20

1SNC167077S0201

HD6/9.2G.3G Quick connect terminal blocks

Feed-through - 9 mm 0.354 in spacing



6 mm²

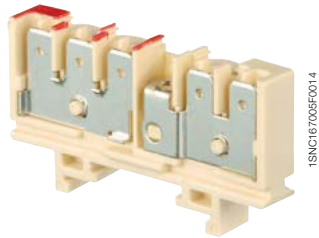

1SNC16700DF0014

HD6/9.2G.3G

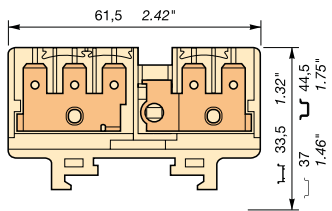

9 mm 0.354 in spacing

Description

- 2 circuits: 1 circuit with 3 vertical tabs for quick-connect 6.3 x 0.8 mm 0.248 x 0.031 in, marked in red and 1 circuit with 2 vertical tabs for quick-connect 6.3 x 0.8 mm 0.248 x 0.031 in, possibility of testing and transverse connection,
- Use of jumper bars requires to cut out the precut partition,
- NF F 61-017 designation: BK0009-3G/2Ge (1SNA160564R0100).

Ordering details



Description	Color	Type	Part Numbers	Pkg qty	Weight (1 pce) g
5 tabs 2 circuits	Beige <input type="checkbox"/>	HD6/9.2G.3G	1SNA160564R0100	25	13.00

Main technical data

Connecting capacity	NF C	DIN	NF F 61-017	Mounting instructions
1 conductor per clamp Quick-connect: 6.3 x 0.8 mm	0.34 ... 6 mm ²			Rail  Type 2, TH 35-7.5, TH 35-15
Rated voltage V AC	(Cat. C) 400 V	(Cat. C) 380 V	380 V	
V DC	(Cat. C) 250 V	(Cat. C) 450 V	380 V	
Rated current	25 A	26 A	20 A	
Rated cross section	6 mm ²	6 mm ²		

									
---	---	---	--	--	--	--	--	--	--

Accessories

Description	Color	Type	Part Numbers	Pkg qty	Weight (1 pce) g
1 End stops 10 mm 0.394 in 	Beige <input type="checkbox"/>	BAM2	1SNA296351R0000	50	12.00
10.7 mm 0.421 in 		BAH24	1SNA168355R1300	50	12.00
2 End sections 1 mm 0.039 in	Beige <input type="checkbox"/>	FEHD1	1SNA199400R0600	20	2.00
3 Jumper bars 2 poles		BJH9-2	1SNA168460R1100	10	1.60
3 poles		BJH9-3	1SNA168461R0600	10	1.00
4 poles		BJH9-4	1SNA168462R0700	10	1.40
5 poles		BJH9-5	1SNA168463R0000	10	1.80
10 poles		BJH9-10	1SNA168357R1500	10	3.80
4 Test plugs DIA 2 mm 0.079 in	Black <input type="checkbox"/>	FC2	1SNA007865R2600	100	2.00
5 Fastening kits Screw M2.5x5 for jumper bar BJH		VSJ6	1SNA167735R2700	1	
Washer for screw VSJ		RDJ6	1SNA173241R0600	1000	0.10
6 Terminal block markers Blank card	White <input type="checkbox"/>	RC510	1SNA231000R0700	10	5.20

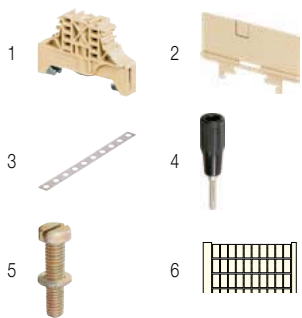

HD6/22.F12G stud terminal blocks

Feed-through - 22 mm 0.866 in spacing



Description

- 115 A main circuit: 1 stud terminal M6 x 31.5 mm 1.24 in,
- Equipment: H 130 self locking nut + TREP 3L washer + washer,
- Branch by 12 tabs for quick-connect 6.3 x 0.8 mm 0.248 x 0.031 in: 16 A maximum per tab,
- NF F 61-017 designation: BF0025-1F12G.



HD6/22.F12G

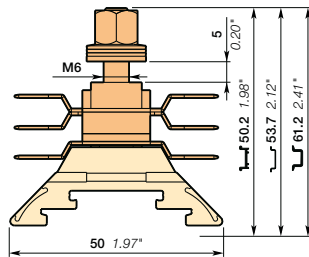

22 mm 0.866 in spacing

Ordering details

Description	Color	Type	Part Numbers	Pkg qty	Weight (1 pce) g
1 stud M6 and 12 tabs 1 circuit	Beige <input type="checkbox"/>	HD6/22.F12G	1SNA400782R0000	10	55.00

Main technical data

Connecting capacity	NF C	DIN	NF F 61-017	Rail	Tool	Type 2, TH 35-7.5, TH 35-15
Wire size	Lug (NF C 20-130)	1.5 ... 35 mm ²				Wrench
	Lug (DIN 46235 / 46234)	2.5 ... 35 mm ²				Ø 10 mm
	Quick-connect: 6.3 x 0.8 mm	0.34 ... 2.5 mm ²				Ø 0.394 in
Rated voltage	V AC		400 V	Torque		5.3 N.m
	V DC		500 V			
Rated current			115/16 A			46.9 lb.in
Rated cross section		35 mm ²				

Mounting instructions

CE	RoHS	ERC	EAC
<input type="checkbox"/>	<input type="checkbox"/>	<input type="checkbox"/>	<input type="checkbox"/>

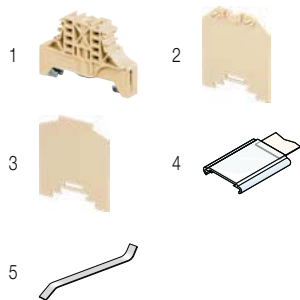

Accessories

Description	Color	Type	Part Numbers	Pkg qty	Weight (1 pce) g
1 End stops	Beige <input type="checkbox"/>	BAM2	1SNA296351R0000	50	12.00
		BAH22	1SNA164655R0400	50	10.00
2 End sections	Beige <input type="checkbox"/>	FJH501	1SNA199411R1400	25	6.50
3 Circuit separators	Beige <input type="checkbox"/>	SCH8	1SNA199412R1500	25	4.80
4 Protecting covers	Transparent <input checked="" type="checkbox"/>	CPM	1SNA187312R1400	1	25.00
		CPM	1SNA197312R1600	10	25.00
5 Terminal block markers	White <input type="checkbox"/>	RTC	1SNA163156R2700	1	10.00
		PEFH	1SNA163497R1600	10	12.00
		RPED	1SNA163518R2200	1	12.00
		RC610	1SNA233000R0100	10	7.50

HD6/30.F12G stud terminal blocks

Feed-through - 30 mm 1.18 in spacing



HD6/30.F12G

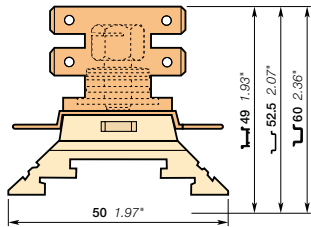

30 mm 1.18 in spacing

Description

- 155 A main circuit: 1 stud terminal M6 x 19.5 mm 0.768 in,
- Equipment: H 130 self locking nut + TREP 3L washer + washer,
- Branch by 12 tabs for quick-connect 6.3 x 0.8 mm 0.248 x 0.031 in: 16 A maximum per tab,
- NF F 61-017 designation: BF31.2-1F12G (1SNA295015R1200 + SCH8).

Ordering details

Description	Color	Type	Part Numbers	Pkg qty	Weight (1 pce)
1 stud M6 and 12 tabs 1 circuit	Beige <input type="checkbox"/>	HD6/30.F12G	1SNA295015R1200	10	42.00

Main technical data

Connecting capacity	NF C	DIN	NF F 61-017	Rail	Tool	Torque
Wire size	Lug (NF C 20-130) Lug (DIN 46235 / 46234) Quick-connect: 6.3 x 0.8 mm	1.5 ... 35 mm² 2.5 ... 35 mm² 0.34 ... 6 mm²		Type 2, TH 35-7.5, TH 35-15	Wrench Ø 10 mm Ø 0.394 in	5.3 N.m 46.9 lb.in
Rated voltage	V AC V DC	(Cat. C) 750 V (Cat. C) 750 V	(Cat. C) 750 V : 380 V (Cat. C) 900 V : 500 V			
Rated current			155/16 A			
Rated cross section		35 mm²				

Mounting instructions

<input checked="" type="checkbox"/> CE	<input checked="" type="checkbox"/> RoHS	<input checked="" type="checkbox"/> EAC				
--	--	---	--	--	--	--

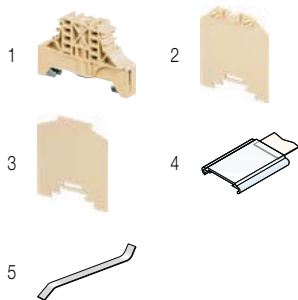

Accessories

Description	Color	Type	Part Numbers	Pkg qty	Weight (1 pce)
1 End stops	Beige <input type="checkbox"/>	BAM2	1SNA296351R0000	50	12.00
2 End sections	Beige <input type="checkbox"/>	BAH22	1SNA164655R0400	50	10.00
3 Circuit separators	Beige <input type="checkbox"/>	FJH501	1SNA199411R1400	25	6.50
4 Protecting covers	Beige <input type="checkbox"/>	SCH8	1SNA199412R1500	25	4.80
5 Terminal block markers	Transparent <input type="checkbox"/>	CPM	1SNA187312R1400	1	25.00
	Beige <input type="checkbox"/>	CPM	1SNA197312R1600	10	25.00
	White <input type="checkbox"/>	RTC	1SNA163156R2700	1	10.00
		PEFH	1SNA163497R1600	10	
		RPED	1SNA163518R2200	1	12.00
	White <input type="checkbox"/>	RC610	1SNA233000R0100	10	7.50

HD6/14.SF Quick connect terminal blocks

For 5x20 fuse - 14 mm 0.551 in spacing



6 mm²

Description

- Terminal block for 5x20 fuse,
- Connection by 2 tabs for quick-connect 6.3 x 0.8 mm 0.248 x 0.031 in on each side.



1SNMC16715FF001.4

HD6/14.SF

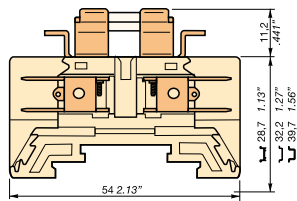

14 mm 0.551 in spacing

Ordering details

Description	Color	Type	Part Numbers	Pkg qty	Weight (1 pce) g
2 tabs on each side	Beige <input type="checkbox"/>	HD6/14.SF.2G.2G	1SNA162315R2500	10	17.00

Main technical data

Connecting capacity	NF C	DIN	NF F 61-017	Mounting instructions	
1 conductor per clamp	Quick-connect: 6.3 x 0.8 mm	0.34 ... 6 mm ²		Rail	Type 2, TH 35-7.5, TH 35-15
Rated voltage	V AC (Cat. C) 500 V	(Cat. C) 500 V	(Cat. C) 500 V		
	V DC (Cat. C) 500 V	(Cat. C) 500 V	(Cat. C) 600 V		
Rated current	25 A	25 A	26 A		
Rated cross section	6 mm ²	6 mm ²	6 mm ²		

CE	RoHS	EAC																	
----	------	-----	--	--	--	--	--	--	--	--	--	--	--	--	--	--	--	--	--

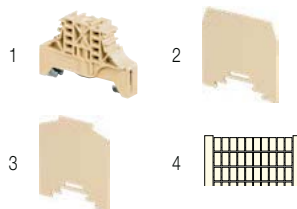

Accessories

Description	Color	Type	Part Numbers	Pkg qty	Weight (1 pce) g
1 End stops	Beige <input type="checkbox"/>	BAM2	1SNA296351R0000	50	12.00
		BAH24	1SNA168355R1300	50	12.00
2 End sections	Beige <input type="checkbox"/>	FEH9	1SNA198549R0500	10	4.30
3 Circuit separators	Beige <input type="checkbox"/>	SCH8	1SNA199412R1500	25	4.80
4 Terminal block markers	White <input type="checkbox"/>	RC610	1SNA233000R0100	10	7.50

5

1SNMC167073S0201

HD6/24.DH Quick connect terminal blocks

Component holder - 24 mm 0.945 in spacing



6 mm²



1SNC167029/0014

HD6/24.DH

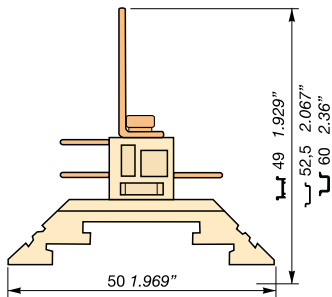

24 mm 0.945 in spacing

Description

- Terminal block for screw and solder diodes type SKN5 or SKNa4,
- Connection by 6 or 8 tabs for quick disconnects 6.3 x 0.8 mm 0.248 x 0.031 in,
- NF F 61-017 designation: BG25.2-2G2G (HD6/24.DH + SCH8).

Ordering details

Description	Color	Type	Part Numbers	Pkg qty	Weight (1 pce) g
6 tabs	Beige <input type="checkbox"/>	HD6/24.DH	1SNA399964R0600	10	20.00
8 tabs	Beige <input type="checkbox"/>	HD6/24.DH	1SNA399963R0500	10	20.00

Main technical data

Connecting capacity	NF C	DIN	NF F 61-017
1 conductor per clamp	Quick-connect: 6.3 x 0.8 mm	0.34 ... 6 mm ²	
Rated voltage	V AC (Cat. C) 400 V	(Cat. C) 250 V	250 V
	V DC (Cat. C) 250 V	(Cat. C) 250 V	250 V
Rated current	25 A	26 A	16 A
Rated cross section	6 mm ²	6 mm ²	

Mounting instructions

Rail	Type 2, TH 35-7.5, TH 35-15

--	--	--	--	--	--	--	--	--	--	--	--	--	--	--	--	--	--	--	--

Accessories

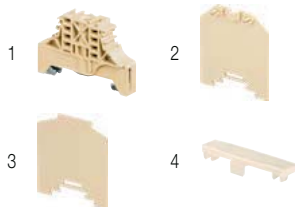

Description	Color	Type	Part Numbers	Pkg qty	Weight (1 pce) g
1 End stops	Beige <input type="checkbox"/>	BAM2	1SNA296351R0000	50	12.00
		BAH24	1SNA168355R1300	50	12.00
2 End sections	Beige <input type="checkbox"/>	FJH501	1SNA199411R1400	25	6.50
3 Circuit separators	Beige <input type="checkbox"/>	SCH8	1SNA199412R1500	25	4.80
4 Terminal block markers		PEFH	1SNA163497R1600	10	
		RPED	1SNA163518R2200	1	12.00
	White <input type="checkbox"/>	RC610	1SNA233000R0100	10	7.50

HD6/14.DH Quick connect terminal blocks

Component holder - 14 mm 0.551 in spacing



6 mm²

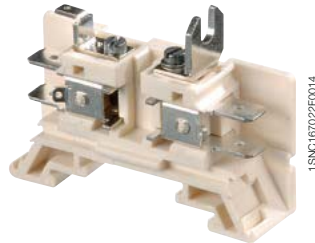

1SNC167022R0014

HD6/14.DH

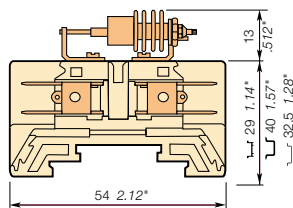

14 mm 0.551 in spacing

Description

- Terminal block for screw and solder diodes type SKN2.5 or SKNa2,
- Connection by 2 tabs for quick disconnects 6.3 x 0.8 mm 0.248 x 0.031 in on each side,
- NF F 61-017 designation: BG0014-2G2G (1SNA162971R2700).

Ordering details

Description	Color	Type	Part Numbers	Pkg qty	Weight (1 pce) g
2 tabs on each side	Beige <input type="checkbox"/>	HD6/14.DH	1SNA162971R2700	10	20.00

Main technical data

Connecting capacity	NF C	DIN	NF F 61-017	Mounting instructions
1 conductor per clamp	Quick-connect: 6.3 x 0.8 mm	0.34 ... 6 mm ²		Rail Type 2, TH 35-7.5, TH 35-15
Rated voltage	V AC	(Cat. C) 500 V	(Cat. C) 500 V	380 V
	V DC	(Cat. C) 500 V	(Cat. C) 600 V	500 V
Rated current		25 A	26 A	12 A
	Rated cross section	6 mm ²	6 mm ²	

--	--	--	--	--	--	--	--	--	--	--	--	--	--	--	--	--	--	--	--

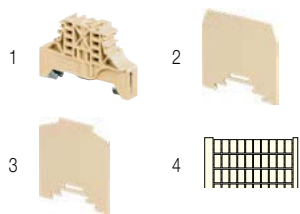

Accessories

Description	Color	Type	Part Numbers	Pkg qty	Weight (1 pce) g
1 End stops	Beige <input type="checkbox"/>		BAM2	1SNA296351R0000	50 12.00
			BAH24	1SNA168355R1300	50 12.00
2 End sections	Beige <input type="checkbox"/>		FEH9	1SNA198549R0500	10 4.30
3 Circuit separators	Beige <input type="checkbox"/>		SCH8	1SNA199412R1500	25 4.80
4 Terminal block markers	White <input type="checkbox"/>		RC610	1SNA233000R0100	10 7.50

HD6/14.DG Quick connect terminal blocks

Component holder - 14 mm 0.551 in spacing



6 mm²



1SNC167091V0014

HD6/14.DG

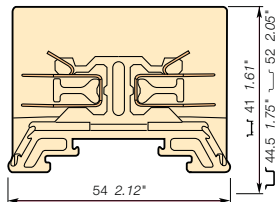

14 mm 0.551 in spacing

Description

- Terminal block for solder diodes or resistors,
- Connection by 2 tabs for quick-connect 6.3 x 0.8 mm 0.248 x 0.031 in on each side,
- NF F 61-017 designation: BG0014-2G2G (1SNA162309R1000).

Ordering details

Description	Color	Type	Part Numbers	Pkg qty	Weight (1 pce) g
2 tabs on each side	Beige <input type="checkbox"/>	HD6/14.DG	1SNA162309R1000	10	20.00

Main technical data

Connecting capacity	NF C	DIN	NF F 61-017	Rail	Mounting instructions
1 conductor per clamp	Quick-connect: 6.3 x 0.8 mm	0.34 ... 6 mm ²			Type 2, TH 35-7.5, TH 35-15
Rated voltage	V AC	(Cat. C) 500 V	(Cat. C) 500 V	380 V	
	V DC	(Cat. C) 500 V	(Cat. C) 600 V	500 V	
Rated current		25 A	26 A	12 A	
Rated cross section		6 mm ²	6 mm ²		

CE	RoHS	ERC	EAC						
----	------	-----	-----	--	--	--	--	--	--

5

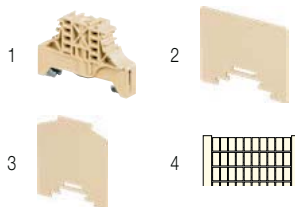

Accessories

Description	Color	Type	Part Numbers	Pkg qty	Weight (1 pce) g
1 End stops	Beige <input type="checkbox"/>	BAM2	1SNA296351R0000	50	12.00
		BAH24	1SNA168355R1300	50	12.00
2 End sections	Beige <input type="checkbox"/>	FEH8	1SNA198729R0100	25	4.30
3 Circuit separators	Beige <input type="checkbox"/>	SCH8	1SNA199412R1500	25	4.80
4 Terminal block markers	White <input type="checkbox"/>	RC610	1SNA233000R0100	10	7.50

1SNC167020S0201

HD6/9.SDH.1 Quick connect terminal blocks

Component holder - 9.2 mm 0.362 in spacing

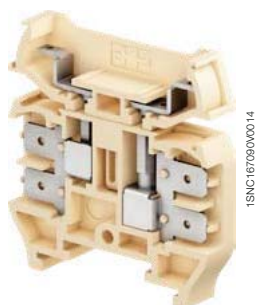

HD6/9.SDH.1

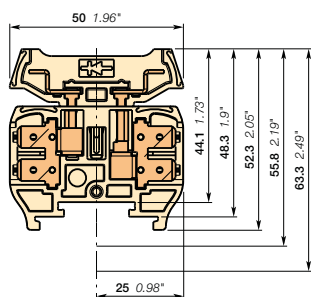

9.2 mm 0.362 in spacing



Description

- Connection interruptible by plugs for solder components DIA 7 mm 0.287 in max,
- Connection by 2 tabs for quick disconnects 6.3 x 0.8 mm 0.248 x 0.031 in on each side,
- NF F 61-017 designation: BH09.2-2G2G (1SNA162309R1000).

Ordering details

Description	Color	Type	Part Numbers	Pkg qty	Weight (1 pce) g
4 tabs	Beige <input type="checkbox"/>	HD6/9.SDH.1	1SNA400800R0000	25	

Main technical data

Connecting capacity	NF C	DIN	NF F 61-017	Rail	Mounting instructions
1 conductor per clamp	Quick-connect: 6.3 x 0.8 mm	0.34 ... 6 mm ²			Type 2, TH 35-7.5, TH 35-15
Rated voltage	V AC		380 V		
	V DC		500 V		
Rated current			16 A		
Rated cross section		6 mm ²			

CE	RoHS	ERC																	
CE	RoHS	ERC	EAC																

Accessories

Description	Color	Type	Part Numbers	Pkg qty	Weight (1 pce) g
1 End stops	Beige <input type="checkbox"/>	BAM2	1SNA296351R0000	50	12.00
		BAH24	1SNA168355R1300	50	12.00
2 End sections	Beige <input type="checkbox"/>	FESDH	1SNA400799R0000	10	
3 Circuit separators	Beige <input type="checkbox"/>	SCH8	1SNA199412R1500	25	4.80
4 Terminal block markers	White <input type="checkbox"/>	RC810	1SNA234000R0200	10	8.20

1SNAC167051S0201

HD6/14.SDH.1 Quick connect terminal blocks

Component holder - 14 mm 0.551 in spacing



6 mm²

Description

- Connection interruptible by plugs for solder components,
- Connection by 2 tabs for quick disconnects 6.3 x 0.8 mm 0.248 x 0.031 in on each side,
- NF F 61-017 designation: BH0014-2G2G (1SNA162988R2100).

Ordering details

Description	Color	Type	Part Numbers	Pkg qty	Weight (1 pce) g
2 tabs on each side	Beige <input type="checkbox"/>	HD6/14.SDH.1	1SNA162988R2100	10	30.00

Main technical data

Connecting capacity	NF C	DIN	NF F 61-017	Mounting instructions
1 conductor per clamp	Quick-connect: 6.3 x 0.8 mm	0.34 ... 6 mm ²		Rail Type 2, TH 35-7.5, TH 35-15
Rated voltage	V AC	(Cat. C) 500 V	(Cat. C) 500 V	380 V
	V DC	(Cat. C) 500 V	(Cat. C) 600 V	500 V
Rated current		25 A	26 A	16 A
Rated cross section		6 mm ²	6 mm ²	

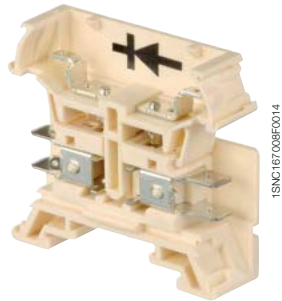

1SNC167068S02014

HD6/14.SDH.1

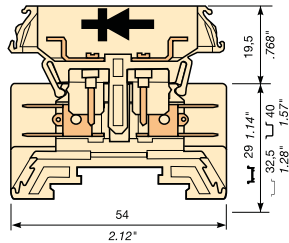

14 mm 0.551 in spacing

--	--	--	--	--	--	--	--	--	--

Accessories

Description	Color	Type	Part Numbers	Pkg qty	Weight (1 pce) g
1 End stops	Beige <input type="checkbox"/>	BAM2	1SNA296351R0000	50	12.00
		BAH24	1SNA168355R1300	50	12.00
2 End sections	Beige <input type="checkbox"/>	FEH9	1SNA198549R0500	10	4.30
3 Circuit separators	Beige <input type="checkbox"/>	SCH8	1SNA199412R1500	25	4.80
4 Terminal block markers	White <input type="checkbox"/>	RC610	1SNA233000R0100	10	7.50

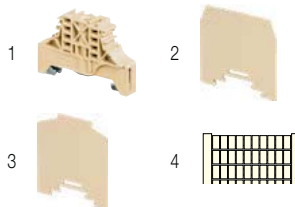

1SNC167068S0201

HD6/14.SDH Quick connect terminal blocks

Component holder - 14 mm 0.551 in spacing



6 mm²

Description

- Terminal block for screw and solder diodes type SKN2.5 or SKNa2,
- Connection by 2 tabs for quick disconnects 6.3 x 0.8 mm 0.248 x 0.031 in on each side,
- NF F 61-017 designation: BH0014-2G2G (1SNA162972R2000).



1SNC1670590014

HD6/14.SDH

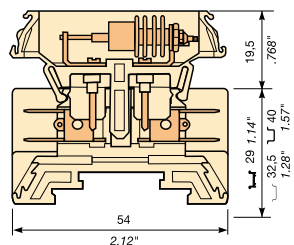

14 mm 0.551 in spacing

Ordering details

Description	Color	Type	Part Numbers	Pkg qty	Weight (1 pce) g
2 tabs on each side	Beige <input type="checkbox"/>	HD6/14.SDH	1SNA162972R2000	10	30.00

Main technical data

Connecting capacity	NF C	DIN	NF F 61-017	Rail	Mounting instructions
1 conductor per clamp	Quick-connect: 6.3 x 0.8 mm	0.34 ... 6 mm ²			Type 2, TH 35-7.5, TH 35-15
Rated voltage	V AC	(Cat. C) 500 V	(Cat. C) 500 V	380 V	
	V DC	(Cat. C) 500 V	(Cat. C) 600 V	500 V	
Rated current		25 A	26 A	16 A	
		6 mm ²	6 mm ²		

Mounting instructions

CE	RoHS	EAC																	
----	------	-----	--	--	--	--	--	--	--	--	--	--	--	--	--	--	--	--	--

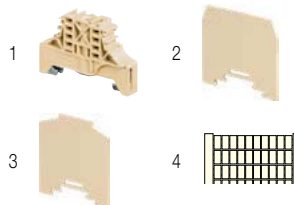

Accessories

Description	Color	Type	Part Numbers	Pkg qty	Weight (1 pce) g
1 End stops	Beige <input type="checkbox"/>	BAM2	1SNA296351R0000	50	12.00
				50	12.00
2 End sections	Beige <input type="checkbox"/>	FEH9	1SNA198549R0500	10	4.30
3 Circuit separators	Beige <input type="checkbox"/>	SCH8	1SNA199412R1500	25	4.80
4 Terminal block markers	White <input type="checkbox"/>	RC610	1SNA233000R0100	10	7.50

1SNC1670699S0201

HD2.5/6.3.3G.3G.1 Quick connect terminal blocks

Feed-through - 6 mm 0.236 in spacing



Description

- Connection by 6 longitudinal tabs for quick-connect 6.3 x 0.8 mm 0.248 x 0.031 in,
- Possibility of testing and transverse connection,
- Use of jumper bars requires to cut out the precut partition.

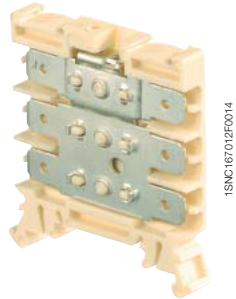

HD2.5/6.3.3G.3G.1

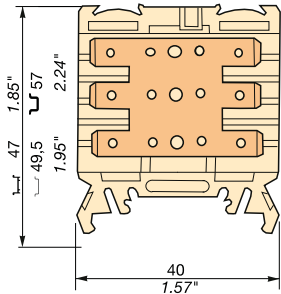

6 mm 0.236 in spacing

Ordering details

Description	Color	Type	Part Numbers	Pkg qty	Weight (1 pce) g
6 tabs 1 circuit	Beige <input type="checkbox"/>	HD2.5/6.3.3G.3G.1	1SNA190316R2700	50	11.00

Main technical data

Connecting capacity	NF C	DIN	NF F 61-017	Mounting instructions
1 conductor per clamp Quick-connect: 6.3 x 0.8 mm	0.34 ... 2.5 mm ²			Rail Type 2, TH 35-7.5, TH 35-15
Rated voltage V AC	(Cat. C) 250 V	(Cat. C) 250 V		
V DC	(Cat. C) 250 V	(Cat. C) 300 V		
Rated current	25 A			
Rated cross section	2.5 mm ²			

--	--	--	--	--	--	--	--	--	--	--	--	--	--	--	--	--	--	--	--

Accessories

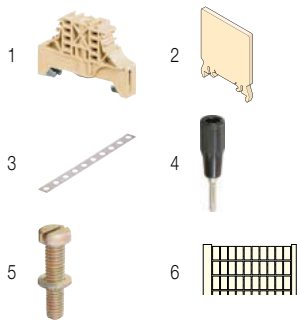

Description	Color	Type	Part Numbers	Pkg qty	Weight (1 pce) g
1 End stops 10 mm 0.394 in 10.7 mm 0.421 in	Beige <input type="checkbox"/>	BAM2	1SNA296351R0000	50	12.00
2 End sections 1 mm 0.039 in	Beige <input type="checkbox"/>	BAH24	1SNA168355R1300	50	12.00
3 Jumper bars 2 poles 32 A (IEC)		BJS61-2	1SNA168481R2300	10	1.80
3 poles 32 A (IEC)		BJS61-3	1SNA168482R2400	10	1.80
4 poles 32 A (IEC)		BJS61-4	1SNA168483R2500	10	1.80
5 poles 32 A (IEC)		BJS61-5	1SNA168484R2600	10	1.80
10 poles 32 A (IEC)		BJS61-10	1SNA168485R2700	10	2.00
4 Test plugs DIA 2 mm 0.079 in	Black <input type="checkbox"/>	FC2	1SNA007865R2600	100	2.00
5 Fastening kits Screw M2.5x5 for jumper bar BJH Washer for screw VSJ		VSJ6	1SNA167735R2700	1	
		RDJ6	1SNA173241R0600	1000	0.10
6 Terminal block markers Blank card	White <input type="checkbox"/>	RC610	1SNA233000R0100	10	7.50

1SNC167046S0201

HD2.5/6.3.2G.2G.1.GG Quick connect terminal blocks

Feed-through - 6 mm 0.236 in spacing



Description

- 2 circuits: 1 circuit with 4 longitudinal tabs for quick-connect 6.3 x 0.8 mm 0.248 x 0.031 in, possibility of testing and transverse connection and 1 circuit with 2 longitudinal tabs for quick-connect 6.3 x 0.8 mm 0.248 x 0.031 in,
- Use of jumper bars requires to cut out the precut partition.

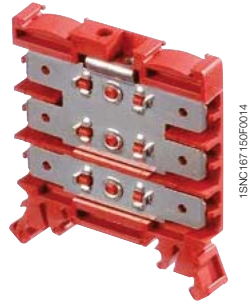

HD2.5/6.3.2G.2G.1.GG

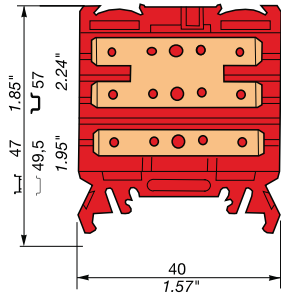

6 mm 0.236 in spacing

Ordering details

Description	Color	Type	Part Numbers	Pkg qty	Weight (1 pce) g
6 tabs 2 circuits	Red	HD2.5/6.3.2G.2G.1.GG	1SNA190312R2300	50	10.00

Main technical data

Connecting capacity	NF C	DIN	NF F 61-017	Mounting instructions
1 conductor per clamp Quick-connect: 6.3 x 0.8 mm	0.34 ... 2.5 mm ²			Rail Type 2, TH 35-7.5, TH 35-15
Rated voltage V AC	(Cat. C) 250 V	(Cat. C) 250 V		
V DC	(Cat. C) 250 V	(Cat. C) 300 V		
Rated current	25 A			
Rated cross section	2.5 mm ²			

CE	RoHS	EAC																	
----	------	-----	--	--	--	--	--	--	--	--	--	--	--	--	--	--	--	--	--

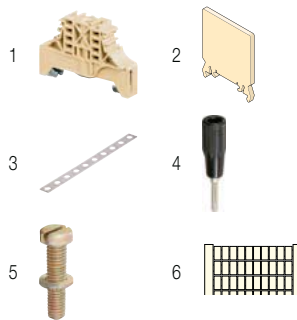

Accessories

Description	Color	Type	Part Numbers	Pkg qty	Weight (1 pce) g
1 End stops 10 mm 0.394 in	Beige	BAM2	1SNA296351R0000	50	12.00
10.7 mm 0.421 in		BAH24	1SNA168355R1300	50	12.00
2 End sections 1 mm 0.039 in	Beige	FEHD2	1SNA168949R1700	20	2.00
3 Jumper bars 2 poles 32 A (IEC)		BJS61-2	1SNA168481R2300	10	1.80
3 poles 32 A (IEC)		BJS61-3	1SNA168482R2400	10	1.80
4 poles 32 A (IEC)		BJS61-4	1SNA168483R2500	10	1.80
5 poles 32 A (IEC)		BJS61-5	1SNA168484R2600	10	1.80
10 poles 32 A (IEC)		BJS61-10	1SNA168485R2700	10	2.00
4 Test plugs DIA 2 mm 0.079 in	Black	FC2	1SNA007865R2600	100	2.00
5 Fastening kits Screw M2.5X5 for jumper bar BJH		VSJ6	1SNA167735R2700	1	
Washer for screw VSJ		RDJ6	1SNA173241R0600	1000	0.10
6 Terminal block markers Blank card	White	RC610	1SNA233000R0100	10	7.50

HD2.5/6.3.GG1.2G.2G Quick connect terminal blocks

Feed-through - 6 mm 0.236 in spacing



Description

- 2 circuits: 1 circuit with 2 longitudinal tabs for quick-connect 6.3 x 0.8 mm 0.248 x 0.031 in, possibility of testing and transverse connection and 1 circuit with 4 longitudinal tabs for quick-connect 6.3 x 0.8 mm 0.248 x 0.031 in,
- Use of jumper bars requires to cut out the precut partition.

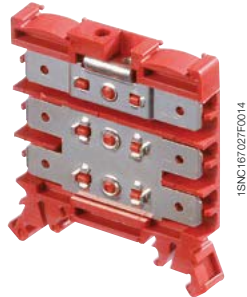

HD2.5/6.3.GG1.2G.2G

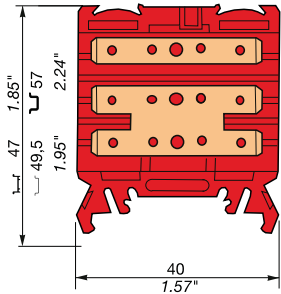

6 mm 0.236 in spacing

Ordering details

Description	Color	Type	Part Numbers	Pkg qty	Weight (1 pce) g
6 tabs 2 circuits	Red ■	HD2.5/6.3.GG1.2G.2G	1SNA190314R2500	50	11.00

Main technical data

Connecting capacity	NF C	DIN	NF F 61-017	Mounting instructions
1 conductor per clamp Quick-connect: 6.3 x 0.8 mm	0.34 ... 2.5 mm ²			Rail Type 2, TH 35-7.5, TH 35-15
Rated voltage V AC V DC	(Cat. C) 250 V (Cat. C) 250 V	(Cat. C) 250 V (Cat. C) 300 V		
Rated current	25 A			
Rated cross section	2.5 mm ²	2.5 mm ²		

CE	RoHS	RoHS	EAC	EAC						
----	------	------	-----	-----	--	--	--	--	--	--

Accessories

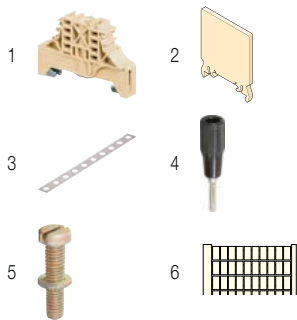

Description	Color	Type	Part Numbers	Pkg qty	Weight (1 pce) g
1 End stops 10 mm 0.394 in 10.7 mm 0.421 in	Beige ■	BAM2 BAH24	1SNA296351R0000 1SNA168355R1300	50 50	12.00 12.00
2 End sections 1 mm 0.039 in	Beige ■	FEHD2	1SNA168949R1700	20	2.00
3 Jumper bars 2 poles 32 A (IEC) 3 poles 32 A (IEC) 4 poles 32 A (IEC) 5 poles 32 A (IEC) 10 poles 32 A (IEC)		BJS61-2 BJS61-3 BJS61-4 BJS61-5 BJS61-10	1SNA168481R2300 1SNA168482R2400 1SNA168483R2500 1SNA168484R2600 1SNA168485R2700	10 10 10 10 10	1.80 1.80 1.80 1.80 2.00
4 Test plugs DIA 2 mm 0.079 in	Black ■	FC2	1SNA007865R2600	100	2.00
5 Fastening kits Screw M2.5x5 for jumper bar BJH Washer for screw VSJ		VSJ6 RDJ6	1SNA167735R2700 1SNA173241R0600	1 1000	0.10
6 Terminal block markers Blank card	White ■	RC610	1SNA233000R0100	10	7.50

HD2.5/6.3.GG.1.2GG Quick connect terminal blocks

Feed-through - 6 mm 0.236 in spacing



2.5 mm²



HD2.5/6.3.GG.1.2GG

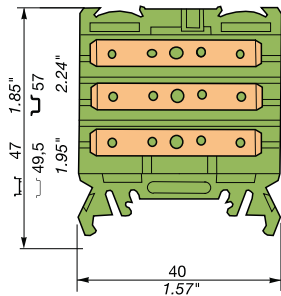

6 mm 0.236 in spacing

Description

- 3 circuits: 1 circuit with 2 longitudinal tabs for quick-connect 6.3 x 0.8 mm 0.248 x 0.031 in, possibility of testing and transverse connection and 2 circuit with 2 longitudinal tabs for quick-connect 6.3 x 0.8 mm 0.248 x 0.031 in,
- Use of jumper bars requires to cut out the precut partition.

Ordering details

Description	Color	Type	Part Numbers	Pkg qty	Weight (1 pce) g
6 tabs 3 circuits	Green ■	HD2.5/6.3.GG.1.2GG	1SNA199025R1400	50	11.00

Main technical data

Connecting capacity	NF C	DIN	NF F 61-017	Mounting instructions
1 conductor per clamp Quick-connect: 6.3 x 0.8 mm	0.34 ... 2.5 mm ²			Rail Type 2, TH 35-7.5, TH 35-15
Rated voltage	V AC (Cat. C) 250 V V DC (Cat. C) 250 V	(Cat. C) 250 V (Cat. C) 300 V		
Rated current	25 A			
Rated cross section	2.5 mm ²			

CE	RoHS	EAC									
----	------	-----	--	--	--	--	--	--	--	--	--

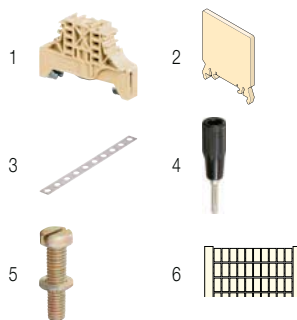

Accessories

Description	Color	Type	Part Numbers	Pkg qty	Weight (1 pce) g
1 End stops 10 mm 0.394 in	Beige ■	BAM2	1SNA296351R0000	50	12.00
10.7 mm 0.421 in		BAH24	1SNA168355R1300	50	12.00
2 End sections 1 mm 0.039 in	Beige ■	FEHD2	1SNA168949R1700	20	2.00
3 Jumper bars 2 poles 32 A (IEC)		BJS61-2	1SNA168481R2300	10	1.80
3 poles 32 A (IEC)		BJS61-3	1SNA168482R2400	10	1.80
4 poles 32 A (IEC)		BJS61-4	1SNA168483R2500	10	1.80
5 poles 32 A (IEC)		BJS61-5	1SNA168484R2600	10	1.80
10 poles 32 A (IEC)		BJS61-10	1SNA168485R2700	10	2.00
4 Test plugs DIA 2 mm 0.079 in	Black ■	FC2	1SNA007865R2600	100	2.00
5 Fastening kits Screw M2.5X5 for jumper bar BJH		VSJ6	1SNA167735R2700	1	
Washer for screw VSJ		RDJ6	1SNA173241R0600	1000	0.10
6 Terminal block markers Blank card	White ■	RC610	1SNA233000R0100	10	7.50

1SNC167060S0201

HD2.5/6.3.2G.2G.1 Quick connect terminal blocks

Feed-through - 6 mm 0.236 in spacing



Description

- Connection by 4 longitudinal tabs for quick-connect 6.3 x 0.8 mm 0.248 x 0.031 in,
- Possibility of testing and transverse connection,
- Use of jumper bars requires to cut out the precut partition.



HD2.5/6.3.2G.2G.1

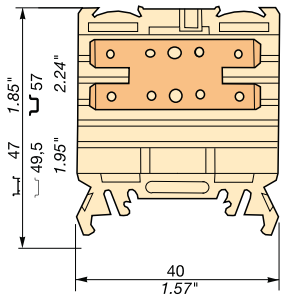

6 mm 0.236 in spacing

Ordering details

Description	Color	Type	Part Numbers	Pkg qty	Weight (1 pce) g
4 tabs 1 circuit	Beige <input type="checkbox"/>	HD2.5/6.3.2G.2G.1	1SNA190305R0500	50	10.00

Main technical data

Connecting capacity	NF C	DIN	NF F 61-017	Rail	Mounting instructions
1 conductor per clamp Quick-connect: 6.3 x 0.8 mm	0.34 ... 2.5 mm ²				Type 2, TH 35-7.5, TH 35-15
Rated voltage	V AC (Cat. C) 250 V	(Cat. C) 250 V			
	V DC (Cat. C) 250 V	(Cat. C) 300 V			
Rated current	25 A				
Rated cross section	2.5 mm ²				

--	--	--	--	--	--	--	--	--	--	--

Accessories

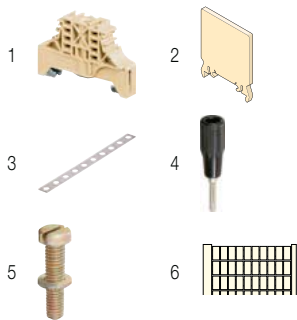

Description	Color	Type	Part Numbers	Pkg qty	Weight (1 pce) g
1 End stops 10 mm 0.394 in	Beige <input type="checkbox"/>	BAM2	1SNA296351R0000	50	12.00
10.7 mm 0.421 in		BAH24	1SNA168355R1300	50	12.00
2 End sections 1 mm 0.039 in	Beige <input type="checkbox"/>	FEHD2	1SNA168949R1700	20	2.00
3 Jumper bars 2 poles 32 A (IEC)		BJS61-2	1SNA168481R2300	10	1.80
3 poles 32 A (IEC)		BJS61-3	1SNA168482R2400	10	1.80
4 poles 32 A (IEC)		BJS61-4	1SNA168483R2500	10	1.80
5 poles 32 A (IEC)		BJS61-5	1SNA168484R2600	10	1.80
10 poles 32 A (IEC)		BJS61-10	1SNA168485R2700	10	2.00
4 Test plugs DIA 2 mm 0.079 in	Black <input type="checkbox"/>	FC2	1SNA007865R2600	100	2.00
5 Fastening kits Screw M2.5x5 for jumper bar BJH		VSJ6	1SNA167735R2700	1	
Washer for screw VSJ		RDJ6	1SNA173241R0600	1000	0.10
6 Terminal block markers Blank card	White <input type="checkbox"/>	RC610	1SNA233000R0100	10	7.50

HD2.5/6.3.GH.2G.H Quick connect terminal blocks

Feed-through - 6 mm 0.236 in spacing



Description

– 2 circuits: 1 circuit with 1 longitudinal tabs for quick-connect 6.3 x 0.8 mm 0.248 x 0.031 in and 1 pin for soldered connection, and 1 circuit with 2 longitudinal tabs for quick-connect 6.3 x 0.8 mm 0.248 x 0.031 in and 1 pin for soldered connection.



HD2.5/6.3.GH.2G.H

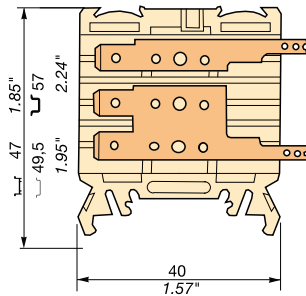

6 mm 0.236 in spacing

Ordering details

Description	Color	Type	Part Numbers	Pkg qty	Weight (1 pce) g
3 tabs and 2 pins	Beige <input type="checkbox"/>	HD2.5/6.3.GH.2G.H	1SNA199096R1400	50	11.00

Main technical data

Connecting capacity	NF C	DIN	NF F 61-017	Mounting instructions
1 conductor per clamp	Quick-connect: 0.34 ... 2.5 mm ² 6.3 x 0.8 mm			Rail Type 2, TH 35-7.5, TH 35-15
Rated voltage	V AC (Cat. C) 250 V V DC (Cat. C) 250 V	(Cat. C) 250 V (Cat. C) 300 V		
Rated current	25 A			
Rated cross section	2.5 mm ²			

--	--	--	--	--	--	--	--	--	--	--

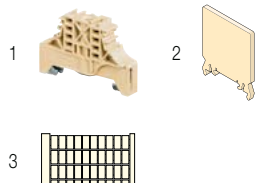

Accessories

Description	Color	Type	Part Numbers	Pkg qty	Weight (1 pce) g
1 End stops	Beige <input type="checkbox"/>	BAM2	1SNA296351R0000	50	12.00
		BAH24	1SNA168355R1300	50	12.00
2 End sections	Beige <input type="checkbox"/>	FEHD2	1SNA168949R1700	20	2.00
3 Terminal block markers	White <input type="checkbox"/>	RC610	1SNA233000R0100	10	7.50

5

1SNC167045S0201

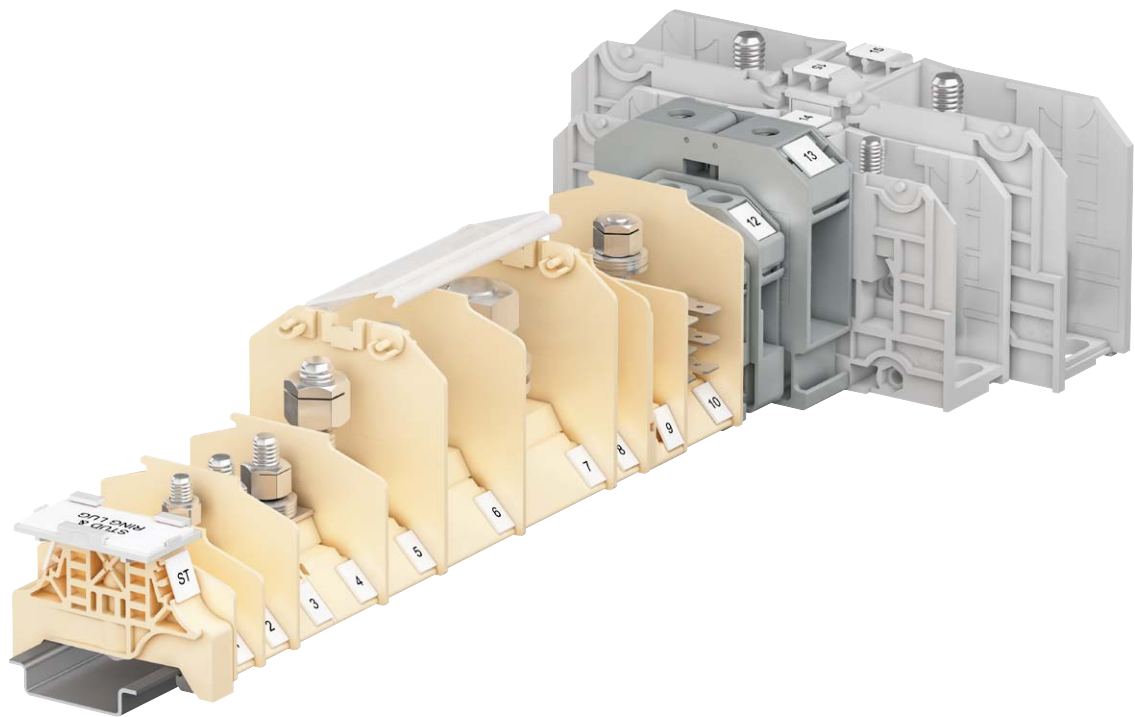

Railway applications, terminal blocks

Stud technology



Technologies presentation	170
Overview	172

1 stud

4 mm ²	HD4/9.F4	M4 stud with self locking nut + spring washers	176
	HD4/9.F4.2	M4 stud with nut	177
	HD4/10.F4.19	M4 stud with self locking nut + TREP washers	178
10 mm ²	HD10/12.F5.3	M5 stud with self locking nut + spring washers	179
	HD10/12.F5	M5 stud with self locking nut + TREP washers	180
	HD10/12.F5.1	M5 stud with 2 nuts + spring washers	181
	HD10/12.F5.2	M5 stud with 2 brass nuts + spring washers	181
35 mm ²	HD35/16.F6.19	M6 stud with self locking nut + TREP washers	182
	HD35/16.F6.19.1	M6 stud with 2 nuts + spring washers	183
70 mm ²	HD70/22.F8.31	M8 stud with self locking nut + TREP washers	184
	HD70/22.F8.31.1	M8 stud with 2 nuts + spring washers	185
	HD70/22.F8.31.2	M8 stud with 2 brass nuts + spring washers	185
120 mm ²	HD120/30.F10.31	M10 stud with self locking nut + TREP washers	186
	HD120/30.F10.31.1	M10 stud with 2 nuts + spring washers	187
185 mm ²	HD185/36.F12.31.1	M12 stud with 2 nuts + spring washers	188

2 studs for TH35 & type 2 rails mounting

4 mm ²	HD4/9.FF4	M4 studs with self locking nut + spring washers	189
6 mm ²	HD6/13.FF4	M4 studs with self locking nut + spring washers	190
10 mm ²	HD10/12.FF5	M5 studs with self locking nut + TREP washers	191
16 mm ²	HD16/14.FF5.21.3	M5 studs with self locking nut + spring washers	192
	HD16/14.FF5.20.3	M5 studs with self locking nut + spring washers	193
	HD16/14.FF5.21	M5 studs with self locking nut + TREP washers	194
	HD16/14.FF5.20	M5 studs with self locking nut + TREP washers	195

2 studs for TH35 & base mounting

35 mm ² / 1 AWG	D35/27.FF	M6 studs with 2 nuts + spring washers	196
70 mm ² / 000 AWG	D70/32.FF	M8 studs with 2 nuts + spring washers	197
120 mm ² / 300 Kcmil	D120/42.FF	M10 studs with 2 nuts + spring washers	198
185 mm ² / 500 Kcmil	D185/55.FF	M12 studs with 2 nuts + spring washers	199
300 mm ² / 1000 Kcmil	D300/55.FF	M16 studs with 2 nuts + spring washers	200

2 studs with captive nuts

2.5 mm ² / 14 AWG	RGW2.5-V0	M3 studs feed-through with captive nuts	201
6 mm ² / 10 AWG	RGW6-V0	M4 studs feed-through with captive nuts	202
25 mm ² / 4 AWG	RGW25-M5-V0	M5 studs feed-through with captive nuts	203
25 mm ² / 4 AWG	RGW25-M6-V0	M6 studs feed-through with captive nuts	204

Railway applications, terminal blocks

Stud technology

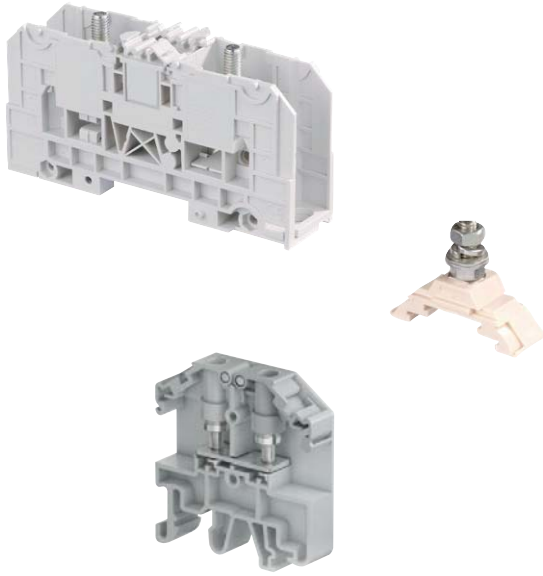

The “Pull-out proof” connection for rolling stock

The stud technology allows all power distribution configurations and improves wiring secureness thanks to “Pull-out proof” connection (stud+lug).

The HD terminal blocks provides a large scope of 1 and 2 studs configurations with different types of washers and nuts (Onduflex®, Trep®, Grover®).

The D type power blocks provide an alternative with specific locking foot and rotative covers.

The RGW terminal blocks offer a combination of fast and secured wiring, with captive nuts in a pivoting wing.



Reliable in harsh conditions

Continuous operation guaranteed for rolling stock

- Environmental tests: aging, corrosion, flammability, toxicity (I2F2, V0, HL3 R22)
- Mechanical tests: vibration and shock.



Safety and protection

Secured wiring

- Captive wire connection: stud + ring lug
- Anti-vibration and anti-loosening equipments: self locking nuts, spring washers.

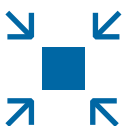

More control in smaller space

High density wiring with compact design

- 2 studs version: up to 4 conductors per block
- Compact 1 stud version for 2 conductors.

Features

HD / D type

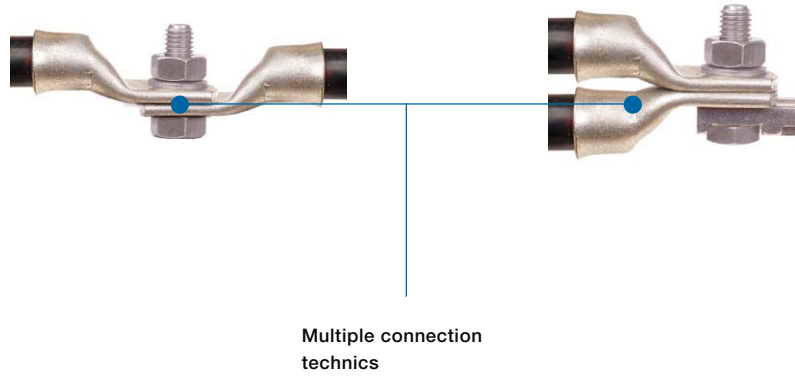

RGW type

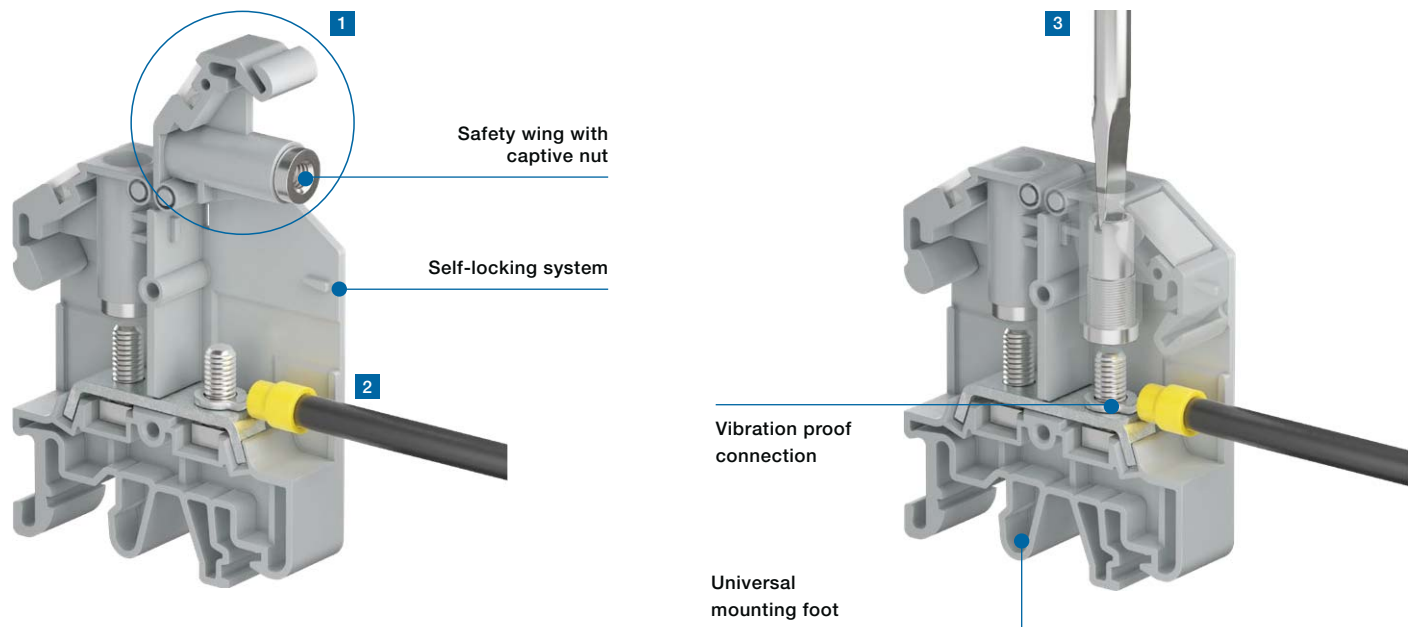

Easy 3 step wiring :

- 1 Open the safety wing -
- 2 Hook the wire on the stud and close the wing -
- 3 Screw down the nut

Railway applications, terminal blocks

Stud technology

Range overview up to 300 mm² / 1 000 Kcmil

HD type

From 4 mm² (M4)
to 185 mm² (M12)

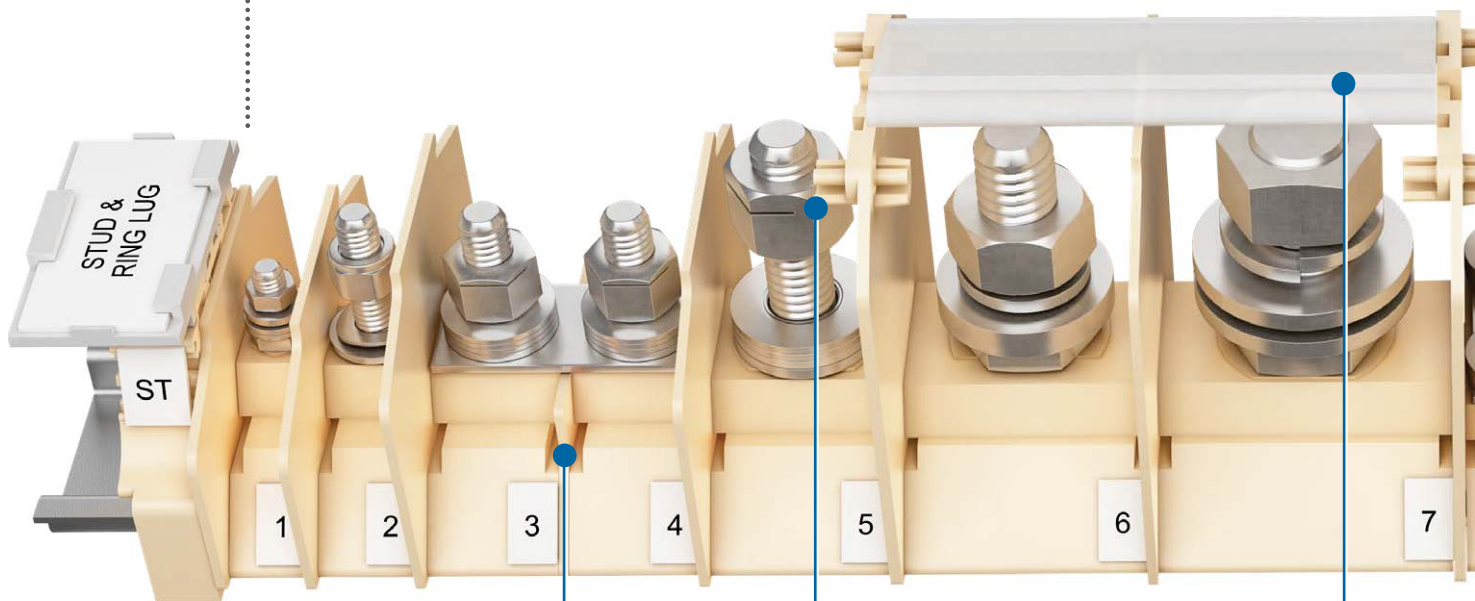

Spacers
Provide sufficient space between neighboring terminal blocks

Rotative cover
Protects the metallic parts

Anti-loosening equipments
Self-locking nut, plastic elastic washer or conical spring washers maintaining a constant pressure on the contact

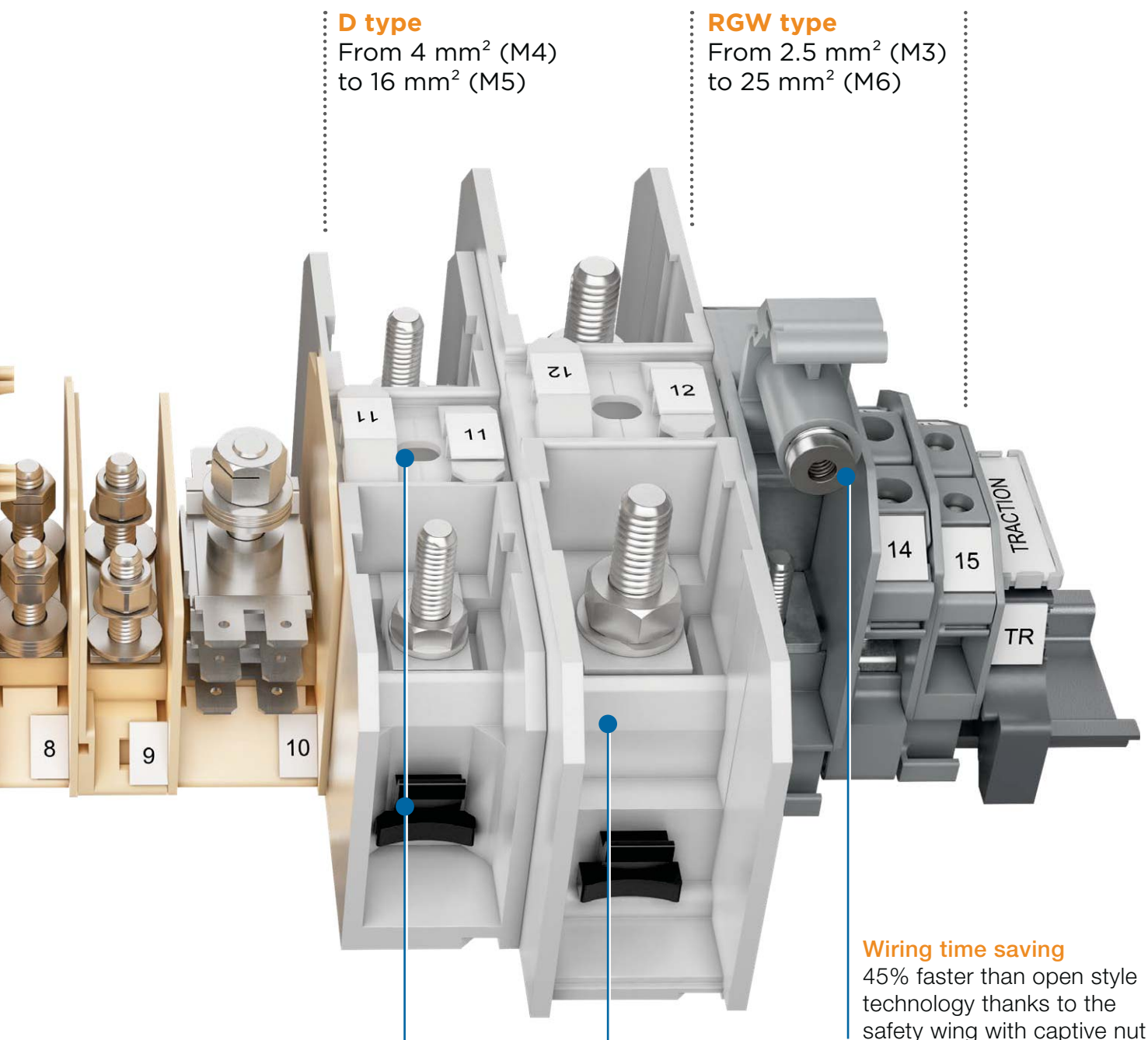

D type

From 4 mm² (M4)
to 16 mm² (M5)

RGW type

From 2.5 mm² (M3)
to 25 mm² (M6)

Wiring time saving

45% faster than open style technology thanks to the safety wing with captive nut

Easy locking / unlocking on the rail

Locking: single push on side foot
Unlocking: quarter-turn on the center

Adaptable protective cover

Removable and rotating for easier wiring





HD type - 1 Stud for TH35 & type 2 rails mounting

Section							
4 mm ²	M4	HD4/9.F4 HD4/9.F4.2 HD4/10.F4.19					
10 mm ²	M5		HD10/12.F5 HD10/12.F5.1...5.2 HD10/12.F5.3				
35 mm ²	M6			HD35/16.F6.19 HD35/16.F6.19.1			
70 mm ²	M8				HD70/22.F8.31 HD70/22.F8.31.1 HD70/22.F8.31.2		
120 mm ²						HD120/30.F10.31 HD120/30.F10.31.1	
185 mm ²							HD185/36.F12.31.1



HD type - 2 Studs for TH35 & type 2 rails mounting

Section								
4 mm ²	M4	HD4/9.FF4						
6 mm ²	M4		HD6/13.FF4					
10 mm ²	M5			HD10/12.FF5				
16 mm ²	M5				HD16/14.FF5.21	HD16/14.FF5.21.3	HD16/14.FF5.20.3	HD16/14.FF5.20

Clamp -
 Channels for jumpering or testing -
 Test socket -
 Blown-fuse indicator



D type - 2 Studs for TH35

Section						
35 mm ²	M6	D35/27.FF				
70 mm ²	M8		D70/32.FF			
120 mm ²	M10			D120/42.FF		
185 mm ²	M12				D185/55.FF	
300 mm ²	M16					D300/55.FF

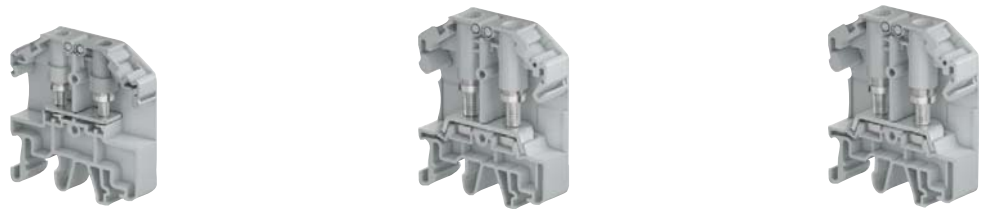

RGW type - 2 Studs with captive nuts for TH35

Section				
2.5 mm ²	M3	RGW2.5-V0		
6 mm ²	M4		RGW6-V0	
25 mm ²	M5			RGW25-M5-V0
	M6			RGW25-M6-V0

HD4/9.F4 stud terminal blocks

Feed-through - 9.5 mm 0.374 in spacing

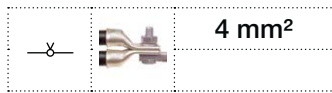

Description

- 1 stud terminal M4 x 11.5 mm 0.453 in,
- Equipment: self locking nut + spring washer + washer.

Ordering details

Description	Color	Type	Part Numbers	Pkg qty	Weight (1 pce)
1 stud M4	Beige <input type="checkbox"/>	HD4/9.F4	1SNA295391R2000	100	6.00

Main technical data

Connecting capacity	NF C	DIN	NF F 61-017
Wire size	Lug (NF C 20-130) Lug (DIN 46235 / 46234) Quick-connect: 6.3 x 0.8 mm	0.5 ... 4 mm ² 0.5 ... 4 mm ²	
Rated voltage	V AC V DC	(Cat. C) 500 V (Cat. C) 500 V	
Rated current		32 A	
Rated cross section		4 mm ²	

Mounting instructions

Rail	Diagram	Notes
		Type 2, TH 35-7.5, TH 35-15
Tool		Wrench Ø 7 mm Ø 0.276 in
Torque		1.2 N.m 10.6 lb.in



1SNC167103V0014

HD4/9.F4

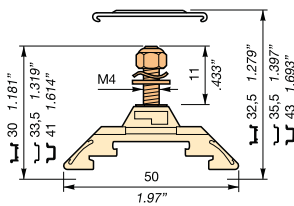

9.5 mm 0.374 in spacing

--	--	--	--	--	--	--	--	--	--

The use of a jumper bar requires to use a spacer instead of a circuit separator.

6

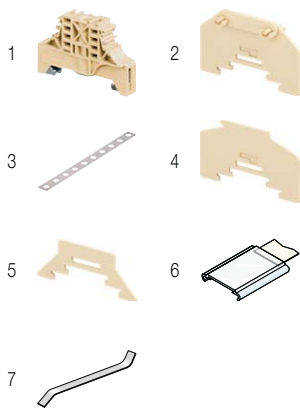

Accessories

Description	Color	Type	Part Numbers	Pkg qty	Weight (1 pce)
1 End stops	Beige <input type="checkbox"/>	BAM2	1SNA296351R0000	50	12.00
		BAH21	1SNA167489R2200	50	8.00
2 End sections	Beige <input type="checkbox"/>	FJHD32	1SNA295431R1000	25	4.00
3 Jumper bars		BJH105	1SNA163503R2400	10	197.00
4 Circuit separators	Beige <input type="checkbox"/>	SCHD1	1SNA295428R2500	25	2.00
5 Spacers	Beige <input type="checkbox"/>	INH1	1SNA295427R1400	25	2.00
6 Protecting covers	Transparent <input checked="" type="checkbox"/>	CPM	1SNA187312R1400	1	25.00
	Beige <input type="checkbox"/>	CPM	1SNA197312R1600	10	25.00
7 Terminal block markers	White <input type="checkbox"/>	RTC	1SNA163156R2700	1	10.00
		PEFH	1SNA163497R1600	10	10.00
		RPED	1SNA163518R2200	1	12.00
	White <input type="checkbox"/>	RC610	1SNA233000R0100	10	7.50

HD4/9.F4.2 stud terminal blocks

Feed-through - 9.5 mm 0.374 in spacing



Description

- 1 stud terminal M4 x 11.5 mm 0.453 in,
- Equipment: 1 bottom nut + 2 washers + 1 spring washer + 1 top nut.

Ordering details

Description	Color	Type	Part Numbers	Pkg qty	Weight (1 pce) g	
1 stud M4	Brass equipment	Yellow <input type="checkbox"/>	HD4/9.F4.2	1SNA205392R0700	100	6.00
		Beige <input type="checkbox"/>	HD4/9.F4.2	1SNA295392R2100	100	6.00

Main technical data

Connecting capacity	NF C	DIN	NF F 61-017	Rail	Tool	Torque
Wire size	Lug (NF C 20-130) Lug (DIN 46235 / 46234) Quick-connect: 6.3 x 0.8 mm	0.5 ... 4 mm²	0.5 ... 4 mm²	Type 2, TH 35-7.5, TH 35-15	Wrench Ø 7 mm Ø 0.276 in	1.2 N.m 10.6 lb.in
Rated voltage	V AC V DC	(Cat. C) 500 V (Cat. C) 500 V				
Rated current		32 A				
Rated cross section		4 mm²				

Mounting instructions



1SNC167106W0014

HD4/9.F4.2

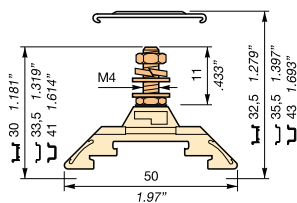

9.5 mm 0.374 in spacing

<input type="checkbox"/> CE	<input type="checkbox"/> RoHS	<input type="checkbox"/> EAC																		
-----------------------------	-------------------------------	------------------------------	--	--	--	--	--	--	--	--	--	--	--	--	--	--	--	--	--	--

The use of a jumper bar requires to use a spacer instead of a circuit separator.

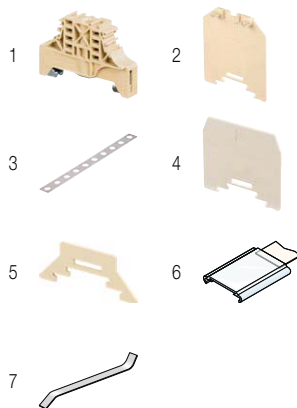

Accessories

Description	Color	Type	Part Numbers	Pkg qty	Weight (1 pce) g
1 End stops	10 mm 0.394 in	Beige <input type="checkbox"/>	BAM2	50	12.00
	7.1 mm 0.28 in	Beige <input type="checkbox"/>	BAH21	50	8.00
2 End sections	1.5 mm 0.059 in	Yellow <input type="checkbox"/>	FJHD32	25	
		Beige <input type="checkbox"/>	FJHD32	25	4.00
3 Jumper bars	10 poles	Yellow <input type="checkbox"/>	BJH105	10	197.00
4 Circuit separators	1.2 mm 0.047 in	Yellow <input type="checkbox"/>	SCHD1	25	2.00
		Beige <input type="checkbox"/>	SCHD1	25	2.00
5 Spacers	1.2 mm 0.047 in	Yellow <input type="checkbox"/>	INH1	25	2.00
		Beige <input type="checkbox"/>	INH1	25	2.00
6 Protecting covers	Length 500 mm 19.70 in	Transparent <input checked="" type="checkbox"/>	CPM	1	25.00
		Beige <input type="checkbox"/>	CPM	10	25.00
		White <input type="checkbox"/>	CPM	10	25.00
7 Terminal block markers	Blank strip label for CPM	White <input type="checkbox"/>	RTC	1	10.00
	Label holder		PEFH	10	
	Blank label for PEFH		RPED	1	12.00
	Blank card	White <input type="checkbox"/>	RC610	10	7.50

HD4/10.F4.19 stud terminal blocks

Feed-through - 10.5 mm 0.413 in spacing

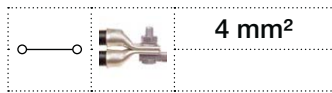

HD4/10.F4.19

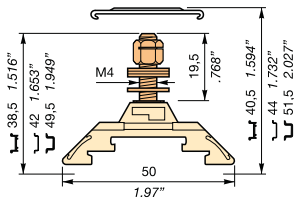

10.5 mm 0.413 in spacing

Description

- 1 stud terminal M4 x 19.5 mm 0.768 in,
- Equipment: H 130 self locking nut + TREP 3L washer + washer.

Ordering details

Description	Color	Type	Part Numbers	Pkg qty	Weight (1 pce)
1 stud M4	Beige <input type="checkbox"/>	HD4/10.F4.19	1SNA295298R0300	50	11.00

Main technical data

Connecting capacity	NF C	DIN	NF F 61-017	Mounting instructions	
Wire size	Lug (NF C 20-130) Lug (DIN 46235 / 46234) Quick-connect: 6.3 x 0.8 mm	0.5 ... 4 mm ² 0.5 ... 4 mm ²		Rail	Type 2, TH 35-7.5, TH 35-15
Rated voltage	V AC V DC	(Cat. C) 500 V (Cat. C) 500 V		Tool	Wrench Ø 7 mm Ø 0.276 in
Rated current		32 A		Torque	1.5 N.m 13.3 lb.in
Rated cross section		4 mm ²			

<input type="checkbox"/> CE	<input type="checkbox"/> RoHS	<input type="checkbox"/> EAC							
-----------------------------	-------------------------------	------------------------------	--	--	--	--	--	--	--

Accessories

Description	Color	Type	Part Numbers	Pkg qty	Weight (1 pce)
1 End stops	Beige <input type="checkbox"/>	BAM2	1SNA296351R0000	50	12.00
2 End sections	Beige <input type="checkbox"/>	BAH22	1SNA164655R0400	50	10.00
3 Circuit separators	Beige <input type="checkbox"/>	FJHD40	1SNA295424R1100	25	4.00
4 Spacers	Beige <input type="checkbox"/>	FJDHD	1SNA295426R1300	25	4.00
5 Protecting covers	Transparent <input type="checkbox"/>	SCHD2	1SNA295429R2600	25	2.00
6 Terminal block markers	Beige <input type="checkbox"/>	INH1	1SNA295427R1400	25	2.00
	White <input type="checkbox"/>	CPM	1SNA187312R1400	1	25.00
	White <input type="checkbox"/>	CPM	1SNA197312R1600	10	25.00
	White <input type="checkbox"/>	RTC	1SNA163156R2700	1	10.00
	White <input type="checkbox"/>	PEFH	1SNA163497R1600	10	10.00
	White <input type="checkbox"/>	RPED	1SNA163518R2200	1	12.00
	White <input type="checkbox"/>	RC610	1SNA233000R0100	10	7.50

HD10/12.F5.3 stud terminal blocks

Feed-through - 12 mm 0.473 in spacing



HD10/12.F5.3

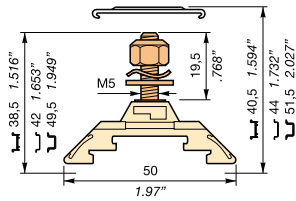

12 mm 0.473 in spacing

Description

- 1 stud terminal M5 x 19.5 mm 0.768 in,
- Equipment: self locking nut + spring washer + washer,
- NF F 61-017 designation: BD13.2-1F5 (1SNA295011R1600 + SCHD2).

Ordering details

Description	Color	Type	Part Numbers	Pkg qty	Weight (1 pce) g
1 stud M5	Beige <input type="checkbox"/>	HD10/12.F5.3	1SNA295011R1600	50	12.00

Main technical data

Connecting capacity	NF C	DIN	NF F 61-017	Rail	Tool	Torque
Wire size	Lug (NF C 20-130) Lug (DIN 46235 / 46234) Quick-connect: 6.3 x 0.8 mm	0.5 ... 10 mm ² 0.5 ... 10 mm ²		Type 2, TH 35-7.5, TH 35-15	Wrench Ø 8 mm Ø 0.315 in	2.5 N.m 22.1 lb.in
Rated voltage	V AC V DC	(Cat. C) 750 V (Cat. C) 750 V	750 V 750 V			
Rated current		57 A	51 A			
Rated cross section		10 mm ²				

Mounting instructions

CE	RoHS	EAC																	
----	------	-----	--	--	--	--	--	--	--	--	--	--	--	--	--	--	--	--	--

The use of a jumper bar requires to use a spacer instead of a circuit separator.

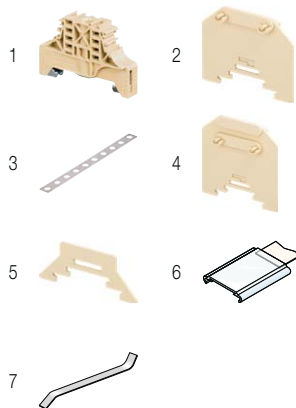

Accessories

Description	Color	Type	Part Numbers	Pkg qty	Weight (1 pce) g
1 End stops	Beige <input type="checkbox"/>	BAM2	1SNA296351R0000	50	12.00
		BAH22	1SNA164655R0400	50	10.00
2 End sections	Beige <input type="checkbox"/>	FJHD40	1SNA295424R1100	25	4.00
3 Jumper bars		BJH131-10	1SNA163468R0000	10	59.00
4 Circuit separators	Beige <input type="checkbox"/>	FJDHD	1SNA295426R1300	25	4.00
		SCHD2	1SNA295429R2600	25	2.00
5 Spacers	Beige <input type="checkbox"/>	INH1	1SNA295427R1400	25	2.00
6 Protecting covers	Transparent <input checked="" type="checkbox"/>	CPM	1SNA187312R1400	1	25.00
	Beige <input type="checkbox"/>	CPM	1SNA197312R1600	10	25.00
	White <input type="checkbox"/>	RTC	1SNA163156R2700	1	10.00
7 Terminal block markers		PEFH	1SNA163497R1600	10	
		RPED	1SNA163518R2200	1	12.00
	White <input type="checkbox"/>	RC610	1SNA233000R0100	10	7.50

HD10/12.F5 stud terminal blocks

Feed-through - 12 mm 0.473 in spacing

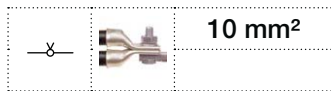

1SNC16702F0014

HD10/12.F5

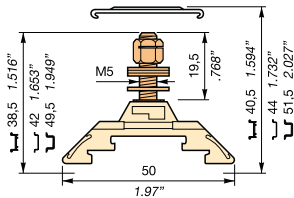

12 mm 0.473 in spacing

Description

- 1 stud terminal M5 x 19.5 mm 0.768 in,
- Equipment: H 130 self locking nut + TREP 3L washer + washer.

Ordering details

Description	Color	Type	Part Numbers	Pkg qty	Weight (1 pce)
1 stud M5	Beige <input type="checkbox"/>	HD10/12.F5	1SNA295394R2300	50	11.00

Main technical data

Connecting capacity	NF C	DIN	NF F 61-017	Mounting instructions	
Wire size	Lug (NF C 20-130) Lug (DIN 46235 / 46234) Quick-connect: 6.3 x 0.8 mm	0.5 ... 10 mm ² 0.5 ... 10 mm ²		Rail	Type 2, TH 35-7.5, TH 35-15
Rated voltage	V AC V DC	(Cat. C) 750 V (Cat. C) 750 V		Tool	Wrench Ø 8 mm Ø 0.315 in
Rated current		57 A		Torque	2.5 N.m 22.1 lb.in
Rated cross section		10 mm ²			

--	--	--	--	--	--	--	--	--	--	--

The use of a jumper bar requires to use a spacer instead of a circuit separator.

Accessories

Description	Color	Type	Part Numbers	Pkg qty	Weight (1 pce)
1 End stops	Beige <input type="checkbox"/>	BAM2	1SNA296351R0000	50	12.00
2 End sections	Beige <input type="checkbox"/>	BAH22	1SNA164655R0400	50	10.00
3 Jumper bars		BJH131-10	1SNA163468R0000	10	59.00
4 Circuit separators	Beige <input type="checkbox"/>	FJDHD	1SNA295426R1300	25	4.00
5 Spacers	Beige <input type="checkbox"/>	SCHD2	1SNA295429R2600	25	2.00
6 Protecting covers	Transparent <input checked="" type="checkbox"/>	INHD1	1SNA295427R1400	25	2.00
7 Terminal block markers	Beige <input type="checkbox"/>	CPM	1SNA187312R1400	1	25.00
	White <input type="checkbox"/>	CPM	1SNA197312R1600	10	25.00
		RTC	1SNA163156R2700	1	10.00
		PEFH	1SNA163497R1600	10	
		RPED	1SNA163518R2200	1	12.00
	White <input type="checkbox"/>	RC610	1SNA233000R0100	10	7.50

HD10/12.F5 stud terminal blocks

Feed-through - 12 mm 0.473 in spacing

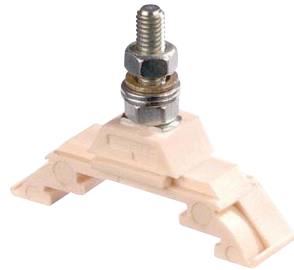

HD10/12.F5

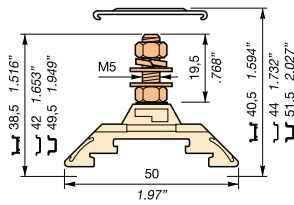

12 mm 0.473 in spacing

Description

- 1 stud terminal M5 x 19.5 mm 0.768 in,
- Equipment: 1 bottom nut + 2 washers + 1 spring washer + 1 top nut.

Ordering details

Description	Color	Type	Part Numbers	Pkg qty	Weight (1 pce) g	
1 stud M5	Steel equipment	Beige <input type="checkbox"/>	HD10/12.F5.1	1SNA295395R2400	50	11.00
	Brass equipment	Beige <input type="checkbox"/>	HD10/12.F5.2	1SNA295396R2500	50	11.00
		Yellow <input type="checkbox"/>	HD10/12.F5.2	1SNA205396R0300	50	11.00

Main technical data

Connecting capacity	NF C	DIN	NF F 61-017	Rail	Tool	Torque
Wire size	Lug (NF C 20-130) Lug (DIN 46235 / 46234) Quick-connect: 6.3 x 0.8 mm	0.5 ... 10 mm ²	0.5 ... 10 mm ²	Type 2, TH 35-7.5, TH 35-15	Wrench Ø 8 mm Ø 0.315 in	2 N.m 17.7 lb.in
Rated voltage	V AC V DC	(Cat. C) 750 V (Cat. C) 750 V				
Rated current		57 A				
Rated cross section		10 mm ²				

Mounting instructions

--	--	--	--	--	--	--

The use of a jumper bar requires to use a spacer instead of a circuit separator.

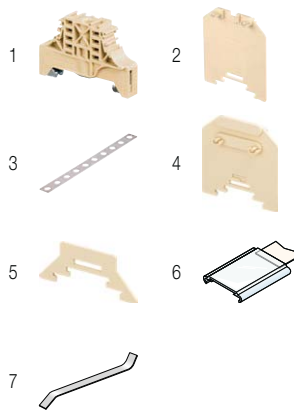

Accessories

Description	Color	Type	Part Numbers	Pkg qty	Weight (1 pce) g
1 End stops	Beige <input type="checkbox"/>	BAM2	1SNA296351R0000	50	12.00
	Beige <input type="checkbox"/>	BAH22	1SNA164655R0400	50	10.00
2 End sections	Yellow <input type="checkbox"/>	FJHD40	1SNA205424R2700	25	4.00
	Beige <input type="checkbox"/>	FJHD40	1SNA295424R1100	25	59.00
3 Jumper bars		BJH131-10	1SNA163468R0000	10	4.00
4 Circuit separators	Beige <input type="checkbox"/>	FJDHD	1SNA295426R1300	25	2.00
	Yellow <input type="checkbox"/>	SCHD2	1SNA205429R0400	25	2.00
5 Spacers	Beige <input type="checkbox"/>	SCHD2	1SNA295429R2600	25	2.00
	Yellow <input type="checkbox"/>	INH1	1SNA205427R2200	25	2.00
6 Protecting covers	Beige <input type="checkbox"/>	INH1	1SNA295427R1400	25	25.00
	Transparent <input type="checkbox"/>	CPM	1SNA187312R1400	1	25.00
7 Terminal block markers	Beige <input type="checkbox"/>	CPM	1SNA197312R1600	10	10.00
	White <input type="checkbox"/>	RTC	1SNA163156R2700	1	12.00
		PEFH	1SNA163497R1600	1	7.50
		RPED	1SNA163518R2200	1	
		White <input type="checkbox"/>	RC610	1SNA233000R0100	10

HD35/16.F6.19 stud terminal blocks

Feed-through - 16 mm 0.63 in spacing



HD35/16.F6.19

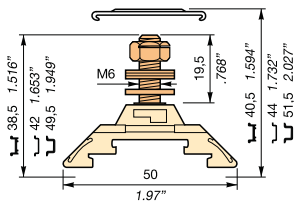

16 mm 0.63 in spacing

Description

- 1 stud terminal M6 x 19.5 mm 0.768 in,
- Equipment: H 130 self locking nut + TREP 3L washer + washer,
- NF F 61-017 designation: BD17.2-1F6 (1SNA295398R0700 + SCHD2).

Ordering details

Description	Color	Type	Part Numbers	Pkg qty	Weight (1 pce) g
1 stud M6	Beige <input type="checkbox"/>	HD35/16.F6.19	1SNA295398R0700	50	17.00

Main technical data

Connecting capacity	NF C	DIN	NF F 61-017
Wire size	Lug (NF C 20-130) Lug (DIN 46235 / 46234) Quick-connect: 6.3 x 0.8 mm	1.5 ... 35 mm² 2.5 ... 35 mm²	
Rated voltage	V AC V DC	(Cat. C) 750 V (Cat. C) 750 V	750 V 750 V
Rated current		125 A	125 A
Rated cross section		35 mm²	

Mounting instructions

Rail	Tool	Torque
Type 2, TH 35-7.5, TH 35-15		Wrench Ø 10 mm Ø 0.394 in
		5.3 N.m 46.9 lb.in

--	--	--

The use of a jumper bar requires to use a spacer instead of a circuit separator.

6

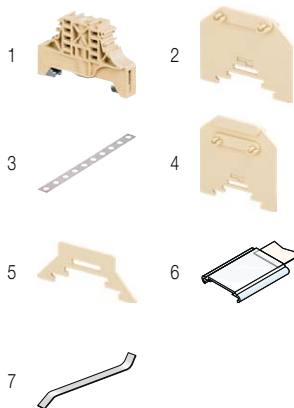

Accessories

Description	Color	Type	Part Numbers	Pkg qty	Weight (1 pce) g
1 End stops	Beige <input type="checkbox"/>	BAM2	1SNA296351R0000	50	12.00
2 End sections	Beige <input type="checkbox"/>	BAH22	1SNA164655R0400	50	10.00
3 Jumper bars	Beige <input type="checkbox"/>	FJHD40	1SNA295424R1100	25	4.00
4 Circuit separators	Beige <input type="checkbox"/>	BJH17	1SNA163475R2700	10	99.00
5 Spacers	Beige <input type="checkbox"/>	FJDHD	1SNA295426R1300	25	4.00
6 Protecting covers	Transparent <input checked="" type="checkbox"/>	SCHD2	1SNA295429R2600	25	2.00
	Beige <input type="checkbox"/>	INHD1	1SNA295427R1400	25	2.00
7 Terminal block markers	White <input checked="" type="checkbox"/>	CPM	1SNA187312R1400	1	25.00
	Beige <input type="checkbox"/>	RTC	1SNA197312R1600	10	25.00
	White <input type="checkbox"/>	PEFH	1SNA163156R2700	1	10.00
	White <input type="checkbox"/>	RPED	1SNA163497R1600	10	
	White <input type="checkbox"/>	RC610	1SNA163518R2200	1	12.00
	White <input type="checkbox"/>		1SNA233000R0100	10	7.50

HD35/16.F6.19.1 stud terminal blocks

Feed-through - 16 mm 0.63 in spacing

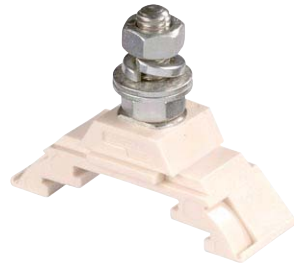

HD35/16.F6.19.1

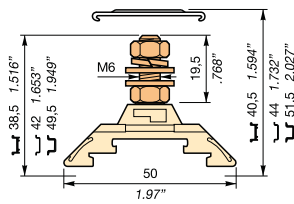

16 mm 0.63 in spacing

Description

- 1 stud terminal M6 x 19.5 mm 0.768 in,
- Equipment: 1 bottom nut + 2 washers + 1 spring washer + 1 top nut.

Ordering details

Description	Color	Type	Part Numbers	Pkg qty	Weight (1 pce) g
1 stud M6	Beige <input type="checkbox"/>	HD35/16.F6.19.1	1SNA295399R0000	50	17.00

Main technical data

Connecting capacity		NF C	DIN	NF F 61-017	Mounting instructions	
Wire size	Lug (NF C 20-130)	1.5 ... 35 mm ²			Rail	Type 2, TH 35-7.5, TH 35-15
	Lug (DIN 46235 / 46234)		2.5 ... 35 mm ²		Tool	Wrench Ø 10 mm Ø 0.394 in
	Quick-connect: 6.3 x 0.8 mm					
Rated voltage	V AC	(Cat. C) 750 V			Torque	3 N.m 26.6 lb.in
	V DC	(Cat. C) 750 V				
Rated current		125 A				
Rated cross section		35 mm ²				

--	--	--	--	--	--	--	--	--	--	--	--	--	--	--	--	--	--	--	--

The use of a jumper bar requires to use a spacer instead of a circuit separator.

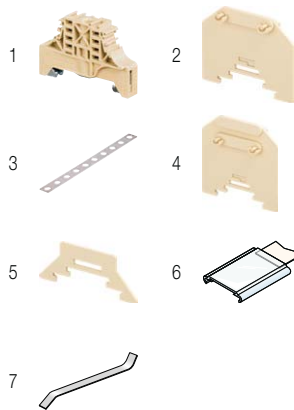

Accessories

Description	Color	Type	Part Numbers	Pkg qty	Weight (1 pce) g
1 End stops	Beige <input type="checkbox"/>		BAM2	1SNA296351R0000	50 12.00
			BAH22	1SNA164655R0400	50 10.00
2 End sections	Beige <input type="checkbox"/>		FJHD40	1SNA295424R1100	25 4.00
3 Jumper bars			BJH17	1SNA163475R2700	10 99.00
4 Circuit separators	Beige <input type="checkbox"/>		FJDHD	1SNA295426R1300	25 4.00
			SCHD2	1SNA295429R2600	25 2.00
5 Spacers	Beige <input type="checkbox"/>		INH1	1SNA295427R1400	25 2.00
6 Protecting covers	Transparent <input checked="" type="checkbox"/>		CPM	1SNA187312R1400	1 25.00
			CPM	1SNA197312R1600	10 25.00
			RTC	1SNA163156R2700	1 10.00
			PEFH	1SNA163497R1600	10 10.00
7 Terminal block markers	White <input type="checkbox"/>		RPED	1SNA163518R2200	1 12.00
			RC610	1SNA233000R0100	10 7.50
			Blank strip label for CPM		
			Label holder		
			Blank label for PEFH		
			Blank card		

HD70/22.F8 stud terminal blocks

Feed-through - 22 mm 0.866 in spacing



1SNC167111W0014

HD70/22.F8

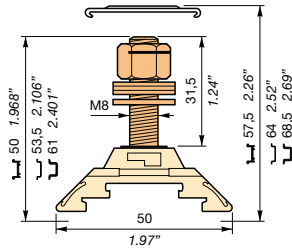

22 mm 0.866 in spacing

Description

- 1 stud terminal M8 x 31.5 mm 1.24 in,
- Equipment: H 130 self locking nut + TREP 3L washer + washer,
- NF F 61-017 designation: BD23.2-1F8 (1SNA295400R0600 + SCH8).

Ordering details

Description	Color	Type	Part Numbers	Pkg qty	Weight (1 pce) g
1 stud M8	Beige <input type="checkbox"/>	HD70/22.F8.31	1SNA295400R0600	50	39.00

Main technical data

Connecting capacity	NF C	DIN	NF F 61-017	Rail	Tool	Mounting instructions
Wire size	Lug (NF C 20-130) Lug (DIN 46235 / 46234) Quick-connect: 6.3 x 0.8 mm	1.5 ... 70 mm²	2.5 ... 50 mm²			Type 2, TH 35-7.5, TH 35-15 Wrench Ø 13 mm Ø 0.512 in
Rated voltage	V AC V DC	(Cat. C) 750 V (Cat. C) 750 V	750 V 750 V			
Rated current		192 A	188 A	Torque		13.4 N.m 118.6 lb.in
Rated cross section		70 mm²				

--	--	--	--	--	--	--

The use of a jumper bar requires to use a spacer instead of a circuit separator.

Accessories

Description	Color	Type	Part Numbers	Pkg qty	Weight (1 pce) g
1 End stops	Beige <input type="checkbox"/>	BAM2	1SNA296351R0000	50	12.00
2 End sections	Beige <input type="checkbox"/>	BAH24	1SNA168355R1300	50	12.00
3 Jumper bars		BJH23-10	1SNA163476R2000	10	185.00
4 Circuit separators	Beige <input type="checkbox"/>	SCH8	1SNA199412R1500	25	4.80
5 Spacers	Beige <input type="checkbox"/>	INH1	1SNA295427R1400	25	2.00
6 Protecting covers	Transparent <input checked="" type="checkbox"/>	CPM	1SNA187312R1400	1	25.00
	Beige <input type="checkbox"/>	CPM	1SNA197312R1600	10	25.00
7 Terminal block markers	White <input type="checkbox"/>	RTC	1SNA163156R2700	1	10.00
		PEFH	1SNA163497R1600	10	10.00
		RPED	1SNA163518R2200	1	12.00
	White <input type="checkbox"/>	RC610	1SNA233000R0100	10	7.50

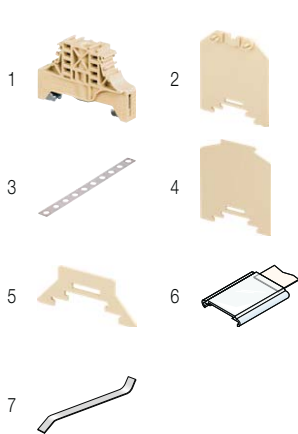

HD70/22.F8.31 stud terminal blocks

Feed-through - 22 mm 0.866 in spacing

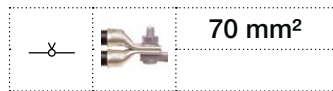

Description

- 1 stud terminal M8 x 31.5 mm 1.24 in,
- Equipment: 1 bottom nut + 2 washers + 1 spring washer + 1 top nut.

Ordering details

Description		Color	Type	Part Numbers	Pkg qty	Weight (1 pce) g
1 stud M8	Steel equipment	Beige <input type="checkbox"/>	HD70/22.F8.31.1	1SNA295401R2300	50	39.00
	Brass equipment	Beige <input type="checkbox"/>	HD70/22.F8.31.2	1SNA295402R2400	50	39.00

Main technical data

Connecting capacity	NF C	DIN	NF F 61-017	Rail	Tool	Torque
Wire size	Lug (NF C 20-130) Lug (DIN 46235 / 46234) Quick-connect: 6.3 x 0.8 mm	1.5 ... 70 mm ²	2.5 ... 50 mm ²	Type 2, TH 35-7.5, TH 35-15	Wrench Ø 13 mm Ø 0.512 in	6 N.m 53.1 lb.in
Rated voltage	V AC V DC	(Cat. C) 750 V (Cat. C) 750 V				
Rated current		192 A				
Rated cross section		70 mm ²				

Mounting instructions



1SNC167031F0014

HD70/22.F8.31

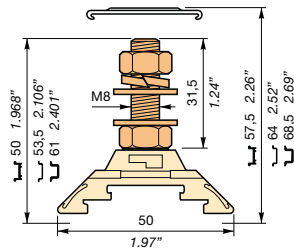

22 mm 0.866 in spacing

CE	RoHS	EAC																	
----	------	-----	--	--	--	--	--	--	--	--	--	--	--	--	--	--	--	--	--

The use of a jumper bar requires to use a spacer instead of a circuit separator.

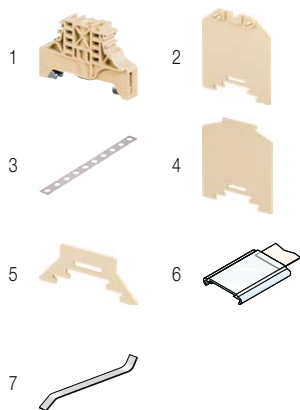

Accessories

Description		Color	Type	Part Numbers	Pkg qty	Weight (1 pce) g
1 End stops	10 mm 0.394 in	Beige <input type="checkbox"/>	BAM2	1SNA296351R0000	50	12.00
	10.7 mm 0.421 in		BAH24	1SNA168355R1300	50	12.00
2 End sections	1.5 mm 0.059 in	Beige <input type="checkbox"/>	FJH501	1SNA199411R1400	25	6.50
3 Jumper bars	10 poles		BJH23-10	1SNA163476R2000	10	185.00
4 Circuit separators	1.2 mm 0.047 in	Beige <input type="checkbox"/>	SCH8	1SNA199412R1500	25	4.80
5 Spacers	1.2 mm 0.047 in	Beige <input type="checkbox"/>	INH1	1SNA295427R1400	25	2.00
6 Protecting covers	Length 500 mm 19.70 in	Transparent <input checked="" type="checkbox"/>	CPM	1SNA187312R1400	1	25.00
		Beige <input type="checkbox"/>	CPM	1SNA197312R1600	10	25.00
7 Terminal block markers	Blank strip label for CPM	White <input type="checkbox"/>	RTC	1SNA163156R2700	1	10.00
	Label holder		PEFH	1SNA163497R1600	10	12.00
	Blank label for PEFH		RPED	1SNA163518R2200	1	12.00
	Blank card	White <input type="checkbox"/>	RC610	1SNA233000R0100	10	7.50

HD120/30.F10.31 stud terminal blocks

Feed-through - 30 mm 1.18 in spacing



1SNC167059/0014

HD120/30.F10.31

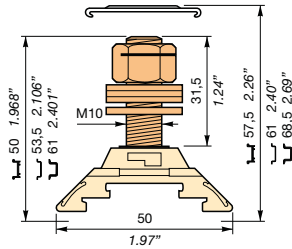

30 mm 1.18 in spacing

Description

- 1 stud terminal M10 x 31.5 mm 1.24 in,
- Equipment: H 130 self locking nut + TREP 3L washer + washer.

Ordering details

Description	Color	Type	Part Numbers	Pkg qty	Weight (1 pce)
1 stud M10	Beige <input type="checkbox"/>	HD120/30.F10.31	1SNA295448R0100	10	60.00

Main technical data

Connecting capacity	NF C	DIN	NF F 61-017	Rail	Tool	Mounting instructions
Wire size	Lug (NF C 20-130) Lug (DIN 46235 / 46234) Quick-connect: 6.3 x 0.8 mm	10 ... 120 mm² 6 ... 120 mm²				Type 2, TH 35-7.5, TH 35-15 Wrench Ø 16 mm Ø 0.63 in
Rated voltage	V AC V DC	(Cat. C) 750 V (Cat. C) 750 V			Torque	30 N.m 265.5 lb.in
Rated current		269 A				
Rated cross section		120 mm²				

--	--	--	--	--	--	--

The use of a jumper bar requires to use a spacer instead of a circuit separator.

Accessories

Description	Color	Type	Part Numbers	Pkg qty	Weight (1 pce)
1 End stops	Beige <input type="checkbox"/>	BAM2	1SNA296351R0000	50	12.00
2 End sections	Beige <input type="checkbox"/>	BAH24	1SNA168355R1300	50	12.00
3 Jumper bars		BJH311	1SNA163479R0300	10	233.00
4 Circuit separators	Beige <input type="checkbox"/>	SCH8	1SNA199412R1500	25	4.80
5 Spacers	Beige <input type="checkbox"/>	INH1	1SNA295427R1400	25	2.00
6 Protecting covers	Transparent <input checked="" type="checkbox"/>	CPM	1SNA187312R1400	1	25.00
	Beige <input type="checkbox"/>	CPM	1SNA197312R1600	10	25.00
7 Terminal block markers	White <input type="checkbox"/>	RTC	1SNA163156R2700	1	10.00
		PEFH	1SNA163497R1600	10	10.00
		RPED	1SNA163518R2200	1	12.00
	White <input type="checkbox"/>	RC610	1SNA233000R0100	10	7.50

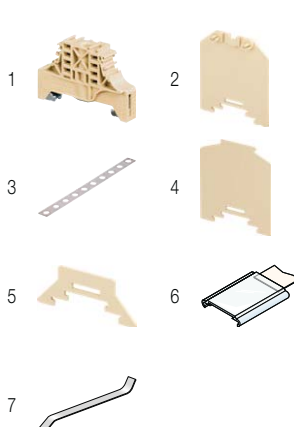

HD120/30.F10.31.1 stud terminal blocks

Feed-through - 30 mm 1.18 in spacing



120 mm²

Description

- 1 stud terminal M10 x 31.5 mm 1.24 in,
- Equipment: 1 bottom nut + 2 washers + 1 spring washer + 1 top nut.



1SNC167112V0014

HD120/30.F10.31.1

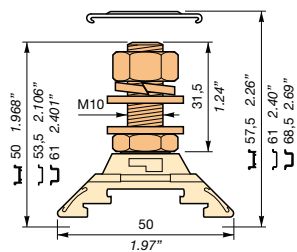

30 mm 1.18 in spacing

Ordering details

Description	Color	Type	Part Numbers	Pkg qty	Weight (1 pce) g
1 stud M10	Beige <input type="checkbox"/>	HD120/30.F10.31.1	1SNA295403R2500	10	60.00

Main technical data

Connecting capacity		NF C	DIN	NF F 61-017	Rail	Tool	Torque
Wire size	Lug (NF C 20-130)	10 ... 120 mm ²					Type 2, TH 35-7.5, TH 35-15 Wrench Ø 16 mm Ø 0.63 in
	Lug (DIN 46235 / 46234)	6 ... 120 mm ²					
	Quick-connect: 6.3 x 0.8 mm						
Rated voltage	V AC	(Cat. C) 750 V				10 N.m 88.5 lb.in	
	V DC	(Cat. C) 750 V					
Rated current		269 A					
Rated cross section		120 mm ²					

Mounting instructions

CE	RoHS	EAC
<input type="checkbox"/>	<input type="checkbox"/>	<input type="checkbox"/>

The use of a jumper bar requires to use a spacer instead of a circuit separator.

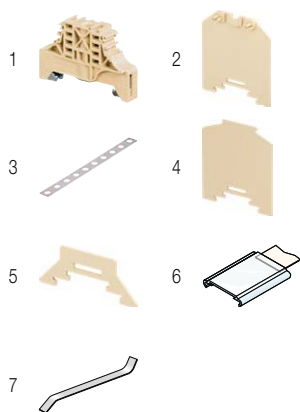

Accessories

Description	Color	Type	Part Numbers	Pkg qty	Weight (1 pce) g
1 End stops	Beige <input type="checkbox"/>	BAM2	1SNA296351R0000	50	12.00
		BAH24	1SNA168355R1300	50	12.00
2 End sections	Beige <input type="checkbox"/>	FJH501	1SNA199411R1400	25	6.50
3 Jumper bars		BJH311	1SNA163479R0300	10	233.00
4 Circuit separators	Beige <input type="checkbox"/>	SCH8	1SNA199412R1500	25	4.80
5 Spacers	Beige <input type="checkbox"/>	INH1	1SNA295427R1400	25	2.00
6 Protecting covers	Transparent <input checked="" type="checkbox"/>	CPM	1SNA187312R1400	1	25.00
	Beige <input type="checkbox"/>	CPM	1SNA197312R1600	10	25.00
7 Terminal block markers	White <input type="checkbox"/>	RTC	1SNA163156R2700	1	10.00
		PEFH	1SNA163497R1600	10	
		RPED	1SNA163518R2200	1	12.00
	White <input type="checkbox"/>	RC610	1SNA233000R0100	10	7.50

HD185/36.F12.31.1 stud terminal blocks

Feed-through - 36 mm 1.42 in spacing



Description

- 1 stud terminal M12 x 31.5 mm 1.24 in,
- Equipment: 1 bottom nut + 2 washers + 1 spring washer + 1 top nut.

Ordering details

Description	Color	Type	Part Numbers	Pkg qty	Weight (1 pce)
1 stud M12	Beige <input type="checkbox"/>	HD185/36.F12.31.1	1SNA295405R2700	10	79.00

Main technical data

Connecting capacity	NF C	DIN	NF F 61-017	Rail	Tool	Torque
Wire size	Lug (NF C 20-130) Lug (DIN 46235 / 46234) Quick-connect: 6.3 x 0.8 mm	35 ... 185 mm² 10 ... 150 mm²				
Rated voltage	V AC V DC	(Cat. C) 750 V (Cat. C) 750 V				
Rated current		353 A				
Rated cross section		185 mm²				

Mounting instructions

Type 2, TH 35-7.5, TH 35-15	
Wrench Ø 18 mm Ø 0.709 in	
14 N.m 123.9 lb.in	



HD185/36.F12.31.1

1SNC167088/0014

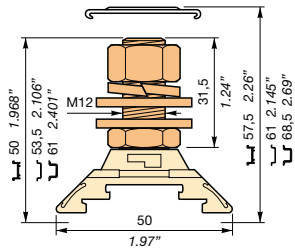

36 mm 1.42 in spacing

--	--	--

6

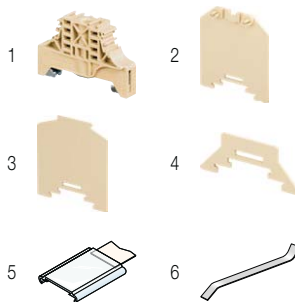

Accessories

Description	Color	Type	Part Numbers	Pkg qty	Weight (1 pce)
1 End stops	Beige <input type="checkbox"/>	BAM2	1SNA296351R0000	50	12.00
		BAH24	1SNA168355R1300	50	12.00
2 End sections	Beige <input type="checkbox"/>	FJH501	1SNA199411R1400	25	6.50
3 Circuit separators	Beige <input type="checkbox"/>	SCH8	1SNA199412R1500	25	4.80
4 Spacers	Beige <input type="checkbox"/>	INHD1	1SNA295427R1400	25	2.00
5 Protecting covers	Transparent <input checked="" type="checkbox"/>	CPM	1SNA187312R1400	1	25.00
	Beige <input type="checkbox"/>	CPM	1SNA197312R1600	10	25.00
6 Terminal block markers	White <input type="checkbox"/>	RTC	1SNA163156R2700	1	10.00
		PEFH	1SNA163497R1600	10	
		RPED	1SNA163518R2200	1	12.00
	White <input type="checkbox"/>	RC610	1SNA233000R0100	10	7.50

HD4/9.FF4 stud terminal blocks

Feed-through - 9.5 mm 0.374 in spacing

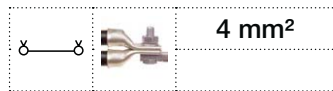

4 mm²

Description

- 2 stud terminals M4 x 11 mm 0.433 in,
- Equipment: self locking nut + spring washer + washer.



1SNC167110V0014

HD4/9.FF4

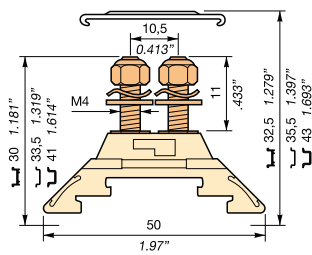

9.5 mm 0.374 in spacing

Ordering details

Description	Color	Type	Part Numbers	Pkg qty	Weight (1 pce) g
2 studs M4	Beige <input type="checkbox"/>	HD4/9.FF4	1SNA295393R2200	100	6.00

Main technical data

Connecting capacity		NF C	DIN	NF F 61-017	Rail	Tool	Torque
Wire size	Lug (NF C 20-130)	0.5 ... 4 mm ²					Type 2, TH 35-7.5, TH 35-15
	Lug (DIN 46235 / 46234)	0.5 ... 4 mm ²					
	Quick-connect: 6.3 x 0.8 mm						
Rated voltage	V AC	(Cat. C) 500 V				1.2 N.m 10.6 lb.in	
	V DC	(Cat. C) 500 V					
Rated current		32 A					
Rated cross section		4 mm ²					

Mounting instructions

--	--	--	--	--	--	--	--

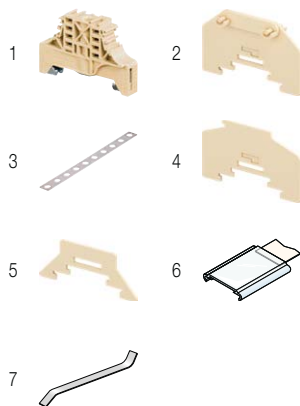

Accessories

Description	Color	Type	Part Numbers	Pkg qty	Weight (1 pce) g
1 End stops	Beige <input type="checkbox"/>	BAM2	1SNA296351R0000	50	12.00
		BAH22	1SNA164655R0400	50	10.00
2 End sections	Beige <input type="checkbox"/>	FJHD32	1SNA295431R1000	25	4.00
3 Jumper bars		BJH105	1SNA163503R2400	10	197.00
4 Circuit separators	Beige <input type="checkbox"/>	SCHD1	1SNA295428R2500	25	2.00
5 Spacers	Beige <input type="checkbox"/>	INH1	1SNA295427R1400	25	2.00
6 Protecting covers	Transparent <input checked="" type="checkbox"/>	CPM	1SNA187312R1400	1	25.00
		Beige <input type="checkbox"/>	CPM	1SNA197312R1600	10
7 Terminal block markers	White <input type="checkbox"/>	RTC	1SNA163156R2700	1	10.00
		PEFH	1SNA163497R1600	10	10.00
		RPED	1SNA163518R2200	1	12.00
		RC610	1SNA233000R0100	10	7.50

1SNC167066S0201

HD6/13.FF4 stud terminal blocks

Feed-through - 13 mm 0.512 in spacing

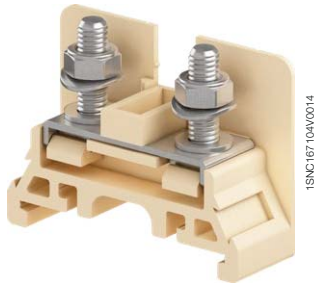

HD6/13.FF4

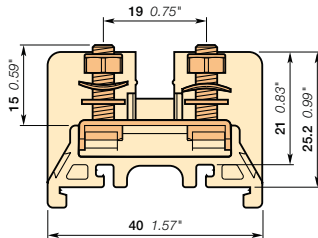

13 mm 0.512 in spacing

Description

- 2 stud terminals M4 x 15 mm 0.531 in,
- Equipment: self locking nut + spring washer + washer,
- NF F 61-017 designation: BE0013-FF4 (1SNA295014R1100).

Ordering details

Description	Color	Type	Part Numbers	Pkg qty	Weight (1 pce) g
2 studs M4	Beige <input type="checkbox"/>	HD6/13.FF4	1SNA295014R1100	10	15.00

Main technical data

Connecting capacity	NF C	DIN	NF F 61-017
Wire size	Lug (NF C 20-130) Lug (DIN 46235 / 46234) Quick-connect: 6.3 x 0.8 mm	0.5 ... 6 mm ² 0.5 ... 6 mm ²	
Rated voltage	V AC V DC	(Cat. C) 400 V (Cat. C) 250 V	(Cat. C) 380 V : 380 V (Cat. C) 450 V : 380 V
Rated current		51 A	47 A
Rated cross section		6 mm ²	51 A

Mounting instructions

Rail		Type 2, TH 35-7.5, TH 35-15
Tool		Wrench Ø 7 mm Ø 0.276 in
Torque		1.2 N.m 10.6 lb.in

--	--	--	--	--	--	--	--	--	--

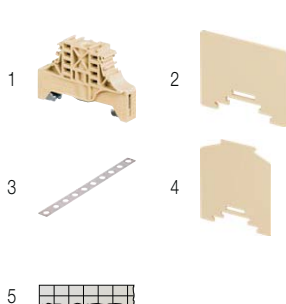

Accessories

Description	Color	Type	Part Numbers	Pkg qty	Weight (1 pce) g
1 End stops	Beige <input type="checkbox"/>	BAM2	1SNA296351R0000	50	12.00
		BAH21	1SNA167489R2200	50	8.00
2 End sections	Beige <input type="checkbox"/>	FEH8	1SNA198729R0100	25	4.30
3 Jumper bars		BJS13-10	1SNA167224R2700	10	10.00
4 Circuit separators	Beige <input type="checkbox"/>	SCH8	1SNA199412R1500	25	4.80
5 Terminal block markers	White <input type="checkbox"/>	REH3	1SNA163155R2600	1	20.00

HD10/12.FF5 stud terminal blocks

Feed-through - 12 mm 0.473 in spacing



10 mm²

Description

- 2 stud terminals M5 x 19.5 mm 0.768 in,
- Equipment: H 130 self locking nut + TREP 3L washer + washer.

Ordering details

Description	Color	Type	Part Numbers	Pkg qty	Weight (1 pce) g
2 studs M5	Beige <input type="checkbox"/>	HD10/12.FF5	1SNA295397R2600	50	11.00

Main technical data

Connecting capacity		NF C	DIN	NF F 61-017	Mounting instructions	
Wire size	Lug (NF C 20-130)	0.5 ... 10 mm ²			Rail	Type 2, TH 35-7.5, TH 35-15
	Lug (DIN 46235 / 46234)		0.5 ... 10 mm ²		Tool	Wrench Ø 8 mm Ø 0.315 in
	Quick-connect: 6.3 x 0.8 mm					
Rated voltage	V AC	(Cat. C) 750 V			Torque	2.5 N.m 22.1 lb.in
	V DC	(Cat. C) 750 V				
Rated current		57 A				
Rated cross section		10 mm ²				



1SNIC167098V001.4

HD10/12.FF5

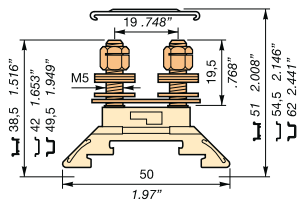

12 mm 0.473 in spacing

CE CE	RoHS RoHS	EAC EAC																	
-----------------	---------------------	-------------------	--	--	--	--	--	--	--	--	--	--	--	--	--	--	--	--	--

The use of a jumper bar requires to use a spacer instead of a circuit separator.

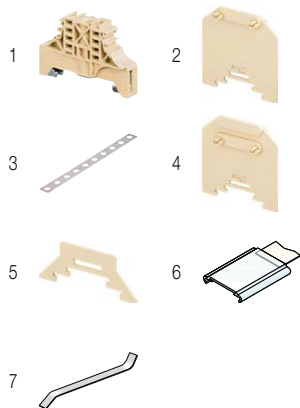

Accessories

Description	Color	Type	Part Numbers	Pkg qty	Weight (1 pce) g
1 End stops	Beige <input type="checkbox"/>	BAM2	1SNA296351R0000	50	12.00
		BAH22	1SNA164655R0400	50	10.00
2 End sections	Beige <input type="checkbox"/>	FJHD50	1SNA295425R1200	25	4.00
3 Jumper bars		BJH131-10	1SNA163468R0000	10	59.00
4 Circuit separators	Beige <input type="checkbox"/>	FJDHD	1SNA295426R1300	25	4.00
		SCHD5	1SNA295430R2300	25	2.00
5 Spacers	Beige <input type="checkbox"/>	INH1	1SNA295427R1400	25	2.00
6 Protecting covers	Transparent <input checked="" type="checkbox"/>	CPM	1SNA187312R1400	1	25.00
		CPM	1SNA197312R1600	10	25.00
		RTC	1SNA163156R2700	1	10.00
		PEFH	1SNA163497R1600	10	
		RPED	1SNA163518R2200	1	12.00
7 Terminal block markers	White <input type="checkbox"/>	RC610	1SNA233000R0100	10	7.50

HD16/14.FF5.21.3 stud terminal blocks

Feed-through - 14 mm 0.551 in spacing

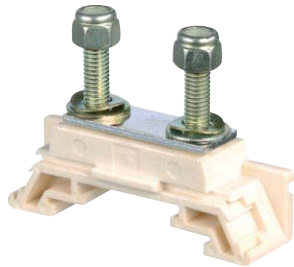
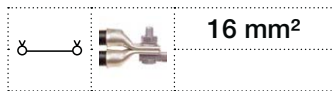

1SNC16702CF0014

HD16/14.FF5.21.3

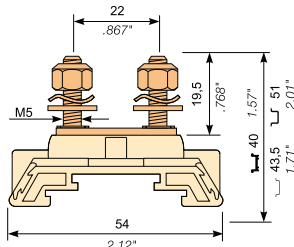

14 mm 0.551 in spacing

Description

- 2 stud terminals M5 x 19.5 mm 0.768 in,
- Equipment: self locking nut + spring washer + washer,
- 18 mm 0.709 in spacing adding SCH6 or INH3,
- Two jumpering options: 14 mm 0.551 in spacing with BJH14 and 18 mm 0.709 in spacing (adding INH3) with BJH18,
- NF F 61-017 designation: BE0018-FF5 (1SNA295012R1700 + SCH6 or INH3).

Ordering details

Description	Color	Type	Part Numbers	Pkg qty	Weight (1 pce) g
2 studs M5	Beige <input type="checkbox"/>	HD16/14.FF5.21.3	1SNA295012R1700	25	24.00

Main technical data

Connecting capacity		NF C	DIN	NF F 61-017	Mounting instructions	
Wire size	Lug (NF C 20-130)	0.5 ... 16 mm²	0.5 ... 16 mm²		Rail	Type 2, TH 35-7.5, TH 35-15
	Lug (DIN 46235 / 46234)				Tool	Wrench Ø 8 mm Ø 0.315 in
Rated voltage	Quick-connect: 6.3 x 0.8 mm					
	V AC	(Cat. C) 500 V	(Cat. C) 500 V	380 V	Torque	2.5 N.m 22.1 lb.in
V DC	(Cat. C) 500 V	(Cat. C) 600 V	500 V			
Rated current		71 A	65 A	71 A		
Rated cross section		16 mm²				

CE	RoHS	EAC																	
----	------	-----	--	--	--	--	--	--	--	--	--	--	--	--	--	--	--	--	--

The use of a jumper bar requires to use a spacer instead of a circuit separator.

6

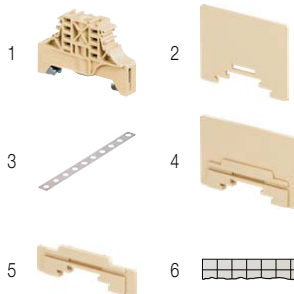

Accessories

Description	Color	Type	Part Numbers	Pkg qty	Weight (1 pce) g	
1 End stops	Beige <input type="checkbox"/>	BAM2	1SNA296351R0000	50	12.00	
		BAH22	1SNA164655R0400	50	10.00	
2 End sections	Beige <input type="checkbox"/>	FEH8	1SNA198729R0100	25	4.30	
3 Jumper bars		2 poles	BJH14-2	1SNA173438R2400	1	5.30
		3 poles	BJH14-3	1SNA173439R2500	10	8.30
		4 poles	BJH14-4	1SNA173441R2700	10	11.20
		5 poles	BJH14-5	1SNA173449R0700	10	14.20
		10 poles	BJH14-10	1SNA173451R2100	1	28.00
		2 poles	BJH18-2	1SNA173452R2200	1	6.20
		3 poles	BJH18-3	1SNA173453R2300	1	9.90
		4 poles	BJH18-4	1SNA173454R2400	1	13.80
		5 poles	BJH18-5	1SNA173460R0600	1	17.50
		10 poles	BJH18-10	1SNA173461R2300	1	36.90
4 Circuit separators	Beige <input type="checkbox"/>	SCH6	1SNA199393R2200	20		
5 Spacers	Beige <input type="checkbox"/>	INH3	1SNA199394R2300	25	2.60	
6 Terminal block markers	White <input type="checkbox"/>	REH3	1SNA163155R2600	1	20.00	
		RC610	1SNA233000R0100	10	7.50	

HD16/14.FF5.20.3 stud terminal blocks

Feed-through - 14 mm 0.551 in spacing

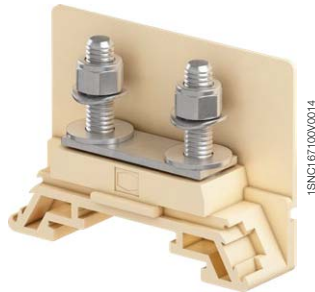

HD16/14.FF5.20.3

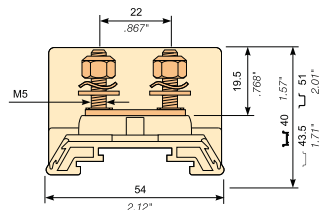

14 mm 0.551 in spacing

Description

- 2 stud terminals M5 x 19.5 mm 0.768 in,
- Equipment: self locking nut + spring washer + washer,
- NF F 61-017 designation: BE0014-FF5 (1SNA295013R1000).

Ordering details

Description	Color	Type	Part Numbers	Pkg qty	Weight (1 pce) g
2 studs M5	Beige <input type="checkbox"/>	HD16/14.FF5.20.3	1SNA295013R1000	25	26.00

Main technical data

Connecting capacity		NF C	DIN	NF F 61-017	Rail	Tool	Torque
Wire size	Lug (NF C 20-130)	0.5 ... 16 mm ²			Type 2, TH 35-7.5, TH 35-15	Wrench Ø 8 mm Ø 0.315 in	2.5 N.m 22.1 lb.in
	Lug (DIN 46235 / 46234)	0.5 ... 16 mm ²					
	Quick-connect: 6.3 x 0.8 mm						
Rated voltage	V AC	(Cat. C) 500 V	(Cat. C) 500 V	380 V	Torque	2.5 N.m 22.1 lb.in	
	V DC	(Cat. C) 500 V	(Cat. C) 600 V	500 V			
Rated current		71 A	65 A	51 A			
Rated cross section		16 mm ²					

Mounting instructions

CE	RoHS	EAC					
----	------	-----	--	--	--	--	--

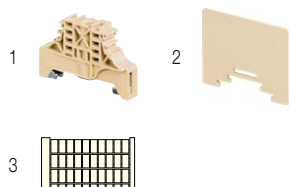

Accessories

Description	Color	Type	Part Numbers	Pkg qty	Weight (1 pce) g
1 End stops	Beige <input type="checkbox"/>	BAM2	1SNA296351R0000	50	12.00
		BAH22	1SNA164655R0400	50	10.00
2 End sections	Beige <input type="checkbox"/>	FEH8	1SNA198729R0100	25	4.30
3 Terminal block markers	White <input type="checkbox"/>	RC610	1SNA233000R0100	10	7.50

HD16/14.FF5.21 stud terminal blocks

Feed-through - 14 mm 0.551 in spacing

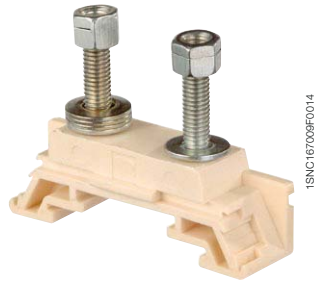
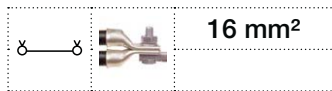

1SNC167024S0201

HD16/14.FF5.21

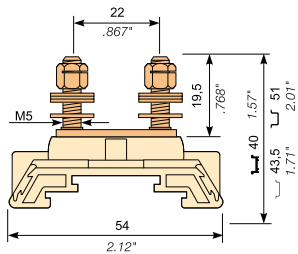

14 mm 0.551 in spacing

Description

- 2 stud terminals M5 x 19.5 mm 0.768 in,
- Equipment: H 130 self locking nut + TREP 3L washer + washer,
- 18 mm 0.709 in spacing adding SCH6 or INH3,
- Two jumpering options: 14 mm 0.551 in spacing with BJH14 and 18 mm 0.709 in spacing (adding INH3) with BJH18.

Ordering details

Description	Color	Type	Part Numbers	Pkg qty	Weight (1 pce) g
2 studs M5	Beige	HD16/14.FF5.21	1SNA162991R1400	25	30.00

Main technical data

Connecting capacity	NF C	DIN	NF F 61-017	Rail	Tool	Torque
Wire size	Lug (NF C 20-130) Lug (DIN 46235 / 46234) Quick-connect: 6.3 x 0.8 mm	0.5 ... 16 mm ²	0.5 ... 16 mm ²	Type 2, TH 35-7.5, TH 35-15	Wrench Ø 8 mm Ø 0.315 in	2.5 N.m 22.1 lb.in
Rated voltage	V AC V DC	(Cat. C) 500 V (Cat. C) 500 V	(Cat. C) 500 V (Cat. C) 600 V			
Rated current		71 A	65 A			
Rated cross section		16 mm ²				

Mounting instructions

--	--	--	--	--	--	--	--	--	--	--

The use of a jumper bar requires to use a spacer instead of a circuit separator.

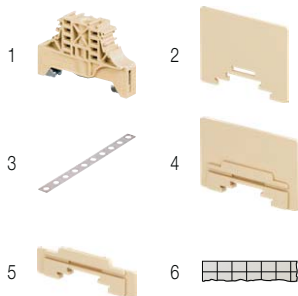

Accessories

Description	Color	Type	Part Numbers	Pkg qty	Weight (1 pce) g
1 End stops	Beige	BAM2	1SNA296351R0000	50	12.00
		BAH22	1SNA164655R0400	50	10.00
2 End sections	Beige	FEH8	1SNA198729R0100	25	4.30
3 Jumper bars		BJH14-2	1SNA173438R2400	1	5.30
		BJH14-3	1SNA173439R2500	10	8.30
		BJH14-4	1SNA173441R2700	10	11.20
		BJH14-5	1SNA173449R0700	10	14.20
		BJH14-10	1SNA173451R2100	1	28.00
		BJH18-2	1SNA173452R2200	1	6.20
		BJH18-3	1SNA173453R2300	1	9.90
		BJH18-4	1SNA173454R2400	1	13.80
		BJH18-5	1SNA173460R0600	1	17.50
		BJH18-10	1SNA173461R2300	1	36.90
4 Circuit separators	Beige	SCH6	1SNA199393R2200	20	
5 Spacers	Beige	INH3	1SNA199394R2300	25	2.60
6 Terminal block markers	White	REH3	1SNA163155R2600	1	20.00
		RC610	1SNA233000R0100	10	7.50

HD16/14.FF5.20 stud terminal blocks

Feed-through - 14 mm 0.551 in spacing

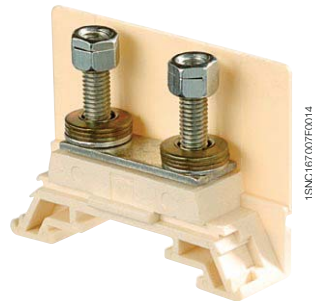

HD16/14.FF5.20

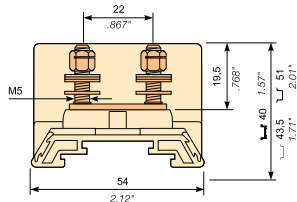

14 mm 0.551 in spacing

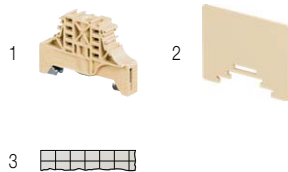

Description

- 2 stud terminals M5 x 19.5 mm 0.768 in,
- Equipment: H 130 self locking nut + TREP 3L washer + washer.

Ordering details

Description	Color	Type	Part Numbers	Pkg qty	Weight (1 pce) g
2 studs M5	Beige <input type="checkbox"/>	HD16/14.FF5.20	1SNA162979R0700	25	27.00

Main technical data

Connecting capacity	NF C	DIN	NF F 61-017
Wire size	Lug (NF C 20-130) Lug (DIN 46235 / 46234) Quick-connect: 6.3 x 0.8 mm	0.5 ... 16 mm² 0.5 ... 16 mm²	
Rated voltage	V AC V DC	(Cat. C) 500 V (Cat. C) 500 V	(Cat. C) 500 V (Cat. C) 600 V 380 V 500 V
Rated current		71 A	65 A 51 A
Rated cross section		16 mm²	

Mounting instructions

Rail		Type 2, TH 35-7.5, TH 35-15
Tool		Wrench Ø 8 mm Ø 0.315 in
Torque		2.5 N.m 22.1 lb.in

--	--	--	--	--	--	--	--	--	--	--	--	--	--	--	--	--	--	--	--

Accessories

Description	Color	Type	Part Numbers	Pkg qty	Weight (1 pce) g
1 End stops	Beige <input type="checkbox"/>	BAM2	1SNA296351R0000	50	12.00
		BAH22	1SNA164655R0400	50	10.00
2 End sections	Beige <input type="checkbox"/>	FEH8	1SNA198729R0100	25	4.30
3 Terminal block markers	White <input type="checkbox"/>	REH3	1SNA163155R2600	1	20.00
		RC610	1SNA233000R0100	10	7.50

D35/27.FF power terminal blocks

Feed-through - 27 mm 1.062 in spacing

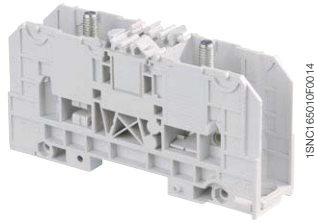

D35/27.FF

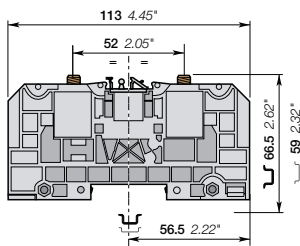

27 mm 1.062 in spacing

Description

- Rated cross section up to 300 mm² / 1000 Kcmil, IP20 protection cover,
- Holding foot on DIN 3 rail with two position for easy mounting, lug mounting in accordance with NF C 20-130 and DIN 46234, various marking options, rail or base mounting.

Ordering details

Description	Color	Type	Part Number	Pkg qty	Weight (1 pce) g
Feed-through 2 studs M6 without cover	Grey <input type="checkbox"/>	D35/27.FF	1SNA190001R2000	10	130.00

Main technical data

Connecting capacity		NF C	DIN	UL	CSA
Lugs	Rigid: Solid/Stranded	2.5-35 mm ²	2.5-50 mm ²	1 AWG	
	Flexible with insulated ferrule	2.5-35 mm ²	2.5-35 mm ²		
	Gauge	C4			
Screw clamp	Rigid: Solid/Stranded				
	Flexible without ferrule				
	Gauge				
Bar		IEC		UL	CSA
	Rated current	125 A		125 A	
	Rated cross section	35 mm ²		1 AWG	
	Rated voltage	1000 V		600 V	
	Impulse withstand voltage	8000 V			

Mounting instructions

Rail		TH 35-7.5, TH 35-15
Lugs		Wrench H10 mm
Tool		
Torque		3 - 6 N.m 26.1 - 52 lb.in
Jumper screw		Allen key 6 mm
Tool		0.236 in
Torque		6 - 12 N.m 52 - 104 lb.in
Screw clamp		
Tool		
Torque		
Wire stripping length		

The connecting capacity data for one Rigid: Solid/Stranded, or one Flexible conductor (when applicable) is a mandatory information required by IEC, UL and CSA standards (Copper conductors). All other data are provided as supplementary information only. For more details, please consult our CB, UL or CSA certificates and technical datasheet available on <http://www.TE.com>



Accessories

Description	Color	Type	Part Number	Pkg qty	Weight (1 pce) g
1 End stops 10 mm 0.394 in	Dark grey <input type="checkbox"/>	BAZH1	1SNK900102R0000	20	24.00
2 Jumper bars 2 poles		BJS27-2	1SNA205772R1300	5	34.00
3 poles		BJS27-3	1SNA205773R1400	5	52.00
3 Splitters For 6.35x0.8mm faston clips and screws		DRF6	1SNA205767R1600	10	4.00
4 Protecting covers IP20 rotating protecting cover	Grey <input type="checkbox"/>	CPUF35	1SNA190016R1600	2	8.30
5 Terminal block markers Blank card	White <input type="checkbox"/>	RC810	1SNA234000R0200	1	8.20

Complete list of accessories is indicated in the terminal block datasheet.

Some accessories such as jumper bars may modify the terminal block's ratings: complete information in the accessories catalogue pages.

Technical data valid for copper conductors only.

D70/32.FF power terminal blocks

Feed-through - 32 mm 1.260 in spacing



70 mm²
000 AWG

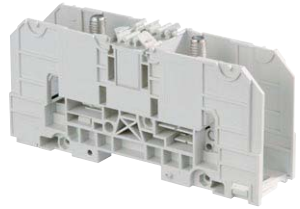

1SNC165009R0014

D70/32.FF

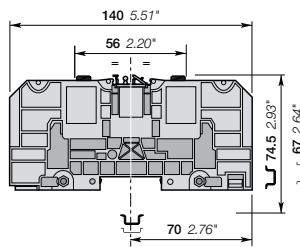

32 mm 1.260 in spacing

Description

- Rated cross section up to 300 mm² / 1000 Kcmil, IP20 protection cover,
- Holding foot on DIN 3 rail with two position for easy mounting, lug mounting in accordance with NF C 20-130 and DIN 46234, various marking options, rail or base mounting.

Ordering details

Description	Color	Type	Part Number	Pkg qty	Weight (1 pce)
Feed-through 2 studs M8 without cover	Grey <input type="checkbox"/>	D70/32.FF	1SNA190002R2100	3	269.00 g

Main technical data

Connecting capacity	NF C	DIN	UL	CSA	Mounting instructions		
Lugs	Rigid: Solid/Stranded	6-95 mm ²	6-70 mm ²	000 AWG	Rail		TH 35-7.5, TH 35-15
	Flexible with insulated ferrule	6-70 mm ²	6-70 mm ²			Lugs	
	Gauge	C6			Tool		
					Torque		6 - 12 N.m 52 - 104 lb.in
Screw clamp	Rigid: Solid/Stranded				Jumper screw		Allen key
	Flexible without ferrule					Tool	
	Gauge				Torque		6 - 12 N.m 52 - 104 lb.in
Bar					Screw clamp		
	Rated current	192 A		170 A		Tool	
Rated cross section	70 mm ²			000 AWG	Torque		
Rated voltage	1000 V			600 V	Wire stripping length		
Impulse withstand voltage	8000 V						

The connecting capacity data for one Rigid: Solid/Stranded, or one Flexible conductor (when applicable) is a mandatory information required by IEC, UL and CSA standards (Copper conductors). All other data are provided as supplementary information only. For more details, please consult our CB, UL or CSA certificates and technical datasheet available on <http://www.TE.com>



Accessories

Description	Color	Type	Part Number	Pkg qty	Weight (1 pce)
1 End stops 10 mm 0.394 in	Dark grey <input checked="" type="checkbox"/>	BAZH1	1SNC900102R0000	20	24.00
2 Jumper bars 2 poles		BJS32-2	1SNA205774R1500	5	66.00
3 poles		BJS32-3	1SNA205775R1600	5	105.80
3 Splitters For 6.35x0.8mm faston clips and screws		DRF8	1SNA205768R2700	10	5.00
4 Protecting covers IP20 rotating protecting cover	Grey <input type="checkbox"/>	CPUF70	1SNA190017R1700	2	12.00
5 Terminal block markers Blank card	White <input type="checkbox"/>	RC810	1SNA234000R0200	1	8.20

Complete list of accessories is indicated in the terminal block datasheet. Some accessories such as jumper bars may modify the terminal block's ratings: complete information in the accessories catalogue pages.

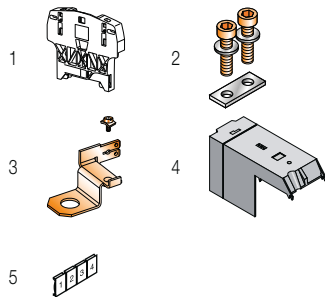

Technical data valid for copper conductors only.

D120/42.FF power terminal blocks

Feed-through - 42 mm 1.653 in spacing

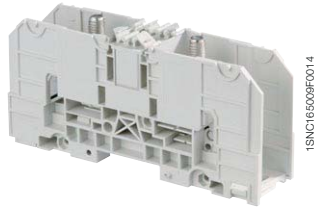

D120/42.FF

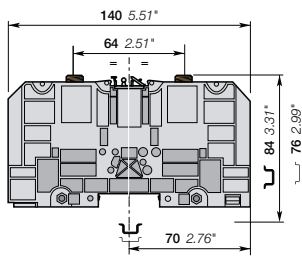

42 mm 1.653 in spacing

Description

- Rated cross section up to 300 mm² / 1000 Kcmil, IP20 protection cover,
- Holding foot on DIN 3 rail with two position for easy mounting, lug mounting in accordance with NF C 20-130 and DIN 46234, various marking options, rail or base mounting.

Ordering details

Description	Color	Type	Part Number	Pkg qty	Weight (1 pce) g
Feed-through 2 studs M10 without cover	Grey <input type="checkbox"/>	D120/42.FF	1SNA190003R2200	1	423.00

Main technical data

Connecting capacity		NF C	DIN	UL	CSA
Lugs	Rigid: Solid/Stranded	6-150 mm ²	6-120 mm ²	300 Kcmil	
	Flexible with insulated ferrule	6-120 mm ²			
	Gauge	C8			
Screw clamp		IEC	UL	CSA	
Bar	Rigid: Solid/Stranded				
	Flexible without ferrule				
	Gauge				
Rated current		269 A		269 A	
Rated cross section		120 mm ²		300 Kcmil	
Rated voltage		1000 V		600 V	
Impulse withstand voltage		8000 V			

Mounting instructions

Rail		TH 35-7.5, TH 35-15
Lugs		Wrench H17 mm
Tool		
Torque		10 - 20 N.m 87 - 174 lb.in
Jumper screw		Allen key 6 mm 0.236 in
Tool		
Torque		6 - 12 N.m 52 - 104 lb.in
Screw clamp		
Tool		
Torque		
Wire stripping length		

The connecting capacity data for one Rigid: Solid/Stranded, or one Flexible conductor (when applicable) is a mandatory information required by IEC, UL and CSA standards (Copper conductors). All other data are provided as supplementary information only. For more details, please consult our CB, UL or CSA certificates and technical datasheet available on <http://www.TE.com>

RoHS <input type="checkbox"/>	UL <input type="checkbox"/>	PC <input type="checkbox"/>							
RoHS	UL	PC	Gost R						

Accessories

Description	Color	Type	Part Number	Pkg qty	Weight (1 pce) g
1 End stops 10 mm 0.394 in	Dark grey <input type="checkbox"/>	BZH1	1SNK900102R0000	20	24.00
2 Jumper bars 2 poles		BJS42-2	1SNA205776R1700	5	93.00
3 poles		BJS42-3	1SNA205777R1000	5	153.00
3 Splitters For 6.35x0.8mm faston clips and screws		DRF10	1SNA205769R2000	10	7.00
4 Protecting covers IP20 rotating protecting cover	Grey <input type="checkbox"/>	CPUF120	1SNA190018R2000	2	24.00
5 Terminal block markers Blank card	White <input type="checkbox"/>	RC810	1SNA234000R0200	1	8.20

Complete list of accessories is indicated in the terminal block datasheet.

Some accessories such as jumper bars may modify the terminal block's ratings: complete information in the accessories catalogue pages.

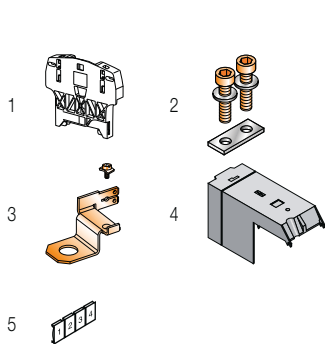

Technical data valid for copper conductors only.

D185/55.FF power terminal blocks

Feed-through - 55 mm 2.165 in spacing

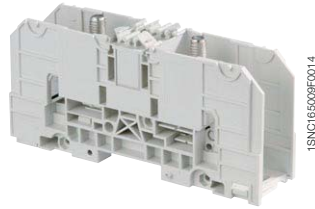

D185/55.FF

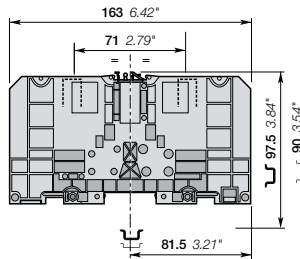

55 mm 2.165 in spacing

Description

- Rated cross section up to 300 mm² / 1000 Kcmil, IP20 protection cover,
- Holding foot on DIN 3 rail with two position for easy mounting, lug mounting in accordance with NF C 20-130 and DIN 46234, various marking options, rail or base mounting.

Ordering details

Description	Color	Type	Part Number	Pkg qty	Weight (1 pce) g
Feed-through 2 studs M12 without cover	Grey <input type="checkbox"/>	D185/55.FF	1SNA190004R2300	1	615.00

Main technical data

Connecting capacity	NF C	DIN	UL	CSA
Lugs	Rigid: Solid/Stranded 25-240 mm ² Flexible with insulated ferrule 6-185 mm ² Gauge C11	6-185 mm ²	500 Kcmil	
Screw clamp	Rigid: Solid/Stranded Flexible without ferrule Gauge			
Bar				
Rated current	353 A		353 A	
Rated cross section	185 mm ²		500 Kcmil	
Rated voltage	1000 V		600 V	
Impulse withstand voltage	8000 V			

Mounting instructions

Rail		TH 35-7.5, TH 35-15
Lugs		Wrench H24 mm
Tool		
Torque		14 - 30 N.m 123.9 - 265.5 lb.in
Jumper screw		Allen key 6 mm 0.236 in
Tool		
Torque		6 - 12 N.m 52 - 104 lb.in
Screw clamp		
Tool		
Torque		
Wire stripping length		

The connecting capacity data for one Rigid: Solid/Stranded, or one Flexible conductor (when applicable) is a mandatory information required by IEC, UL and CSA standards (Copper conductors). All other data are provided as supplementary information only. For more details, please consult our CB, UL or CSA certificates and technical datasheet available on <http://www.TE.com>

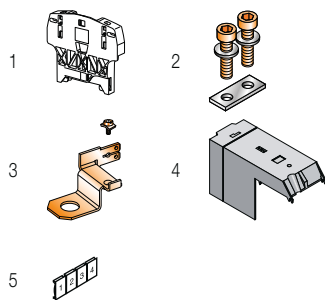

Accessories

Description	Color	Type	Part Number	Pkg qty	Weight (1 pce) g
1 End stops 10 mm 0.394 in	Dark grey <input checked="" type="checkbox"/>	BAZH1	1SNK900102R0000	20	24.00
2 Jumper bars 2 poles		BJS551-2	1SNA205778R2100	5	158.00
3 poles		BJS551-3	1SNA205779R2200	5	266.00
3 Splitters For 6.35x0.8mm faston clips and screws		DRF12	1SNA205770R2500	10	8.00
4 Protecting covers IP20 rotating protecting cover	Grey <input type="checkbox"/>	CPUF185	1SNA190019R2100	2	40.00
5 Terminal block markers Blank card	White <input type="checkbox"/>	RC810	1SNA234000R0200	1	8.20

Complete list of accessories is indicated in the terminal block datasheet. Some accessories such as jumper bars may modify the terminal block's ratings: complete information in the accessories catalogue pages.

Technical data valid for copper conductors only.

D300/55.FF power terminal blocks

Feed-through - 55 mm 2.165 in spacing

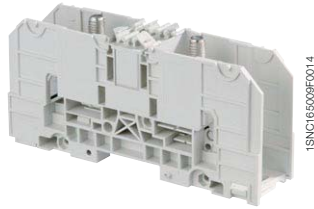

D300/55.FF

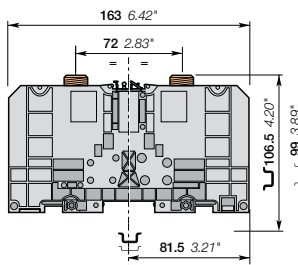

55 mm 2.165 in spacing

Description

- Rated cross section up to 300 mm² / 1000 Kcmil, IP20 protection cover,
- Holding foot on DIN 3 rail with two position for easy mounting, lug mounting in accordance with NF C 20-130 and DIN 46234, various marking options, rail or base mounting.

Ordering details

Description	Color	Type	Part Number	Pkg qty	Weight (1 pce) g
Feed-through 2 studs M16 without cover	Grey <input type="checkbox"/>	D300/55.FF	1SNA190005R2400	1	775.00

Main technical data

Connecting capacity		NF C	DIN	UL	CSA
Lugs	Rigid: Solid/Stranded	25-300 mm ²	6-300 mm ²	1000 Kcmil	
	Flexible with insulated ferrule	6-300 mm ²			
Gauge					
Screw clamp		IEC	UL	CSA	
Screw clamp	Rigid: Solid/Stranded				
	Flexible without ferrule				
Gauge					
Bar		IEC	UL	CSA	
Rated current		520 A		460 A	
Rated cross section		300 mm ²		1000 Kcmil	
Rated voltage		1000 V		600 V	
Impulse withstand voltage		8000 V			

Mounting instructions

Rail		TH 35-7.5, TH 35-15
Lugs		Wrench H24 mm
Tool		
Torque		25 - 50 N.m 217 - 435 lb.in
Jumper screw		Allen key 6 mm 0.236 in
Tool		
Torque		6 - 12 N.m 52 - 104 lb.in
Screw clamp		
Tool		
Torque		
Wire stripping length		

The connecting capacity data for one Rigid: Solid/Stranded, or one Flexible conductor (when applicable) is a mandatory information required by IEC, UL and CSA standards (Copper conductors). All other data are provided as supplementary information only. For more details, please consult our CB, UL or CSA certificates and technical datasheet available on <http://www.TE.com>

RoHS:	RoHS:	UL:	UL:	Gost R:
-------	-------	-----	-----	---------

Accessories

Description	Color	Type	Part Number	Pkg qty	Weight (1 pce) g
1 End stops 10 mm 0.394 in	Dark grey <input type="checkbox"/>	BAZH1	1SNK900102R0000	20	24.00
2 Jumper bars 2 poles		BJS551-2	1SNA205778R2100	5	158.00
3 poles		BJS551-3	1SNA205779R2200	5	266.00
3 Splitters For 6.35x0.8mm faston clips and screws		DRF16	1SNA205771R1200	10	7.00
4 Protecting covers IP20 rotating protecting cover	Grey <input type="checkbox"/>	CPUF185	1SNA190019R2100	2	40.00
5 Terminal block markers Blank card	White <input type="checkbox"/>	RC810	1SNA234000R0200	1	8.20

Complete list of accessories is indicated in the terminal block datasheet.

Some accessories such as jumper bars may modify the terminal block's ratings: complete information in the accessories catalogue pages.

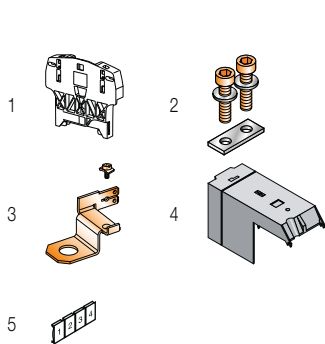

Technical data valid for copper conductors only.

RGW2.5 Ring lug terminal blocks

Feed-through - 9 mm 0.354 in spacing

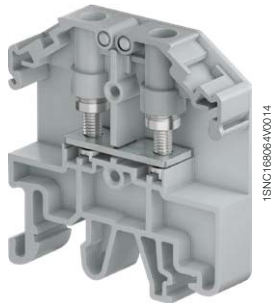
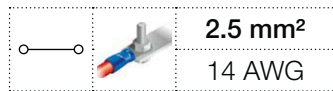

RGW2.5

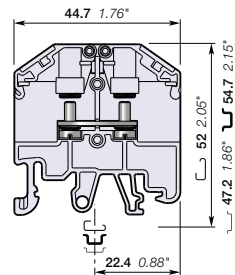

9 mm 0.354 in spacing

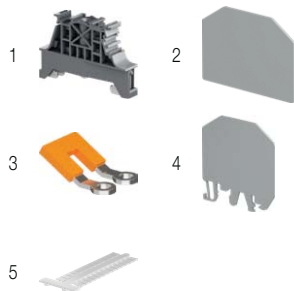

Description

- Stud terminal block for ring lug connection,
- Integrated captive nuts in protective wings provide easy and secured connection,
- Universal mounting on symmetrical and asymmetrical rails.

Ordering details

Description	Color	Type	Part Numbers	Pkg qty	Weight (1 pce) g
Feed-through With 2 studs M3 and captive nuts in wings	Grey <input type="checkbox"/>	RGW2.5-V0	1SNA510003R0000	45	11.78

Main technical data

Lugs	Rigid: Solid/Stranded Flexible with insulated ferrule Gauge	IEC	UL	CSA
		0.1 ... 2.5 mm ²	26 ... 14 AWG	26 ... 14 AWG
Rated current		24 A	15 A	20 A
Maximum current			20 A	
Rated cross section	2.5 mm ²		14 AWG	14 AWG
Rated short-time withstand current (1s)	300 A			
Rated voltage	800 V	600 V	600 V	
Impulse withstand voltage	8000 V			
Protection	IP10	NEMA 1		

Mounting instructions

Rail		G32, TH 35-7.5, TH 35-15
Nuts		Flat screwdriver Ø 4 mm Ø 0.157 in
Tool		
Torque		0.6 ... 0.8 N.m 5.3 ... 7.1 lb.in
Max width of lug		7 mm 0.28 in

The connecting capacity data for one Rigid: Solid/Stranded, or one Flexible conductor (when applicable) is a mandatory information required by IEC, UL and CSA standards (Copper conductors). All other data are provided as supplementary information only. For more details, please consult our CB, UL or CSA certificates and technical datasheet available on <http://www.TE.com>

CE	RoHS	UL	CSA

Accessories

Description	Color	Type	Part Numbers	Pkg qty	Weight (1 pce) g
1 End stops 10 mm 0.394 in	Dark grey <input type="checkbox"/>	BAM4	1SNK900001R0000	50	14.00
2 End sections 1.2 mm 0.047 in	Grey <input type="checkbox"/>	E-RGW2.5	1SNA519003R0000	25	1.89
3 Lateral jumper bars 2 poles 24 A (IEC) 3 poles 24 A (IEC) 4 poles 24 A (IEC) 10 poles 24 A (IEC)	Orange <input type="checkbox"/>	PC-RG2.5-2	1SNA519103R0200	25	3.02
		PC-RG2.5-3	1SNA519103R0300	20	4.69
		PC-RG2.5-4	1SNA519103R0400	15	6.36
		PC-RG2.5-10	1SNA519103R1000	5	16.39
4 Circuit separators 1.5 mm 0.059 in	Grey <input type="checkbox"/>	CS-RGW-S	1SNA519200R0000	25	4.59
5 Terminal block markers	White <input type="checkbox"/>	M-W610PC	1SNA235511R0600	360	8.03
		MG-CPM-01 41090	1SNB041090R0510	1960	0.351

Complete list of accessories is indicated in the terminal block datasheet including end stops.

Some accessories such as jumper bars may modify the terminal block's ratings: Complete information available in the accessories section of the catalog.

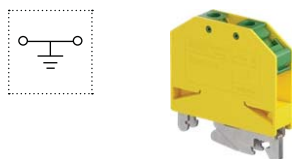

Ground Ring lug terminal blocks

Description	Color	Type	Part Numbers	Pkg qty	Weight (1 pce) g
Ground With 2 studs M3 and captive nuts in wings	Green-yellow <input type="checkbox"/>	RGW2.5-PE-V0	1SNA511003R0500	45	28.56

Technical data valid for copper conductors only.

RGW6 Ring lug terminal blocks

Feed-through - 11 mm 0.433 in spacing

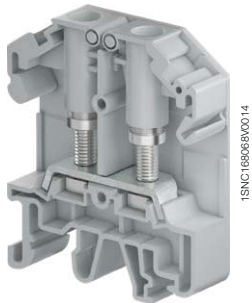
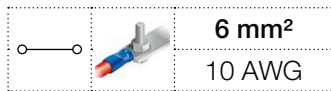

RGW6

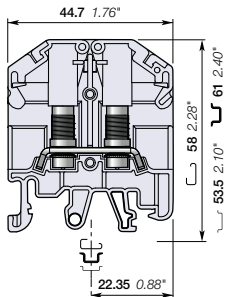

11 mm 0.433 in spacing

Description

- Stud terminal block for ring lug connection,
- Integrated captive nuts in protective wings provide easy and secured connection,
- Universal mounting on symmetrical and asymmetrical rails.

Ordering details

Description	Color	Type	Part Numbers	Pkg qty	Weight (1 pce) g
Feed-through With 2 studs M4 and captive nuts in wings	Grey <input type="checkbox"/>	RGW6-V0	1SNA510024R0000	40	19.76

Main technical data

Lugs	Rigid: Solid/Stranded Flexible with insulated ferrule Gauge	IEC	UL	CSA
		0.1 ... 6 mm²	22 ... 10 AWG	22 ... 10 AWG
Rated current		41 A	30 A	30 A
Maximum current			30 A	
Rated cross section		6 mm²	10 AWG	10 AWG
Rated short-time withstand current (1s)		720 A		
Rated voltage		800 V	600 V	600 V
Impulse withstand voltage		8000 V		
Protection		IP10	NEMA 1	

Mounting instructions

Rail		G32, TH 35-7.5, TH 35-15
Nuts		Flat screwdriver Ø 5.5 mm Ø 0.217 in
Tool		
Torque		0.8 ... 1.2 N.m 7.1 ... 10.6 lb.in
Max width of lug		9.4 mm 0.37 in

The connecting capacity data for one Rigid: Solid/Stranded, or one Flexible conductor (when applicable) is a mandatory information required by IEC, UL and CSA standards (Copper conductors). All other data are provided as supplementary information only. For more details, please consult our CB, UL or CSA certificates and technical datasheet available on <http://www.TE.com>

CE	RoHS	UL	CSA
CE	RoHS	UL	CSA

Accessories

Description	Color	Type	Part Numbers	Pkg qty	Weight (1 pce) g
1 End stops 10 mm 0.394 in	Dark grey <input type="checkbox"/>	BAM4	1SNK900001R0000	50	14.00
2 End sections 1.4 mm 0.055 in	Grey <input type="checkbox"/>	E-RGW6	1SNA519004R0000	50	2.65
3 Lateral jumper bars 2 poles 41 A (IEC)	Orange <input type="checkbox"/>	PC-RG6-2	1SNA519104R0200	25	3.44
3 Lateral jumper bars 3 poles 41 A (IEC)		PC-RG6-3	1SNA519104R0300	20	5.40
3 Lateral jumper bars 4 poles 41 A (IEC)		PC-RG6-4	1SNA519104R0400	15	7.33
3 Lateral jumper bars 7 poles 41 A (IEC)		PC-RG6-7	1SNA519104R0700	5	13.24
3 Lateral jumper bars 10 poles 41 A (IEC)		PC-RG6-10	1SNA519104R1000	5	19.05
4 Circuit separators 1.5 mm 0.059 in	Grey <input type="checkbox"/>	CS-RGW-S	1SNA519200R0000	25	4.59
5 Terminal block markers	White <input type="checkbox"/>	M-W810PC	1SNA235510R0800	260	0.27
		MG-CPM-01 41096	1SNB041096R0810	1120	0.400

Complete list of accessories is indicated in the terminal block datasheet including end stops.

Some accessories such as jumper bars may modify the terminal block's ratings: Complete information available in the accessories section of the catalog.



Ground Ring lug terminal blocks

Description	Color	Type	Part Numbers	Pkg qty	Weight (1 pce) g
Ground With 2 studs M4 and captive nuts in wings	Green-yellow <input type="checkbox"/>	RGW6-PE-V0	1SNA511024R0500	40	31.76

Technical data valid for copper conductors only.

RGW25-M5 Ring lug terminal blocks

Feed-through - 18 mm 0.709 in spacing

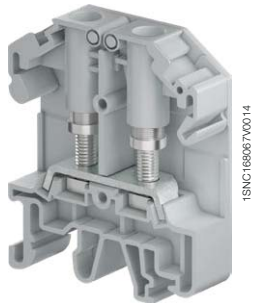

RGW25-M5

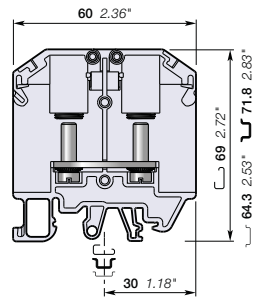

18 mm 0.709 in spacing

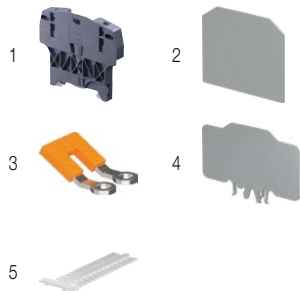

Description

- Stud terminal block for ring lug connection,
- Integrated captive nuts in protective wings provide easy and secured connection,
- Universal mounting on symmetrical and asymmetrical rails.

Ordering details

Description	Color	Type	Part Numbers	Pkg qty	Weight (1 pce) g
Feed-through With 2 studs M5 and captive nuts in wings	Grey <input type="checkbox"/>	RGW25-M5-V0	1SNA510005R0000	10	49.10

Main technical data

	IEC	UL	CSA
Lugs	Rigid: Solid/Stranded Flexible with insulated ferrule Gauge	0.1 ... 25 mm ² 0.1 ... 25 mm ²	26 ... 4 AWG 26 ... 4 AWG
Rated current	101 A	85 A	100 A
Maximum current		115 A	
Rated cross section	25 mm ²	4 AWG	4 AWG
Rated short-time withstand current (1s)	3000 A		
Rated voltage	800 V	600 V	600 V
Impulse withstand voltage	8000 V		
Protection	IP10	NEMA 1	

Mounting instructions

Rail		G32, TH 35-7.5, TH 35-15
Nuts		Flat screwdriver Ø 5.5 mm Ø 0.217 in
Tool		3 ... 3.5 N.m 26.5 ... 31 lb.in
Torque		16.2 mm 0.64 in
Max width of lug		

The connecting capacity data for one Rigid: Solid/Stranded, or one Flexible conductor (when applicable) is a mandatory information required by IEC, UL and CSA standards (Copper conductors). All other data are provided as supplementary information only. For more details, please consult our CB, UL or CSA certificates and technical datasheet available on <http://www.TE.com>

CE	RoHS	UL US	CSA

Accessories

Description	Color	Type	Part Numbers	Pkg qty	Weight (1 pce) g
1 End stops 10 mm 0.394 in	Dark grey <input type="checkbox"/>	BAZH1	1SNK900102R0000	20	24.00
2 End sections 1.4 mm 0.055 in	Grey <input type="checkbox"/>	E-RGW25	1SNA519005R0000	25	0.146
3 Lateral jumper bars 2 poles 101 A (IEC)	Orange <input type="checkbox"/>	PC-RG25-2	1SNA519106R0200	25	8.81
4 Circuit separators 2 mm 0.079 in	Grey <input type="checkbox"/>	CS-RGW-L	1SNA519201R0000	25	13.72
5 Terminal block markers	White <input type="checkbox"/>	M-W1010PC	1SNA235512R1000	200	0.10
		MG-CPM-01 41096	1SNB041096R0810	1120	0.400

Complete list of accessories is indicated in the terminal block datasheet including end stops.

Some accessories such as jumper bars may modify the terminal block's ratings: Complete information available in the accessories section of the catalog.

Technical data valid for copper conductors only.

RGW25-M6 Ring lug terminal blocks

Feed-through - 18 mm 0.709 in spacing

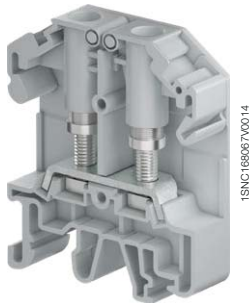
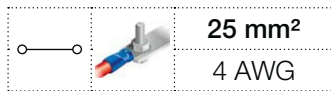

RGW25-M6

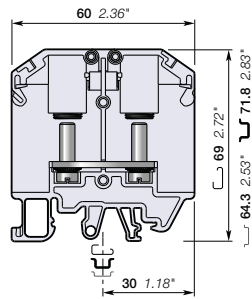

18 mm 0.709 in spacing

Description

- Stud terminal block for ring lug connection,
- Integrated captive nuts in protective wings provide easy and secured connection,
- Universal mounting on symmetrical and asymmetrical rails.

Ordering details

Description	Color	Type	Part Numbers	Pkg qty	Weight (1 pce) g
Feed-through With 2 studs M6 and captive nuts in wings	Grey <input type="checkbox"/>	RGW25-M6-V0	1SNA510006R0000	10	48.44

Main technical data

Lugs	Rigid: Solid/Stranded Flexible with insulated ferrule Gauge	IEC	UL	CSA
		0.1 ... 25 mm ²	26 ... 4 AWG	26 ... 4 AWG
Rated current		101 A	85 A	100 A
Maximum current			115 A	
Rated cross section	25 mm ²		4 AWG	4 AWG
Rated short-time withstand current (1 s)	3000 A			
Rated voltage	800 V		600 V	600 V
Impulse withstand voltage	8000 V			
Protection	IP10		NEMA 1	

Mounting instructions

Rail		G32, TH 35-7.5, TH 35-15
Nuts		Flat screwdriver Ø 5.5 mm Ø 0.217 in
Tool		
Torque		3.2 ... 3.5 N.m 28.3 ... 32.7 lb.in
Max width of lug		16.2 mm 0.64 in

The connecting capacity data for one Rigid: Solid/Stranded, or one Flexible conductor (when applicable) is a mandatory information required by IEC, UL and CSA standards (Copper conductors). All other data are provided as supplementary information only. For more details, please consult our CB, UL or CSA certificates and technical datasheet available on <http://www.TE.com>

CE	RoHS	UL US USH CNR	CSA

Accessories

Description	Color	Type	Part Numbers	Pkg qty	Weight (1 pce) g
1 End stops 10 mm 0.394 in	Dark grey <input type="checkbox"/>	BAZH1	1SNK900102R0000	20	24.00
2 End sections 1.4 mm 0.055 in	Grey <input type="checkbox"/>	E-RGW25	1SNA519005R0000	25	0.146
3 Lateral jumper bars 2 poles 101 A (IEC)	Orange <input type="checkbox"/>	PC-RGW25-2	1SNA519106R0200	25	8.81
4 Circuit separators 2 mm 0.079 in	Grey <input type="checkbox"/>	CS-RGW-L	1SNA519201R0000	25	13.72
5 Terminal block markers	White <input type="checkbox"/>	M-W1010PC	1SNA235512R1000	200	0.10
		MG-CPM-01 41096	1SNB041096R0810	1120	0.400

Complete list of accessories is indicated in the terminal block datasheet including end stops.

Some accessories such as jumper bars may modify the terminal block's ratings: Complete information available in the accessories section of the catalog.

Technical data valid for copper conductors only.



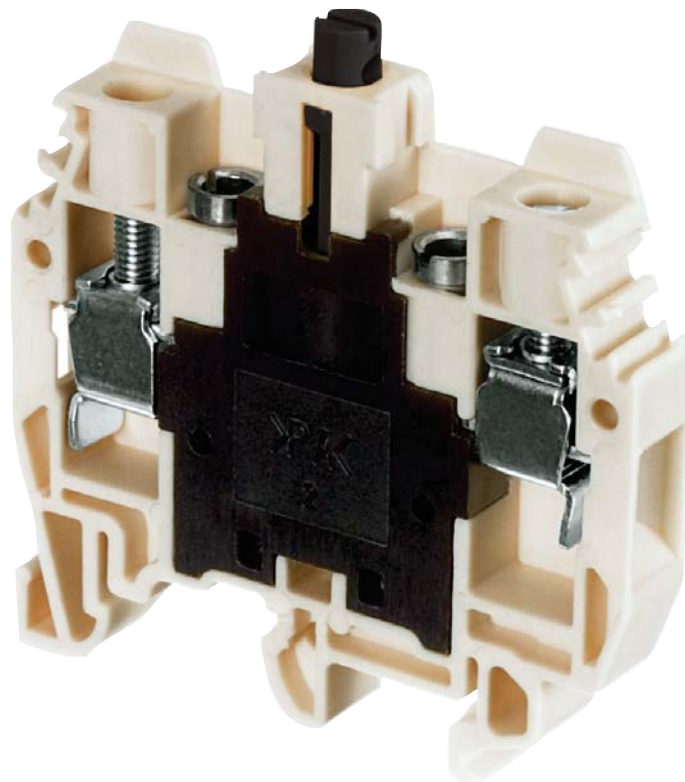

7

Railway applications, terminal blocks

Screw clamp technology complying with NF F 55251

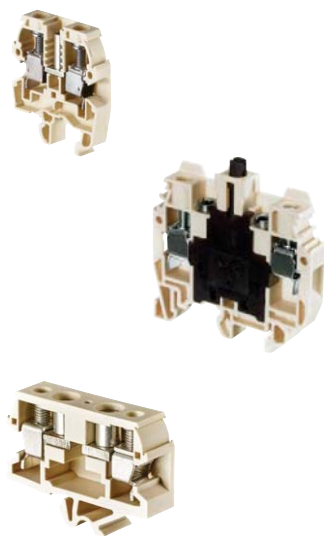

Technologies presentation	208
Overview	210

Feed-through

2.5 mm ²	E4/6	211
6 mm ²	E6/8	212
10 mm ²	E10/16	213

Disconnect with push-turn knob

6 mm ²	M6/8.STP	1/4 turn push-turn knob	214
	ES8-CG	1/4 turn push-turn knob - contact protected by dust cover	215

Disconnect with plug

10 mm ²	E10/16.S	216
--------------------	-----------------	-----

Railway applications, terminal blocks

Screw clamp technology complying with NF F 55251 and CT448



The proven reliability and performance for railway infrastructure

The screw clamp technology complying with NF F 55251 and CT448 minimizes maintenance & trouble shooting operations thanks to the anti-release system. The screw is locked in total safety.

The high density capacity screw clamp connection can fit up to two conductors per clamp which offers extended possibilities in electrical cabinets.



Reliable in harsh conditions

Excellent withstand in corrosive atmosphere

- Self-cleaning push-turn knob
- Stainless steel screw
- Nickered copper alloy compression clamp
- Dust protection covering.



Continuous operations

Maintenance and trouble shooting operations are minimized

- Thanks to our anti-release system
- Screw is locked in total safety.

Features

Focus on ES8-CG

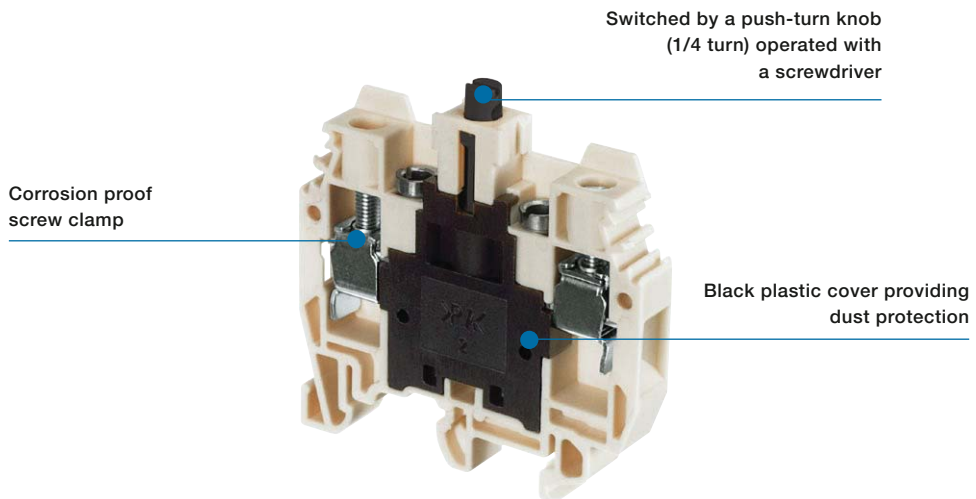
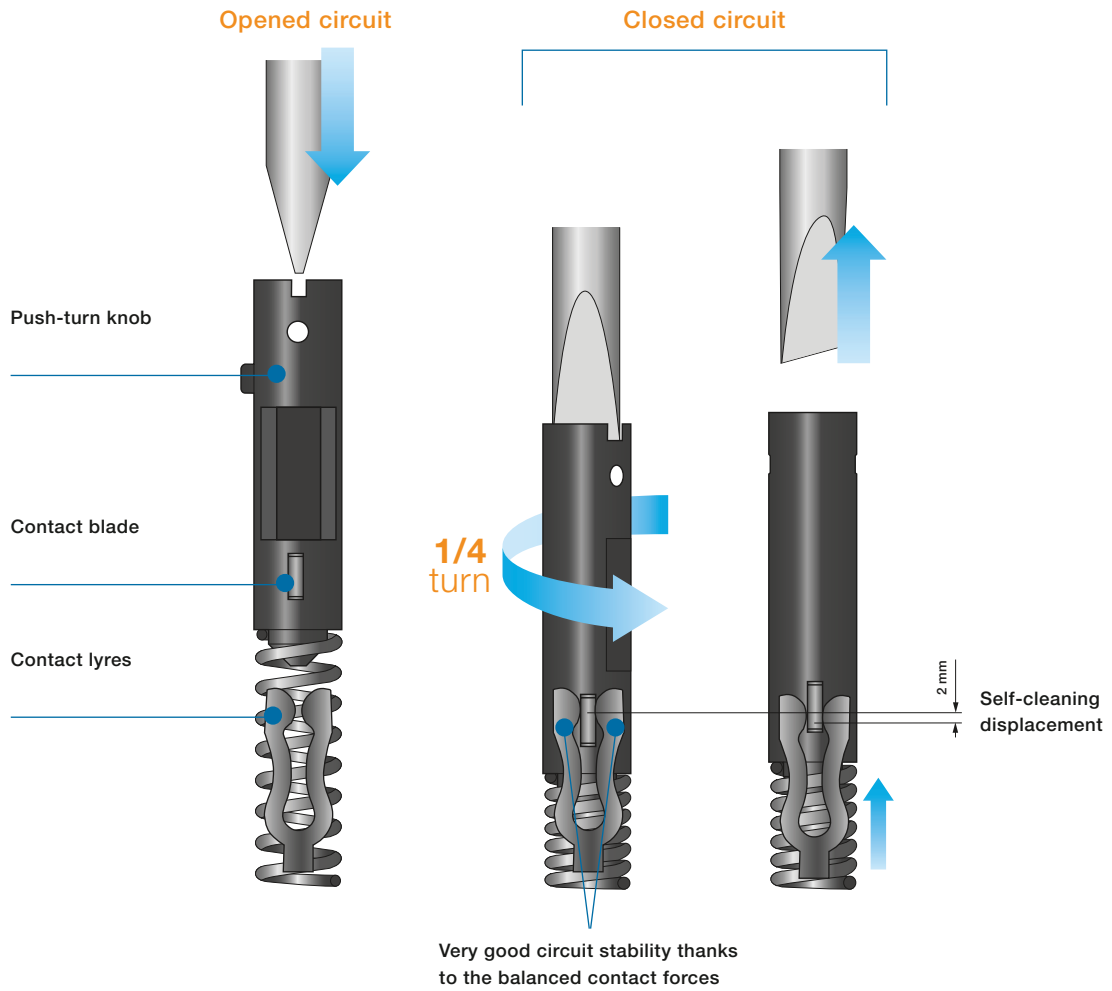

Railway applications, terminal blocks

Screw clamp and pluggable technologies



Feed-through

Section			
2.5 mm ²	E4/6	E6/8	E10/16
6 mm ²			
10 mm ²			

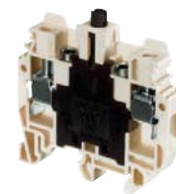

Disconnect with plug

Disconnect with push-turn knob

Section			
6 mm ²	E10/16.S	M6/8.STP	ES8-CG
10 mm ²			

Clamp -
 Channels for jumpering or testing -
 Test socket -
 Blown-fuse indicator

E4/6 railway terminal blocks

Feed-through - 6 mm 0.236 in spacing



E4/6

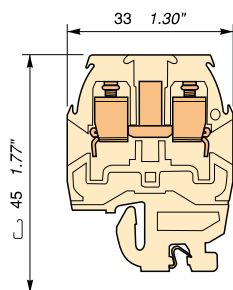

6 mm 0.236 in spacing

Description

- Ease your test operations with the built-in test socket - NF F 55-251 designation: ER 6,
- Sy SNCF 7 963 1088.

Ordering details

Description	Color	Type	Part Numbers	Pkg qty	Weight (1 pce) g
Feed-through With test socket DIA 2 mm 0.079 in	Beige	E4/6	1SNA190468R0000	50	8.00

Main technical data

Connecting capacity		NF C	DIN	NF F 55-251	Mounting instructions	
1 conductor per clamp	Rigid: Solid/Stranded	0.5 ... 4 mm ²			Rail	G32
	Flexible without ferrule	0.5 ... 2.5 mm ²			Wire stripping length	9.5 mm 0.374 in
					Tool	Flat screwdriver Ø 4 mm Ø 0.157 in
Rated voltage	V AC	500 V	750 V	500 V	Torque	0.5 - 0.8 N.m 4.43 - 7.08 lb.in
	V DC	500 V	900 V	500 V		
Rated current		30 A	26 A	30 A		
Rated cross section		2.5 mm ²	2.5 mm ²	2.5 mm ²		

--	--	--	--	--	--	--	--	--	--

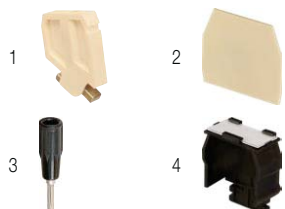

Accessories

Description	Color	Type	Part Numbers	Pkg qty	Weight (1 pce) g	
1 End stops 10 mm 0.394 in	Beige	BAR	1SNA164519R2400	50	11.00	
2 End sections 1 mm 0.039 in	Beige	FEE6-1	1SNA193080R1200	25	1.30	
3 Test plugs DIA 2 mm 0.079 in	Black	FC2	1SNA007865R2600	100	2.00	
4 Terminal block markers	Label holder	Black	PE	1SNA103007R2300	25	13.00
	Blank card	White	RC610	1SNA233000R0100	10	7.50

E6/8 railway terminal blocks

Feed-through - 8 mm 0.315 in spacing



6 mm²

Description

- Ease you test operations with the built-in test socket - NF F 55-251 designation: ER 8,
- Sy SNCF 7 963 1114.

Ordering details

Description	Color	Type	Part Numbers	Pkg qty	Weight (1 pce) g
Feed-through With test socket DIA 4 mm 0.157 in	Beige	E6/8	1SNA190607R0400	50	15.00

Main technical data

Connecting capacity		NF C	DIN	NF F 55-251	Mounting instructions	
1 conductor per clamp	Rigid: Solid/Stranded	0.5 ... 10 mm ²			Rail	G32
	Flexible without ferrule	0.5 ... 6 mm ²			Wire stripping length	13 mm 0.512 in
					Tool	Flat screwdriver Ø 5 mm Ø 0.197 in
Rated voltage	V AC	500 V	750 V	500 V	Torque	0.8 - 1 N.m 7.08 - 8.85 lb.in
	V DC	500 V	900 V	500 V		
Rated current		51 A	46 A	51 A		
Rated cross section		6 mm ²	6 mm ²	6 mm ²		

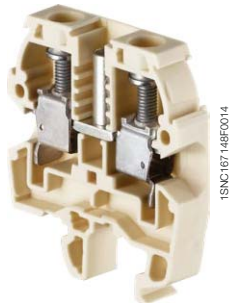

1SNC167148F0014

E6/8

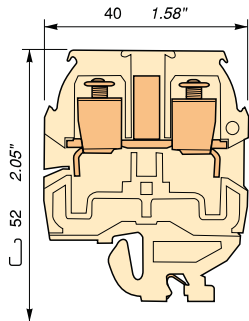

8 mm 0.315 in spacing

--	--	--	--	--	--	--	--	--	--

Accessories

Description	Color	Type	Part Numbers	Pkg qty	Weight (1 pce) g
1 End stops 10 mm 0.394 in	Beige	BAR	1SNA164519R2400	50	11.00
2 End sections 1 mm 0.039 in	Beige	FEE8-2	1SNA193085R0300	25	2.00
3 Lateral jumper bars 2 poles 50 A (IEC)	Black	PC8-2	1SNA116538R1700	10	3.00
		PC8-10	1SNA163313R2400	10	14.00
4 Test plugs DIA 4 mm 0.157 in	White	FC4	1SNA167860R0100	10	10.00
5 Terminal block markers Label holder	Black	PE	1SNA103007R2300	25	13.00
	White	RC810	1SNA234000R0200	10	8.20



E10/16 railway terminal blocks

Feed-through - 16 mm 0.63 in spacing

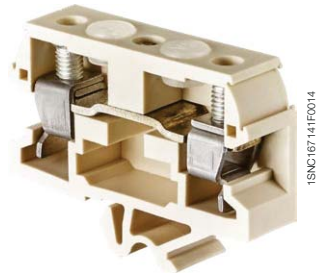

E10/16

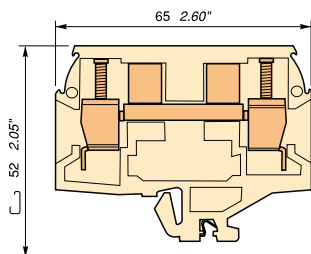

16 mm 0.63 in spacing

Description

- Ease your test operations with the built-in test socket - NF F 55-251 designation: ER 16,
- Sy SNCF 7 963 1110.

Ordering details

Description	Color	Type	Part Numbers	Pkg qty	Weight (1 pce) g
Feed-through With test socket DIA 4 mm 0.157 in	Beige	E10/16	1SNA191302R2700	25	47.00

Main technical data

Connecting capacity	NF C	DIN	NF F 55-251	Mounting instructions	
1 conductor per clamp	Rigid: Solid/Stranded Flexible without ferrule	0.5 ... 16 mm ² 0.5 ... 10 mm ²		Rail	G32
				Wire stripping length	14 mm 0.551 in
				Tool	Flat screwdriver Ø 5.5 mm Ø 0.217 in
Rated voltage	V AC V DC	750 V 500 V	750 V 900 V	500 V 500 V	
Rated current		71 A	63 A	71 A	
Rated cross section		10 mm ²	10 mm ²	10 mm ²	
				Torque	2.5 - 3 N.m 22.1 - 26.6 lb.in

	RoHS									
--	------	--	--	--	--	--	--	--	--	--



Accessories

Description	Color	Type	Part Numbers	Pkg qty	Weight (1 pce) g
1 End stops 10 mm 0.394 in	Beige	BAR	1SNA164519R2400	50	11.00
2 End sections 1.5 mm 0.059 in	Beige	FEE10-16	1SNA193449R2400	10	
3 Lateral jumper bars 2 poles		PC	1SNA168497R2300	10	7.00
4 Test plugs DIA 4 mm 0.157 in	White	FC4	1SNA167860R0100	10	10.00
5 Terminal block markers Label holder Blank card	Black White	PE RC1010	1SNA103007R2300 1SNA238000R1600	25 10	13.00 1.30

M6/8.STP railway terminal blocks

Disconnect with push-turn knob - 8 mm 0.315 in spacing

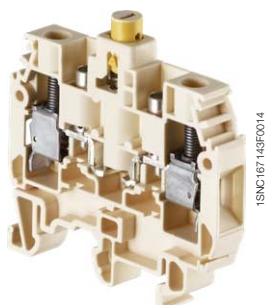

M6/8.STP

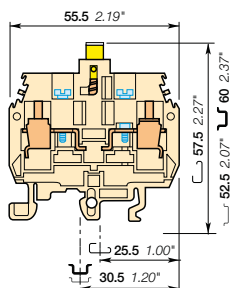

8 mm 0.315 in spacing

Description

- Ease your disconnect operations with the disconnect 1/4 turn push-turn knob,
- Possibility to seal in the open position,
- Ease your test operations with the built-in test socket,
- NF F 55-251 designation: ES 8,
- Sy SNCF 7 963 1156.

Ordering details

Description	Color	Type	Part Numbers	Pkg qty	Weight (1 pce)
Disconnect With 2 tests sockets DIA 4 mm 0.157 in	Beige	M6/8.STP	1SNA195212R1000	25	21.00

Main technical data

Connecting capacity	NF C	DIN	NF F 55-251
1 conductor per clamp	Rigid: Solid/Stranded Flexible without ferrule	0.5 ... 10 mm ² 0.5 ... 6 mm ²	
Rated voltage	V AC V DC	500 V 500 V	500 V 500 V
Rated current		17 A 15 A	12 A
Rated cross section		6 mm ² 6 mm ²	6 mm ²

Mounting instructions

Rail		G32, TH 35-7.5, TH 35-15
Wire stripping length		11 mm 0.433 in
Tool		Flat screwdriver Ø 4 mm Ø 0.157 in
Torque		0.8 - 1 N.m 7.08 - 8.85 lb.in

--	--	--

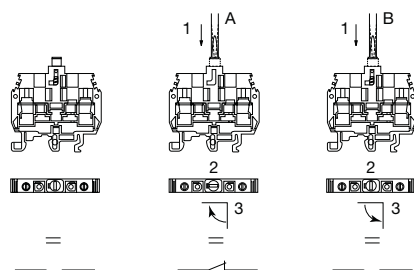

- A: Closing operation
B: Opening operation
1: Push
2: Turn
3: stop

Accessories

Description	Color	Type	Part Numbers	Pkg qty	Weight (1 pce)
1 End stops 10 mm 0.394 in	Beige	BAM2	1SNA296351R0000	50	12.00
2 End sections 2.8 mm 0.110 in	Beige	FEMT1	1SNA193137R0300	50	2.00
3 Lateral jumper bars 1 poles 24 A (IEC)	Grey	AD2.5	1SNA114205R2000	50	1.60
3 Lateral jumper bars 2 poles 50 A (IEC)	Black	PC8-2	1SNA116538R1700	10	3.00
3 Lateral jumper bars 10 poles 50 A (IEC)		PC8-10	1SNA163313R2400	10	14.00
4 Test plugs DIA 4 mm 0.157 in	White	FC4	1SNA167860R0100	10	10.00
5 Short circuit plugs With test socket DIA 4 mm 0.157 in	Beige	BNSTP1	1SNA196792R1700	20	14.00
6 Terminal block markers Blank card	White	RC810	1SNA234000R0200	10	8.20

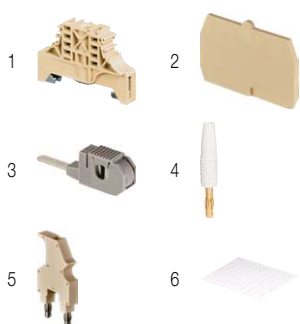

ES8-CG railway terminal blocks

Disconnect with push-turn knob - 8 mm 0.315 in spacing



6 mm²

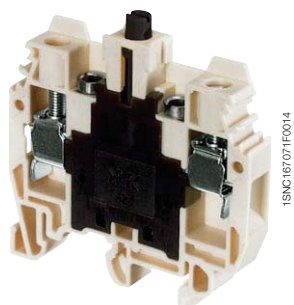

1SNC167071FC014

ES8-CG

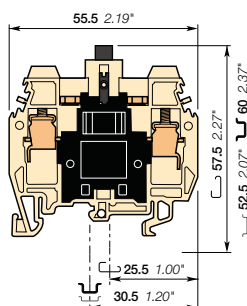

8 mm 0.315 in spacing

Description

- Particularly recommended for corrosive atmosphere: Self-cleaning displacement system and dust protection with plastic cover,
- Ease and safe your disconnect operations with the disconnect 1/4 turn push-turn knob,
- Possibility to seal in the open position,
- Ease your test operations with the built-in test socket.

Ordering details

Description	Color	Type	Part Numbers	Pkg qty	Weight (1 pce) g
Disconnect With 2 tests sockets DIA 4 mm 0.157 in	Beige	ES8-CG	1SNA400015R2000	25	21.00
	Green	ES8-CG	1SNA400014R2700	25	21.00

Main technical data

Connecting capacity		According to CT 448 of the IG PS 52		Mounting instructions	
1 conductor per clamp	Rigid/ Solid/Stranded	0.5 ... 10 mm ²	Rail		G32, TH 35-7.5, TH 35-15
	Flexible without ferrule	0.5 ... 6 mm ²	Wire stripping length		11 mm 0.433 in
			Tool		Flat screwdriver Ø 4 mm Ø 0.157 in
Rated voltage	V AC	500 V	Torque		0.8 - 1 N.m 7.08 - 8.85 lb.in
	V DC	500 V			
Rated current	2 A				
Rated cross section	6 mm ²				

CE	RoHS	EAC																	
CE	RoHS	EAC																	

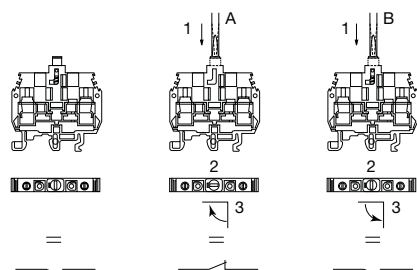

- A: Closing operation
- B: Opening operation
- 1: Push
- 2: Turn
- 3: stop

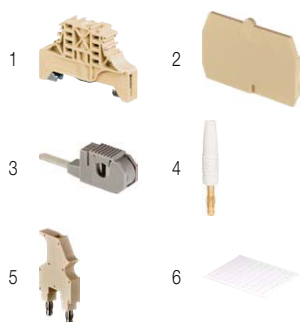

Accessories

Description	Color	Type	Part Numbers	Pkg qty	Weight (1 pce) g
1 End stops 10 mm 0.394 in	Beige	BAM2	1SNA296351R0000	50	12.00
		BAR	1SNA164519R2400	50	11.00
2 End sections 2.8 mm 0.110 in	Beige	FEMT1	1SNA193137R0300	50	2.00
3 Lateral jumper bars 1 poles 24 A (IEC)	Grey	AD2.5	1SNA114205R2000	50	1.60
	Black	PC8-2	1SNA116538R1700	10	3.00
		PC8-10	1SNA163313R2400	10	14.00
4 Test plugs DIA 4 mm 0.157 in	White	FC4	1SNA167860R0100	10	10.00
5 Short circuit plugs With test socket DIA 4 mm 0.157 in	Beige	BNSTP1	1SNA196792R1700	20	14.00
6 Terminal block markers Blank card	White	RC810	1SNA234000R0200	10	8.20

E10/16.S railway terminal blocks

Disconnect with plug - 16 mm 0.63 in spacing

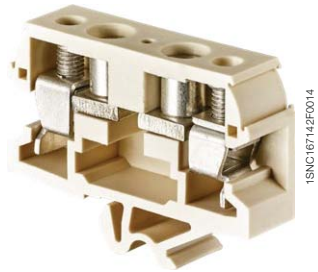

E10/16.S

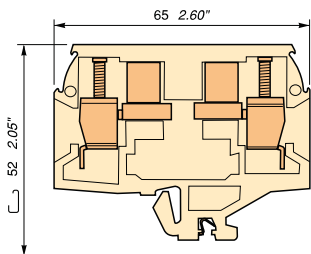

16 mm 0.63 in spacing

Description

- NF F 55-251 designation: ES 16,
- Sy SNCF 7 963 1109

Ordering details

Description	Color	Type	Part Numbers	Pkg qty	Weight (1 pce) g
Disconnect	Beige	E10/16.S	1SNA191296R1100	25	47.00

Main technical data

Connecting capacity		NF C	DIN	NF F 55-251	Mounting instructions	
1 conductor per clamp	Rigid: Solid/Stranded	0.5 ... 16 mm ²			Rail	G32
	Flexible without ferrule	0.5 ... 10 mm ²			Wire stripping length	14 mm / 0.551 in
					Tool	Flat screwdriver Ø 5.5 mm / Ø 0.217 in
Rated voltage	V AC	500 V	380 V	500 V	Torque	2.5 - 3 N.m / 22.1 - 26.6 lb.in
	V DC	500 V	440 V	500 V		
Rated current				30 A		
Rated cross section		10 mm ²	10 mm ²	10 mm ²		

--	--	--	--	--	--	--	--	--	--



Accessories

Description	Color	Type	Part Numbers	Pkg qty	Weight (1 pce) g
1 End stops 10 mm 0.394 in	Beige	BAR	1SNA164519R2400	50	11.00
2 End sections 1.5 mm 0.059 in	Beige	FEE10-16	1SNA193449R2400	10	
3 Lateral jumper bars 2 poles		PC	1SNA168497R2300	10	7.00
5 Guide plugs	Beige	BIE	1SNA196915R0200	25	36.00
4 Component plugs	Black	SSB20	1SNA103098R2600	20	15.00
		SSB20T	1SNA103099R2700	20	17.00
6 Short circuit plugs With test socket DIA 4 mm 0.157 in	Beige	BNSTP1	1SNA196792R1700	20	14.00
7 Terminal block markers	Black	PE	1SNA103007R2300	25	13.00
	White	RC1010	1SNA238000R1600	10	1.30





Railway applications, terminal blocks

Screw clamp technology

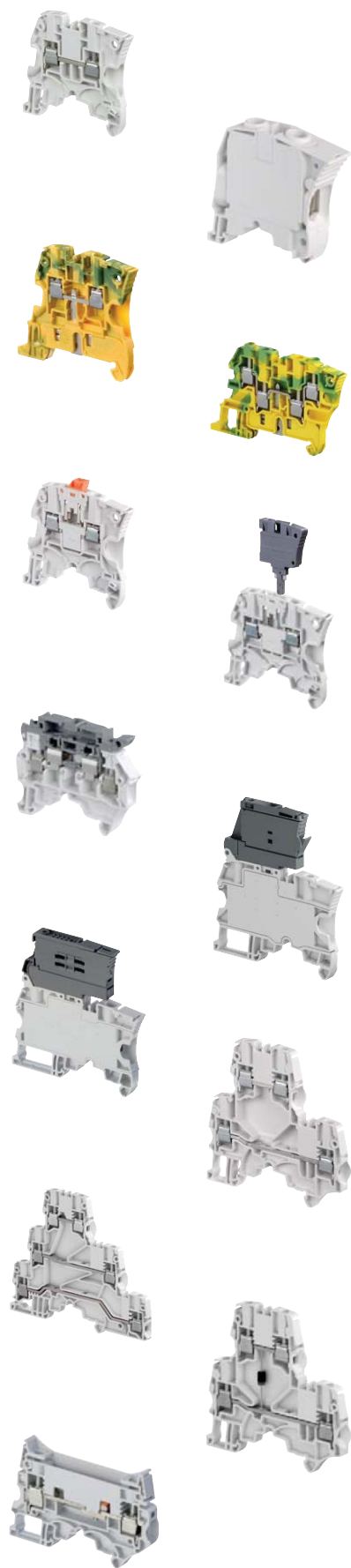

Technologies presentation		220
Overview		224
Feed-through		
4 mm ² / 12 AWG	ZS4	228
6 mm ² / 10 AWG	ZS6	229
	ZS6-3S and ZS6-4S	with 3 and 4 connections 230-231
10 mm ² / 6 AWG	ZS10	232
16 mm ² / 4 AWG	ZS16	233
25 mm ² / 3 AWG	ZS25	234
35 mm ² / 0 AWG	ZS35	235
50 mm ² / 0 AWG	ZS50	236
70 mm ² / 00 AWG	ZS70	237
95 mm ² / 0000 AWG	ZS95	238
150 mm ² / 350 Kcmil	ZS150	239
240 mm ² / 500 Kcmil	ZS240	240
Ground		
4 mm ² / 12 AWG	ZS4-PE	241
6 mm ² / 10 AWG	ZS6-PE	242
	ZS6-3S-PE and ZS6-4S-PE	with 3 and 4 connections 243-244
10 mm ² / 6 AWG	ZS10-PE	245
16 mm ² / 4 AWG	ZS16-PE	246
25 mm ² / 3 AWG	ZS25-PE	247
35 mm ² / 2 AWG	ZS35-PE	248
35 mm ²	ZS35-PEN	+ neutral 249
50 mm ² / 0 AWG	ZS50-PE	250
70 mm ² / 00 AWG	ZS70-PE	251
95 mm ² / 0000 AWG	ZS95-PE	252
Disconnect with blade		
4 mm ² / 10 AWG	ZS4-S, ZS4-S-T, ZS4-S-R1 and ZS4-S-T-R1	with test 253-256
6 mm ² / 10 AWG	ZS6-S and ZS6-S-4S-T	with test 257-258
10 mm ² / 6 AWG	ZS10-S	259
Disconnect with plug		
4 mm ² / 10 AWG	ZS4-SP, ZS4-SP-T2, ZS4-SP-R1 and ZS4-SP-T2-R1	with test 260-263
10 mm ² / 6 AWG	ZS10-SP	264
Fuse and marshalling cabinets application overview		
		266
For 5x20 and 5x25 mm fuses		
4 mm ² / 10 AWG	ZS4-SF1 and ZS4-SF1-T	with test 268-269
	ZS4-SF1-R	with fuse indicator and test 270-271
	ZS4-R1	feed-through 272
	ZS4-S-R3	disconnect with lever 273
For 5x20 mm fuses and marshalling cabinets application		
4 mm ² / 10 AWG	ZS4-SF	274
	ZS4-SF-T	with test 275
	ZS4-SF-R	with fuse indicator and test 276-277
	ZS4-R2	feed-through 278
	ZS4-PE-R2	ground 279
	ZS4-S-R2	disconnect with lever 280
For 6.3x32 mm fuses (¼ x 1¼ in)		
10 mm ² / 6 AWG	ZS10-SF	281
	ZS10-SF-R	with fuse indicator 282
	ZS10-S-R2	disconnect with lever 283
Double deck		
4 mm ² / 12 AWG	ZS4-D2 and ZS4-D1	2 and 1 feed-through circuits 284-285
6 mm ² / 10 AWG	ZS6-D2 and ZS6-D1	2 and 1 feed-through circuits 286-287
	ZS6-D2-PE	1 feed-through circuit and 1 ground circuit 288
	ZS6-D1-PE	1 ground circuit 289
4 mm ² / 10 AWG	ZS4-D2-S	1 disconnect circuit and 1 feed-through circuit 290
	ZS4-D2-S-T	1 disconnect circuit + test and 1 feed-through circuit 291
	ZS4-D2-SF1	1 fuse circuit and 1 feed-through circuit 292
	ZS4-D2-SF1-R	1 fuse circuit + fuse indicator and 1 feed-through circuit 293
Triple deck		
4 mm ² / 12 AWG	ZS4-T3	3 feed-through circuits 294
4 mm ² / 10 AWG	ZS4-T3-R1	3 feed-through circuits 295
Component holder		
4 mm ² / 12 AWG	ZS4-D-CH-UD and ZS4-D-CH-DU	296-297
Test and measurement		
Overview		
10 mm ² / 6 AWG	ZS10-ST	302
	ZS10-ST-1	for Potential Transformer circuits 303
	ZS10-ST-T4	for Current Transformer circuits 304
	ZS10-R1	feed-through 305
	ZS10-PE-R1	ground 306

Screw clamp technology - SNK series, terminal blocks

Features and benefits

TE Connectivity screw clamp technology benefits from 60 years of experience.

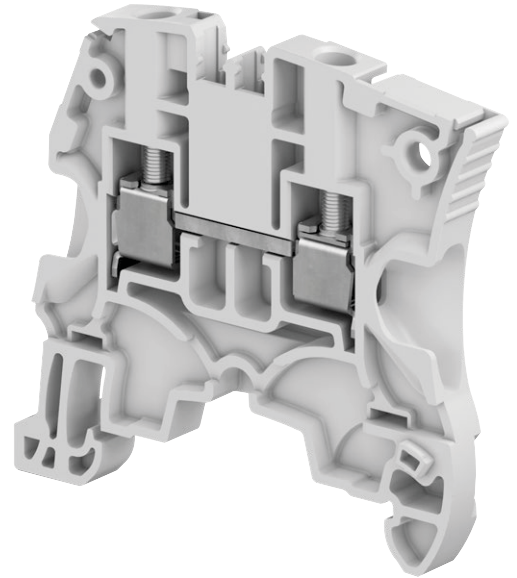

Speed up your projects

An optimized conductor guiding

Smooth connection process up to 2 conductors with or without ferrules thanks to funnel entry shape.

Also perfectly adapted to double ferrule shape **1**

Security: flap avoiding the insertion of cable underneath the clamp **2**.

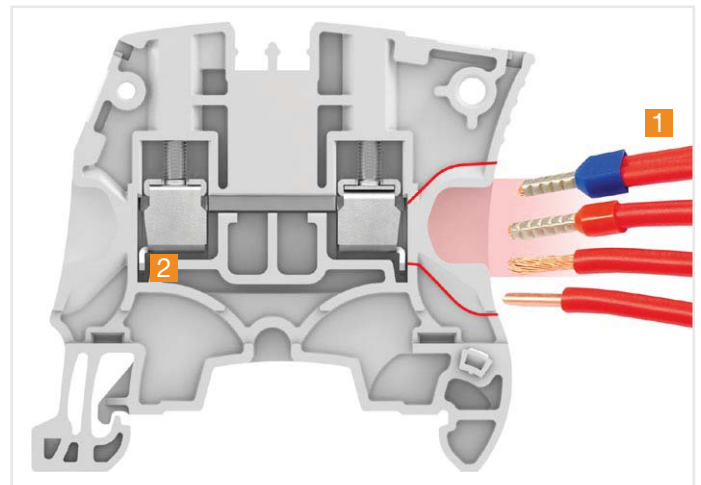

Engineered conductor entry

Better project identification

- Circuit identification is improved thanks to the 20% larger marking area
- Pre-mark by hand or with label on our flat marking surface and start immediately the wiring, before the final markers mounting
- Spare markers re-printing in case of modifications.

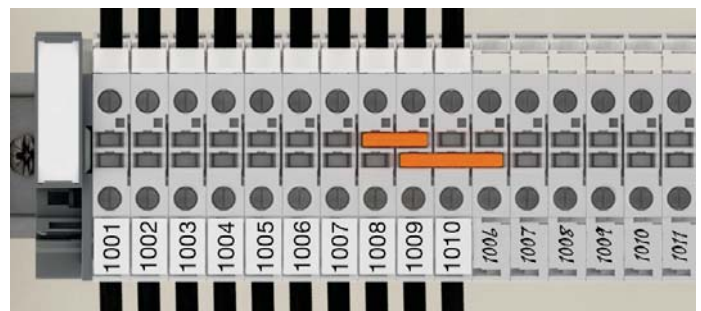

Clear circuit identification

1SNK161092S0201

Screw clamp technology - SNK series, terminal blocks

Features and benefits

Easy to install

Smart design facilitating assembly process.

Mounting, wiring, testing... made easy.

Avoid mounting and wiring errors: asymmetrical design allows immediate visual check in case of reversed terminal blocks.

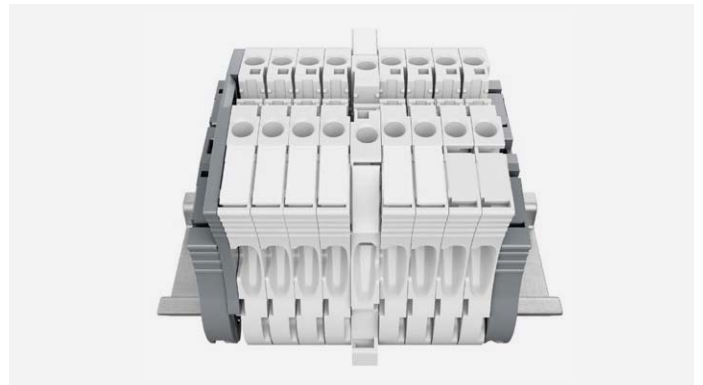

Asymmetrical design avoids mounting error

Minimize retightening campaigns

High torque resistance : the clamp is punched to increase the number of threads in contact by 30 % **1**.

The TE Connectivity exclusive anti-release system creates a controlled locking-screw effect reinforced by the 2 overlapping tabs that maintain the clamp parts **2**.

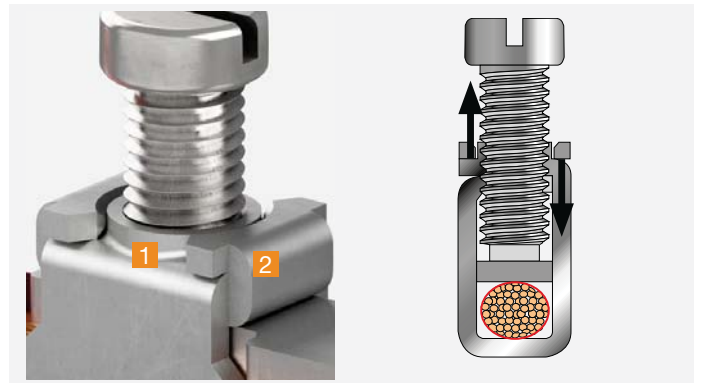

High torque resistance

Anti-release system

Faster accessories mounting

Save up to 70% mounting time thanks to screwless accessories: jumpers, component plugs, test devices, end stops and snap-in ground terminal blocks.

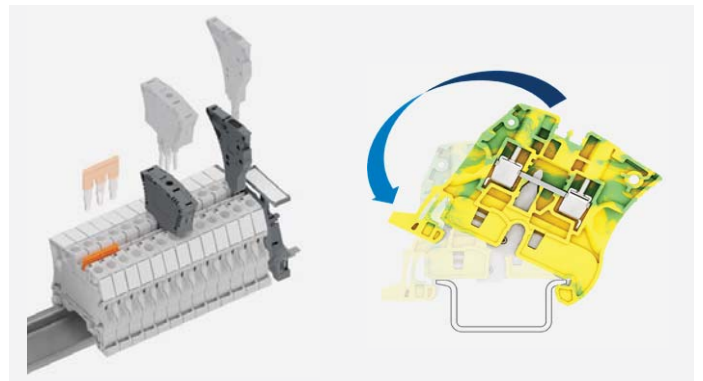

Screwless accessories

Snap-in ground terminal block for rapid installation

Screw clamp technology - SNK series, terminal blocks

Features and benefits

Easy to install

Smart design facilitating assembly process.

Mounting, wiring, testing... made easy.

Locking pin **1** allows quick and easy lock up to ten blocks in position at a time.

Closed jumper location allows great stiffness of the terminal block, optimal jumper guiding and avoids deflections while tightening.

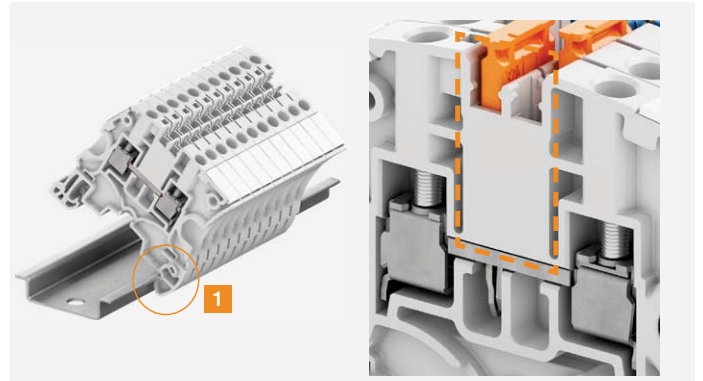

Lock up to ten blocks in position at a time

Closed jumper location for stiffness at a time

Smart accessories

Flexible test solutions from individual insulated test adapter to test connectors for complete assemblies testing.

- Direct plug-in into jumpers channels
- 5, 6, 8 mm spacing, mixing various spacing is possible
- 1000 V rating.

Component holder plugs for series or parallel component mounting (resistors, filters, diodes..).

Can be installed after wiring.

Series plug offers screwless component connection (no soldering).



Plug-in individual test adapter

Plug-in test connector



Series plug associated with disconnect blocks

Parallel plug to be installed between 2 blocks

Smart plug-in jumpers:

Pre-cut poles removable by hand: clean cut.

Insulated up to 1000 V (avoid use of separators).

Predefined shapes in molding to easily identify connected poles with a pen.

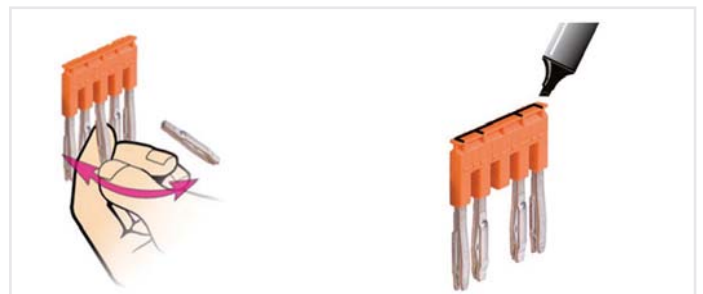

Pre-cut poles easy removable by hand

Predefined shape to identify connected poles

1SNK161092S0201

Screw clamp technology - SNK series, terminal blocks

Features and benefits

Optimized logistics

Reduce your accessories inventory by up to 50%

SNK PI-Spring, screw and pluggable ranges share the same accessories.

Reduced packaging adapted to the usage (20 items packaging for some references).

All end sections and circuit separators fit several types and sizes of blocks.

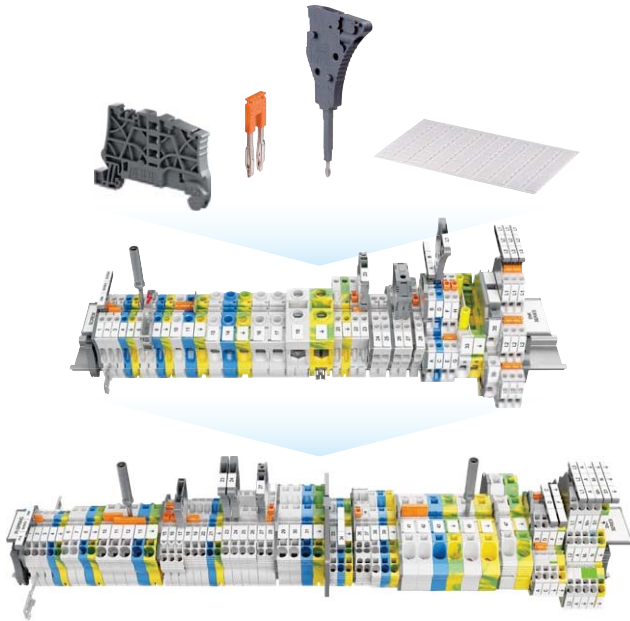

Shared accessories for SNK PI-Spring, screw and pluggable ranges

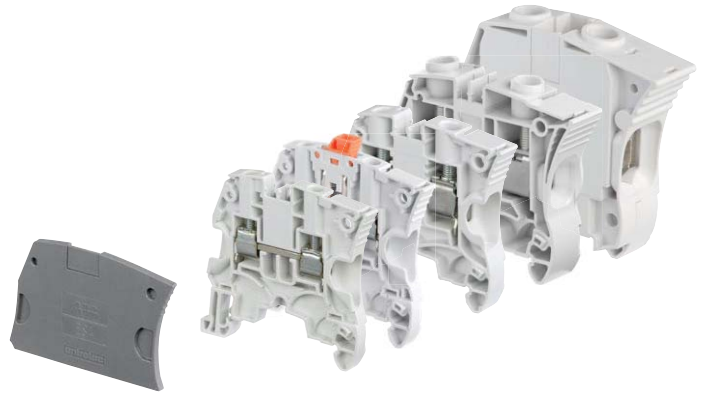

Stock only one end section for managing your assembly up to 240 mm²

Facilitate maintenance operations

Terminals can be individually removed from a terminal assembly equipped with markers:

TE Connectivity markers become independent after strip mounting, TE Connectivity markers remain on terminal in any situation.

Reliable in harsh conditions

Qualified for worldwide markets, applications and for severe environments: vibration, shock, corrosion...

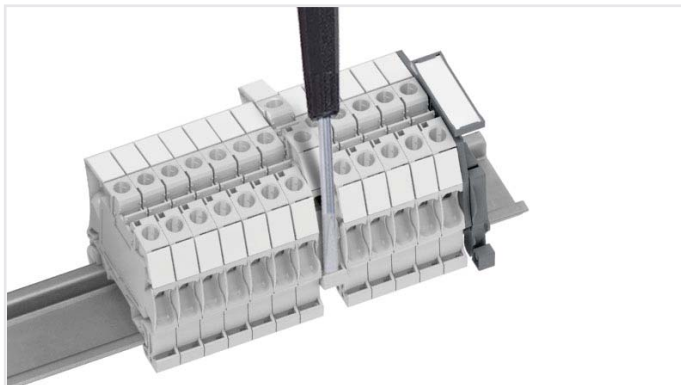

Maintenance operations facilitated



SNK series, terminal blocks

Screw clamp technology - Range overview from 4 to 240 mm² - 12 to 500 Kcmil



Connections

Single deck

Feed-through
Ground
Disconnect
Fuse



Connections

Single deck

Feed-through
Ground



Connections

Single deck

Feed-through
Ground
Disconnect

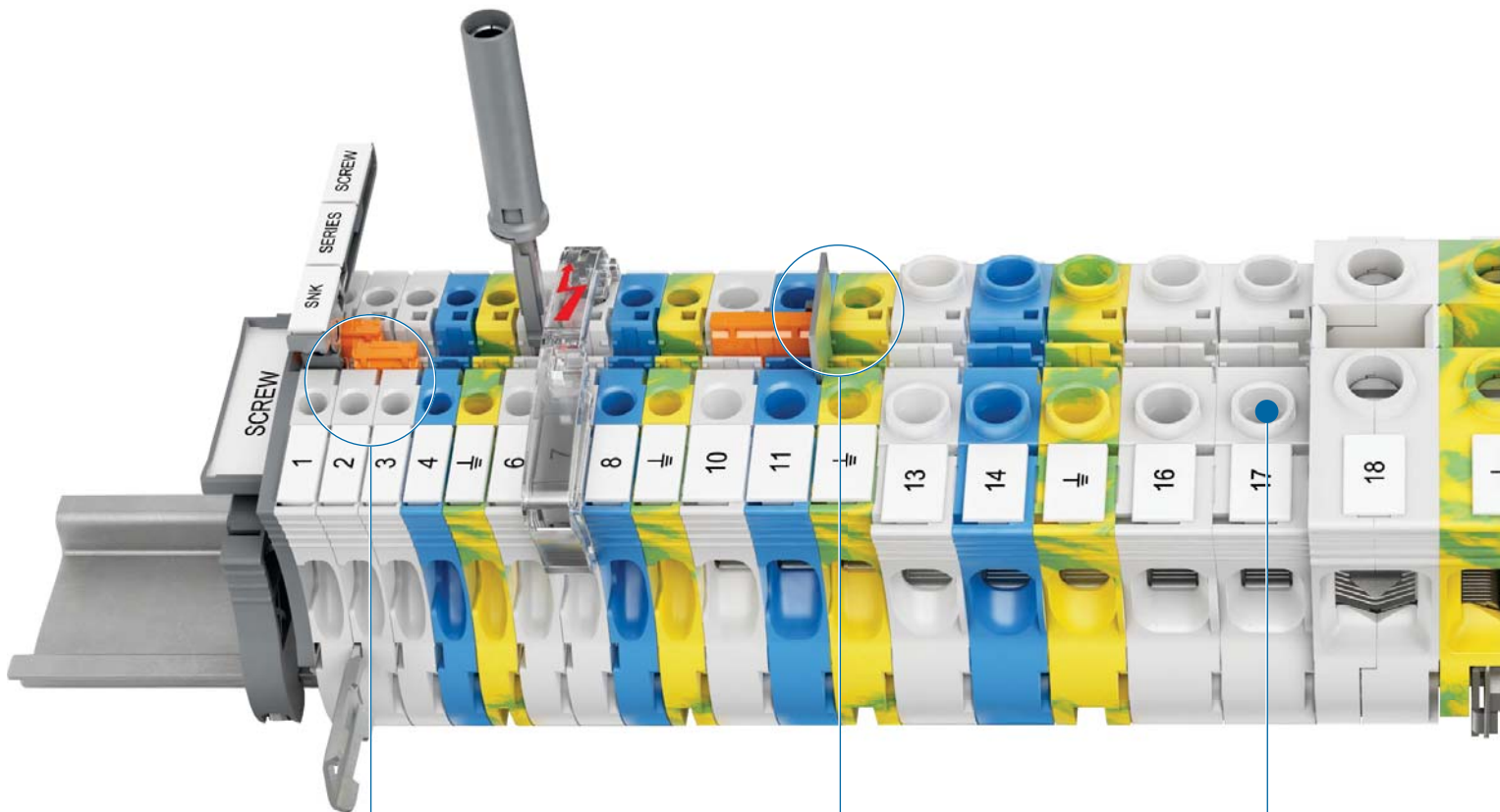

Double central channels

allows
multiconfigurations
(jumping, testing
and measuring)

Circuit separator
without spacing loss

Voltage test
screwdriver entry
point accepts
Category II probes

2x2  Connections

- Double deck**
- Feed-through
- Ground
- Disconnect
- Fuse
- Component holder

2  Connections

- Test and measurement**
- Feed-through
- Ground
- Disconnect

3x2  Connections

- Triple deck**
- Feed-through

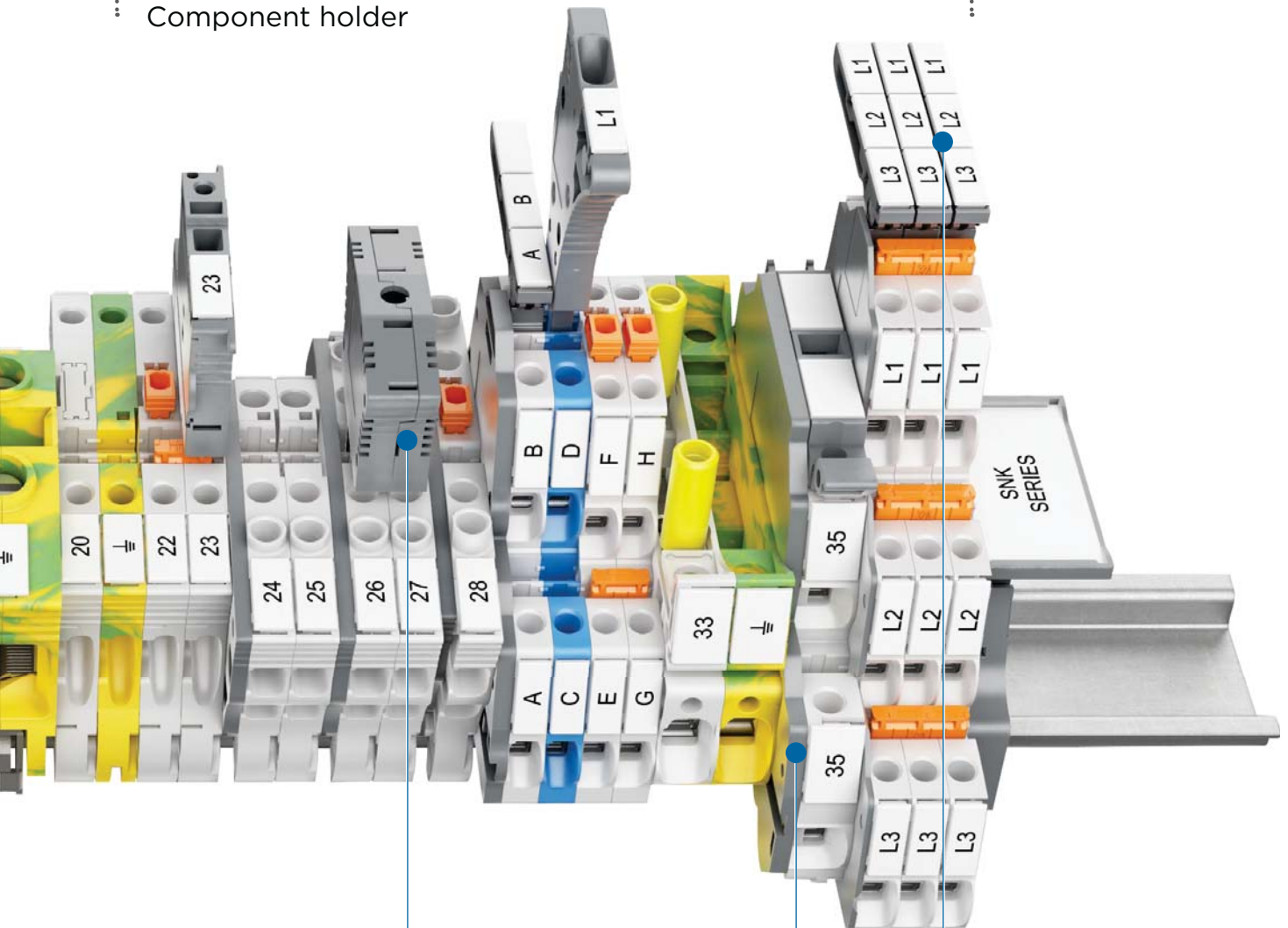

Plug
component holder

End section
can be used
as circuit separator

**Rotating label
holder**
easy plug-in in
jumper channel

SNK series, terminal blocks

Screw clamp technology



Feed-through

Ground

Section									
4 mm ²	12 AWG 10 AWG	ZS4					ZS4-PE		
6 mm ²	10 AWG	ZS6	ZS6-3S	ZS6-4S			ZS6-PE	ZS6-3S-PE	ZS6-4S-PE
10 mm ²	6 AWG	ZS10					ZS10-PE		
16 mm ²	4 AWG	ZS16					ZS16-PE		
25 mm ²	3 AWG	ZS25					ZS25-PE		
35 mm ²	0 AWG				ZS35				ZS35-PE
50 mm ²	0 AWG				ZS50				ZS50-PE
70 mm ²	00 AWG				ZS70				ZS70-PE
95 mm ²	0000 AWG				ZS95				ZS95-PE
150 mm ²	350 Kcmil					ZS150			
240 mm ²	500 Kcmil					ZS240			



Disconnect with blade

Disconnect with plug

Section										
4 mm ²	10 AWG	ZS4-S	ZS4-S-T2		ZS4-S-R1	ZS4-S-T2-R1 ZS4-S-T2.3-R1	ZS4-SP	ZS4-SP-T2	ZS4-SP-R1	ZS4-SP-T2-R1
6 mm ²	10 AWG	ZS6-S		ZS6-S-4S-T2						
10 mm ²	6 AWG	ZS10-S					ZS10-SP			



For 5 x 20 mm fuses

Aligned for marshalling cabinets application

For 6.3 x 32 mm fuses (¼ x 1¼ in)

Aligned

Section									
4 mm ²	10 AWG	ZS4-SF	ZS4-SF-T2	ZS4-SF-R1 ZS4-SF-R3	ZS4-SF-R2 ZS4-SF-R4	ZS4-R2	ZS4-PE-R2	ZS4-S-R2	
10 mm ²	6 AWG							ZS10-SF	ZS10-SF-R1 ZS10-SF-R3
									ZS10-S-R2

Clamp -
 Channels for jumpering or testing -
 Test socket -
 Blown-fuse indicator



Double deck						Triple deck				
Feed-through		Ground		Disconnect with blade		For 5 x 20 mm and 5 x 25 mm fuses		Component holder		Feed-through
ZS4-D2	ZS4-D1	ZS6-D2-PE	ZS6-D1-PE	ZS4-D2-S	ZS4-D2-S-T2	ZS4-D2-SF1	ZS4-D2-SF1-R1 ZS4-D2-SF-R3	ZS4-D-CH-UD	ZS4-D-CH-DU	ZS4-T3 ZS4-T3-R1



Test & measurement			
Test disconnect with sliding link		Aligned with ZS10-ST	
ZS10-ST	ZS10-ST-T4 ZS10-ST-1	ZS10-R1	ZS10-PE-R1



For 5 x 20 mm and 5 x 25 mm fuses				Feed-through aligned with ZS4-SF1	
ZS4-SF1	ZS4-SF1-T2	ZS4-SF1-R1 ZS4-SF1-R3	ZS4-SF1-R2 ZS4-SF1-R4	ZS4-R1	ZS4-S-R3

ZS4 screw clamp terminal blocks

Feed-through - 5.2 mm 0.205 in spacing



1SNK161001E0014

ZS4

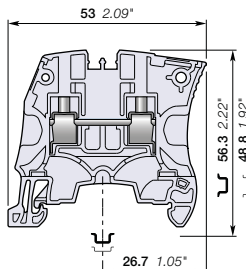

5.2 mm 0.205 in spacing

Description

- Save space by connecting conductors up to 4 mm² (without insulated ferrule, CB certified) 12 AWG in just 5.2 mm 0.205 in spacing,
- Perfectly adapted to solar applications: voltage is rated 1000 V AC / DC IEC.

Ordering details

Description	Color	Type	Part Number	Pkg qty	Weight (1 pce) g
Feed-through	Grey	ZS4	1SNK505010R0000	50	8.80
	Blue	ZS4-BL	1SNK505020R0000	50	8.80
	Orange	ZS4-OR	1SNK505030R0000	50	8.80
	Yellow	ZS4-YL	1SNK505060R0000	50	8.80
	Green	ZS4-GN	1SNK505061R0000	50	8.80
	Red	ZS4-RD	1SNK505062R0000	50	8.80
	Purple	ZS4-PR	1SNK505063R0000	50	8.80
	Brown	ZS4-BR	1SNK505064R0000	50	8.80
	White	ZS4-WH	1SNK505065R0000	50	8.80
	Black	ZS4-BK	1SNK505066R0000	50	8.80

Main technical data

Connecting capacity	IEC	UL - CSA	Rail	Wire stripping length	TH 35-7.5, TH 35-15
1 conductor per clamp	Rigid: Solid/Stranded	0.2 ... 4 mm ²	24 ... 12 AWG	10.5 mm	0.412 in
	Flexible without ferrule	0.22 ... 4 mm ²	24 ... 12 AWG		
	Flexible with non insulated ferrule	0.22 ... 4 mm ²	24 ... 12 AWG		
	Flexible with insulated ferrule	0.22 ... 2.5 mm ²	24 ... 14 AWG		
	Gauge	A3-B3			
2 conductors per clamp	Rigid: Solid/Stranded	0.2 ... 1.5 mm ²	24 ... 16 AWG	Flat screwdriver	Ø 3.5 mm
	Flexible without ferrule	0.2 ... 1.5 mm ²	24 ... 16 AWG		
	Flexible with twin ferrule	0.22 ... 1.5 mm ²	20 A / 12 AWG		
Rated current / Rated cross section	32 A / 4 mm ²	20 A / 12 AWG	Torque	0.6 Nm ± 0.1	5.31 lb.in ± 0.885
Rated short-time withstand current (1s)	480 A				
Short Circuit Current Rating (with specific conditions)		100 kA			
Rated voltage	1000 V	600 V			
Impulse withstand voltage	8000 V				
Protection	IP20	NEMA 1			
Increased safety Ex e	693 V 32 A IEC/EN 60079-7 - IM2 II 2 GD Ex eb I/IIIC - 600 V 20 A UL 60079-7 - Class I, Zone 1, AEx e II, Ex e II U				

The connecting capacity data for one Rigid: Solid/Stranded, or one Flexible conductor (when applicable) is a mandatory information required by IEC, UL and CSA standards (Copper conductors). All other data are provided as supplementary information only. For more details, please consult our CB, UL or CSA certificates and technical datasheet available on <http://www.TE.com>



Accessories

Description	Color	Type	Part Number	Pkg qty	Weight (1 pce) g	
1 End stops	Dark grey	BAM4	1SNK900001R0000	50	14.00	
2 End sections	Dark grey	ES4	1SNK505910R0000	20	2.20	
3 Jumper bars	Orange	2 poles	JB5-2	1SNK905302R0000	50	1.30
		3 poles	JB5-3	1SNK905303R0000	50	2.00
		4 poles	JB5-4	1SNK905304R0000	50	2.70
		5 poles	JB5-5	1SNK905305R0000	50	3.50
		10 poles	JB5-10	1SNK905310R0000	30	7.10
4 Cross spacing jumpers	Orange	JB85-3	1SNK900603R0000	10	2.80	
5 Circuit separators	Dark grey	0 mm	CS	1SNK900101R0000	20	0.20
		3 mm	CS-R1	1SNK900103R0000	20	5.20
6 Test adapters	Dark grey	For test plugs DIA 2 mm 0.079 in	TP2	1SNK900203R0000	20	1.70
		For test plugs DIA 4 mm 0.157 in	TP4	1SNK900205R0000	20	2.40
7 Test connectors	Dark grey	5.2 mm 0.205 in spacing	TC5	1SNK900200R0000	10	5.20
		End module, 5.2 mm 0.205 in	TC5-R1	1SNK900201R0000	10	5.20
8 Shield connectors		SHBS	1SNK900600R0000	20	3.50	
9 Protecting covers	Transparent	5.2 mm 0.205 in spacing	PL5	1SNK900618R0000	10	1.50
			MG-CPM 13 41790	1SNB041790R0512	1960	0.23
10 Terminal block markers	White	Blank marker	MC512	1SNK140000R0000	22	9.00
		Blank card	MC512PA	1SNK149999R0000	20	10.00
		Universal wire markers holder	UMH	1SNK900611R0000	10	0.20

Complete list of accessories is indicated in the terminal block datasheet including end stops.

Some accessories such as jumper bars may modify the terminal block's ratings: Complete information available in the accessories section of the catalog.

Ground screw clamp terminal blocks

Description	Color	Type	Part Number	Pkg qty	Weight (1 pce) g
Ground	Green-yellow	ZS4-PE	1SNK505150R0000	20	12.10

Technical data valid for copper conductors only.

ZS6 screw clamp terminal blocks

Feed-through - 6 mm 0.236 in spacing



ZS6

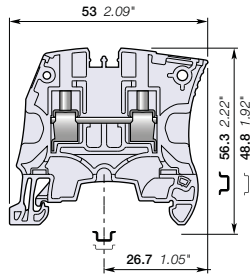

6 mm 0.236 in spacing

Description

Save space by connecting conductors up to 6 mm² (without insulated ferrule, CB certified) 10 AWG in just 6 mm 0.236 in spacing,

– Perfectly adapted to solar applications: voltage is rated 1000 V AC / DC IEC.

Ordering details

Description	Color	Type	Part Number	Pkg qty	Weight (1 pce) g
Feed-through	Grey	ZS6	1SNK506010R0000	50	10.60
	Blue	ZS6-BL	1SNK506020R0000	50	10.60
	Orange	ZS6-OR	1SNK506030R0000	50	10.60
	Yellow	ZS6-YL	1SNK506060R0000	50	10.60
	Green	ZS6-GN	1SNK506061R0000	50	10.60
	Red	ZS6-RD	1SNK506062R0000	50	10.60
	Purple	ZS6-PR	1SNK506063R0000	50	10.60
	Brown	ZS6-BR	1SNK506064R0000	50	10.60
	White	ZS6-WH	1SNK506065R0000	50	10.60
	Black	ZS6-BK	1SNK506066R0000	50	10.60

Main technical data

Connecting capacity	IEC	UL - CSA	Mounting instructions
1 conductor per clamp	Rigid: Solid/Stranded	0.2 ... 6 mm ²	24 ... 10 AWG
	Flexible without ferrule	0.2 ... 6 mm ²	
	Flexible with non insulated ferrule	0.22 ... 4 mm ²	24 ... 12 AWG
	Flexible with insulated ferrule	0.22 ... 4 mm ²	24 ... 12 AWG
	Gauge	A4-B3	
2 conductors per clamp	Rigid: Solid/Stranded	0.2 ... 2.5 mm ²	24 ... 14 AWG
	Flexible without ferrule	0.2 ... 2.5 mm ²	
	Flexible with twin ferrule	0.22 ... 2.5 mm ²	24 ... 14 AWG
Rated current / Rated cross section	41 A / 6 mm ²	30 A / 10 AWG	
Rated short-time withstand current (1s)	720 A		
Short Circuit Current Rating (with specific conditions)		100 kA	
Rated voltage	1000 V	600 V	
Impulse withstand voltage	8000 V		
Protection	IP20	NEMA 1	

Increased safety Ex e 693 V 41 A IEC/EN 60079-7 - IM2 II 2 GD Ex eb I/II/III - 600 V 30 A UL 60079-7 - Class I, Zone 1, AEx e II, Ex e II U

The connecting capacity data for one Rigid: Solid/Stranded, or one Flexible conductor (when applicable) is a mandatory information required by IEC, UL and CSA standards (Copper conductors). All other data are provided as supplementary information only. For more details, please consult our CB, UL or CSA certificates and technical datasheet available on <http://www.TE.com>



Accessories

Description	Color	Type	Part Number	Pkg qty	Weight (1 pce) g	
1 End stops	Dark grey	BAM4	1SNK900001R0000	50	14.00	
2 End sections	Dark grey	ES4	1SNK505910R0000	20	2.20	
3 Jumper bars	Orange	2 poles	JB6-2	1SNK906302R0000	50	1.30
		3 poles	JB6-3	1SNK906303R0000	50	2.10
		4 poles	JB6-4	1SNK906304R0000	50	2.90
		5 poles	JB6-5	1SNK906305R0000	50	3.60
		10 poles	JB6-10	1SNK906310R0000	20	7.40
		50 poles	JB6-50	1SNK906350R0000	10	38.10
4 Cross spacing jumpers	Orange	JB85-3	1SNK900603R0000	10	2.80	
5 Circuit separators	Dark grey	0 mm	CS	1SNK900101R0000	20	0.20
		3 mm	CS-R1	1SNK900103R0000	20	5.20
6 Test adapters	Dark grey	For test plugs DIA 2 mm 0.079 in	TP2	1SNK900203R0000	20	1.70
		For test plugs DIA 4 mm 0.157 in	TP4	1SNK900205R0000	20	2.40
7 Test connectors	Dark grey	TC5-R1	1SNK900201R0000	10	5.20	
8 Spacers	Dark grey	ES-TC6	1SNK900105R0000	10	0.80	
9 Shield connectors		SHBS	1SNK900600R0000	20	3.50	
10 Protecting covers	Transparent	PL6	1SNK900619R0000	10	1.80	
11 Terminal block markers	White	Blank marker	MG-CPM 13 41791	1SNK041791R0612	1680	0.27
		Blank card	MC612	1SNK150000R0000	22	10.00
		Universal wire markers holder	UMH	1SNK900611R0000	10	0.20

Complete list of accessories is indicated in the terminal block datasheet including end stops.

Some accessories such as jumper bars may modify the terminal block's ratings: Complete information available in the accessories section of the catalog.

Ground screw clamp terminal blocks

Description	Color	Type	Part Number	Pkg qty	Weight (1 pce) g
Ground	Green-yellow	ZS6-PE	1SNK506150R0000	20	13.70



Technical data valid for copper conductors only.

ZS6-3S screw clamp terminal blocks

Feed-through with 3 connections - 6 mm 0.236 in spacing



1SNK1610750014

ZS6-3S

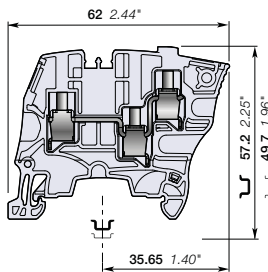

6 mm 0.236 in spacing

Description

- Recommended for energy markets and highly demanding applications requiring that only one conductor be connected per clamp,
- These blocks offer a high density connecting capacity (up to 3 connections) in a low profile and just 6 mm 0.236 in spacing.

Ordering details

Description	Color	Type	Part Number	Pkg qty	Weight (1 pce) g
Feed-through	Grey	ZS6-3S	1SNK506011R0000	50	11.80
	Blue	ZS6-3S-BL	1SNK506021R0000	50	11.80
	Yellow	ZS6-3S-YL	1SNK506067R0000	50	11.80

Main technical data

Connecting capacity		IEC	UL - CSA	Mounting instructions	
1 conductor per clamp	Rigid: Solid/Stranded	0.2 ... 6 mm ²	24 ... 10 AWG	Rail	TH 35-7.5, TH 35-15
	Flexible without ferrule	0.22 ... 6 mm ²		Wire stripping length	10.5 mm 0.413 in
	Flexible with non insulated ferrule	0.22 ... 4 mm ²	24 ... 12 AWG	Tool	Flat screwdriver Ø 4 mm Ø 0.157 in
	Flexible with insulated ferrule	0.22 ... 4 mm ²	24 ... 12 AWG		
2 conductors per clamp	Rigid: Solid/Stranded	0.2 ... 2.5 mm ²	24 ... 14 AWG	Torque	0.75 Nm ± 0.05 6.64 lb.in ± 0.443
	Flexible without ferrule	0.2 ... 2.5 mm ²	30 A / 10 AWG		
	Flexible with twin ferrule	0.22 ... 2.5 mm ²	24 ... 14 AWG		
Rated current / Rated cross section		32 A / 4 mm ²	30 A / 10 AWG		
Maximum current / Maximum cross section		39 A / 6 mm ²			
Rated short-time withstand current (1s)		480 A			
Short Circuit Current Rating (with specific conditions)			100 kA		
Rated voltage		800 V	600 V		
Impulse withstand voltage		8000 V			
Protection		IP20	NEMA 1		
Increased safety Ex e		550 V 29 A IEC/EN 60079-7 - IM2 II 2 GD Ex eb III/IIIC - 600 V 30 A			

The connecting capacity data for one Rigid: Solid/Stranded, or one Flexible conductor (when applicable) is a mandatory information required by IEC, UL and CSA standards (Copper conductors). All other data are provided as supplementary information only. For more details, please consult our CB, UL or CSA certificates and technical datasheet available on <http://www.TE.com>



Accessories

Description	Color	Type	Part Number	Pkg qty	Weight (1 pce) g	
1 End stops	Dark grey	BAM4	1SNK900001R0000	50	14.00	
2 End sections	Dark grey	ES6-3S	1SNK505912R0000	20	2.50	
3 Jumper bars	Orange	2 poles	JB6-2	1SNK906302R0000	50	1.30
		3 poles	JB6-3	1SNK906303R0000	50	2.10
		4 poles	JB6-4	1SNK906304R0000	50	2.90
		5 poles	JB6-5	1SNK906305R0000	50	3.60
		10 poles	JB6-10	1SNK906310R0000	20	7.40
50 poles	JB6-50	1SNK906350R0000	10	38.10		
4 Cross spacing jumpers	Orange	JB85-3	1SNK900603R0000	10	2.80	
5 Circuit separators	Dark grey	0 mm	CS	1SNK900101R0000	20	0.20
		3 mm	CS-R1	1SNK900103R0000	20	5.20
6 Test adapters	Dark grey	For test plugs DIA 2 mm 0.079 in	TP2	1SNK900203R0000	20	1.70
		For test plugs DIA 4 mm 0.157 in	TP4	1SNK900205R0000	20	2.40
7 Test connectors	Dark grey	TC5-R1	1SNK900201R0000	10	5.20	
8 Spacers	Dark grey	ES-TC6	ES-TC6	1SNK900105R0000	10	0.80
			Blank marker	MG-CPM 13 41791	1SNB041791R0612	1680
9 Terminal block markers	White	MC612	1SNK150000R0000	22	10.00	
		MC612PA	1SNK159999R0000	20	11.00	
		Universal wire markers holder	UMH	1SNK900611R0000	10	0.20

Complete list of accessories is indicated in the terminal block datasheet including end stops.

Some accessories such as jumper bars may modify the terminal block's ratings: Complete information available in the accessories section of the catalog.

Ground screw clamp terminal blocks

Description	Color	Type	Part Number	Pkg qty	Weight (1 pce) g
Ground	Green-yellow	ZS6-3S-PE	1SNK506151R0000	25	16.20

Technical data valid for copper conductors only.

ZS6-4S screw clamp terminal blocks

Feed-through with 4 connections - 6 mm 0.236 in spacing

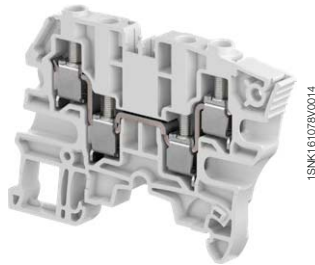

ZS6-4S

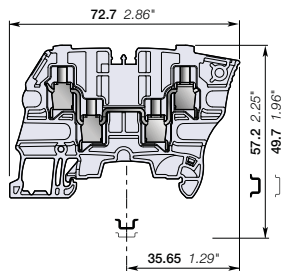

6 mm 0.236 in spacing

Description

- High density wiring (one potential distribution on 4 independent screw clamps) in a very low profile and just 6 mm 0.236 in spacing,
- Recommended for energy markets and highly demanding applications requiring that only one conductor be connected per clamp.

Ordering details

Description	Color	Type	Part Number	Pkg qty	Weight (1 pce) g
Feed-through	Grey	ZS6-4S	1SNK506012R0000	50	15.00
	Blue	ZS6-4S-BL	1SNK506022R0000	50	15.00
	Yellow	ZS6-4S-YL	1SNK506068R0000	50	15.00

Main technical data

Connecting capacity	IEC	UL - CSA	Mounting instructions
1 conductor per clamp	Rigid: Solid/Stranded	0.2 ... 6 mm ²	24 ... 10 AWG
	Flexible without ferrule	0.22 ... 6 mm ²	
	Flexible with non insulated ferrule	0.22 ... 4 mm ²	24 ... 12 AWG
	Flexible with insulated ferrule	0.22 ... 4 mm ²	24 ... 12 AWG
Gauge	A4-B3		
2 conductors per clamp	Rigid: Solid/Stranded	0.2 ... 2.5 mm ²	24 ... 14 AWG
	Flexible without ferrule	0.2 ... 2.5 mm ²	
	Flexible with twin ferrule	0.22 ... 2.5 mm ²	24 ... 14 AWG
Rated current / Rated cross section	32 A / 4 mm ²	30 A / 10 AWG	
Maximum current / Maximum cross section	39 A / 6 mm ²		
Rated short-time withstand current (1s)	480 A		
Short Circuit Current Rating (with specific conditions)		100 kA	
Rated voltage	800 V	600 V	
Impulse withstand voltage	8000 V		
Protection	IP20	NEMA 1	
Increased safety Ex e	550 V 29 A IEC/EN 60079-7 - IM2 II 2 GD Ex eb I/II/IIIc - 600 V 30 A		

The connecting capacity data for one Rigid: Solid/Stranded, or one Flexible conductor (when applicable) is a mandatory information required by IEC, UL and CSA standards (Copper conductors). All other data are provided as supplementary information only. For more details, please consult our CB, UL or CSA certificates and technical datasheet available on <http://www.TE.com>



Accessories

Description	Color	Type	Part Number	Pkg qty	Weight (1 pce) g	
1 End stops	Dark grey	BAM4	1SNK900001R0000	50	14.00	
2 End sections	Dark grey	ES6-4S	1SNK505911R0000	20	3.10	
3 Jumper bars	Orange	2 poles	JB6-2	1SNK906302R0000	50	1.30
		3 poles	JB6-3	1SNK906303R0000	50	2.10
		4 poles	JB6-4	1SNK906304R0000	50	2.90
		5 poles	JB6-5	1SNK906305R0000	50	3.60
		10 poles	JB6-10	1SNK906310R0000	20	7.40
		50 poles	JB6-50	1SNK906350R0000	10	38.10
4 Cross spacing jumpers	Orange	JB85-3	1SNK900603R0000	10	2.80	
5 Circuit separators	Dark grey	0 mm	CS	1SNK900101R0000	20	0.20
		3 mm	CS-R1	1SNK900103R0000	20	5.20
6 Test adapters	Dark grey	For test plugs DIA 2 mm 0.079 in	TP2	1SNK900203R0000	20	1.70
		For test plugs DIA 4 mm 0.157 in	TP4	1SNK900205R0000	20	2.40
7 Test connectors	Dark grey	TC5-R1	1SNK900201R0000	10	5.20	
8 Spacers	Dark grey	ES-TC6	1SNK900105R0000	10	0.80	
9 Terminal block markers	White	Blank marker	MG-CPM 13 41791	1SNB041791R0612	1680	0.27
		Blank card	MC612	1SNK150000R0000	22	10.00
			MC612PA	1SNK159999R0000	20	11.00
		Universal wire markers holder	Grey	UMH	1SNK900611R0000	10

Complete list of accessories is indicated in the terminal block datasheet including end stops.

Some accessories such as jumper bars may modify the terminal block's ratings: Complete information available in the accessories section of the catalog.

Ground screw clamp terminal blocks

Description	Color	Type	Part Number	Pkg qty	Weight (1 pce) g
Ground	Green-yellow	ZS6-4S-PE	1SNK506152R0000	25	19.40

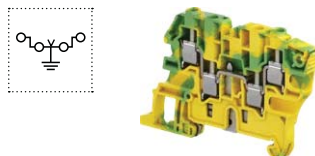

Technical data valid for copper conductors only.



ZS10 screw clamp terminal blocks

Feed-through - 8 mm 0.315 in spacing

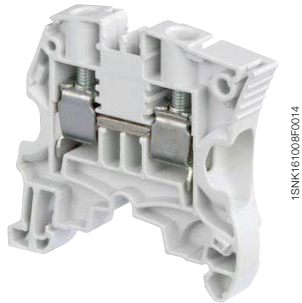

ZS10

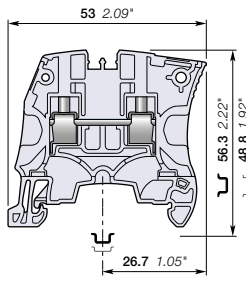

8 mm 0.315 in spacing

Description

- Save space by connecting conductors up to 10 mm² (without insulated ferrule, CB certified) 6 AWG in just 8 mm 0.315 in spacing,
- Perfectly adapted to solar applications: voltage is rated 1000 V AC / DC IEC.

Ordering details

Description	Color	Type	Part Number	Pkg qty	Weight (1 pce) g
Feed-through	Grey	ZS10	1SNK508010R0000	50	14.10
	Blue	ZS10-BL	1SNK508020R0000	50	14.10
	Orange	ZS10-OR	1SNK508030R0000	50	14.10
	Yellow	ZS10-YL	1SNK508060R0000	50	14.10
	Green	ZS10-GN	1SNK508061R0000	50	14.10
	Red	ZS10-RD	1SNK508062R0000	50	14.10
	Purple	ZS10-PR	1SNK508063R0000	50	14.10
	Brown	ZS10-BR	1SNK508064R0000	50	14.10
	White	ZS10-WH	1SNK508065R0000	50	14.10
	Black	ZS10-BK	1SNK508066R0000	50	14.10

Main technical data

Connecting capacity		IEC	UL - CSA	Mounting instructions	
1 conductor per clamp	Rigid: Solid/Stranded	0.5 ... 10 mm ²	24 ... 6 AWG	Rail	TH 35-7.5, TH 35-15
	Flexible without ferrule	0.5 ... 10 mm ²		Wire stripping length	12 mm 0.472 in
	Flexible with non insulated ferrule	0.5 ... 10 mm ²	24 ... 8 AWG	Tool	Flat screwdriver Ø 4 mm Ø 0.157 in
	Flexible with insulated ferrule	0.5 ... 6 mm ²	24 ... 10 AWG		
	Gauge	A5-B5		Torque	1.3 Nm ± 0.3 11.5 lb.in ± 2.65
2 conductors per clamp	Rigid: Solid/Stranded	0.5 ... 4 mm ²	20 ... 12 AWG		
	Flexible without ferrule	0.5 ... 4 mm ²			
	Flexible with twin ferrule	0.5 ... 4 mm ²	20 ... 12 AWG		
Rated current / Rated cross section		57 A / 10 mm ²	42 A / 6 AWG		
Rated short-time withstand current (1s)		1200 A			
Short Circuit Current Rating (with specific conditions)			100 kA		
Rated voltage		1000 V	600 V		
Impulse withstand voltage		8000 V			
Protection		IP20	NEMA 1		

Increased safety Ex e 693 V 57 A IEC/EN 60079-7 - IM2 II 2 GD Ex eb III/IIIC - 600 V 42 A UL 60079-7 - Class I, Zone 1, AEx e II, Ex e II U

The connecting capacity data for one Rigid: Solid/Stranded, or one Flexible conductor (when applicable) is a mandatory information required by IEC, UL and CSA standards (Copper conductors). All other data are provided as supplementary information only. For more details, please consult our CB, UL or CSA certificates and technical datasheet available on <http://www.TE.com>



Accessories

Description	Color	Type	Part Number	Pkg qty	Weight (1 pce) g	
1 End stops	Dark grey	BAM4	1SNK900001R0000	50	14.00	
2 End sections	Dark grey	ES4	1SNK505910R0000	20	2.20	
3 Jumper bars	Orange	2 poles	JB8-2	1SNK908302R0000	50	2.70
		3 poles	JB8-3	1SNK908303R0000	50	4.10
		4 poles	JB8-4	1SNK908304R0000	50	5.60
		5 poles	JB8-5	1SNK908305R0000	40	7.00
		10 poles	JB8-10	1SNK908310R0000	20	14.20
4 Cross spacing jumpers	Orange	JB85-3	1SNK900603R0000	10	2.80	
5 Circuit separators	Dark grey	0 mm	CS	1SNK900101R0000	20	0.20
		3 mm	CS-R1	1SNK900103R0000	20	5.20
6 Test adapters	Dark grey	For test plugs DIA 2 mm 0.079 in	TP2	1SNK900203R0000	20	1.70
		For test plugs DIA 4 mm 0.157 in	TP4	1SNK900205R0000	20	2.40
7 Test connectors	Dark grey	5.2 mm 0.205 in spacing	TC5	1SNK900200R0000	10	5.20
		End module, 5.2 mm 0.205 in	TC5-R1	1SNK900201R0000	10	5.20
8 Spacers	Dark grey	ES-TC8	1SNK900104R0000	10	1.40	
9 Protecting covers	Transparent	PL8	1SNK900620R0000	10	2.60	
10 Terminal block markers	White	Blank marker	MG-CPM 13 41791	1SNB041791R0612	1680	0.27
		Blank card	MC812	1SNK160000R0000	22	10.00
			MC812PA	1SNK169999R0000	20	14.00
		Universal wire markers holder	Grey	UMH	1SNK900611R0000	10

Complete list of accessories is indicated in the terminal block datasheet including end stops.

Some accessories such as jumper bars may modify the terminal block's ratings: Complete information available in the accessories section of the catalog.

Ground screw clamp terminal blocks

Description	Color	Type	Part Number	Pkg qty	Weight (1 pce) g
Ground	Green-yellow	ZS10-PE	1SNK508150R0000	20	22.50

Technical data valid for copper conductors only.

ZS16 screw clamp terminal blocks

Feed-through - 10 mm 0.394 in spacing

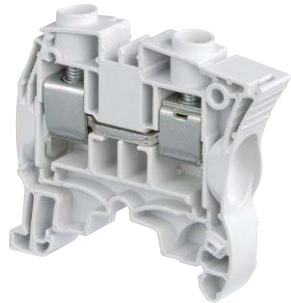

ZS16

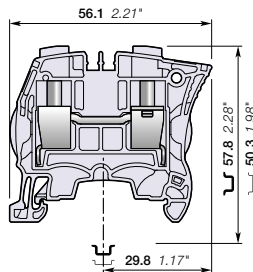

10 mm 0.394 in spacing

Description

- Save space by connecting conductors up to 16 mm² (without insulated ferrule, CB certified) 4 AWG in just 10 mm 0.394 in spacing,
- Perfectly adapted to solar applications: voltage is rated 1000 V AC / DC IEC.

Ordering details

Description	Color	Type	Part Number	Pkg qty	Weight (1 pce) g
Feed-through	Grey <input type="checkbox"/>	ZS16	1SNK510010R0000	25	20.20
	Blue <input type="checkbox"/>	ZS16-BL	1SNK510020R0000	25	20.20
	Orange <input type="checkbox"/>	ZS16-OR	1SNK510030R0000	25	20.20

Main technical data

Connecting capacity		IEC	UL - CSA	Mounting instructions	
1 conductor per clamp	Rigid: Solid/Stranded	0.5 ... 16 mm ²	24 ... 4 AWG	Rail	TH 35-7.5, TH 35-15
	Flexible without ferrule	0.5 ... 16 mm ²		Wire stripping length	13.5 mm 0.531 in
	Flexible with non insulated ferrule	0.5 ... 16 mm ²	24 ... 4 AWG		
	Flexible with insulated ferrule	0.5 ... 10 mm ²	24 ... 8 AWG		
	Gauge	A6-B6			
2 conductors per clamp	Rigid: Solid/Stranded	0.5 ... 6 mm ²	20 ... 10 AWG	Tool	Flat screwdriver Ø 5.5 mm Ø 0.217 in
	Flexible without ferrule	0.5 ... 6 mm ²	20 ... 10 AWG		
	Flexible with twin ferrule	0.5 ... 6 mm ²	20 ... 10 AWG		
Rated current / Rated cross section		76 A / 16 mm ²	67 A / 4 AWG	Torque	1.8 Nm ± 0.2 15.9 lb.in ± 1.77
Rated short-time withstand current (1s)		1920 A			
Short Circuit Current Rating (with specific conditions)			100 kA		
Rated voltage		1000 V	600 V		
Impulse withstand voltage		8000 V			
Protection		IP20	NEMA 1		
Increased safety Ex e		693 V 76 A IEC/EN 60079-7 - IM2 II 2 GD Ex eb I/IIIC - 600 V 67 A UL 60079-7 - Class I, Zone 1, AEx e II, Ex e II U			

The connecting capacity data for one Rigid: Solid/Stranded, or one Flexible conductor (when applicable) is a mandatory information required by IEC, UL and CSA standards (Copper conductors). All other data are provided as supplementary information only. For more details, please consult our CB, UL or CSA certificates and technical datasheet available on <http://www.TE.com>

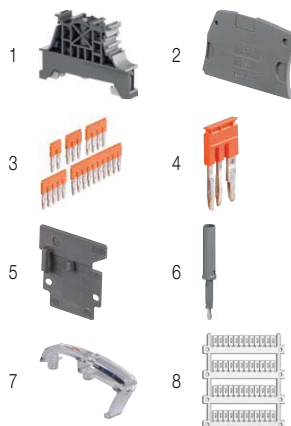

Accessories

Description	Color	Type	Part Number	Pkg qty	Weight (1 pce) g	
1 End stops	Dark grey <input type="checkbox"/>	BAM4	1SNK900001R0000	50	14.00	
2 End sections	Dark grey <input type="checkbox"/>	ES4	1SNK505910R0000	20	2.20	
3 Jumper bars	Orange <input type="checkbox"/>	2 poles	JB10-2	1SNK910302R0000	50	4.60
		3 poles	JB10-3	1SNK910303R0000	50	7.10
		4 poles	JB10-4	1SNK910304R0000	40	9.40
		5 poles	JB10-5	1SNK910305R0000	30	12.00
		10 poles	JB10-10	1SNK910310R0000	20	24.00
4 Cross spacing jumpers	Orange <input type="checkbox"/>	JB85-3	1SNK900603R0000	10	2.80	
5 Circuit separators	Dark grey <input type="checkbox"/>	0 mm	CS	1SNK900101R0000	20	0.20
		3 mm	CS-R1	1SNK900103R0000	20	5.20
6 Test adapters	Dark grey <input type="checkbox"/>	For test plugs DIA 2 mm 0.079 in	TP2	1SNK900203R0000	20	1.70
		For test plugs DIA 4 mm 0.157 in	TP4	1SNK900205R0000	20	2.40
7 Protecting covers	Transparent <input type="checkbox"/>	PL10	1SNK900621R0000	10	3.10	
	White <input type="checkbox"/>	MG-CPM 13 41791	1SNB041791R0612	1680	0.27	
8 Terminal block markers	White <input type="checkbox"/>	MC812	1SNK160000R0000	22	10.00	
		MC812PA	1SNK169999R0000	20	14.00	
		Universal wire markers holder	Grey <input type="checkbox"/>	UMH	1SNK900611R0000	10

Complete list of accessories is indicated in the terminal block datasheet including end stops. Some accessories such as jumper bars may modify the terminal block's ratings: Complete information available in the accessories section of the catalog.

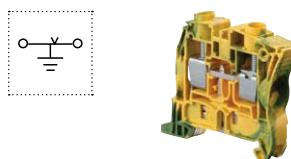

Ground screw clamp terminal blocks

Description	Color	Type	Part Number	Pkg qty	Weight (1 pce) g
Ground	Green-yellow <input type="checkbox"/>	ZS16-PE	1SNK510150R0000	20	32.00

Technical data valid for copper conductors only.

ZS25 screw clamp terminal blocks

Feed-through - 12 mm 0.472 in spacing

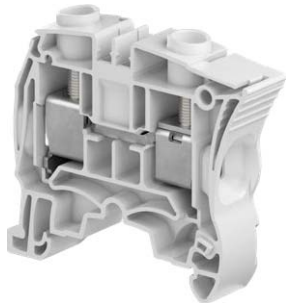

ZS25

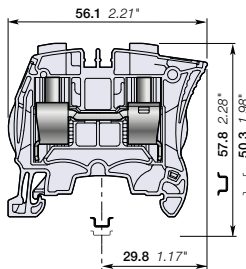

12 mm 0.472 in spacing

Description

- Save space by connecting conductors up to 25 mm² (without insulated ferrule, CB certified) 3 AWG in just 12 mm 0.472 in spacing,
- Perfectly adapted to solar applications: voltage is rated 1000 V AC / DC IEC.

Ordering details

Description	Color	Type	Part Number	Pkg qty	Weight (1 pce) g
Feed-through	Grey <input type="checkbox"/>	ZS25	1SNK512010R0000	25	21.40
	Blue <input type="checkbox"/>	ZS25-BL	1SNK512020R0000	25	21.40
	Yellow <input type="checkbox"/>	ZS25-YL	1SNK512060R0000	25	21.40

Main technical data

Connecting capacity		IEC	UL - CSA	Mounting instructions	
1 conductor per clamp	Rigid: Solid/Stranded	0.5 ... 25 mm ²	24 ... 3 AWG	Rail	TH 35-7.5, TH 35-15
	Flexible without ferrule	0.5 ... 25 mm ²		Wire stripping length	13.5 mm 0.531 in
	Flexible with non insulated ferrule	0.5 ... 16 mm ²	24 ... 4 AWG		
	Flexible with insulated ferrule	0.5 ... 16 mm ²	24 ... 8 AWG		
	Gauge	A6-B6			
2 conductors per clamp	Rigid: Solid/Stranded	0.5 ... 10 mm ²	20 ... 10 AWG	Tool	Flat screwdriver Ø 5.5 mm Ø 0.217 in
	Flexible without ferrule	0.5 ... 10 mm ²	20 ... 10 AWG		
	Flexible with twin ferrule	0.5 ... 10 mm ²	20 ... 10 AWG		
Rated current / Rated cross section		76 A / 16 mm ²	100 A / 3 AWG	Torque	1.8 Nm ± 0.2 15.9 lb.in ± 1.77
Maximum current / Maximum cross section		101 A / 25 mm ²			
Rated short-time withstand current (1s)		1920 A			
Short Circuit Current Rating (with specific conditions)			100 kA		
Rated voltage		1000 V	600 V		
Impulse withstand voltage		8000 V			
Protection		IP20	NEMA 1		
Increased safety Ex e		693 V 69 A IEC/EN 60079-7 - IM2 II 2 GD Ex eb I/II/III-C - 600 V 100 A			

The connecting capacity data for one Rigid: Solid/Stranded, or one Flexible conductor (when applicable) is a mandatory information required by IEC, UL and CSA standards (Copper conductors). All other data are provided as supplementary information only. For more details, please consult our CB, UL or CSA certificates and technical datasheet available on <http://www.TE.com>



Accessories

Description	Color	Type	Part Number	Pkg qty	Weight (1 pce) g	
1 End stops 10 mm 0.394 in	Dark grey <input type="checkbox"/>	BAM4	1SNK900001R0000	50	14.00	
2 End sections 2.2 mm 0.087 in	Dark grey <input type="checkbox"/>	ES4	1SNK505910R0000	20	2.20	
3 Jumper bars	Orange <input type="checkbox"/>	2 poles 76 A (IEC)	JB12-2	1SNK912302R0000	50	4.90
		3 poles 76 A (IEC)	JB12-3	1SNK912303R0000	50	7.60
		5 poles 76 A (IEC)	JB12-5	1SNK912305R0000	20	12.90
4 Cross spacing jumpers 3 poles 32 A (IEC)	Orange <input type="checkbox"/>	JB85-3	1SNK900603R0000	10	2.80	
5 Circuit separators	Dark grey <input type="checkbox"/>	0 mm 0 in	CS	1SNK900101R0000	20	0.20
		3 mm 0.118 in	CS-R1	1SNK900103R0000	20	5.20
6 Test adapters	Dark grey <input type="checkbox"/>	For test plugs DIA 2 mm 0.079 in	TP2	1SNK900203R0000	20	1.70
		For test plugs DIA 4 mm 0.157 in	TP4	1SNK900205R0000	20	2.40
7 Protecting covers 10 mm 0.394 in spacing	Transparent <input type="checkbox"/>	PL10	1SNK900621R0000	10	3.10	
8 Terminal block markers	White <input type="checkbox"/>	Blank marker	MG-CPM 13 41791	1SNB041791R0612	1680	0.27
		Blank card	MC812	1SNK160000R0000	22	10.00
			MC812PA	1SNK169999R0000	20	14.00
		Universal wire markers holder	Grey <input type="checkbox"/>	UMH	1SNK900611R0000	10

Complete list of accessories is indicated in the terminal block datasheet including end stops. Some accessories such as jumper bars may modify the terminal block's ratings: Complete information available in the accessories section of the catalog.

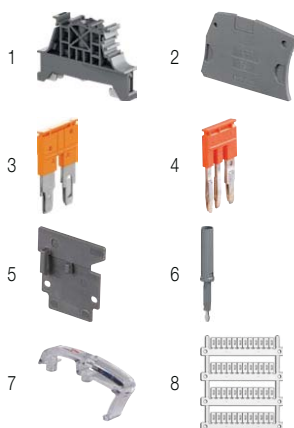

Ground screw clamp terminal blocks

Description	Color	Type	Part Number	Pkg qty	Weight (1 pce) g
Ground Profile aligned with ZS25	Green-yellow <input type="checkbox"/>	ZS25-PE	1SNK512150R0000	20	38.00

Technical data valid for copper conductors only.

ZS35 screw clamp terminal blocks

Feed-through - 16 mm 0.630 in spacing



ZS35

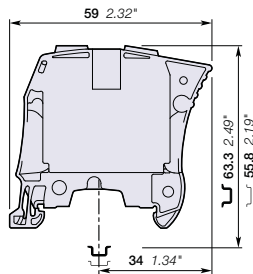

16 mm 0.630 in spacing

Description

Closed terminal block:

- No end section needed,
- Optimized rigidity,
- Perfectly adapted to solar applications: voltage is rated 1000 V AC / DC IEC.

Ordering details

Description	Color	Type	Part Number	Pkg qty	Weight (1 pce)
Feed-through Closed block	Grey <input type="checkbox"/>	ZS35	1SNK516010R0000	20	53.40
	Blue <input type="checkbox"/>	ZS35-BL	1SNK516020R0000	20	53.40
	Orange <input type="checkbox"/>	ZS35-OR	1SNK516030R0000	20	53.40

Main technical data

Connecting capacity		IEC	UL - CSA	Mounting instructions	
1 conductor per clamp	Rigid: Solid/Stranded	6 ... 35 mm ²	10 ... 0 AWG	Rail	TH 35-7.5, TH 35-15
	Flexible without ferrule	6 ... 35 mm ²		Wire stripping length	17 mm 0.669 in
	Flexible with non insulated ferrule	4 ... 35 mm ²	10 ... 2 AWG		
	Flexible with insulated ferrule	4 ... 35 mm ²	10 ... 2 AWG		
	Gauge	A9-B9			
2 conductors per clamp	Rigid: Solid/Stranded	6 ... 16 mm ²	10 ... 6 AWG	Tool	Flat screwdriver Ø 6.5 mm Ø 0.256 in
	Flexible without ferrule	6 ... 16 mm ²			
	Flexible with twin ferrule	4 ... 10 mm ²	12 ... 8 AWG		
Rated current / Rated cross section		125 A / 35 mm ²	150 A / 0 AWG	Torque	2.9 Nm ± 0.1 25.7 lb.in ± 0.885
Rated short-time withstand current (1s)		4200 A			
Short Circuit Current Rating (with specific conditions)			100 kA		
Rated voltage		1000 V	600 V		
Impulse withstand voltage		8000 V			
Protection		IP10	NEMA 1		
Increased safety Ex e		693 V 125 A IEC/EN 60079-7 - IM2 II 2 GD Ex eb I/IIIC - 600 V 150 A UL 60079-7 - Class I, Zone 1, AEx e II			

The connecting capacity data for one Rigid: Solid/Stranded, or one Flexible conductor (when applicable) is a mandatory information required by IEC, UL and CSA standards (Copper conductors). All other data are provided as supplementary information only. For more details, please consult our CB, UL or CSA certificates and technical datasheet available on <http://www.TE.com>



Accessories

Description	Color	Type	Part Number	Pkg qty	Weight (1 pce)
1 End stops	Dark grey <input type="checkbox"/>	BAZH1	1SNK900102R0000	20	24.00
2 Jumper bars	Orange <input type="checkbox"/>	JB16-2	1SNK916302R0000	10	10.00
		JB16-3	1SNK916303R0000	10	16.00
		JB16-4	1SNK916304R0000	10	22.00
		JB16-5	1SNK916305R0000	10	28.00
		JB16-10	1SNK916310R0000	10	56.60
3 Circuit separators	Dark grey <input type="checkbox"/>	CS-R1	1SNK900103R0000	20	5.20
4 Protecting covers	Transparent <input type="checkbox"/>	PL16	1SNK900622R0000	10	4.60
5 Terminal block markers	White <input type="checkbox"/>	MG-CPM 13 41791	1SNB041791R0612	1680	0.27
		MC812	1SNK160000R0000	22	10.00
		MC812PA	1SNK169999R0000	20	14.00
	Grey <input type="checkbox"/>	UMH	1SNK900611R0000	10	0.20

Complete list of accessories is indicated in the terminal block datasheet including end stops.

Some accessories such as jumper bars may modify the terminal block's ratings: Complete information available in the accessories section of the catalog.

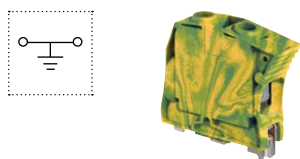

Ground screw clamp terminal blocks

Description	Color	Type	Part Number	Pkg qty	Weight (1 pce)
Ground	Green-yellow <input type="checkbox"/>	ZS35-PE	1SNK516150R0000	20	81.80

Technical data valid for copper conductors only.

ZS50 screw clamp terminal blocks

Feed-through - 16 mm 0.630 in spacing

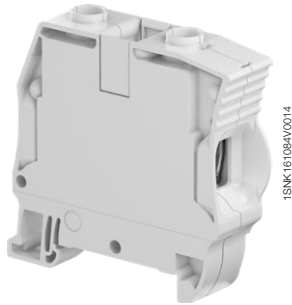

1SNK161084V0014

ZS50

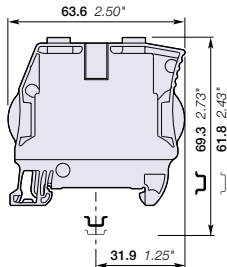

16 mm 0.630 in spacing

Description

Combine high performance with compact dimensions:

- Connect conductors up to 50 mm² (CB certified) 0 AWG in just 16 mm 0.630 in spacing,
- Perfectly adapted to solar applications: 1250 V DC (1000 V AC) IEC and 1000 V UL,
- Closed terminal block: no end section needed, optimized rigidity.

Ordering details

Description	Color	Type	Part Number	Pkg qty	Weight (1 pce) g
Feed-through Closed block	Grey	ZS50	1SNK516011R0000	20	52.90
	Blue	ZS50-BL	1SNK516021R0000	20	52.90
	Yellow	ZS50-YL	1SNK516060R0000	20	52.90
	Red	ZS50-RD	1SNK516063R0000	20	52.90
	Black	ZS50-BK	1SNK516064R0000	20	52.90

Main technical data

Connecting capacity		IEC	UL - CSA	Rail		TH 35-7.5, TH 35-15
1 conductor per clamp	Rigid: Solid/Stranded	1 ... 50 mm ²	18 ... 0 AWG	Wire stripping length		17 mm 0.669 in
	Flexible without ferrule	1 ... 50 mm ²	18 ... 0 AWG			
	Flexible with non insulated ferrule	1 ... 50 mm ²	18 ... 0 AWG			
	Flexible with insulated ferrule	1 ... 50 mm ²	18 ... 0 AWG			
	Gauge	Dia. 11				
2 conductors per clamp	Rigid: Solid/Stranded	1 ... 25 mm ²	18 ... 4 AWG	Tool		Flat screwdriver Ø 6.5 mm Ø 0.256 in
	Flexible without ferrule	1 ... 25 mm ²	18 ... 4 AWG			
	Flexible with twin ferrule	1 ... 16 mm ²	18 ... 4 AWG			
Rated current / Rated cross section		150 A / 50 mm ²	140 A / 0 AWG	Torque		3 Nm ± 0.50 26.6 lb.in ± 4.43
Rated short-time withstand current (1s)		6000 A				
Short Circuit Current Rating (with specific conditions)			100 kA			
Rated voltage		1000 V	1000 V			
Impulse withstand voltage		8000 V				
Protection		IP10	NEMA 1			
Increased safety Ex e		880 V 150 A IEC/EN 60079-7 - IM2 II 2 GD Ex eb I/IIIC				

The connecting capacity data for one Rigid: Solid/Stranded, or one Flexible conductor (when applicable) is a mandatory information required by IEC, UL and CSA standards (Copper conductors). All other data are provided as supplementary information only. For more details, please consult our CB, UL or CSA certificates and technical datasheet available on <http://www.TE.com>



Accessories

Description	Color	Type	Part Number	Pkg qty	Weight (1 pce) g	
1 End stops	Dark grey	BAZH1	1SNK900102R0000	20	24.00	
2 Jumper bars	Orange	2 poles 125 A (IEC)	JB16-2	1SNK916302R0000	10	10.00
		3 poles 125 A (IEC)	JB16-3	1SNK916303R0000	10	16.00
		4 poles 125 A (IEC)	JB16-4	1SNK916304R0000	10	22.00
		5 poles 125 A (IEC)	JB16-5	1SNK916305R0000	10	28.00
		10 poles 125 A (IEC)	JB16-10	1SNK916310R0000	10	56.60
3 Terminal block markers	White	Blank marker	MG-CPM 13 41791	1SNB041791R0612	1680	0.27
		Blank card	MC812	1SNK160000R0000	22	10.00
			MC812PA	1SNK169999R0000	20	14.00
	Universal wire markers holder	Grey	UMH	1SNK900611R0000	10	0.20

Complete list of accessories is indicated in the terminal block datasheet including end stops. Some accessories such as jumper bars may modify the terminal block's ratings: Complete information available in the accessories section of the catalog.

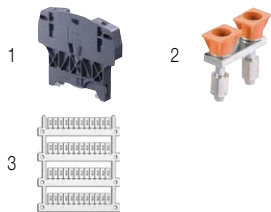

Ground screw clamp terminal blocks

Description	Color	Type	Part Number	Pkg qty	Weight (1 pce) g
Ground Profile aligned with ZS50	Green-yellow	ZS50-PE	1SNK516151R0000	20	83.00

Technical data valid for copper conductors only.

ZS70 screw clamp terminal blocks

Feed-through - 22 mm 0.866 in spacing



ZS70

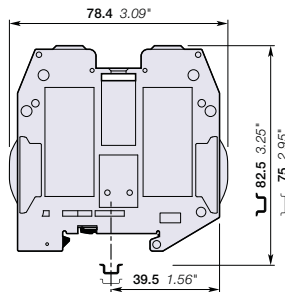

22 mm 0.866 in spacing

Description

Closed terminal block:

- No end section needed,
- Optimized rigidity,
- Perfectly adapted to solar applications: 1250 V DC (1000 V AC) IEC and 1000 V UL.

Ordering details

Description	Color	Type	Part Number	Pkg qty	Weight (1 pce) g
Feed-through Closed block	Grey	ZS70	1SNK522010R0000	10	158.10
	Blue	ZS70-BL	1SNK522020R0000	10	158.10
	Yellow	ZS70-YL	1SNK522060R0000	10	158.10

Main technical data

Connecting capacity		IEC	UL - CSA	Mounting instructions	
1 conductor per clamp	Rigid: Solid/Stranded	16 ... 95 mm ²	4 ... 00 AWG	Rail	TH 35-7.5, TH 35-15
	Flexible without ferrule	16 ... 70 mm ²		Wire stripping length	25 mm 0.984 in
	Flexible with non insulated ferrule	16 ... 50 mm ²			
	Flexible with insulated ferrule	16 ... 50 mm ²			
Gauge		B11		Tool	Allen key Ø 6 mm Ø 0.236 in
2 conductors per clamp	Rigid: Solid/Stranded	16 ... 35 mm ²	4 ... 2 AWG		
	Flexible without ferrule	16 ... 35 mm ²			
	Flexible with twin ferrule	16 mm ²	6 AWG		
Rated current / Rated cross section		192 A / 70 mm ²	159 A / 00 AWG	Torque	6.5 Nm ± 0.5 57.5 lb.in ± 4.43
Rated short-time withstand current (1s)		8400 A			
Short Circuit Current Rating (with specific conditions)			100 kA		
Rated voltage		1000 V	1000 V		
Impulse withstand voltage		8000 V			
Protection		IP10	NEMA 1		

Increased safety Ex e 693 V 192 A IEC/EN 60079-7 - IM2 II 2 GD Ex eb I/II/III - 600 V 159 A UL 60079-7 - Class I, Zone 1, AEx e II, Ex e II U

The connecting capacity data for one Rigid: Solid/Stranded, or one Flexible conductor (when applicable) is a mandatory information required by IEC, UL and CSA standards (Copper conductors). All other data are provided as supplementary information only. For more details, please consult our CB, UL or CSA certificates and technical datasheet available on <http://www.TE.com>

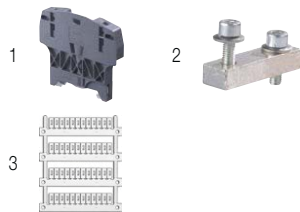

Accessories

Description	Color	Type	Part Number	Pkg qty	Weight (1 pce) g		
1 End stops	Dark grey	BAZH1	1SNK900102R0000	20	24.00		
2 Jumper bars		10 mm 0.394 in	JB22-2	1SNK922302R0000	5	27.00	
		2 poles 192 A (IEC)	JB22-3	1SNK922303R0000	5	43.30	
		3 poles 192 A (IEC)	JB22-5	1SNK922305R0000	5	76.10	
		5 poles 192 A (IEC)	JB22-10	1SNK922310R0000	5	157.40	
		10 poles 192 A (IEC)	MG-CPM 13 41791	1SNB041791R0612	1680	0.27	
3 Terminal block markers	White	Blank marker	MC812	1SNK160000R0000	22	10.00	
		Blank card	MC812PA	1SNK169999R0000	20	14.00	
			Universal wire markers holder	UMH	1SNK900611R0000	10	0.20

Complete list of accessories is indicated in the terminal block datasheet including end stops.

Some accessories such as jumper bars may modify the terminal block's ratings: Complete information available in the accessories section of the catalog.

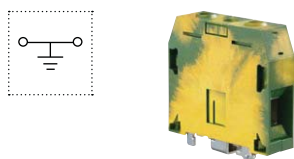

Ground screw clamp terminal blocks

Description	Color	Type	Part Number	Pkg qty	Weight (1 pce) g
Ground	Green-yellow	ZS70-PE	1SNK522150R0000	10	222.00

Technical data valid for copper conductors only.

ZS95 screw clamp terminal blocks

Feed-through - 26 mm 1.024 in spacing



ZS95

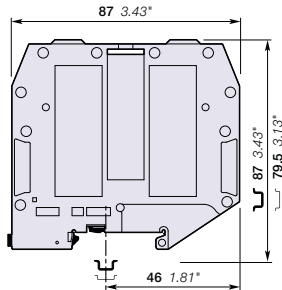

26 mm 1.024 in spacing

Description

Closed terminal block:

- No end section needed,
- Optimized rigidity,
- Perfectly adapted to solar applications: 1250 V DC (1000 V AC) IEC and 1000 V UL.

Ordering details

Description	Color	Type	Part Number	Pkg qty	Weight (1 pce)
Feed-through Closed block	Grey <input type="checkbox"/>	ZS95	1SNK526010R0000	10	215.10
	Blue <input type="checkbox"/>	ZS95-BL	1SNK526020R0000	10	215.10
	Yellow <input type="checkbox"/>	ZS95-YL	1SNK526060R0000	10	215.10

Main technical data

Connecting capacity		IEC	UL - CSA	Mounting instructions	
1 conductor per clamp	Rigid: Solid/Stranded	35 ... 120 mm ²	2 ... 0000 AWG	Rail	TH 35-7.5, TH 35-15
	Flexible without ferrule	35 ... 95 mm ²		Wire stripping length	26 mm 1.024 in
	Flexible with non insulated ferrule	35 ... 50 mm ²			
	Flexible with insulated ferrule	35 ... 50 mm ²			
	Gauge	B12			
2 conductors per clamp	Rigid: Solid/Stranded	25 ... 35 mm ²	4 ... 2 AWG	Tool	Allen key Ø 6 mm Ø 0.236 in
	Flexible without ferrule	25 ... 35 mm ²			
	Flexible with twin ferrule	16 mm ²	6 AWG		
Rated current / Rated cross section		232 A / 95 mm ²	230 A / 0000 AWG	Torque	9.25 Nm ± 0.25 81.7 lb.in ± 2.21
Rated short-time withstand current (1s)		11400 A			
Short Circuit Current Rating (with specific conditions)			100 kA		
Rated voltage		1000 V	1000 V		
Impulse withstand voltage		8000 V			
Protection		IP10	NEMA 1		
Increased safety Ex e		693 V 232 A IEC/EN 60079-7 - IM2 II 2 GD Ex eb I/II/III C - 600 V 230 A UL 60079-7 - Class I, Zone 1, AEx e II			

The connecting capacity data for one Rigid: Solid/Stranded, or one Flexible conductor (when applicable) is a mandatory information required by IEC, UL and CSA standards (Copper conductors). All other data are provided as supplementary information only. For more details, please consult our CB, UL or CSA certificates and technical datasheet available on <http://www.TE.com>



Accessories

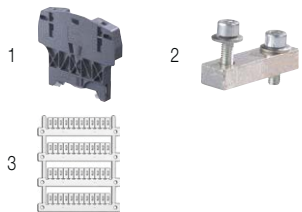

Description	Color	Type	Part Number	Pkg qty	Weight (1 pce)	
1 End stops	Dark grey <input type="checkbox"/>	BAZH1	1SNK900102R0000	20	24.00	
2 Jumper bars	2 poles	232 A (IEC)	JB26-2	1SNK926302R0000	5	41.20
	3 poles	232 A (IEC)	JB26-3	1SNK926303R0000	5	65.70
	5 poles	232 A (IEC)	JB26-5	1SNK926305R0000	5	115.70
	10 poles	232 A (IEC)	JB26-10	1SNK926310R0000	5	241.50
	3 Terminal block markers	Blank marker		MG-CPM 13 41791	1SNB041791R0612	1680
Blank card			MC812	1SNK160000R0000	22	10.00
			MC812PA	1SNK169999R0000	20	14.00
			Universal wire markers holder	Grey <input type="checkbox"/>	UMH	1SNK900611R0000

Complete list of accessories is indicated in the terminal block datasheet including end stops.

Some accessories such as jumper bars may modify the terminal block's ratings: Complete information available in the accessories section of the catalog.

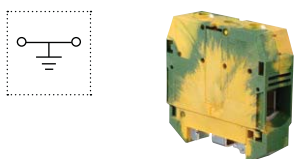

Ground screw clamp terminal blocks

Description	Color	Type	Part Number	Pkg qty	Weight (1 pce)
Ground	Green-yellow <input type="checkbox"/>	ZS95-PE	1SNK526150R0000	10	278.00

Technical data valid for copper conductors only.

ZS150 screw clamp terminal blocks

Feed-through - 31 mm 1.220 in spacing

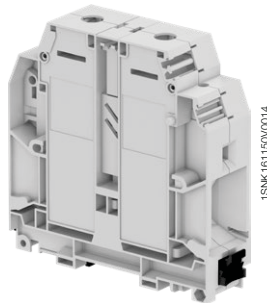

ZS150

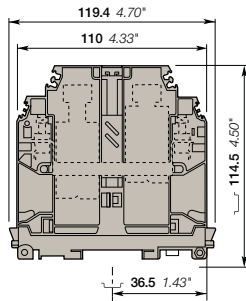

31 mm 1.220 in spacing

Description

- Perfectly adapted to solar applications : 1500V DC (1000V AC) IEC and 1000V UL,
- Closed terminal block: no end section needed, optimized rigidity,
- Ease your voltage monitoring or distribution with the 2 built-in derivations,
- Use of jumper bars requires the user to cut-out the partition.

Ordering details

Description	Color	Type	Part Number	Pkg qty	Weight (1 pce) g
Feed-through Closed block with 2 x 10 mm ² derivations.	Grey <input type="checkbox"/>	ZS150	1SNK531010R0000	5	318.00
	Blue <input type="checkbox"/>	ZS150-BL	1SNK531020R0000	5	318.00
	Yellow <input type="checkbox"/>	ZS150-YL	1SNK531060R0000	5	318.00

Main technical data

Connecting capacity		IEC	UL	CSA	Mounting instructions	
Main circuit with 1 conductor per clamp	Rigid: Solid/Stranded	35 ... 185 mm ²	2 ... 350 Kcmil	2 ... 350 Kcmil	Main circuit	TH 35-7.5, TH 35-15
	Flexible without ferrule	50 ... 150 mm ²			Wire stripping length	40 mm 1.575 in
Derivation with 1 conductor per clamp	Rigid: Solid/Stranded	0.5 ... 16 mm ²	20 ... 8 AWG	20 ... 8 AWG	Tool	Allen key Ø 8 mm Ø 0.315 in
	Flexible without ferrule	0.5 ... 10 mm ²	20 ... 8 Kcmil	20 ... 8 Kcmil	Torque	20 Nm 177 lb.in
Rated current / Rated cross section	Main circuit	Copper Aluminium	309 A / 150 mm ²	310 A / 350 Kcmil	310 A / 350 Kcmil	Derivation
	Derivation		57 A / 10 mm ²	50 A / 8 AWG	50 A / 8 AWG	Wire stripping length
Rated short-time withstand current (1s)		18000 A			Tool	Flat screwdriver Ø 4 mm Ø 0.157 in
Rated voltage	V AC	1000 V	1000 V	1000 V	Torque	1.2 Nm ... 1.4 Nm 10.6 lb.in ... 12.3 lb.in
	V DC	1500				
Impulse withstand voltage		12000 V				
Protection		IP10	NEMA 1			
Increased safety Ex e		1000 V 309 A IEC/EN 60079-7 - IM2 II 2 GD Ex eb I/II/III C				

The connecting capacity data for one Rigid: Solid/Stranded, or one Flexible conductor (when applicable) is a mandatory information required by IEC, UL and CSA standards (Copper conductors). All other data are provided as supplementary information only. For more details, please consult our CB, UL or CSA certificates and technical datasheet available on <http://www.TE.com>



Accessories

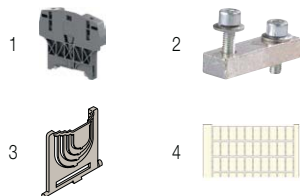

Description	Color	Type	Part Number	Pkg qty	Weight (1 pce) g
1 End stops	Dark grey <input type="checkbox"/>	BAZH1	1SNK900102R0000	20	24.00
2 Jumper bars		BJMI31.2	1SNA206053R0700	1	120.00
		BJMI31.3	1SNA206054R0000	1	190.00
3 Protecting covers		CPBP1	1SNA399788R1600	20	0.40
4 Terminal block markers		RC1010	1SNA238000R1600	10	1.30
		MG-CPM 13 41791	1SNB041791R0612	1680	0.27
		MC812	1SNK160000R0000	22	10.00
		MC812PA	1SNK169999R0000	20	14.00
		Universal wire markers holder	UMH	1SNK900611R0000	10

Complete list of accessories is indicated in the terminal block datasheet including end stops.

Some accessories such as jumper bars may modify the terminal block's ratings: Complete information available in the accessories section of the catalog.

Technical data valid for copper conductors only.

ZS240 screw clamp terminal blocks

Feed-through - 36 mm 1.417 in spacing

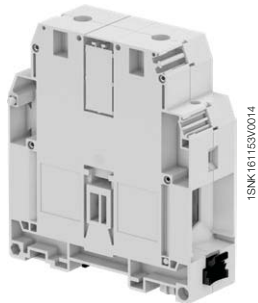

ZS240

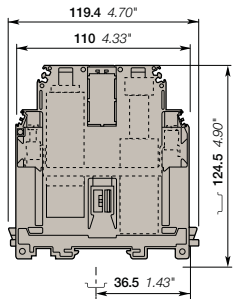

36 mm 1.417 in spacing

Description

- Perfectly adapted to solar applications : 1500V DC (1000V AC) IEC and 1000V UL,
- UL Certified for aluminum cables use - Closed terminal block: no end section needed, optimized rigidity,
- Ease your voltage monitoring or distribution with the 2 built-in derivations,
- Use of jumper bars requires the user to cut-out the partition.

Ordering details

Description	Color	Type	Part Number	Pkg qty	Weight (1 pce)
Feed-through Closed block with 2 x 10 mm ² derivations.	Grey <input type="checkbox"/>	ZS240	1SNK536010R0000	5	366.00
	Blue <input type="checkbox"/>	ZS240-BL	1SNK536020R0000	5	366.00
	Yellow <input type="checkbox"/>	ZS240-YL	1SNK536060R0000	5	366.00

Main technical data

Connecting capacity		IEC	UL	CSA	Mounting instructions	
					Rail	TH 35-7.5, TH 35-15
Main circuit with 1 conductor per clamp	Rigid: Solid/Stranded	50 ... 300 mm ²	0 ... 500 Kcmil	0 ... 500 Kcmil	Main circuit	
	Flexible without ferrule	50 ... 240 mm ²			Wire stripping length	38 mm 1.496 in
	Flexible with insulated ferrule				Tool	Allen key Ø 8 mm Ø 0.315 in
Derivation with 1 conductor per clamp	Rigid: Solid/Stranded	0.5 ... 16 mm ²	20 ... 8 AWG	20 ... 8 AWG	Torque	25 Nm 221.3 lb.in
	Flexible without ferrule	0.5 ... 10 mm ²	20 ... 8 Kcmil	20 ... 8 Kcmil	Derivation	
	Gauge	B6			Wire stripping length	12 mm 0.47 in
Rated current / Rated cross section					Tool	Flat screwdriver Ø 4 mm Ø 0.157 in
Main circuit		Copper 415 A / 240 mm ²	380 A / 500 Kcmil	380 A / 500 Kcmil	Torque	1.2 Nm ... 1.4 Nm 10.6 lb.in ... 12.3 lb.in
Derivation		Aluminium 271 / 500 Kcmil	271 / 500 Kcmil	271 / 500 Kcmil		
Derivation		57 A / 10 mm ²	50 A / 8 AWG	50 A / 8 AWG		
Rated short-time withstand current (1s)		28800 A				
Rated voltage		V AC 1000 V	1000 V	1000 V		
V DC		1500				
Impulse withstand voltage		12000 V				
Protection		IP10	NEMA 1			
Increased safety Ex e		1000 V 415 A IEC/EN 60079-7 - IM2 II 2 GD Ex eb I/II/III				

The connecting capacity data for one Rigid: Solid/Stranded, or one Flexible conductor (when applicable) is a mandatory information required by IEC, UL and CSA standards (Copper conductors). All other data are provided as supplementary information only. For more details, please consult our CB, UL or CSA certificates and technical datasheet available on <http://www.TE.com>



Accessories

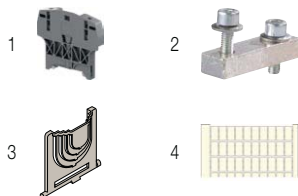

Description	Color	Type	Part Number	Pkg qty	Weight (1 pce)
1 End stops	Dark grey <input type="checkbox"/>	BAZH1	1SNK900102R0000	20	24.00
2 Jumper bars		BJMI36.2	1SNA206126R2500	1	170.00
		BJMI36.3	1SNA206223R0600	1	260.00
3 Protecting covers		CPBP2	1SNA399787R0500	20	1.30
4 Terminal block markers		RC1010	1SNA238000R1600	10	1.30
		MG-CPM 13 41791	1SNB041791R0612	1680	0.27
		MC812	1SNK160000R0000	22	10.00
		MC812PA	1SNK169999R0000	20	14.00
		Grey <input type="checkbox"/>	UMH	1SNK900611R0000	10

Complete list of accessories is indicated in the terminal block datasheet including end stops.

Some accessories such as jumper bars may modify the terminal block's ratings: Complete information available in the accessories section of the catalog.

Technical data valid for copper conductors only.

ZS4-PE screw clamp terminal blocks

Ground - 5.2 mm 0.205 in spacing

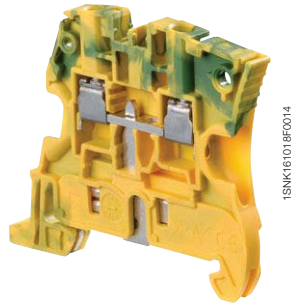

ZS4-PE

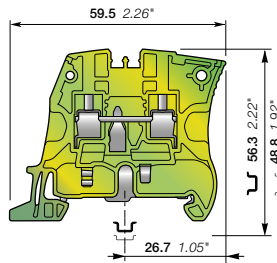

5.2 mm 0.205 in spacing

Description

Improve the safety of your installation in the event of a short-circuit thanks to our screwless rail contact:

- Rail contact non operator dependent,
- Performances above the requirements of IEC 60947-7-2 terminal block standard,
- Secured snap on or remove from the rail.

Ordering details

Description	Color	Type	Part Number	Pkg qty	Weight (1 pce) g
Ground Screwless rail connection	Green-yellow	ZS4-PE	1SNK505150R0000	20	12.10

Main technical data

Connecting capacity		IEC	UL - CSA	Mounting instructions	
1 conductor per clamp	Rigid: Solid/Stranded	0.2 ... 4 mm ²	24 ... 12 AWG	Rail	TH 35-7.5, TH 35-15
	Flexible without ferrule	0.22 ... 4 mm ²	24 ... 12 AWG	Wire stripping length	10.5 mm 0.412 in
	Flexible with non insulated ferrule	0.22 ... 4 mm ²	24 ... 12 AWG		
	Flexible with insulated ferrule	0.22 ... 2.5 mm ²	24 ... 14 AWG		
	Gauge	A3-B3		Tool	Flat screwdriver Ø 3.5 mm Ø 0.138 in
Rated cross section		4 mm ²	12 AWG	Torque	0.6 Nm ± 0.1 5.31 lb.in ± 0.885
Rated short-time withstand current (1s)		480 A	396 A		
Protection		IP20	NEMA 1		
Explosive atmosphere classification		IM2 II 2 GD Ex eb I/IIIC - Class I, Zone 1, AEx e II, Ex e II U			

The connecting capacity data for one Rigid: Solid/Stranded, or one Flexible conductor (when applicable) is a mandatory information required by IEC, UL and CSA standards (Copper conductors). All other data are provided as supplementary information only. For more details, please consult our CB, UL or CSA certificates and technical datasheet available on <http://www.TE.com>



Accessories

Description	Color	Type	Part Number	Pkg qty	Weight (1 pce) g
1 End stops	Dark grey	BAM4	1SNK900001R0000	50	14.00
2 End sections	Dark grey	ES4	1SNK505910R0000	20	2.20
3 Circuit separators	Dark grey	CS-R1	1SNK900103R0000	20	5.20
4 Terminal block markers	White	MG-CPM 13 41790	1SNB041790R0512	1960	0.23
		MC512	1SNK140000R0000	22	9.00
		MC512PA	1SNK149999R0000	20	10.00
Universal wire markers holder	Grey	UMH	1SNK900611R0000	10	0.20

Complete list of accessories is indicated in the terminal block datasheet including end stops. Some accessories such as jumper bars may modify the terminal block's ratings: Complete information available in the accessories section of the catalog.

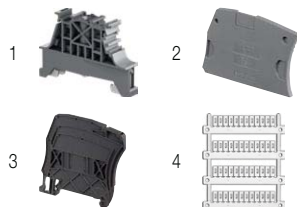

Technical data valid for copper conductors only.

ZS6-PE screw clamp terminal blocks

Ground - 6 mm 0.236 in spacing

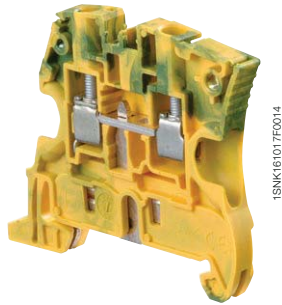

ZS6-PE

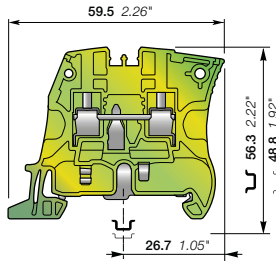

6 mm 0.236 in spacing

Description

Improve the safety of your installation in the event of a short-circuit thanks to our screwless rail contact:

- Rail contact non operator dependent,
- Performances above the requirements of IEC 60947-7-2 terminal block standard,
- Secured snap on or remove from the rail.

Ordering details

Description	Color	Type	Part Number	Pkg qty	Weight (1 pce)
Ground Screwless rail connection	Green-yellow	ZS6-PE	1SNK506150R0000	20	13.70 g

Main technical data

Connecting capacity		IEC	UL - CSA	Mounting instructions	
1 conductor per clamp	Rigid: Solid/Stranded	0.2 ... 6 mm ²	24 ... 10 AWG	Rail	TH 35-7.5, TH 35-15
	Flexible without ferrule	0.2 ... 6 mm ²		Wire stripping length	10.5 mm 0.412 in
	Flexible with non insulated ferrule	0.22 ... 4 mm ²	24 ... 12 AWG		
	Flexible with insulated ferrule	0.22 ... 4 mm ²	24 ... 12 AWG		
	Gauge	A4-B3		Tool	Flat screwdriver Ø 4 mm Ø 0.157 in
Rated cross section		6 mm ²	10 AWG	Torque	0.85 Nm ± 0.15 7.52 lb.in ± 1.33
Rated short-time withstand current (1s)		720 A	636 A		
Protection		IP20	NEMA 1		
Explosive atmosphere classification		IM2 II 2 GD Ex eb III/IIIC - Class I, Zone 1, AEx e II, Ex e II U			

The connecting capacity data for one Rigid: Solid/Stranded, or one Flexible conductor (when applicable) is a mandatory information required by IEC, UL and CSA standards (Copper conductors). All other data are provided as supplementary information only. For more details, please consult our CB, UL or CSA certificates and technical datasheet available on <http://www.TE.com>



Accessories

Description	Color	Type	Part Number	Pkg qty	Weight (1 pce)
1 End stops 10 mm 0.394 in	Dark grey	BAM4	1SNK900001R0000	50	14.00
2 End sections 2.2 mm 0.087 in	Dark grey	ES4	1SNK505910R0000	20	2.20
3 Circuit separators 3 mm 0.118 in	Dark grey	CS-R1	1SNK900103R0000	20	5.20
4 Terminal block markers	White	MG-CPM 13 41791	1SNB041791R0612	1680	0.27
		MC612	1SNK150000R0000	22	10.00
		MC612PA	1SNK159999R0000	20	11.00
Universal wire markers holder	Grey	UMH	1SNK900611R0000	10	0.20

Complete list of accessories is indicated in the terminal block datasheet including end stops.

Some accessories such as jumper bars may modify the terminal block's ratings: Complete information available in the accessories section of the catalog.

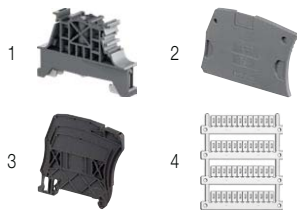

Technical data valid for copper conductors only.

ZS6-3S-PE screw clamp terminal blocks

Ground with 3 connections - 6 mm 0.236 in spacing



ZS6-3S-PE

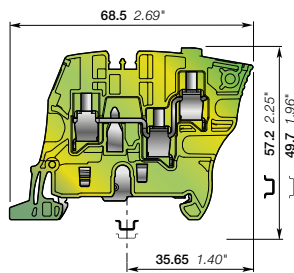

6 mm 0.236 in spacing

Description

Improve the safety of your installation in the event of a short-circuit thanks to our screwless rail contact:

- rail contact non operator dependent, secured snap on or off the rail,
- Same profile as ZS6-3S for aligned marking and identical end section.

Ordering details

Description	Color	Type	Part Number	Pkg qty	Weight (1 pce) g
Ground Screwless rail connection	Green-yellow	ZS6-3S-PE	1SNK506151R0000	25	16.20

Main technical data

Connecting capacity		IEC	UL - CSA	Mounting instructions	
1 conductor per clamp	Rigid: Solid/Stranded	0.2 ... 6 mm ²	24 ... 10 AWG	Rail	TH 35-7.5, TH 35-15
	Flexible without ferrule	0.22 ... 6 mm ²		Wire stripping length	10.5 mm 0.413 in
	Flexible with non insulated ferrule	0.22 ... 4 mm ²	24 ... 12 AWG		
	Flexible with insulated ferrule	0.22 ... 4 mm ²	24 ... 12 AWG		
Gauge		A4-B3		Tool	Flat screwdriver Ø 4 mm Ø 0.157 in
Rated cross section		4 mm ²	10 AWG	Torque	0.75 Nm ± 0.05 6.64 lb.in ± 0.443
Maximum cross section		6 mm ²			
Rated short-time withstand current (1s)		480 A	636 A		
Maximum short-time withstand current (1s)		480 A			
Protection		IP20	NEMA 1		

Explosive atmosphere classification IM2 II 2 GD Ex eb I/IIIC - Class I, Zone 1, AEx e II

The connecting capacity data for one Rigid: Solid/Stranded, or one Flexible conductor (when applicable) is a mandatory information required by IEC, UL and CSA standards (Copper conductors). All other data are provided as supplementary information only. For more details, please consult our CB, UL or CSA certificates and technical datasheet available on <http://www.TE.com>

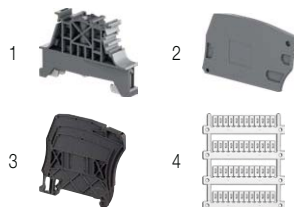

Accessories

Description	Color	Type	Part Number	Pkg qty	Weight (1 pce) g
1 End stops 10 mm 0.394 in	Dark grey	BAM4	1SNK900001R0000	50	14.00
2 End sections 2.2 mm 0.087 in	Dark grey	ES6-3S	1SNK505912R0000	20	2.50
3 Circuit separators 3 mm 0.118 in	Dark grey	CS-R1	1SNK900103R0000	20	5.20
4 Terminal block markers	White	MG-CPM 13 41791	1SNB041791R0612	1680	0.27
		MC612	1SNK150000R0000	22	10.00
		MC612PA	1SNK159999R0000	20	11.00
Universal wire markers holder	Grey	UMH	1SNK900611R0000	10	0.20

Complete list of accessories is indicated in the terminal block datasheet including end stops.

Some accessories such as jumper bars may modify the terminal block's ratings: Complete information available in the accessories section of the catalog.

Technical data valid for copper conductors only.

ZS6-4S-PE screw clamp terminal blocks

Ground with 4 connections - 6 mm 0.236 in spacing



ZS6-4S-PE

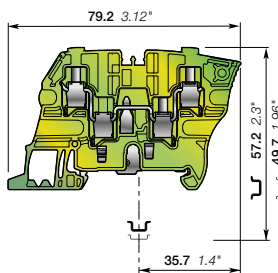

6 mm 0.236 in spacing

Description

Improve the safety of your installation in the event of a short-circuit thanks to our screwless rail contact:

- rail contact non operator dependent, secured snap on or off the rail,
- Same profile as ZS6-4S for aligned marking and identical end section.

Ordering details

Description	Color	Type	Part Number	Pkg qty	Weight (1 pce) g
Ground Screwless rail connection	Green-yellow	ZS6-4S-PE	1SNK506152R0000	25	19.40

Main technical data

Connecting capacity	IEC	UL - CSA	Mounting instructions
1 conductor per clamp			
Rigid: Solid/Stranded	0.2 ... 6 mm ²	24 ... 10 AWG	Rail
Flexible without ferrule	0.22... 6 mm ²	24 ... 10 AWG	Wire stripping length
Flexible with non insulated ferrule	0.22 ... 4 mm ²	24 ... 12 AWG	Tool
Flexible with insulated ferrule	0.22 ... 4 mm ²	24 ... 12 AWG	Torque
Gauge	A4-B3		
Rated cross section	4 mm ²	10 AWG	
Maximum cross section	6 mm ²		
Rated short-time withstand current (1s)	480 A	636 A	
Maximum short-time withstand current (1s)	480 A		
Protection	IP20	NEMA 1	

Explosive atmosphere classification IM2 II 2 GD Ex eb I/II/III - Class I, Zone 1, AEx e II

The connecting capacity data for one Rigid: Solid/Stranded, or one Flexible conductor (when applicable) is a mandatory information required by IEC, UL and CSA standards (Copper conductors). All other data are provided as supplementary information only. For more details, please consult our CB, UL or CSA certificates and technical datasheet available on <http://www.TE.com>

CE	IEC	RoHS	UL	CSA	EAC Ex	ATEX	IECEX	BR-Ex e II	Haz Loc	BV	DNV
----	-----	------	----	-----	--------	------	-------	------------	---------	----	-----

Accessories

Description	Color	Type	Part Number	Pkg qty	Weight (1 pce) g
1 End stops 10 mm 0.394 in	Dark grey	BAM4	1SNK900001R0000	50	14.00
2 End sections 2.2 mm 0.087 in	Dark grey	ES6-4S	1SNK505911R0000	20	3.10
3 Circuit separators 3 mm 0.118 in	Dark grey	CS-R1	1SNK900103R0000	20	5.20
4 Terminal block markers	White	MG-CPM 13 41791	1SNB041791R0612	1680	0.27
		MC612	1SNK150000R0000	22	10.00
		MC612PA	1SNK159999R0000	20	11.00
Universal wire markers holder	Grey	UMH	1SNK900611R0000	10	0.20

Complete list of accessories is indicated in the terminal block datasheet including end stops.

Some accessories such as jumper bars may modify the terminal block's ratings. Complete information available in the accessories section of the catalog.

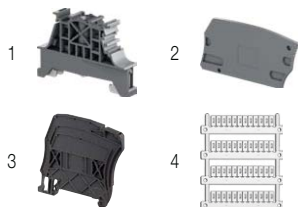

Technical data valid for copper conductors only.

ZS10-PE screw clamp terminal blocks

Ground - 8 mm 0.315 in spacing

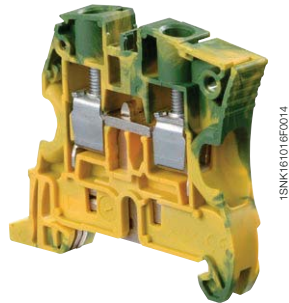

ZS10-PE

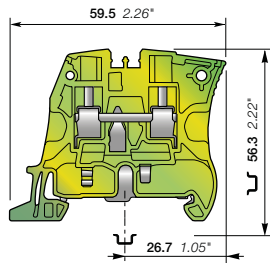

8 mm 0.315 in spacing

Description

Improve the safety of your installation in the event of a short-circuit thanks to our screwless rail contact:

- Rail contact non operator dependent,
- Performances above the requirements of IEC 60947-7-2 terminal block standard,
- Secured snap on or remove from the rail.

Ordering details

Description	Color	Type	Part Number	Pkg qty	Weight (1 pce) g
Ground Screwless rail connection	Green-yellow	ZS10-PE	1SNK508150R0000	20	22.50

Main technical data

Connecting capacity		IEC	UL - CSA	Mounting instructions	
1 conductor per clamp	Rigid: Solid/Stranded	0.5 ... 10 mm ²	24 ... 6 AWG	Rail	TH 35-7.5, TH 35-15
	Flexible without ferrule	0.5 ... 10 mm ²		Wire stripping length	12 mm 0.472 in
	Flexible with non insulated ferrule	0.5 ... 10 mm ²	24 ... 8 AWG		
	Flexible with insulated ferrule	0.5 ... 6 mm ²	24 ... 8 AWG		
	Gauge	A5-B5		Tool	Flat screwdriver Ø 4 mm Ø 0.157 in
Rated cross section		10 mm ²	6 AWG	Torque	1.3 Nm ± 0.3 11.5 lb.in ± 2.65
Rated short-time withstand current (1s)		1200 A	1596 A		
Protection		IP20	NEMA 1		
Explosive atmosphere classification		IM2 II 2 GD Ex eb I/IIIC - Class I, Zone 1, AEx e II, Ex e II U			

The connecting capacity data for one Rigid: Solid/Stranded, or one Flexible conductor (when applicable) is a mandatory information required by IEC, UL and CSA standards (Copper conductors). All other data are provided as supplementary information only. For more details, please consult our CB, UL or CSA certificates and technical datasheet available on <http://www.TE.com>



Accessories

Description	Color	Type	Part Number	Pkg qty	Weight (1 pce) g
1 End stops	Dark grey	BAM4	1SNK900001R0000	50	14.00
2 End sections	Dark grey	ES4	1SNK505910R0000	20	2.20
3 Circuit separators	Dark grey	CS-R1	1SNK900103R0000	20	5.20
4 Terminal block markers	White	MG-CPM 13 41791	1SNB041791R0612	1680	0.27
		MC812	1SNK160000R0000	22	10.00
		MC812PA	1SNK169999R0000	20	14.00
Universal wire markers holder	Grey	UMH	1SNK900611R0000	10	0.20

Complete list of accessories is indicated in the terminal block datasheet including end stops.

Some accessories such as jumper bars may modify the terminal block's ratings: Complete information available in the accessories section of the catalog.

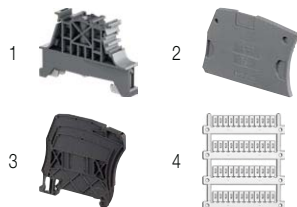

Technical data valid for copper conductors only.

ZS16-PE screw clamp terminal blocks

Ground - 10 mm 0.394 in spacing

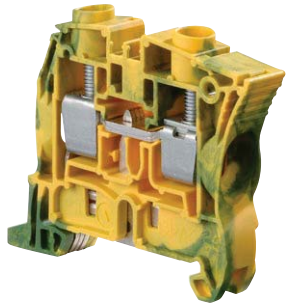

1SNK161019F0014

ZS16-PE

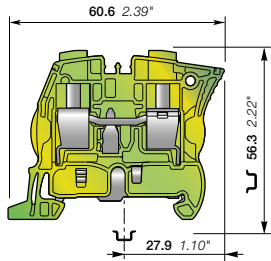

10 mm 0.394 in spacing

Description

- Improve the safety of your installation in the event of a short-circuit thanks to our screwless rail contact:
- Rail contact non operator dependent,
 - Performances above the requirements of IEC 60947-7-2 terminal block standard,
 - Secured snap on or remove from the rail,
 - PE.N function available by combining ZS16-PE with ZS16-BL and 2 poles jumper bar JB10-2.

Ordering details

Description	Color	Type	Part Number	Pkg qty	Weight (1 pce)
Ground Screwless rail connection	Green-yellow	ZS16-PE	1SNK510150R0000	20	32.00

Main technical data

Connecting capacity	IEC	UL - CSA	Mounting instructions		
1 conductor per clamp	Rigid: Solid/Stranded	0.5 ... 16 mm ²	24 ... 4 AWG	Rail	TH 35-7.5, TH 35-15
	Flexible without ferrule	0.5 ... 16 mm ²	24 ... 4 AWG	Wire stripping length	13.5 mm 0.531 in
	Flexible with non insulated ferrule	0.5 ... 16 mm ²	24 ... 4 AWG		
	Flexible with insulated ferrule	0.5 ... 10 mm ²	24 ... 8 AWG	Tool	Flat screwdriver Ø 5.5 mm Ø 0.217 in
	Gauge	A6-B6			
Rated cross section	16 mm ²	4 AWG	Torque	1.8 Nm ± 0.2 15.9 lb.in ± 1.77	
Rated short-time withstand current (1s)	1920 A	2544 A			
Protection	IP20	NEMA 1			
Explosive atmosphere classification	IM2 II 2 GD Ex eb I/II/III C - Class I, Zone 1, AEx e II, Ex e II U				

The connecting capacity data for one Rigid: Solid/Stranded, or one Flexible conductor (when applicable) is a mandatory information required by IEC, UL and CSA standards (Copper conductors). All other data are provided as supplementary information only. For more details, please consult our CB, UL or CSA certificates and technical datasheet available on <http://www.TE.com>



Accessories

Description	Color	Type	Part Number	Pkg qty	Weight (1 pce)
1 End stops	Dark grey	BAM4	1SNK900001R0000	50	14.00
2 End sections	Dark grey	ES4	1SNK505910R0000	20	2.20
3 Circuit separators	Dark grey	CS-R1	1SNK900103R0000	20	5.20
4 Terminal block markers	White	MG-CPM 13 41791	1SNB041791R0612	1680	0.27
		MC812	1SNK160000R0000	22	10.00
		MC812PA	1SNK169999R0000	20	14.00
Universal wire markers holder	Grey	UMH	1SNK900611R0000	10	0.20

Complete list of accessories is indicated in the terminal block datasheet including end stops. Some accessories such as jumper bars may modify the terminal block's ratings: Complete information available in the accessories section of the catalog.

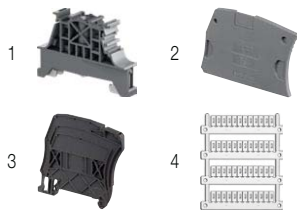

Technical data valid for copper conductors only.

ZS25-PE screw clamp terminal blocks

Ground - 12 mm 0.472 in spacing



ZS25-PE

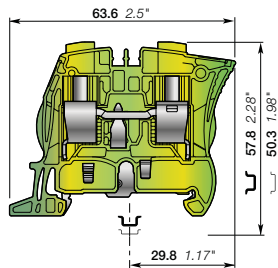

12 mm 0.472 in spacing

Description

Improve the safety of your installation in the event of a short-circuit thanks to our screwless rail contact:

- rail contact non operator dependent, secured snap on or off the rail,
- Same profile as ZS25 for aligned marking and identical end section.

Ordering details

Description	Color	Type	Part Number	Pkg qty	Weight (1 pce) g
Ground Screwless rail connection	Green-yellow	ZS25-PE	1SNK512150R000	20	38.00

Main technical data

Connecting capacity		IEC	UL - CSA	Mounting instructions	
1 conductor per clamp	Rigid: Solid/Stranded	0.5 ... 25 mm ²	24 ... 3 AWG	Rail	TH 35-7.5, TH 35-15
	Flexible without ferrule	0.5 ... 25 mm ²		Wire stripping length	13.5 mm 0.531 in
	Flexible with non insulated ferrule	0.5 ... 16 mm ²	24 ... 4 AWG		
	Flexible with insulated ferrule	0.5 ... 16 mm ²	24 ... 8 AWG		
Gauge		A6-B6		Tool	Flat screwdriver Ø 5.5 mm Ø 0.217 in
Rated cross section		16 mm ²	3 AWG	Torque	1.8 Nm ± 0.2 15.9 lb.in ± 1.77
Maximum cross section		25 mm ²			
Rated short-time withstand current (1s)		1920 A	3204 A		
Maximum short-time withstand current (1s)		3000 A			
Protection		IP20	NEMA 1		

Explosive atmosphere classification

IM2 II 2 GD Ex eb I/IIIC - Class I, Zone 1, AEx e II, Ex e II U

The connecting capacity data for one Rigid: Solid/Stranded, or one Flexible conductor (when applicable) is a mandatory information required by IEC, UL and CSA standards (Copper conductors). All other data are provided as supplementary information only. For more details, please consult our CB, UL or CSA certificates and technical datasheet available on <http://www.TE.com>

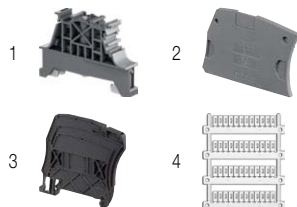

Accessories

Description	Color	Type	Part Number	Pkg qty	Weight (1 pce) g
1 End stops	Dark grey	BAM4	1SNK900001R000	50	14.00
2 End sections	Dark grey	ES4	1SNK505910R000	20	2.20
3 Circuit separators	Dark grey	CS-R1	1SNK900103R000	20	5.20
4 Terminal block markers	White	MG-CPM 13 41791	1SNB041791R0612	1680	0.27
		MC812	1SNK160000R000	22	10.00
		MC812PA	1SNK169999R000	20	14.00
Universal wire markers holder	Grey	UMH	1SNK900611R000	10	0.20

Complete list of accessories is indicated in the terminal block datasheet including end stops.

Some accessories such as jumper bars may modify the terminal block's ratings: Complete information available in the accessories section of the catalog.

Technical data valid for copper conductors only.

ZS35-PE screw clamp terminal blocks

Ground - 16 mm 0.630 in spacing

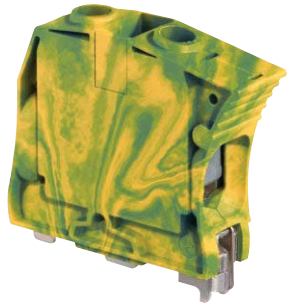

1SNK161005F0014

ZS35-PE

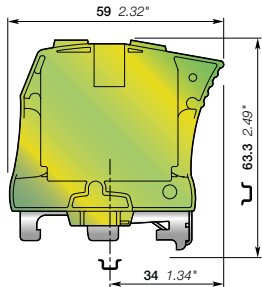

16 mm 0.630 in spacing

Description

Reliable electrical and mechanical contact with the rail that exceeds the requirements of IEC 60947-7-2 terminal block standard.

Ordering details

Description	Color	Type	Part Number	Pkg qty	Weight (1 pce)
Ground Screw rail connection	Green-yellow	ZS35-PE	1SNK516150R0000	20	81.80 g

Main technical data

Connecting capacity		IEC	UL - CSA	Mounting instructions	
1 conductor per clamp	Rigid: Solid/Stranded	6 ... 35 mm ²	10 ... 2 AWG	Rail	TH 35-7.5, TH 35-15
	Flexible without ferrule	6 ... 35 mm ²		Wire stripping length	17 mm 0.669 in
	Flexible with non insulated ferrule	4 ... 35 mm ²	10 ... 2 AWG	Tool	Flat screwdriver Ø 6.5 mm Ø 0.256 in
	Flexible with insulated ferrule	4 ... 35 mm ²	10 ... 2 AWG	Screw clamp	
Gauge		A9		Rail connection screw	Ø 5.5 Ø 0.217
Rated cross section		35 mm ²	2 AWG	Torque	2.65 Nm ± 0.15 23.4 lb.in ± 1.33
Rated short-time withstand current (1s)		4200 A	4032 A	Screw clamp	
Protection		IP10	NEMA 1	Rail connection screw	1.6 Nm ± 0.15 Nm 14.2 lb.in ± 1.33 lb.in
Explosive atmosphere classification		IM2 II 2 GD Ex eb III/IIIC - Class I, Zone 1, AEx e II			

The connecting capacity data for one Rigid: Solid/Stranded, or one Flexible conductor (when applicable) is a mandatory information required by IEC, UL and CSA standards (Copper conductors). All other data are provided as supplementary information only. For more details, please consult our CB, UL or CSA certificates and technical datasheet available on <http://www.TE.com>



Accessories

Description	Color	Type	Part Number	Pkg qty	Weight (1 pce)
1 End stops	Dark grey	BAZH1	1SNK900102R0000	20	24.00
2 Circuit separators	Dark grey	CS-R1	1SNK900103R0000	20	5.20
3 Terminal block markers	White	MG-CPM 13 41791	1SNB041791R0612	1680	0.27
		MC812	1SNK160000R0000	22	10.00
		MC812PA	1SNK169999R0000	20	14.00
	Grey	UMH	1SNK900611R0000	10	0.20

Complete list of accessories is indicated in the terminal block datasheet including end stops. Some accessories such as jumper bars may modify the terminal block's ratings: Complete information available in the accessories section of the catalog.

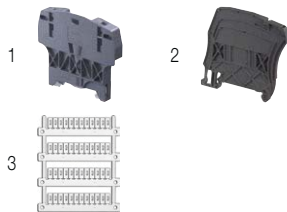

Technical data valid for copper conductors only.

ZS35-PEN screw clamp terminal blocks

Ground + neutral - 32 mm 1.260 in spacing

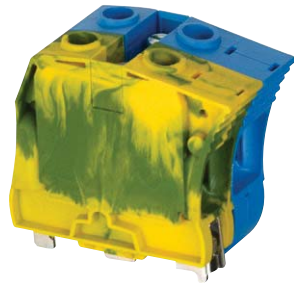

ZS35-PEN

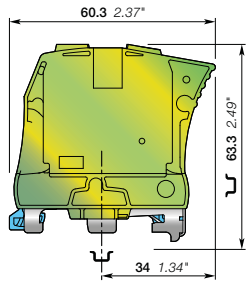

32 mm 1.260 in spacing

Description

Simplify your PE.N connection with ZS35-PE block connected to ZS35-BL through a pre-mounted jumper.

Ordering details

Description	Color	Type	Part Number	Pkg qty	Weight (1 pce) g
Ground + neutral	Green-yellow	ZS35-PEN	1SNK516170R0000	10	236.00

Main technical data

Connecting capacity		IEC	UL - CSA	Mounting instructions	
1 conductor per clamp	Rigid: Solid/Stranded	6 ... 35 mm ²		Rail	TH 35-7.5, TH 35-15
	Flexible without ferrule	6 ... 35 mm ²		Wire stripping length	17 mm 0.669 in
	Flexible with non insulated ferrule	6 ... 35 mm ²	10 ... 2 AWG	Tool	Flat screwdriver
	Flexible with insulated ferrule	6 ... 35 mm ²		Screw clamp	Ø 6.5 mm Ø 0.256 in
	Gauge	A9		Rail connection screw	Ø 5.5 Ø 0.217
Rated cross section		35 mm ²		Torque	
Rated short-time withstand current (1s)		4200 A		Screw clamp	2.65 Nm ± 0.15 23.5 lb.in ± 1.33
Protection		IP10	NEMA 1	Rail connection screw	1.6 Nm ± 0.15 Nm 14.2 lb.in ± 1.33 lb.in

The connecting capacity data for one Rigid: Solid/Stranded, or one Flexible conductor (when applicable) is a mandatory information required by IEC, UL and CSA standards (Copper conductors). All other data are provided as supplementary information only. For more details, please consult our CB, UL or CSA certificates and technical datasheet available on <http://www.TE.com>

--	--	--	--	--	--	--	--	--	--

Accessories



Description	Color	Type	Part Number	Pkg qty	Weight (1 pce) g
1 End stops	Dark grey	BAZH1	1SNK900102R0000	20	24.00
2 Terminal block markers	White	MG-CPM 13 41791	1SNB041791R0612	1680	0.27
		MC812	1SNK160000R0000	22	10.00
	Grey	MC812PA	1SNK169999R0000	20	14.00
		UMH	1SNK900611R0000	10	0.20

Complete list of accessories is indicated in the terminal block datasheet including end stops. Some accessories such as jumper bars may modify the terminal block's ratings: Complete information available in the accessories section of the catalog.

Technical data valid for copper conductors only.

ZS50-PE screw clamp terminal blocks

Ground - 16 mm 0.630 in spacing



1SNK161095V0014

ZS50-PE

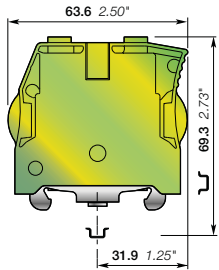

16 mm 0.630 in spacing

Description

– Reliable electrical and mechanical contact with the rail that exceeds the requirements of the IEC 60947-7-2 terminal block standard.

Ordering details

Description	Color	Type	Part Number	Pkg qty	Weight (1 pce)
Ground Screw rail connection	Green-yellow	ZS50-PE	1SNK516151R0000	20	83.00 g

Main technical data

Connecting capacity		IEC	UL - CSA	Mounting instructions	
1 conductor per clamp	Rigid: Solid/Stranded	1 ... 50 mm ²	18 ... 0 AWG	Rail	TH 35-7.5, TH 35-15
	Flexible without ferrule	1 ... 50 mm ²	18 ... 0 AWG	Wire stripping length	17 mm 0.669 in
	Flexible with non insulated ferrule	1 ... 50 mm ²	18 ... 0 AWG	Tool	Flat screwdriver Ø 6.5 mm Ø 0.256 in
	Flexible with insulated ferrule	1 ... 50 mm ²	18 ... 0 AWG	Screw clamp	
	Gauge	Dia. 11		Rail connection screw	Ø 6.5 Ø 0.256
Rated cross section		50 mm ²	0 AWG	Torque	3 Nm ± 0.50 26.6 lb.in ± 4.43
Rated short-time withstand current (1s)		6000 A	6420 A	Screw clamp	
Protection		IP10	NEMA 1	Rail connection screw	3 Nm ± 0.25 Nm 26.553 lb.in ± 2.21 lb.in
Explosive atmosphere classification		IM2 II 2 GD Ex eb III/IIIC - Class I, Zone 1, AEx e II			

The connecting capacity data for one Rigid: Solid/Stranded, or one Flexible conductor (when applicable) is a mandatory information required by IEC, UL and CSA standards (Copper conductors). All other data are provided as supplementary information only. For more details, please consult our CB, UL or CSA certificates and technical datasheet available on <http://www.TE.com>



Accessories

Description	Color	Type	Part Number	Pkg qty	Weight (1 pce)	
1 End stops	Dark grey	BAZH1	1SNK900102R0000	20	24.00	
2 Terminal block markers	White	Blank marker	MG-CPM 13 41791	1SNB041791R0612	1680	0.27
		Blank card	MC812	1SNK160000R0000	22	10.00
	Universal wire markers holder	Grey	UMH	1SNK169999R0000	20	14.00
			1SNK900611R0000	10	0.20	

Complete list of accessories is indicated in the terminal block datasheet including end stops. Some accessories such as jumper bars may modify the terminal block's ratings. Complete information available in the accessories section of the catalog.

Technical data valid for copper conductors only.

ZS70-PE screw clamp terminal blocks

Ground - 22 mm 0.866 in spacing



70 mm²
00 AWG







Description

Reliable electrical and mechanical contact with the rail that exceeds the requirements of IEC 60947-7-2 terminal block standard.

Ordering details

Description	Color	Type	Part Number	Pkg qty	Weight (1 pce) g
Ground Screw rail connection	Green-yellow	ZS70-PE	1SNK522150R0000	10	222.00

Main technical data

Connecting capacity	IEC	UL - CSA	Mounting instructions
1 conductor per clamp			
Rigid: Solid/Stranded	16 ... 95 mm ²	4 ... 00 AWG	Rail  TH 35-15
Flexible without ferrule	16 ... 70 mm ²		Wire stripping length  25 mm / 0.984 in
Flexible with non insulated ferrule	16 ... 50 mm ²		Tool  Allen key
Flexible with insulated ferrule	16 ... 50 mm ²		Screw clamp  Ø 6 mm
Gauge	B11		Rail connection screw  Ø 0.236 in
Rated cross section	70 mm ²	00 AWG	Torque  Screw clamp 6.5 Nm ± 0.5
Rated short-time withstand current (1s)	8400 A	8088 A	Rail connection screw 1.9 Nm ± 0.1 Nm
Protection	IP10	NEMA 1	16.82 lb.in ± 0.885 lb.in
Explosive atmosphere classification	IM2 II 2 GD Ex eb I/IIIC - Class I, Zone 1, AEx e II, Ex e II U		

The connecting capacity data for one Rigid: Solid/Stranded, or one Flexible conductor (when applicable) is a mandatory information required by IEC, UL and CSA standards (Copper conductors). All other data are provided as supplementary information only. For more details, please consult our CB, UL or CSA certificates and technical datasheet available on <http://www.TE.com>

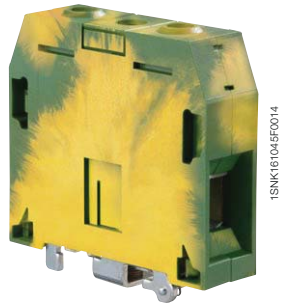

ZS70-PE

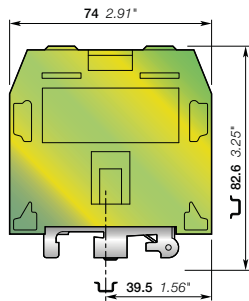

22 mm 0.866 in spacing



Accessories

Description	Color	Type	Part Number	Pkg qty	Weight (1 pce) g
1 End stops	Dark grey	BAZH1	1SNK900102R0000	20	24.00
2 Terminal block markers	White	MG-CPM 13 41791	1SNB041791R0612	1680	0.27
		MC812	1SNK160000R0000	22	10.00
		MC812PA	1SNK169999R0000	20	14.00
	Universal wire markers holder	Grey	UMH	1SNK900611R0000	10

Complete list of accessories is indicated in the terminal block datasheet including end stops. Some accessories such as jumper bars may modify the terminal block's ratings: Complete information available in the accessories section of the catalog.

Technical data valid for copper conductors only.

ZS95-PE screw clamp terminal blocks

Ground - 26 mm 1.024 in spacing

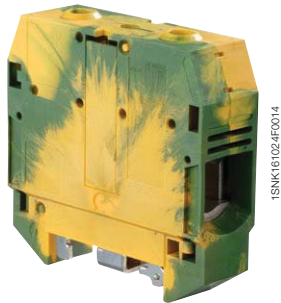

ZS95-PE

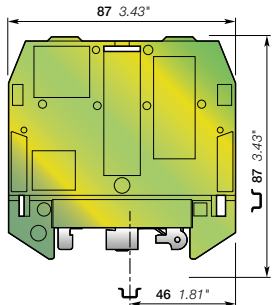

26 mm 1.024 in spacing



Description

Reliable electrical and mechanical contact with the rail that exceeds the requirements of IEC 60947-7-2 terminal block standard.

Ordering details

Description	Color	Type	Part Number	Pkg qty	Weight (1 pce)
Ground Screw rail connection	Green-yellow	ZS95-PE	1SNK526150R000	10	278.00

Main technical data

Connecting capacity		IEC	UL - CSA	Mounting instructions	
1 conductor per clamp	Rigid: Solid/Stranded	35 ... 120 mm ²	2 ... 0000 AWG	Rail	TH 35-15
	Flexible without ferrule	35 ... 95 mm ²		Wire stripping length	26 mm 1.024 in
	Flexible with non insulated ferrule	35 ... 50 mm ²		Tool	Allen key
	Flexible with insulated ferrule	35 ... 50 mm ²		Screw clamp	Ø 6 mm
	Gauge	B12		Rail connection screw	Ø 0.236 in
Rated cross section		95 mm ²	0000 AWG		
Rated short-time withstand current (1s)		11400 A	12840 A	Torque	9.25 Nm ± 0.25
Protection		IP10	NEMA 1	Screw clamp	81.7 lb.in ± 2.2
Explosive atmosphere classification		IM2 II 2 GD Ex eb III/II C - Class I, Zone 1, AEx e II, Ex e II U		Rail connection screw	1.9 Nm ± 0.1 Nm

The connecting capacity data for one Rigid: Solid/Stranded, or one Flexible conductor (when applicable) is a mandatory information required by IEC, UL and CSA standards (Copper conductors). All other data are provided as supplementary information only. For more details, please consult our CB, UL or CSA certificates and technical datasheet available on <http://www.TE.com>



Accessories

Description	Color	Type	Part Number	Pkg qty	Weight (1 pce)	
1 End stops	Dark grey	BAZH1	1SNK900102R0000	20	24.00	
2 Terminal block markers	White	Blank marker	MG-CPM 13 41791	1680	0.27	
		Blank card	MC812	1SNK160000R0000	22	10.00
			MC812PA	1SNK169999R0000	20	14.00
	Universal wire markers holder	Grey	UMH	1SNK900611R0000	10	0.20

Complete list of accessories is indicated in the terminal block datasheet including end stops. Some accessories such as jumper bars may modify the terminal block's ratings. Complete information available in the accessories section of the catalog.

Technical data valid for copper conductors only.

ZS4-S screw clamp terminal blocks

Disconnect with blade - 5.2 mm 0.205 in spacing



Description

- Ease your disconnect operations with the disconnect blade operated by hand or with a screwdriver,
- Same profile as ZS4 feed-through terminal block for aligned marking and identical end section use.

Ordering details

Description	Color	Type	Part Number	Pkg qty	Weight (1 pce) g
Disconnect Profile aligned with ZS4	Grey <input type="checkbox"/>	ZS4-S	1SNK505310R0000	50	8.60
	Blue <input type="checkbox"/>	ZS4-S-BL	1SNK505320R0000	50	8.60
	Orange <input type="checkbox"/>	ZS4-S-OR	1SNK505330R0000	50	8.60

Main technical data

Connecting capacity		IEC	UL - CSA	Mounting instructions	
1 conductor per clamp	Rigid: Solid/Stranded	0.2 ... 4 mm ²	24 ... 10 AWG	Rail	TH 35-7.5, TH 35-15
	Flexible without ferrule	0.2 ... 4 mm ²	24 ... 10 AWG	Wire stripping length	10.5 mm 0.412 in
	Flexible with non insulated ferrule	0.22 ... 4 mm ²	24 ... 10 AWG		
	Flexible with insulated ferrule	0.22 ... 2.5 mm ²	24 ... 14 AWG		
Gauge		A3-B3			
2 conductors per clamp	Rigid: Solid/Stranded	0.2 ... 1.5 mm ²	24 ... 16 AWG	Tool	Flat screwdriver Ø 3.5 mm Ø 0.138 in
	Flexible without ferrule	0.2 ... 1.5 mm ²	24 ... 16 AWG		
	Flexible with twin ferrule	0.22 ... 1.5 mm ²	24 ... 16 AWG		
Rated current / Rated cross section		25 A / 4 mm ²	25 A / 10 AWG	Torque	0.6 Nm ± 0.1 5.31 lb.in ± 0.885
Rated short-time withstand current (1s)		480 A			
Rated voltage		400 V	150 V		
Impulse withstand voltage		6000 V			
Protection		IP20	NEMA 1		



ZS4-S

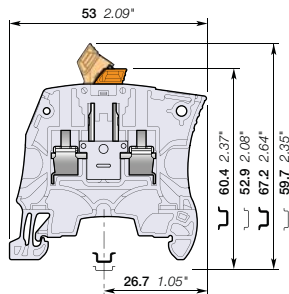

5.2 mm 0.205 in spacing

Recommendation for best usage: in horizontal assemblies, disconnect terminal blocks should be mounted with fixed foot on top (power side) so that the disconnect knife does not partially close through gravity. Furthermore, as specified per IEC 60947-7-1, disconnect terminal blocks are intended to be used for temporary disconnection at zero potential and at no load.

The connecting capacity data for one Rigid: Solid/Stranded, or one Flexible conductor (when applicable) is a mandatory information required by IEC, UL and CSA standards (Copper conductors). All other data are provided as supplementary information only. For more details, please consult our CB, UL or CSA certificates and technical datasheet available on <http://www.TE.com>

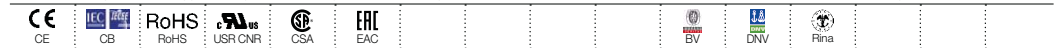

Accessories

Description	Color	Type	Part Number	Pkg qty	Weight (1 pce) g
1 End stops 10 mm 0.394 in	Dark grey <input type="checkbox"/>	BAM4	1SNK900001R0000	50	14.00
2 End sections 2.2 mm 0.087 in	Dark grey <input type="checkbox"/>	ES4	1SNK505910R0000	20	2.20
3 Lateral jumper bars 2 poles 30 A (IEC)	Grey <input type="checkbox"/>	PC5-2	1SNA113542R1000	10	1.80
		PC5-10	1SNA113544R1200	10	6.00
4 Circuit separators 3 mm 0.118 in	Dark grey <input type="checkbox"/>	CS-R1	1SNK900103R0000	20	5.20
5 Shield connectors		SHBS	1SNK900600R0000	20	3.50
6 Protecting covers 5.2 mm 0.205 in spacing	Transparent <input checked="" type="checkbox"/>	PL5	1SNK900618R0000	10	1.50
7 Terminal block markers	White <input type="checkbox"/>	MG-CPM 13 41790	1SNB041790R0512	1960	0.23
		MC512	1SNK140000R0000	22	9.00
		MC512PA	1SNK149999R0000	20	10.00
Universal wire markers holder	Grey <input type="checkbox"/>	UMH	1SNK900611R0000	10	0.20

Complete list of accessories is indicated in the terminal block datasheet including end stops.

Some accessories such as jumper bars may modify the terminal block's ratings: Complete information available in the accessories section of the catalog.



Technical data valid for copper conductors only.

ZS4-S-T screw clamp terminal blocks

Disconnect with blade - with test socket - 5.2 mm 0.205 in spacing

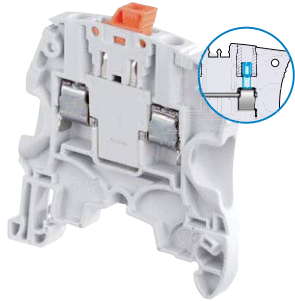
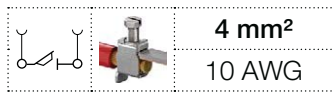

1SNK161004R0014

ZS4-S-T

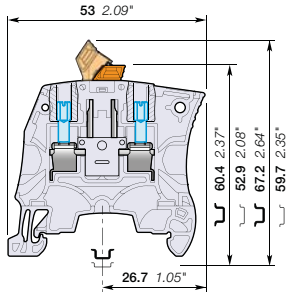

5.2 mm 0.205 in spacing

Description

- Ease your test operations with the 2 built-in test sockets,
- Screwdriver or hand operated disconnect blade,
- Same profile as ZS4 feed-through terminal block for aligned marking and identical end section use.

Ordering details

Description	Color	Type	Part Number	Pkg qty	Weight (1 pce) g
Disconnect Profile aligned with ZS4, with 2 test sockets DIA 2 mm 0.079 in	Grey <input type="checkbox"/>	ZS4-S-T2	1SNK505311R0000	50	8.90
	Blue <input type="checkbox"/>	ZS4-S-T2-BL	1SNK505321R0000	50	8.90
Profile aligned with ZS4, with 2 test sockets DIA 2.3 mm 0.091 in	Orange <input type="checkbox"/>	ZS4-S-T2-OR	1SNK505331R0000	50	8.90
	Grey <input type="checkbox"/>	ZS4-S-T2.3	1SNK505312R0000	50	8.80

Main technical data

Connecting capacity	IEC	UL - CSA	Rail		TH 35-7.5, TH 35-15	
1 conductor per clamp	Rigid: Solid/Stranded	0.2 ... 4 mm²	24 ... 10 AWG	Wire stripping length		10.5 mm 0.412 in
	Flexible without ferrule	0.22 ... 4 mm²				
	Flexible with non insulated ferrule	0.22 ... 4 mm²	24 ... 10 AWG			
	Flexible with insulated ferrule	0.22 ... 2.5 mm²	24 ... 14 AWG			
2 conductors per clamp	Gauge	A3-B3		Tool		Flat screwdriver Ø 3.5 mm Ø 0.138 in
	Rigid: Solid/Stranded	0.2 ... 1.5 mm²	24 ... 16 AWG			
	Flexible without ferrule	0.2 ... 1.5 mm²				
	Flexible with twin ferrule	0.22 ... 1.5 mm²	24 ... 16 AWG			
Rated current / Rated cross section		25 A / 4 mm²	25 A / 10 AWG	Torque		0.6 Nm ± 0.1 5.31 lb.in ± 0.885
Rated short-time withstand current (1s)		480 A				
Rated voltage		400 V	150 V			
Impulse withstand voltage		6000 V				
Protection		IP20	NEMA 1			

Mounting instructions

Recommendation for best usage: in horizontal assemblies, disconnect terminal blocks should be mounted with fixed foot on top (power side) so that the disconnect knife does not partially close through gravity. Furthermore, as specified per IEC 60947-7-1, disconnect terminal blocks are intended to be used for temporary disconnection at zero potential and at no load.

The connecting capacity data for one Rigid: Solid/Stranded, or one Flexible conductor (when applicable) is a mandatory information required by IEC, UL and CSA standards (Copper conductors). All other data are provided as supplementary information only. For more details, please consult our CB, UL or CSA certificates and technical datasheet available on <http://www.TE.com>

--	--	--	--	--	--	--	--	--	--	--	--	--	--	--	--	--	--	--	--

Accessories

Description	Color	Type	Part Number	Pkg qty	Weight (1 pce) g
1 End stops 10 mm 0.394 in	Dark grey <input type="checkbox"/>	BAM4	1SNK900001R0000	50	14.00
2 End sections 2.2 mm 0.087 in	Dark grey <input type="checkbox"/>	ES4	1SNK505910R0000	20	2.20
3 Lateral jumper bars 2 poles 30 A (IEC)	Grey <input type="checkbox"/>	PC5-2	1SNA113542R1000	10	1.80
		PC5-10	1SNA113544R1200	10	6.00
4 Circuit separators 3 mm 0.118 in	Dark grey <input type="checkbox"/>	CS-R1	1SNK900103R0000	20	5.20
5 Shield connectors		SHBS	1SNK900600R0000	20	3.50
6 Protecting covers 5.2 mm 0.205 in spacing	Transparent <input checked="" type="checkbox"/>	PL5	1SNK900618R0000	10	1.50
		MG-CPM 13 41790	1SNB041790R0512	1960	0.23
7 Terminal block markers	White <input type="checkbox"/>	MC512	1SNK140000R0000	22	9.00
		MC512PA	1SNK149999R0000	20	10.00
		Universal wire markers holder	Grey <input type="checkbox"/>	UMH	1SNK900611R0000

Complete list of accessories is indicated in the terminal block datasheet including end stops. Some accessories such as jumper bars may modify the terminal block's ratings: Complete information available in the accessories section of the catalog.



Technical data valid for copper conductors only.

ZS4-S-R1 screw clamp terminal blocks

Disconnect with blade - 6 mm 0.236 in spacing



ZS4-S-R1

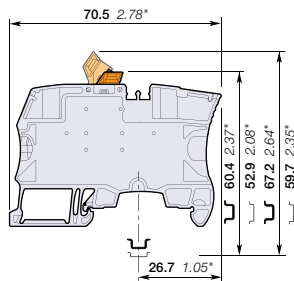

6 mm 0.236 in spacing

Description

- Simplify the alternated distribution thanks to the two jumper channels aligned with ZS4 feed-through terminal blocks,
- Ease your disconnect operations with the disconnect blade operated by hand or with a screwdriver.

Ordering details

Description	Color	Type	Part Number	Pkg qty	Weight (1 pce) g
Disconnect Profile aligned with ZS4-SF	Grey	ZS4-S-R1	1SNK506310R0000	50	13.20
	Blue	ZS4-S-R1-BL	1SNK506320R0000	50	13.20
	Orange	ZS4-S-R1-OR	1SNK506330R0000	50	13.20

Main technical data

Connecting capacity		IEC	UL - CSA	Mounting instructions	
1 conductor per clamp	Rigid: Solid/Stranded	0.2 ... 4 mm ²	24 ... 10 AWG	Rail	 TH 35-7.5, TH 35-15
	Flexible without ferrule	0.22 ... 4 mm ²			
	Flexible with non insulated ferrule	0.22 ... 4 mm ²	24 ... 12 AWG	Wire stripping length	 10.5 mm 0.412 in
	Flexible with insulated ferrule	0.22 ... 4 mm ²	24 ... 12 AWG		
	Gauge	A3-B3			
2 conductors per clamp	Rigid: Solid/Stranded	0.2 ... 1.5 mm ²	24 ... 16 AWG	Tool	 Flat screwdriver Ø 3.5 mm Ø 0.138 in
	Flexible without ferrule	0.2 ... 1.5 mm ²			
	Flexible with twin ferrule	0.22 ... 1.5 mm ²	24 ... 16 AWG		
Rated current / Rated cross section		26 A / 4 mm ²	26 A / 10 AWG	Torque	 0.6 Nm ± 0.1 5.31 lb.in ± 0.885
Rated short-time withstand current (1s)		480 A			
Rated voltage		400 V	150 V		
Impulse withstand voltage		6000 V			
Protection		IP20	NEMA 1		

Recommendation for best usage: in horizontal assemblies, disconnect terminal blocks should be mounted with fixed foot on top (power side) so that the disconnect knife does not partially close through gravity. Furthermore, as specified per IEC 60947-7-1, disconnect terminal blocks are intended to be used for temporary disconnection at zero potential and at no load.

The connecting capacity data for one Rigid: Solid/Stranded, or one Flexible conductor (when applicable) is a mandatory information required by IEC, UL and CSA standards (Copper conductors). All other data are provided as supplementary information only. For more details, please consult our CB, UL or CSA certificates and technical datasheet available on <http://www.TE.com>

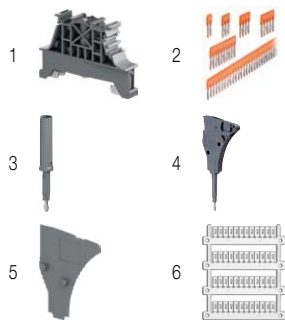
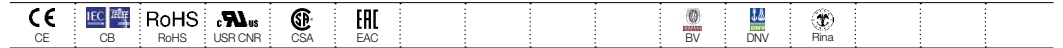

Accessories

Description	Color	Type	Part Number	Pkg qty	Weight (1 pce) g	
1 End stops	Dark grey	BAM4	1SNK900001R0000	50	14.00	
2 Jumper bars	Orange	2 poles	JB6-2	1SNK906302R0000	50	1.30
		3 poles	JB6-3	1SNK906303R0000	50	2.10
		4 poles	JB6-4	1SNK906304R0000	50	2.90
		5 poles	JB6-5	1SNK906305R0000	50	3.60
		10 poles	JB6-10	1SNK906310R0000	20	7.40
3 Test adapters	Dark grey	For test plugs DIA 2 mm 0.079 in	TP2	1SNK900203R0000	20	1.70
		For test plugs DIA 4 mm 0.157 in	TP4	1SNK900205R0000	20	2.40
4 Test connectors	Dark grey	TC5-R1	1SNK900201R0000	10	5.20	
5 Spacers	Dark grey	ES-TC6	1SNK900105R0000	10	0.80	
6 Terminal block markers	White	Blank marker	MG-CPM 13 41791	1SNB041791R0612	1680	0.27
		Blank card	MC612	1SNK150000R0000	22	10.00
			MC612PA	1SNK159999R0000	20	11.00
		Universal wire markers holder	UMH	1SNK900611R0000	10	0.20

Complete list of accessories is indicated in the terminal block datasheet including end stops. Some accessories such as jumper bars may modify the terminal block's ratings: Complete information available in the accessories section of the catalog.

Technical data valid for copper conductors only.

ZS4-S-T-R1 screw clamp terminal blocks

Disconnect with blade - with test socket - 6 mm 0.236 in spacing



ZS4-S-T-R1

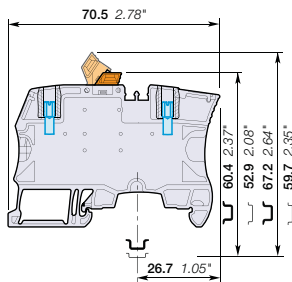

6 mm 0.236 in spacing

Description

- Ease your test operations with the 2 built-in test sockets,
- Screwdriver or hand operated disconnect blade,
- Simplify the alternated distribution thanks to the two jumper channels aligned with ZS4 feed-through terminal blocks.

Ordering details

Description	Color	Type	Part Number	Pkg qty	Weight (1 pce) g
Disconnect Profile aligned with ZS4-SF, with 2 test sockets DIA 2 mm 0.079 in	Grey	ZS4-S-T2-R1	1SNK506311R0000	50	14.20
	Blue	ZS4-S-T2-R1-BL	1SNK506321R0000	50	14.20
Profile aligned with ZS4-SF, with 2 test sockets DIA 2.3 mm 0.091 in	Orange	ZS4-S-T2-R1-OR	1SNK506331R0000	50	14.20
	Grey	ZS4-S-T2.3-R1	1SNK506312R0000	50	14.20

Main technical data

Connecting capacity	IEC	UL - CSA	Mounting instructions
1 conductor per clamp	Rigid: Solid/Stranded	0.2 ... 4 mm ²	24 ... 10 AWG
	Flexible without ferrule	0.22 ... 4 mm ²	
	Flexible with non insulated ferrule	0.22 ... 4 mm ²	24 ... 12 AWG
	Flexible with insulated ferrule	0.22 ... 4 mm ²	24 ... 12 AWG
2 conductors per clamp	Rigid: Solid/Stranded	0.2 ... 1.5 mm ²	24 ... 16 AWG
	Flexible without ferrule	0.22 ... 1.5 mm ²	24 ... 16 AWG
Rated current / Rated cross section		26 A / 4 mm ²	26 A / 10 AWG
Rated short-time withstand current (1s)		480 A	
Rated voltage		400 V	150 V
Impulse withstand voltage		6000 V	
Protection		IP20	NEMA 1
Wire stripping length			TH 35-7.5, TH 35-15 10.5 mm 0.412 in
Tool			Flat screwdriver Ø 3.5 mm Ø 0.138 in
Torque			0.6 Nm ± 0.1 5.31 lb.in ± 0.885

Recommendation for best usage: in horizontal assemblies, disconnect terminal blocks should be mounted with fixed foot on top (power side) so that the disconnect knife does not partially close through gravity. Furthermore, as specified per IEC 60947-7-1, disconnect terminal blocks are intended to be used for temporary disconnection at zero potential and at no load.

The connecting capacity data for one Rigid: Solid/Stranded, or one Flexible conductor (when applicable) is a mandatory information required by IEC, UL and CSA standards (Copper conductors). All other data are provided as supplementary information only. For more details, please consult our CB, UL or CSA certificates and technical datasheet available on <http://www.TE.com>

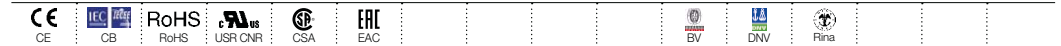

Accessories

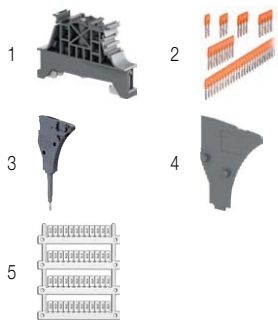

Description	Color	Type	Part Number	Pkg qty	Weight (1 pce) g	
1 End stops	Dark grey	BAM4	1SNK900001R0000	50	14.00	
2 Jumper bars	Orange	2 poles	JB6-2	1SNK906302R0000	50	1.30
		3 poles	JB6-3	1SNK906303R0000	50	2.10
		4 poles	JB6-4	1SNK906304R0000	50	2.90
		5 poles	JB6-5	1SNK906305R0000	50	3.60
		10 poles	JB6-10	1SNK906310R0000	20	7.40
3 Test connectors	Dark grey	TC5-R1	1SNK900201R0000	10	5.20	
4 Spacers	Dark grey	ES-TC6	1SNK900105R0000	10	0.80	
5 Terminal block markers	White	Blank marker	MG-CPM 13 41791	1680	0.27	
		Blank card	MC612	1SNK150000R0000	22	10.00
			MC612PA	1SNK159999R0000	20	11.00
	Universal wire markers holder	Grey	UMH	1SNK900611R0000	10	0.20

Complete list of accessories is indicated in the terminal block datasheet including end stops. Some accessories such as jumper bars may modify the terminal block's ratings: Complete information available in the accessories section of the catalog.

Technical data valid for copper conductors only.

ZS6-S screw clamp terminal blocks

Disconnect with blade - 6 mm 0.236 in spacing



ZS6-S

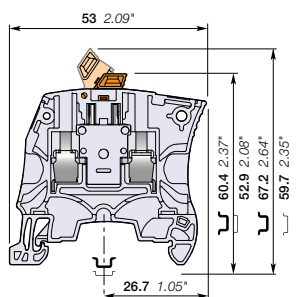

6 mm 0.236 in spacing

Description

- Ease your disconnect operations with the disconnect blade operated by hand or with a screwdriver,
- Same profile as ZS6 feed-through terminal block for aligned marking and identical end section use.

Ordering details

Description	Color	Type	Part Number	Pkg qty	Weight (1 pce) g
Disconnect Profile aligned with ZS6	Grey <input type="checkbox"/>	ZS6-S	1SNK506315R0000	50	8.60
	Blue <input type="checkbox"/>	ZS6-S-BL	1SNK506322R0000	50	8.60

Main technical data

Connecting capacity	IEC	UL - CSA	Rail	Mounting instructions	
1 conductor per clamp	Rigid: Solid/Stranded	0.2 ... 6 mm ²	24 ... 10 AWG	Wire stripping length	TH 35-7.5, TH 35-15 10.5 mm 0.412 in
	Flexible without ferrule	0.22 ... 6 mm ²	24 ... 12 AWG		
	Flexible with non insulated ferrule	0.22 ... 6 mm ²	24 ... 12 AWG	Tool	Flat screwdriver Ø 4 mm Ø 0.157 in
	Flexible with insulated ferrule	0.22 ... 4 mm ²	24 ... 12 AWG		
Gauge	A4-B3			Torque	0.85 Nm ± 0.15 7.52 lb.in ± 1.33
Rated current / Rated cross section	25 A / 4 mm ²	25 A / 10 AWG			
Maximum current / Maximum cross section	30 A / 6 mm ²				
Rated short-time withstand current (1s)	480 A				
Rated voltage	500 V	300 V			
Impulse withstand voltage	6000 V				
Protection	IP20	NEMA 1			

Recommendation for best usage: in horizontal assemblies, disconnect terminal blocks should be mounted with fixed foot on top (power side) so that the disconnect knife does not partially close through gravity. Furthermore, as specified per IEC 60947-7-1, disconnect terminal blocks are intended to be used for temporary disconnection at zero potential and at no load.

The connecting capacity data for one Rigid: Solid/Stranded, or one Flexible conductor (when applicable) is a mandatory information required by IEC, UL and CSA standards (Copper conductors). All other data are provided as supplementary information only. For more details, please consult our CB, UL or CSA certificates and technical datasheet available on <http://www.TE.com>



Accessories

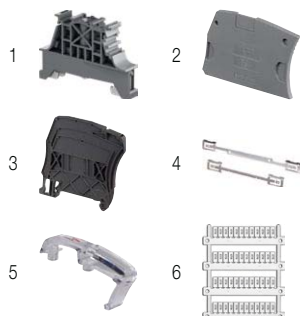

Description	Color	Type	Part Number	Pkg qty	Weight (1 pce) g
1 End stops 10 mm 0.394 in	Dark grey <input checked="" type="checkbox"/>	BAM4	1SNK900001R0000	50	14.00
2 End sections 2.2 mm 0.087 in	Dark grey <input checked="" type="checkbox"/>	ES4	1SNK505910R0000	20	2.20
3 Circuit separators 3 mm 0.118 in	Dark grey <input checked="" type="checkbox"/>	CS-R1	1SNK900103R0000	20	5.20
4 Shield connectors		SHBS	1SNK900600R0000	20	3.50
5 Protecting covers 6 mm 0.236 in spacing	Transparent <input checked="" type="checkbox"/>	PL6	1SNK900619R0000	10	1.80
6 Terminal block markers	Blank marker	MG-CPM 13 41791	1SNB041791R0612	1680	0.27
	Blank card	MC612	1SNK150000R0000	22	10.00
		MC612PA	1SNK159999R0000	20	11.00
Universal wire markers holder	Grey <input type="checkbox"/>	UMH	1SNK900611R0000	10	0.20

Complete list of accessories is indicated in the terminal block datasheet including end stops. Some accessories such as jumper bars may modify the terminal block's ratings: Complete information available in the accessories section of the catalog.

Technical data valid for copper conductors only.

ZS6-S-4S-T screw clamp terminal blocks

Disconnect with blade - with test socket screws - 6 mm 0.236 in spacing

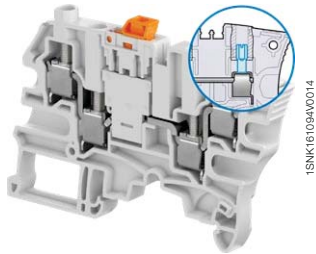

ZS6-S-4S-T

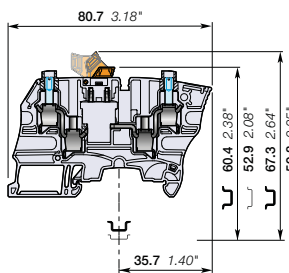

6 mm 0.236 in spacing

Description

- Recommended for energy markets and highly demanding applications requiring that only one conductor be connected per clamp,
- Ease your disconnect and test operations with the two built-in test socket screws,
- Simplify the alternated distribution thanks to the jumper channel.

Ordering details

Description	Color	Type	Part Number	Pkg qty	Weight (1 pce)
Disconnect with 2 test sockets DIA 2 mm 0,079 in	Grey <input type="checkbox"/>	ZS6-S-4S-T2	1SNK506316R0000	50	18.40

Main technical data

Connecting capacity		IEC	UL - CSA	Mounting instructions	
1 conductor per clamp	Rigid: Solid/Stranded	0.2 ... 6 mm ²	24 ... 10 AWG	Rail	TH 35-7.5, TH 35-15
	Flexible without ferrule	0.22... 6 mm ²		Wire stripping length	10.5 mm 0.413 in
	Flexible with non insulated ferrule	0.22 ... 4 mm ²	24 ... 12 AWG	Tool	Flat screwdriver Ø 4 mm Ø 0.157 in
	Flexible with insulated ferrule	0.22 ... 4 mm ²	24 ... 12 AWG		
Gauge		A4-B3		Torque	0.85 Nm ± 0.15 7.52 lb.in ± 1.33
2 conductors per clamp	Rigid: Solid/Stranded	0.2 ... 2.5 mm ²	24 ... 14 AWG		
	Flexible without ferrule	0.2 ... 2.5 mm ²			
	Flexible with twin ferrule	0.22 ... 2.5 mm ²	24 ... 14 AWG		
Rated current / Rated cross section		27 A / 4 mm ²	28 A / 10 AWG		
Rated short-time withstand current (1s)		480 A			
Rated voltage		500 V	300 V		
Impulse withstand voltage		6000 V			
Protection		IP20	NEMA 1		

Recommendation for best usage: in horizontal assemblies, disconnect terminal blocks should be mounted with fixed foot on top (power side) so that the disconnect knife does not partially close through gravity. Furthermore, as specified per IEC 60947-7-1, disconnect terminal blocks are intended to be used for temporary disconnection at zero potential and at no load.

The connecting capacity data for one Rigid: Solid/Stranded, or one Flexible conductor (when applicable) is a mandatory information required by IEC, UL and CSA standards (Copper conductors). All other data are provided as supplementary information only. For more details, please consult our CB, UL or CSA certificates and technical datasheet available on <http://www.TE.com>



Accessories

Description	Color	Type	Part Number	Pkg qty	Weight (1 pce)
1 End stops	Dark grey <input type="checkbox"/>	BAM4	1SNK900001R0000	50	14.00
2 End sections	Dark grey <input type="checkbox"/>	ES6-4S	1SNK505911R0000	20	3.10
3 Jumper bars	Orange <input type="checkbox"/>	2 poles	1SNK906302R0000	50	1.30
		3 poles	1SNK906303R0000	50	2.10
		4 poles	1SNK906304R0000	50	2.90
		5 poles	1SNK906305R0000	50	3.60
		10 poles	1SNK906310R0000	20	7.40
4 Circuit separators	Dark grey <input type="checkbox"/>	CS-R1	1SNK900103R0000	20	5.20
5 Test adapters	Dark grey <input type="checkbox"/>	For test plugs DIA 2 mm 0.079 in	1SNK900203R0000	20	1.70
		For test plugs DIA 4 mm 0.157 in	1SNK900205R0000	20	2.40
6 Test connectors	Dark grey <input type="checkbox"/>	TC5-R1	1SNK900201R0000	10	5.20
7 Spacers	Dark grey <input type="checkbox"/>	ES-TC6	1SNK900105R0000	10	0.80
8 Terminal block markers	White <input type="checkbox"/>	Blank marker	1SNB041791R0612	1680	0.27
		Blank card	1SNK150000R0000	22	10.00
			1SNK159999R0000	20	11.00
			1SNK900611R0000	10	0.20
Universal wire markers holder		Grey <input type="checkbox"/>	UMH		

Complete list of accessories is indicated in the terminal block datasheet including end stops. Some accessories such as jumper bars may modify the terminal block's ratings: Complete information available in the accessories section of the catalog.

Technical data valid for copper conductors only.

ZS10-S screw clamp terminal blocks

Disconnect with blade - 8 mm 0.315 in spacing



ZS10-S

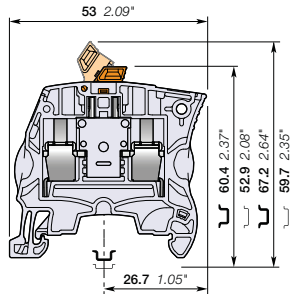

8 mm 0.315 in spacing

Description

- Ease your disconnect operations with the disconnect blade operated by hand or with a screwdriver,
- Same profile as ZS10 feed-through terminal block for aligned marking and identical end section use.

Ordering details

Description	Color	Type	Part Number	Pkg qty	Weight (1 pce) g
Disconnect Profile aligned with ZS10	Grey <input type="checkbox"/>	ZS10-S	1SNK508315R0000	50	8.60
	Blue <input type="checkbox"/>	ZS10-S-BL	1SNK508320R0000	50	8.60

Main technical data

Connecting capacity	IEC	UL - CSA	Rail	Wire stripping length	TH 35-7.5, TH 35-15
1 conductor per clamp	Rigid: Solid/Stranded	0.2 ... 10 mm ²	24 ... 6 AWG	12 mm 0.472 in	
	Flexible without ferrule	0.22 ... 10 mm ²			
	Flexible with non insulated ferrule	0.22 ... 10 mm ²	24 ... 12 AWG		
	Flexible with insulated ferrule	0.22 ... 6 mm ²	24 ... 12 AWG		
Gauge	A5-B5				
2 conductors per clamp	Rigid: Solid/Stranded	0.5 ... 4 mm ²	20 ... 12 AWG	Tool	Flat screwdriver Ø 4 mm Ø 0.157 in
	Flexible without ferrule	0.5 ... 4 mm ²			
	Flexible with twin ferrule	0.5 ... 4 mm ²	20 ... 12 AWG		
Rated current / Rated cross section	25 A / 4 mm ²	25 A / 6 AWG			
Maximum current / Maximum cross section	42 A / 10 mm ²				
Rated short-time withstand current (1s)	480 A			Torque	1.3 Nm ± 0.3 11.5 lb.in ± 2.65
Rated voltage	630 V	300 V			
Impulse withstand voltage	6000 V				
Protection	IP20	NEMA 1			

Mounting instructions

Recommendation for best usage: in horizontal assemblies, disconnect terminal blocks should be mounted with fixed foot on top (power side) so that the disconnect knife does not partially close through gravity. Furthermore, as specified per IEC 60947-7-1, disconnect terminal blocks are intended to be used for temporary disconnection at zero potential and at no load.

The connecting capacity data for one Rigid: Solid/Stranded, or one Flexible conductor (when applicable) is a mandatory information required by IEC, UL and CSA standards (Copper conductors). All other data are provided as supplementary information only. For more details, please consult our CB, UL or CSA certificates and technical datasheet available on <http://www.TE.com>

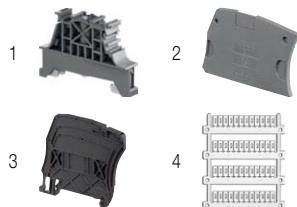

Accessories

Description	Color	Type	Part Number	Pkg qty	Weight (1 pce) g
1 End stops 10 mm 0.394 in	Dark grey <input checked="" type="checkbox"/>	BAM4	1SNK900001R0000	50	14.00
2 End sections 2.2 mm 0.087 in	Dark grey <input checked="" type="checkbox"/>	ES4	1SNK505910R0000	20	2.20
3 Circuit separators 3 mm 0.118 in	Dark grey <input checked="" type="checkbox"/>	CS-R1	1SNK900103R0000	20	5.20
4 Terminal block markers	White <input type="checkbox"/>	MG-CPM 13 41791	1SNB041791R0612	1680	0.27
		MC812	1SNK160000R0000	22	10.00
		MC812PA	1SNK169999R0000	20	14.00
Universal wire markers holder	Grey <input type="checkbox"/>	UMH	1SNK900611R0000	10	0.20

Complete list of accessories is indicated in the terminal block datasheet including end stops.

Some accessories such as jumper bars may modify the terminal block's ratings: Complete information available in the accessories section of the catalog.

Technical data valid for copper conductors only.

ZS4-SP screw clamp terminal blocks

Disconnect with plug - 5.2 mm 0.205 in spacing

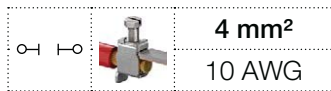

ZS4-SP

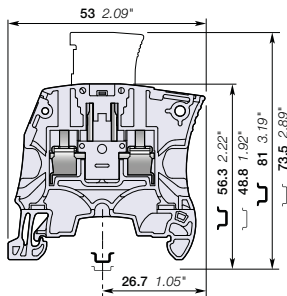

5.2 mm 0.205 in spacing

Description

- Save time with our screwless component holder plug,
- Same profile as ZS4 feed-through terminal block for aligned marking and identical end section use.

Ordering details

Description	Color	Type	Part Number	Pkg qty	Weight (1 pce)
Disconnect Profile aligned with ZS4, plug delivered separately	Grey <input type="checkbox"/>	ZS4-SP	1SNK505313R0000	50	8.20

Main technical data

Connecting capacity		IEC	UL - CSA	Mounting instructions	
1 conductor per clamp	Rigid: Solid/Stranded	0.2 ... 4 mm ²	24 ... 10 AWG	Rail	TH 35-7.5, TH 35-15
	Flexible without ferrule	0.22 ... 4 mm ²		Wire stripping length	10.5 mm 0.412 in
	Flexible with non insulated ferrule	0.22 ... 4 mm ²	24 ... 10 AWG	Tool	Flat screwdriver Ø 3.5 mm Ø 0.138 in
	Flexible with insulated ferrule	0.22 ... 2.5 mm ²	24 ... 14 AWG		
Gauge		A3-B3		Torque	0.6 Nm ± 0.1 5.31 lb.in ± 0.885
2 conductors per clamp	Rigid: Solid/Stranded	0.2 ... 1.5 mm ²	24 ... 16 AWG		
	Flexible without ferrule	0.2 ... 1.5 mm ²	24 ... 16 AWG		
Flexible with twin ferrule		0.22 ... 1.5 mm ²	24 ... 16 AWG		
Rated current / Rated cross section		18 A / 2.5 mm ²	18 A / 10 AWG		
Rated short-time withstand current (1s)		300 A			
Rated voltage		400 V	150 V		
Impulse withstand voltage		6000 V			
Protection		IP20	NEMA 1		

The connecting capacity data for one Rigid: Solid/Stranded, or one Flexible conductor (when applicable) is a mandatory information required by IEC, UL and CSA standards (Copper conductors). All other data are provided as supplementary information only. For more details, please consult our CB, UL or CSA certificates and technical datasheet available on <http://www.TE.com>

CE	RoHS	UL	CSA	EAC					
CE	RoHS	UL	CSA	EAC					

Accessories

Description	Color	Type	Part Number	Pkg qty	Weight (1 pce)
1 End stops 10 mm 0.394 in	Dark grey <input checked="" type="checkbox"/>	BAM4	1SNK900001R0000	50	14.00
2 End sections 2.2 mm 0.087 in	Dark grey <input checked="" type="checkbox"/>	ES4	1SNK505910R0000	20	2.20
3 Lateral jumper bars 2 poles 30 A (IEC)	Grey <input type="checkbox"/>	PC5-2	1SNA113542R1000	10	1.80
		PC5-10	1SNA113544R1200	10	6.00
4 Shield connectors		SHBS	1SNK900600R0000	20	3.50
5 Component plugs Components in series with circuit	Dark grey <input checked="" type="checkbox"/>	PG5	1SNK900401R0000	20	3.50
6 Disconnect plugs Equipped with linking bar	Orange <input checked="" type="checkbox"/>	PG5-R1	1SNK900402R0000	20	3.50
7 Terminal block markers	White <input type="checkbox"/>	MG-CPM 13 41790	1SNB041790R0512	1960	0.23
		MC512	1SNK140000R0000	22	9.00
		MC512PA	1SNK149999R0000	20	10.00
Universal wire markers holder	Grey <input type="checkbox"/>	UMH	1SNK900611R0000	10	0.20

Complete list of accessories is indicated in the terminal block datasheet including end stops. Some accessories such as jumper bars may modify the terminal block's ratings: Complete information available in the accessories section of the catalog.



Technical data valid for copper conductors only.

ZS4-SP-T2 screw clamp terminal blocks

Disconnect with plug - with test socket - 5.2 mm 0.205 in spacing



4 mm²
10 AWG



1SNK161098F0014

ZS4-SP-T2

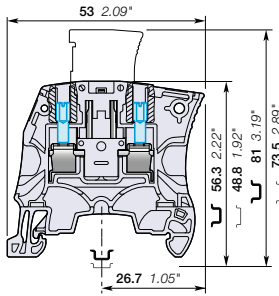

5.2 mm 0.205 in spacing

Description

- Ease your test operations with the 2 built-in test sockets DIA 2 mm 0.079 in,
- Save time with our screwless component holder plug,
- Same profile as ZS4 feed-through terminal block for aligned marking and identical end section use.

Ordering details

Description	Color	Type	Part Number	Pkg qty	Weight (1 pce)
Disconnect Profile aligned with ZS4, with 2 test sockets DIA 2 mm 0.079 in, plug delivered separately	Grey <input type="checkbox"/>	ZS4-SP-T2	1SNK505314R0000	50	8.40 g

Main technical data

Connecting capacity	IEC	UL - CSA	Mounting instructions		
			Rail	Wire stripping length	TH 35-7.5, TH 35-15
1 conductor per clamp	Rigid: Solid/Stranded	0.2 ... 4 mm ²	24 ... 10 AWG		10.5 mm 0.412 in
	Flexible without ferrule	0.22 ... 4 mm ²	24 ... 10 AWG		
	Flexible with non insulated ferrule	0.22 ... 4 mm ²	24 ... 10 AWG		
	Flexible with insulated ferrule	0.22 ... 2.5 mm ²	24 ... 14 AWG		
Gauge		A3-B3			
2 conductors per clamp	Rigid: Solid/Stranded	0.2 ... 1.5 mm ²	24 ... 16 AWG		Flat screwdriver Ø 3.5 mm Ø 0.138 in
	Flexible without ferrule	0.2 ... 1.5 mm ²	24 ... 16 AWG		
	Flexible with twin ferrule	0.22 ... 1.5 mm ²	24 ... 16 AWG		
Rated current / Rated cross section		18 A / 2.5 mm ²	18 A / 10 AWG		
Rated short-time withstand current (1s)		300 A			0.6 Nm ± 0.1 5.31 lb.in ± 0.885
Rated voltage		400 V	150 V		
Impulse withstand voltage		6000 V			
Protection		IP20	NEMA 1		

The connecting capacity data for one Rigid: Solid/Stranded, or one Flexible conductor (when applicable) is a mandatory information required by IEC, UL and CSA standards (Copper conductors). All other data are provided as supplementary information only. For more details, please consult our CB, UL or CSA certificates and technical datasheet available on <http://www.TE.com>

CE	RoHS	UL	CSA	EAC															

Accessories

Description	Color	Type	Part Number	Pkg qty	Weight (1 pce)
1 End stops 10 mm 0.394 in	Dark grey <input checked="" type="checkbox"/>	BAM4	1SNK900001R0000	50	14.00 g
2 End sections 2.2 mm 0.087 in	Dark grey <input checked="" type="checkbox"/>	ES4	1SNK505910R0000	20	2.20 g
3 Lateral jumper bars 2 poles 30 A (IEC)	Grey <input type="checkbox"/>	PC5-2	1SNA113542R1000	10	1.80 g
		PC5-10	1SNA113544R1200	10	6.00 g
4 Shield connectors		SHBS	1SNK900600R0000	20	3.50 g
5 Component plugs Components in series with circuit	Dark grey <input checked="" type="checkbox"/>	PG5	1SNK900401R0000	20	3.50 g
6 Disconnect plugs Equipped with linking bar	Orange <input checked="" type="checkbox"/>	PG5-R1	1SNK900402R0000	20	3.50 g
7 Terminal block markers	White <input type="checkbox"/>	MG-CPM 13 41790	1SNB041790R0512	1960	0.23 g
		MC512	1SNK140000R0000	22	9.00 g
		MC512PA	1SNK149999R0000	20	10.00 g
		Universal wire markers holder	Grey <input type="checkbox"/>	UMH	1SNK900611R0000

Complete list of accessories is indicated in the terminal block datasheet including end stops. Some accessories such as jumper bars may modify the terminal block's ratings: Complete information available in the accessories section of the catalog.

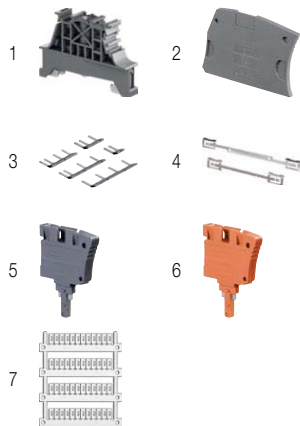

Technical data valid for copper conductors only.

ZS4-SP-R1 screw clamp terminal blocks

Disconnect with plug - 6 mm 0.236 in spacing



ZS4-SP-R1

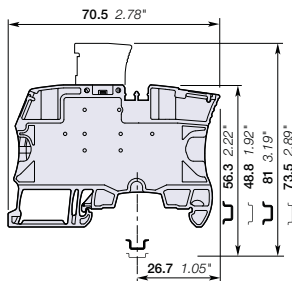

6 mm 0.236 in spacing

Description

- Simplify the alternated distribution between feed-through and disconnect circuits thanks to the two aligned jumper channels,
- Save time with our screwless component holder plug.

Ordering details

Description	Color	Type	Part Number	Pkg qty	Weight (1 pce) g
Disconnect Profile aligned with ZS4-SF, plug delivered separately	Grey <input type="checkbox"/>	ZS4-SP-R1	1SNK506313R0000	50	14.20

Main technical data

Connecting capacity		IEC	UL - CSA	Mounting instructions	
1 conductor per clamp	Rigid: Solid/Stranded	0.2 ... 4 mm ²	24 ... 10 AWG	Rail	TH 35-7.5, TH 35-15
	Flexible without ferrule	0.22 ... 4 mm ²	24 ... 12 AWG	Wire stripping length	10.5 mm 0.412 in
	Flexible with non insulated ferrule	0.22 ... 4 mm ²	24 ... 12 AWG	Tool	Flat screwdriver Ø 3.5 mm Ø 0.138 in
	Flexible with insulated ferrule	0.22 ... 4 mm ²	24 ... 12 AWG		
Gauge		A3-B3		Torque	0.6 Nm ± 0.1 5.31 lb.in ± 0.885
2 conductors per clamp	Rigid: Solid/Stranded	0.2 ... 1.5 mm ²	24 ... 16 AWG		
	Flexible without ferrule	0.2 ... 1.5 mm ²	24 ... 16 AWG		
	Flexible with twin ferrule	0.22 ... 1.5 mm ²	24 ... 16 AWG		
Rated current / Rated cross section		18 A / 2.5 mm ²	20 A / 10 AWG		
Rated short-time withstand current (1s)		300 A			
Rated voltage		400 V	150 V		
Impulse withstand voltage		6000 V			
Protection		IP20	NEMA 1		

The connecting capacity data for one Rigid: Solid/Stranded, or one Flexible conductor (when applicable) is a mandatory information required by IEC, UL and CSA standards (Copper conductors). All other data are provided as supplementary information only. For more details, please consult our CB, UL or CSA certificates and technical datasheet available on <http://www.TE.com>

--	--	--	--	--

Accessories

Description	Color	Type	Part Number	Pkg qty	Weight (1 pce) g	
1 End stops	Dark grey <input type="checkbox"/>	BAM4	1SNK900001R0000	50	14.00	
2 Jumper bars	Orange <input type="checkbox"/>	2 poles	JB6-2	1SNK906302R0000	50	1.30
		3 poles	JB6-3	1SNK906303R0000	50	2.10
		4 poles	JB6-4	1SNK906304R0000	50	2.90
		5 poles	JB6-5	1SNK906305R0000	50	3.60
		10 poles	JB6-10	1SNK906310R0000	20	7.40
3 Test adapters	Dark grey <input type="checkbox"/>	For test plugs DIA 2 mm 0.079 in	TP2	1SNK900203R0000	20	1.70
		For test plugs DIA 4 mm 0.157 in	TP4	1SNK900205R0000	20	2.40
4 Test connectors	Dark grey <input type="checkbox"/>	End module, 5.2 mm 0.205 in	TC5-R1	1SNK900201R0000	10	5.20
5 Spacers	Dark grey <input type="checkbox"/>	0.8 mm 0.031 in	ES-TC6	1SNK900105R0000	10	0.80
6 Component plugs	Dark grey <input type="checkbox"/>	Components in series with circuit	PG5	1SNK900401R0000	20	3.50
7 Disconnect plugs	Orange <input type="checkbox"/>	Equipped with linking bar	PG5-R1	1SNK900402R0000	20	3.50
8 Terminal block markers	White <input type="checkbox"/>	Blank marker	MG-CPM 13 41791	1SNB041791R0612	1680	0.27
		Blank card	MC612	1SNK150000R0000	22	10.00
		Universal wire markers holder	UMH	1SNK159999R0000	20	11.00
	Grey <input type="checkbox"/>		UMH	1SNK900611R0000	10	0.20

Complete list of accessories is indicated in the terminal block datasheet including end stops. Some accessories such as jumper bars may modify the terminal block's ratings: Complete information available in the accessories section of the catalog.

Technical data valid for copper conductors only.

ZS4-SP-T2-R1 screw clamp terminal blocks

Disconnect with plug - with test socket - 6 mm 0.236 in spacing

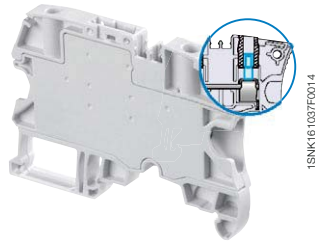

1SNK16 1037TC014

ZS4-SP-T2-R1

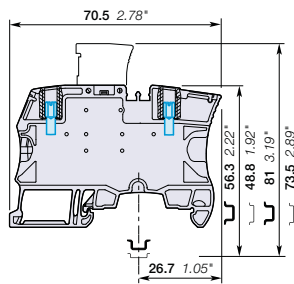

6 mm 0.236 in spacing

Description

- Ease your test operations with the 2 built-in test sockets DIA 2 mm 0.079 in,
- Save time with our screwless component holder plug,
- Simplify the distribution between feed-through and disconnect circuits thanks to the two aligned jumper channels.

Ordering details

Description	Color	Type	Part Number	Pkg qty	Weight (1 pce)
Disconnect Profile aligned with ZS4-SF, with 2 test sockets DIA 2 mm 0.079 in, plug delivered separately	Grey <input type="checkbox"/>	ZS4-SP-T2-R1	1SNK506314R0000	50	14.20 g

Main technical data

Connecting capacity		IEC	UL - CSA	Mounting instructions	
1 conductor per clamp	Rigid: Solid/Stranded	0.2 ... 4 mm²	24 ... 10 AWG	Rail	TH 35-7.5, TH 35-15
	Flexible without ferrule	0.22 ... 4 mm²		Wire stripping length	10.5 mm 0.412 in
	Flexible with non insulated ferrule	0.22 ... 4 mm²	24 ... 12 AWG		
	Flexible with insulated ferrule	0.22 ... 4 mm²	24 ... 12 AWG		
	Gauge	A3-B3			
2 conductors per clamp	Rigid: Solid/Stranded	0.2 ... 1.5 mm²	24 ... 16 AWG	Tool	Flat screwdriver Ø 3.5 mm Ø 0.138 in
	Flexible without ferrule	0.2 ... 1.5 mm²			
	Flexible with twin ferrule	0.22 ... 1.5 mm²	24 ... 16 AWG		
Rated current / Rated cross section		18 A / 2.5 mm²	20 A / 10 AWG		
Rated short-time withstand current (1s)		300 A		Torque	0.6 Nm ± 0.1 5.31 lb.in ± 0.85
Rated voltage		400 V	150 V		
Impulse withstand voltage		6000 V			
Protection		IP20	NEMA 1		

The connecting capacity data for one Rigid: Solid/Stranded, or one Flexible conductor (when applicable) is a mandatory information required by IEC, UL and CSA standards (Copper conductors). All other data are provided as supplementary information only. For more details, please consult our CB, UL or CSA certificates and technical datasheet available on <http://www.TE.com>

CE	RoHS	UL	CSA	EAC

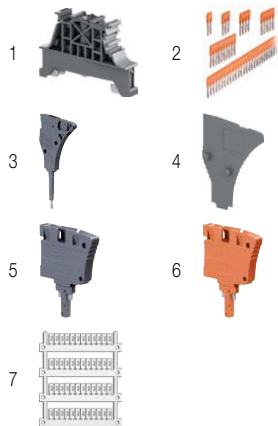

Accessories

Description	Color	Type	Part Number	Pkg qty	Weight (1 pce)	
1 End stops	Dark grey <input checked="" type="checkbox"/>	BAM4	1SNK900001R0000	50	14.00 g	
2 Jumper bars	Orange <input checked="" type="checkbox"/>	2 poles	JB6-2	1SNK906302R0000	50	1.30
		3 poles	JB6-3	1SNK906303R0000	50	2.10
		4 poles	JB6-4	1SNK906304R0000	50	2.90
		5 poles	JB6-5	1SNK906305R0000	50	3.60
		10 poles	JB6-10	1SNK906310R0000	20	7.40
3 Test connectors	Dark grey <input checked="" type="checkbox"/>	TC5-R1	1SNK900201R0000	10	5.20	
4 Spacers	Dark grey <input checked="" type="checkbox"/>	ES-TC6	1SNK900105R0000	10	0.80	
5 Component plugs	Dark grey <input checked="" type="checkbox"/>	PG5	1SNK900401R0000	20	3.50	
6 Disconnect plugs	Orange <input checked="" type="checkbox"/>	PG5-R1	1SNK900402R0000	20	3.50	
7 Terminal block markers	White <input type="checkbox"/>	Blank marker	MG-CPM 13 41791	1SNB041791R0612	1680	0.27
		Blank card	MC612	1SNK150000R0000	22	10.00
			MC612PA	1SNK159999R0000	20	11.00
	Universal wire markers holder	Grey <input type="checkbox"/>	UMH	1SNK900611R0000	10	0.20

Complete list of accessories is indicated in the terminal block datasheet including end stops. Some accessories such as jumper bars may modify the terminal block's ratings: Complete information available in the accessories section of the catalog.

Technical data valid for copper conductors only.

ZS10-SP screw clamp terminal blocks

Disconnect with plug - 8 mm 0.315 in spacing



ZS10-SP

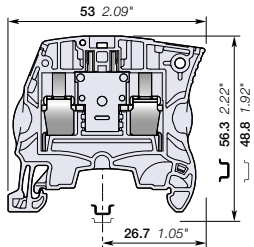

8 mm 0.315 in spacing

Description

- Save time with our screwless component holder plug,
- Same profile as ZS10 feed-through terminal block for aligned marking and identical end section use.

Ordering details

Description	Color	Type	Part Number	Pkg qty	Weight (1 pce) g
Disconnect Profile aligned with ZS10	Grey <input type="checkbox"/>	ZS10-SP	1SNK508316R0000	50	8.60

Main technical data

Connecting capacity		IEC	UL - CSA	Mounting instructions	
1 conductor per clamp	Rigid: Solid/Stranded	0.2 ... 10 mm ²	24 ... 6 AWG	Rail	TH 35-7.5, TH 35-15
	Flexible without ferrule	0.22 ... 10 mm ²	24 ... 8 AWG	Wire stripping length	12 mm 0.472 in
	Flexible with non insulated ferrule	0.22 ... 10 mm ²	24 ... 8 AWG	Tool	Flat screwdriver Ø 4 mm Ø 0.157 in
	Flexible with insulated ferrule	0.22 ... 6 mm ²	24 ... 8 AWG		
Gauge		A5-B5		Torque	1.3 Nm ± 0.3 11.5 lb.in ± 2.65
2 conductors per clamp	Rigid: Solid/Stranded	0.5 ... 4 mm ²	20 ... 12 AWG		
	Flexible without ferrule	0.5 ... 4 mm ²	20 ... 12 AWG		
	Flexible with twin ferrule	0.5 ... 4 mm ²	20 ... 12 AWG		
Rated current / Rated cross section		18 A / 2.5 mm ²	18 A / 6 AWG		
Maximum current / Maximum cross section		18 A / 10 mm ²			
Rated short-time withstand current (1s)		300 A			
Rated voltage		630 V	300 V		
Impulse withstand voltage		6000 V			
Protection		IP20		NEMA 1	

The connecting capacity data for one Rigid: Solid/Stranded, or one Flexible conductor (when applicable) is a mandatory information required by IEC, UL and CSA standards (Copper conductors). All other data are provided as supplementary information only. For more details, please consult our CB, UL or CSA certificates and technical datasheet available on <http://www.TE.com>

CE	RoHS	UR	CSA	EAC
----	------	----	-----	-----

Accessories

Description	Color	Type	Part Number	Pkg qty	Weight (1 pce) g
1 End stops 10 mm 0.394 in	Dark grey <input checked="" type="checkbox"/>	BAM4	1SNK900001R0000	50	14.00
2 End sections 2.2 mm 0.087 in	Dark grey <input checked="" type="checkbox"/>	ES4	1SNK505910R0000	20	2.20
3 Component plugs Components in series with circuit	Dark grey <input checked="" type="checkbox"/>	PG5	1SNK900401R0000	20	3.50
4 Disconnect plugs Equipped with linking bar	Orange <input checked="" type="checkbox"/>	PG5-R1	1SNK900402R0000	20	3.50
5 Terminal block markers	White <input type="checkbox"/>	MG-CPM 13 41791	1SNB041791R0612	1680	0.27
		MC812	1SNK160000R0000	22	10.00
		MC812PA	1SNK169999R0000	20	14.00
Universal wire markers holder	Grey <input type="checkbox"/>	UMH	1SNK900611R0000	10	0.20

Complete list of accessories is indicated in the terminal block datasheet including end stops. Some accessories such as jumper bars may modify the terminal block's ratings: Complete information available in the accessories section of the catalog.

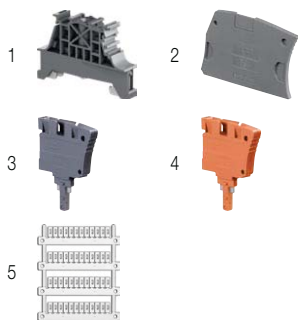

Technical data valid for copper conductors only.



SNK series, terminal blocks

Fuse protection



Optimize your control circuit protection

Our SNK series fuse terminal blocks offer a full set of features and functions to protect your control circuits with efficiency and reliability.

All terminal blocks complies with the latest evolution of the international standards IEC 60947-7-3 ("Ancillary equipment safety requirements for fuse terminal blocks.") which fixes precise temperature constraint for short-circuit and overload protection (information in the catalogue pages related to the products).

Qualified for worldwide markets and applications

Eco-designed according to international environmental standards in sustainable development.



RoHS



EAC



Select the right fuse holder for the right application

1 standard applications

The standard fuse holders feature compact dimensions while offering compatibility with 5 x 20 and 5 x 25 mm fuses. double deck terminal blocks allow efficient space reduction for panels with space constraints.

2 Expert for convenient circuit distribution

The expert fuse holders are equipped with two central jumper channels for convenient common distribution and are aligned with feed-through and disconnect terminal blocks. They facilitate alternated potential distribution and reduce wiring.

Additional features for easy trouble shooting and testing

Performant blown fuse indicators

Low leakage current (< 0.5 mA) allows the protection of low current circuits such as PLC's inputs without any risk of circuit disturbances.

Large voltage range (24/110 V and 110/250 V AC/DC) reduces the number of variants and allows adaptation to worldwide applications (24/110 V range covers North american market needs).

Easy testing

Some terminal blocks are equipped with Dia 2 mm built-in test socket screws for circuit testing while respecting the IP20 touch proof protection.



1
5x20 and 5x25 mm fuses
Compact and high density



2
5x20 and 6.3x32 mm fuses
Easy potential distribution

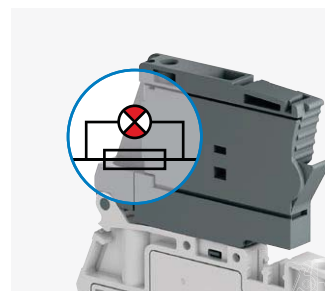

Low leakage current blown fuse indicator.
Large voltage range: (24/110 V and 110/250 V AC and DC)

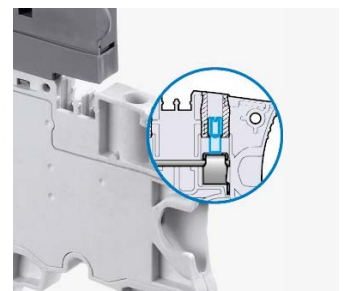

Convenient testing through built in test socket screws

1SNK16108550201

SNK series, terminal blocks

Marshalling cabinets application

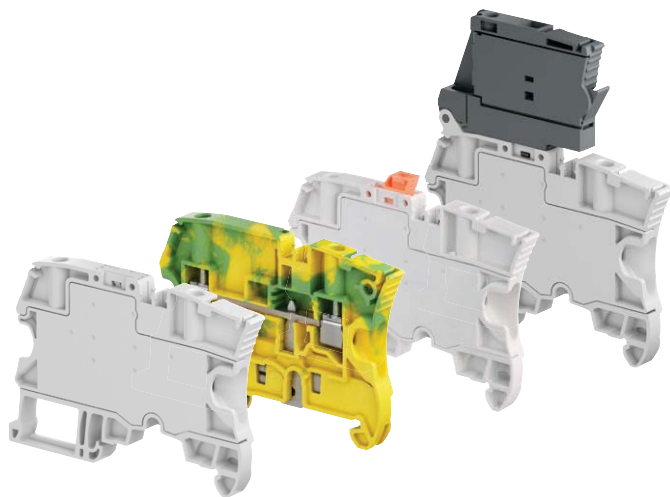

The smart choice for process automation

Large process automation applications typically require the use of a large number of digital or analog signals and sensors. Indeed, marshalling cabinets ensure an important cross wiring function, since the incoming field signal and the channel quantity of the I/O card of the controller (DCS, large PLC's) is always different. They facilitate the maintenance operations and ease the system modifications.

SNK aligned terminal blocks offering:

SNK series now features a full set of aligned terminal blocks matching the marshalling panels typical configurations. Fuse, disconnect, feed-through and ground terminal blocks with identical profile are providing compact and convenient solution. With only 6 mm spacing, two aligned screwless jumper channels, central large marking as well as aligned conductor entries, they are perfectly adapted to alternative potential distribution while still easy to connect.

Typical marshalling configurations

Digital signals

Popular potential distribution via double center channel.

Disconnect functions equipped with test points allow total isolation of circuits, ease circuit testing during start-up, test and maintenance operations.

Analog

Potential distribution for analog signals. Ground terminal blocks allow reliable connection of cable shields to the ground sparing the use of external shield bar.

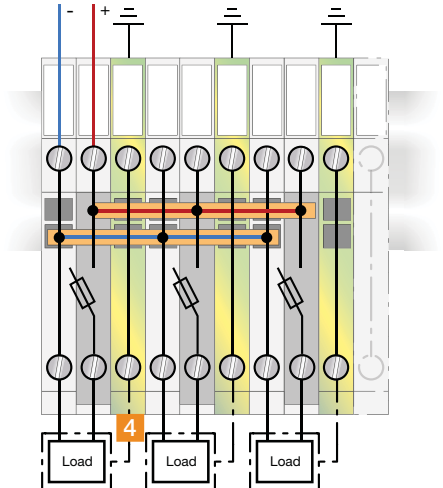
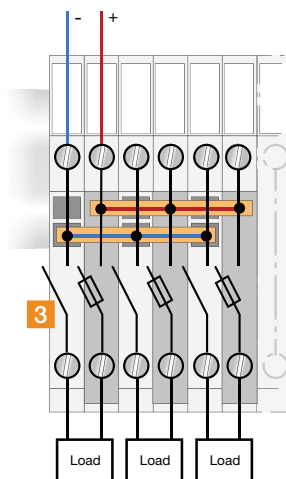
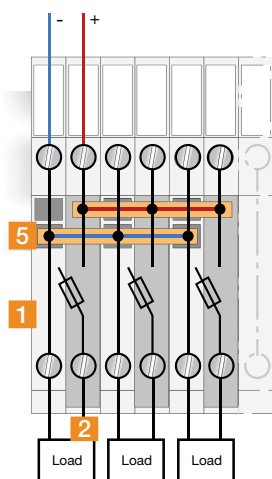

1SNK161086S0201

ZS4-SF1 screw clamp terminal blocks

For 5 x 20 and 5 x 25 fuses - 8 mm 0.315 in spacing

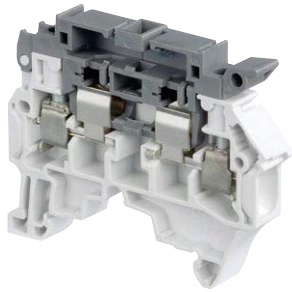

ZS4-SF1

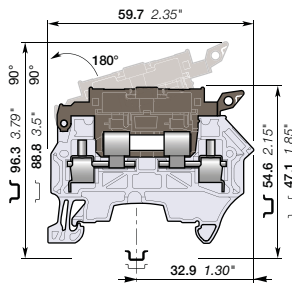

8 mm 0.315 in spacing

Description

Protect your circuit with 5x25 and 5x20 fuse terminal blocks, compliant with IEC 60947-7-3 standard (fuse not supplied with the terminal blocks).

Ordering details

Description	Color	Type	Part Number	Pkg qty	Weight (1 pce) g
Fuse	Grey, dark grey	ZS4-SF1	1SNK508410R0000	50	13.30
	Orange, dark grey	ZS4-SF1-OR	1SNK508430R0000	50	13.30

Main technical data

Connecting capacity		IEC	UL - CSA	Mounting instructions	
1 conductor per clamp	Rigid: Solid/Stranded	0.2 ... 4 mm ²	24 ... 10 AWG	Rail	TH 35-7.5, TH 35-15
	Flexible without ferrule	0.22 ... 4 mm ²		Wire stripping length	11 mm 0.432 in
	Flexible with non insulated ferrule	0.22 ... 4 mm ²	24 ... 12 AWG		
	Flexible with insulated ferrule	0.22 ... 4 mm ²	24 ... 12 AWG		
	Gauge	A3-B3			
2 conductors per clamp	Rigid: Solid/Stranded	0.2 ... 2.5 mm ²	24 ... 14 AWG	Tool	Flat screwdriver Ø 3.5 mm Ø 0.138 in
	Flexible without ferrule	0.2 ... 2.5 mm ²	24 ... 14 AWG		
	Flexible with twin ferrule	0.22 ... 2.5 mm ²	24 ... 14 AWG		
Rated current / Rated cross section		6.3 A / 4 mm ²	10 A / 10 AWG	Torque	0.6 Nm ± 0.1 5.31 lb.in ± 0.885
Rated voltage		630 V	300 V		
Impulse withstand voltage		8000 V			
Protection		IP20	NEMA 1		

Separate arrangement		Assembly composed of 1 fuse terminal block in between non fuse terminal blocks	Overload and short-circuit protection	2.5 W
			Exclusive short-circuit protection	4 W
Compound arrangement		Assembly composed of 5 fuse terminal blocks	Overload and short-circuit protection	1.6 W
			Exclusive short-circuit protection	4 W

The connecting capacity data for one Rigid: Solid/Stranded, or one Flexible conductor (when applicable) is a mandatory information required by IEC, UL and CSA standards (Copper conductors). All other data are provided as supplementary information only. For more details, please consult our CB, UL or CSA certificates and technical datasheet available on <http://www.TE.com>

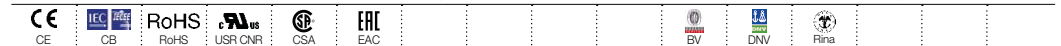

Accessories

Description	Color	Type	Part Number	Pkg qty	Weight (1 pce) g
1 End stops	Dark grey	BAM4	1SNK900001R0000	50	14.00
2 End sections	Dark grey	ES4-SF	1SNK508960R0000	20	1.80
3 Lateral jumper bars	Grey	PC81-10	1SNA173523R1100	10	5.00
4 Assembly rods		TGA8	1SNA168672R1100	10	1.00
		TGA8	1SNA168673R1200	10	1.50
		TGA8	1SNA168674R1300	10	2.00
5 Spring retaining Rings		ANT	1SNA168675R1400	10	
6 Neutral cartridge		CN5	1SNA179371R1600	10	3.9
7 Terminal block markers	White	MG-CPM 13 41791	1SNB041791R0612	1680	0.27
		MC812	1SNK160000R0000	22	10.00
		MC812PA	1SNK169999R0000	20	14.00
	Grey	UMH	1SNK900611R0000	10	0.20

Complete list of accessories is indicated in the terminal block datasheet including end stops.

Some accessories such as jumper bars may modify the terminal block's ratings: Complete information available in the accessories section of the catalog.

Technical data valid for copper conductors only.

ZS4-SF1-T screw clamp terminal blocks

For 5 x 20 and 5 x 25 fuses - with test socket - 8 mm 0.315 in spacing

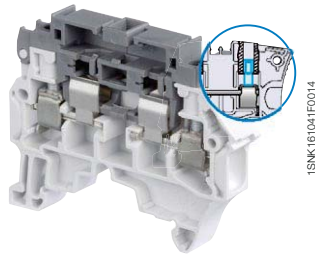

ZS4-SF1-T

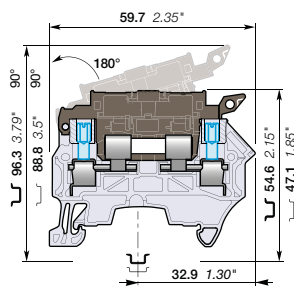

8 mm 0.315 in spacing

Description

- Protect your circuit with 5x25 and 5x20 fuse terminal blocks (fuse not supplied with the terminal blocks),
- Compliant with IEC 60947-7-3 standard,
- With built in test sockets.

Ordering details

Description	Color	Type	Part Number	Pkg qty	Weight (1 pce) g
Fuse With 2 test sockets DIA 2 mm 0.079 in	Grey, dark grey	ZS4-SF1-T2	1SNK508411R0000	50	13.30

Main technical data

Connecting capacity		IEC	UL - CSA	Mounting instructions	
1 conductor per clamp	Rigid: Solid/Stranded	0.2 ... 4 mm²	24 ... 10 AWG	Rail	TH 35-7.5, TH 35-15
	Flexible without ferrule	0.22 ... 4 mm²	24 ... 12 AWG	Wire stripping length	11 mm 0.432 in
	Flexible with non insulated ferrule	0.22 ... 4 mm²	24 ... 12 AWG		
	Flexible with insulated ferrule	0.22 ... 4 mm²	24 ... 12 AWG		
Gauge		A3-B3		Tool	Flat screwdriver Ø 3.5 mm Ø 0.138 in
2 conductors per clamp	Rigid: Solid/Stranded	0.2 ... 2.5 mm²	24 ... 14 AWG		
	Flexible without ferrule	0.2 ... 2.5 mm²	24 ... 14 AWG		
Flexible with twin ferrule		0.22 ... 2.5 mm²	24 ... 14 AWG	Torque	0.6 Nm ± 0.1 5.31 lb.in ± 0.885
Rated current / Rated cross section		6.3 A / 4 mm²	10 A / 10 AWG		
Rated voltage		630 V	300 V		
Impulse withstand voltage		8000 V			
Protection		IP20	NEMA 1		

Separate arrangement		Assembly composed of 1 fuse terminal block in between non fuse terminal blocks	Overload and short-circuit protection	2.5 W
			Exclusive short-circuit protection	4 W
Compound arrangement		Assembly composed of 5 fuse terminal blocks	Overload and short-circuit protection	1.6 W
			Exclusive short-circuit protection	4 W

The connecting capacity data for one Rigid: Solid/Stranded, or one Flexible conductor (when applicable) is a mandatory information required by IEC, UL and CSA standards (Copper conductors). All other data are provided as supplementary information only. For more details, please consult our CB, UL or CSA certificates and technical datasheet available on <http://www.TE.com>

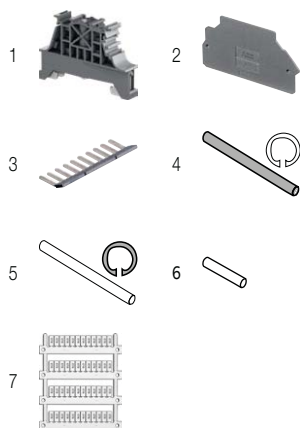
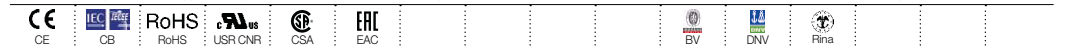

Accessories

Description	Color	Type	Part Number	Pkg qty	Weight (1 pce) g	
1 End stops	Dark grey	BAM4	1SNK900001R0000	50	14.00	
2 End sections	Dark grey	ES4-SF	1SNK508960R0000	20	1.80	
3 Lateral jumper bars	Grey	PC81-10	1SNA173523R1100	10	5.00	
4 Assembly rods		2 poles	TGA8	1SNA168672R1100	10	1.00
		3 poles	TGA8	1SNA168673R1200	10	1.50
		4 poles	TGA8	1SNA168674R1300	10	2.00
5 Spring retaining Rings		ANT	1SNA168675R1400	10		
6 Neutral cartridge		CN5	1SNA179371R1600	10	3.9	
7 Terminal block markers	White	Blank marker	MG-CPM 13 41791	1SNB041791R0612	1680	0.27
		Blank card	MC812	1SNK160000R0000	22	10.00
			MC812PA	1SNK169999R0000	20	14.00
	Grey	UMH	1SNK900611R0000	10	0.20	

Complete list of accessories is indicated in the terminal block datasheet including end stops. Some accessories such as jumper bars may modify the terminal block's ratings. Complete information available in the accessories section of the catalog.

Technical data valid for copper conductors only.

ZS4-SF1-R screw clamp terminal blocks

For 5 x 20 and 5 x 25 fuses - with blown fuse indicator - 8 mm 0.315 in spacing

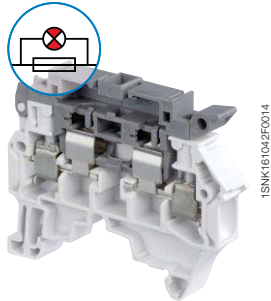

ZS4-SF1-R

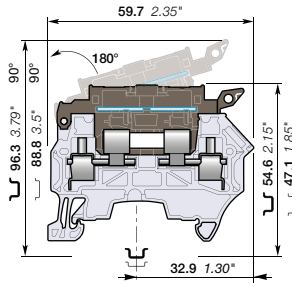

8 mm 0.315 in spacing



Description

- Protect your circuit with 5x25 and 5x20 fuse terminal blocks (fuse not supplied with the terminal blocks),
- Compliant with IEC 60947-7-3 standard,
- Quickly identify the defective circuit thanks to the blown fuse indicator (with leakage current < 0.5 mA).

Ordering details

Description	Color	Type	Part Number	Pkg qty	Weight (1 pce) g
Fuse With blown fuse indicator 115 ... 250 V AC / DC	Grey, dark grey	ZS4-SF1-R3	1SNK508414R0000	50	13.30
With blown fuse indicator 24 ... 110 V AC / DC		ZS4-SF1-R1	1SNK508412R0000	50	13.30

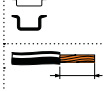
Main technical data

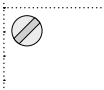
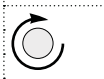
Connecting capacity	IEC	UL - CSA	Mounting instructions	
1 conductor per clamp	Rigid: Solid/Stranded Flexible without ferrule Flexible with non insulated ferrule Flexible with insulated ferrule Gauge	0.2 ... 4 mm ² 0.22 ... 4 mm ² 0.22 ... 4 mm ² 0.22 ... 4 mm ² A3-B3	24 ... 10 AWG 24 ... 12 AWG 24 ... 12 AWG	Rail  TH 35-7.5, TH 35-15 Wire stripping length  11 mm 0.432 in
2 conductors per clamp	Rigid: Solid/Stranded Flexible without ferrule Flexible with twin ferrule	0.2 ... 2.5 mm ² 0.2 ... 2.5 mm ² 0.22 ... 2.5 mm ²	24 ... 14 AWG 24 ... 14 AWG 24 ... 14 AWG	Tool  Flat screwdriver Ø 3.5 mm Ø 0.138 in
Rated current / Rated cross section		6.3 A / 4 mm ²	10 A / 10 AWG	Torque  0.6 Nm ± 0.1 5.31 lb.in ± 0.885
Rated voltage		630 V	300 V	
Impulse withstand voltage		8000 V		
Protection		IP20	NEMA 1	

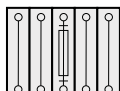
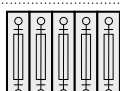
Separate arrangement		Assembly composed of 1 fuse terminal block in between non fuse terminal blocks	Overload and short-circuit protection	2.5 W
			Exclusive short-circuit protection	4 W
Compound arrangement		Assembly composed of 5 fuse terminal blocks	Overload and short-circuit protection	1.6 W
			Exclusive short-circuit protection	4 W

The connecting capacity data for one Rigid: Solid/Stranded, or one Flexible conductor (when applicable) is a mandatory information required by IEC, UL and CSA standards (Copper conductors). All other data are provided as supplementary information only. For more details, please consult our CB, UL or CSA certificates and technical datasheet available on <http://www.TE.com>

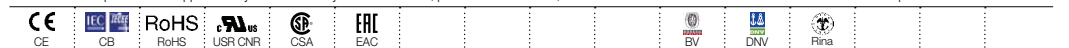

Accessories

Description	Color	Type	Part Number	Pkg qty	Weight (1 pce) g
1 End stops	Dark grey	BAM4	1SNK900001R0000	50	14.00
2 End sections	Dark grey	ES4-SF	1SNK508960R0000	20	1.80
3 Lateral jumper bars	Grey	PC81-10	1SNA173523R1100	10	5.00
4 Assembly rods		TGA8	1SNA168672R1100	10	1.00
		TGA8	1SNA168673R1200	10	1.50
		TGA8	1SNA168674R1300	10	2.00
5 Spring retaining Rings		ANT	1SNA168675R1400	10	
6 Terminal block markers	White	MG-CPM 13 41791	1SNB041791R0612	1680	0.27
		MC812	1SNK160000R0000	22	10.00
		MC812PA	1SNK169999R0000	20	14.00
	Grey	UMH	1SNK900611R0000	10	0.20

Complete list of accessories is indicated in the terminal block datasheet including end stops.

Some accessories such as jumper bars may modify the terminal block's ratings: Complete information available in the accessories section of the catalog.

Technical data valid for copper conductors only.

ZS4-SF1-R screw clamp terminal blocks

For 5 x 20 and 5 x 25 fuses - with blown fuse indicator and test sockets - 8 mm 0.315 in spacing



4 mm²
10 AWG

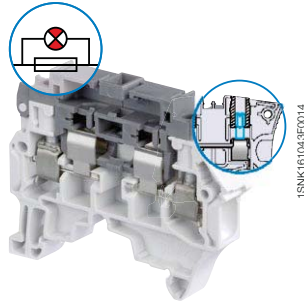

1SNK161043F0014

ZS4-SF1-R

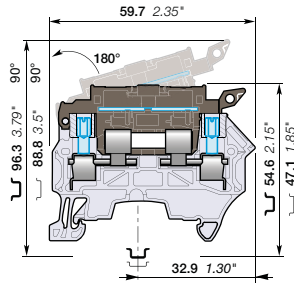

8 mm 0.315 in spacing

Description

- Protect your circuit with 5x25 and 5x20 fuse terminal blocks (fuse not supplied with the terminal blocks),
- Compliant with IEC 60947-7-3 standard,
- Ease the test with built-in test sockets,
- Quickly identify the defective circuit thanks to the blown fuse indicator (with leakage current < 0.5 mA).

Ordering details

Description	Color	Type	Part Number	Pkg qty	Weight (1 pce) g
Fuse With blown fuse indicator 115 ... 250 V AC / DC and 2 test sockets DIA 2 mm 0.079 in	Grey, dark grey	ZS4-SF1-R4	1SNK508415R0000	50	13.30
With blown fuse indicator 24 ... 110 V AC / DC and 2 test sockets DIA 2 mm 0.079 in		ZS4-SF1-R2	1SNK508413R0000	50	13.30

Main technical data

Connecting capacity	IEC	UL - CSA	Mounting instructions		
1 conductor per clamp	Rigid: Solid/Stranded	0.2 ... 4 mm ²	24 ... 10 AWG	Rail	TH 35-7.5, TH 35-15
	Flexible without ferrule	0.22 ... 4 mm ²		Wire stripping length	11 mm 0.432 in
	Flexible with non insulated ferrule	0.22 ... 4 mm ²	24 ... 12 AWG	Tool	Flat screwdriver Ø 3.5 mm Ø 0.138 in
	Flexible with insulated ferrule	0.22 ... 4 mm ²	24 ... 12 AWG		
	Gauge	A3-B3			
2 conductors per clamp	Rigid: Solid/Stranded	0.2 ... 2.5 mm ²	24 ... 14 AWG	Torque	0.6 Nm ± 0.1 5.31 lb.in ± 0.885
	Flexible without ferrule	0.2 ... 2.5 mm ²			
	Flexible with twin ferrule	0.22 ... 2.5 mm ²	24 ... 14 AWG		
Rated current / Rated cross section		6.3 A / 4 mm ²	10 A / 10 AWG		
Rated voltage		630 V	300 V		
Impulse withstand voltage		8000 V			
Protection		IP20	NEMA 1		

Separate arrangement		Assembly composed of 1 fuse terminal block in between non fuse terminal blocks	Overload and short-circuit protection	2.5 W
			Exclusive short-circuit protection	4 W
Compound arrangement		Assembly composed of 5 fuse terminal blocks	Overload and short-circuit protection	1.6 W
			Exclusive short-circuit protection	4 W

The connecting capacity data for one Rigid: Solid/Stranded, or one Flexible conductor (when applicable) is a mandatory information required by IEC, UL and CSA standards (Copper conductors). All other data are provided as supplementary information only. For more details, please consult our CB, UL or CSA certificates and technical datasheet available on <http://www.TE.com>

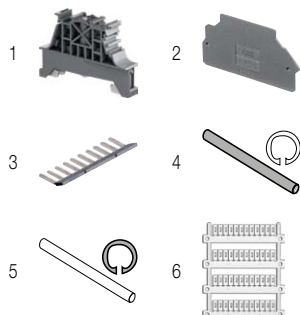
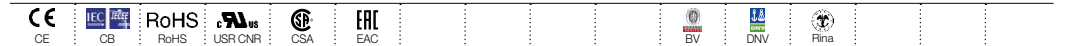

Accessories

Description	Color	Type	Part Number	Pkg qty	Weight (1 pce) g	
1 End stops	Dark grey	BAM4	1SNK90001R0000	50	14.00	
2 End sections	Dark grey	ES4-SF	1SNK508960R0000	20	1.80	
3 Lateral jumper bars	Grey	PC81-10	1SNA173523R1100	10	5.00	
4 Assembly rods		TGA8	1SNA168672R1100	10	1.00	
		TGA8	1SNA168673R1200	10	1.50	
		TGA8	1SNA168674R1300	10	2.00	
5 Spring retaining Rings		ANT	1SNA168675R1400	10		
6 Terminal block markers	Blank marker	White	MG-CPM 13 41791	1680	0.27	
	Blank card		MC812	1SNK160000R0000	22	10.00
			MC812PA	1SNK169999R0000	20	14.00
	Universal wire markers holder	Grey	UMH	1SNK900611R0000	10	0.20

Complete list of accessories is indicated in the terminal block datasheet including end stops. Some accessories such as jumper bars may modify the terminal block's ratings: Complete information available in the accessories section of the catalog.

Technical data valid for copper conductors only.

ZS4-R1 screw clamp terminal blocks

Feed-through - 8 mm 0.315 in spacing



1SNK161048FC014

ZS4-R1

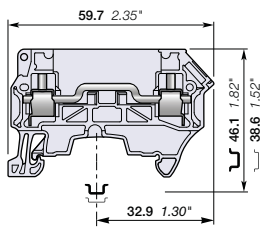

8 mm 0.315 in spacing

Description

Simplify the alternated feed-through and fuse circuits operations:

- With the same profile as the ZS4-SF1, the wiring of the alternated feed-through and fuse circuits is easier.

Ordering details

Description	Color	Type	Part Number	Pkg qty	Weight (1 pce) g
Feed-through Profile aligned with ZS4-SF1	Grey <input type="checkbox"/>	ZS4-R1	1SNK508013R0000	50	11.00

Main technical data

Connecting capacity		IEC	UL - CSA	Mounting instructions		
1 conductor per clamp		Rigid: Solid/Stranded Flexible without ferrule Flexible with non insulated ferrule Flexible with insulated ferrule Gauge	0.2 ... 4 mm ² 0.22 ... 4 mm ² 0.22 ... 4 mm ² 0.22 ... 4 mm ² A3-B3	24 ... 10 AWG 24 ... 12 AWG 24 ... 12 AWG	Rail Wire stripping length	TH 35-7.5, TH 35-15 11 mm 0.432 in
2 conductors per clamp		Rigid: Solid/Stranded Flexible without ferrule Flexible with twin ferrule	0.2 ... 2.5 mm ² 0.2 ... 2.5 mm ² 0.22 ... 2.5 mm ²	24 ... 14 AWG 24 ... 14 AWG 24 ... 14 AWG	Tool	Flat screwdriver Ø 3.5 mm Ø 0.138 in
Rated current / Rated cross section		300 A	24 A / 2.5 mm ²	26 A / 10 AWG	Torque	0.6 Nm ± 0.1 5.31 lb.in ± 0.885
Rated short-time withstand current (1s)						
Short Circuit Current Rating (with specific conditions)						
Rated voltage		800 V	300 V			
Impulse withstand voltage		6000 V				
Protection		IP20	NEMA 1			

The connecting capacity data for one Rigid: Solid/Stranded, or one Flexible conductor (when applicable) is a mandatory information required by IEC, UL and CSA standards (Copper conductors). All other data are provided as supplementary information only. For more details, please consult our CB, UL or CSA certificates and technical datasheet available on <http://www.TE.com>

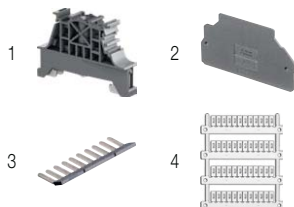

Accessories

Description	Color	Type	Part Number	Pkg qty	Weight (1 pce) g
1 End stops 10 mm 0.394 in	Dark grey <input checked="" type="checkbox"/>	BAM4	1SNK900001R0000	50	14.00
2 End sections 1.5 mm 0.059 in	Dark grey <input checked="" type="checkbox"/>	ES4-SF	1SNK508960R0000	20	1.80
3 Lateral jumper bars 10 poles 35 A (IEC)	Grey <input type="checkbox"/>	PC81-10	1SNA173523R1100	10	5.00
4 Terminal block markers	White <input type="checkbox"/>	MG-CPM 13 41791	1SNB041791R0612	1680	0.27
		MC812	1SNK160000R0000	22	10.00
		MC812PA	1SNK169999R0000	20	14.00
Universal wire markers holder	Grey <input type="checkbox"/>	UMH	1SNK900611R0000	10	0.20

Complete list of accessories is indicated in the terminal block datasheet including end stops.

Some accessories such as jumper bars may modify the terminal block's ratings. Complete information available in the accessories section of the catalog.

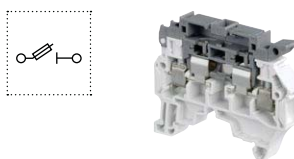

Fuse screw clamp terminal blocks

Description	Color	Type	Part Number	Pkg qty	Weight (1 pce) g
Fuse	Grey, dark grey <input type="checkbox"/>	ZS4-SF1	1SNK508410R0000	50	13.30

Technical data valid for copper conductors only.

ZS4-S-R3 screw clamp terminal blocks

Disconnect with lever - 8 mm 0.315 in spacing

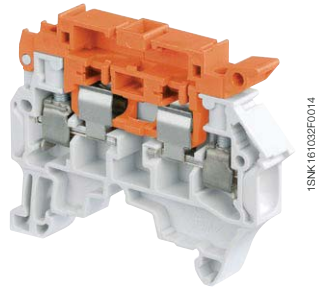

ZS4-S-R3

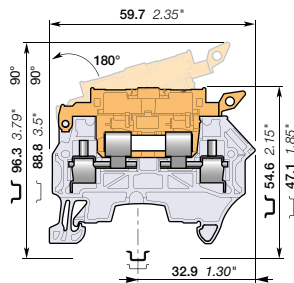

8 mm 0.315 in spacing

Description

Simplify the disconnect operations for the disconnect terminal blocks installed next to fuse terminal blocks ZS4-SF1:

- With the same profile as ZS4-SF1, the ZS4-S-R3 disconnect lever is easily operated by hand and the wiring of the alternated disconnect and fuse circuits is easier,
- Neutral cartridge CN5 5x25 included.

Ordering details

Description	Color	Type	Part Number	Pkg qty	Weight (1 pce) g
Disconnect Profile aligned with ZS4-SF1	Grey, orange	ZS4-S-R3	1SNK508416R0000	50	13.30
	Grey, blue	ZS4-S-R3-T2	1SNK508419R0000	50	13.30

Main technical data

Connecting capacity		IEC	UL - CSA	Mounting instructions	
1 conductor per clamp	Rigid: Solid/Stranded	0.2 ... 4 mm ²	24 ... 10 AWG	Rail	TH 35-7.5, TH 35-15
	Flexible without ferrule	0.22 ... 4 mm ²		Wire stripping length	11 mm 0.432 in
	Flexible with non insulated ferrule	0.22 ... 4 mm ²	24 ... 12 AWG		
	Flexible with insulated ferrule	0.22 ... 4 mm ²	24 ... 12 AWG		
2 conductors per clamp	Gauge	A3-B3		Tool	Flat screwdriver Ø 3.5 mm Ø 0.138 in
	Rigid: Solid/Stranded	0.2 ... 2.5 mm ²	24 ... 14 AWG		
	Flexible without ferrule	0.2 ... 2.5 mm ²			
	Flexible with twin ferrule	0.22 ... 2.5 mm ²	24 ... 14 AWG		
Rated current / Rated cross section		18 A / 2.5 mm ²	18 A / 10 AWG	Torque	0.6 Nm ± 0.1 5.31 lb.in ± 0.885
Maximum current / Maximum cross section		18 A / 4 mm ²			
Rated short-time withstand current (1s)		300 A			
Rated voltage		630 V	300 V		
Impulse withstand voltage		6000 V			
Protection		IP20	NEMA 1		

Recommendation for best usage: in horizontal assemblies, disconnect terminal blocks should be mounted with fixed foot on top (power side) so that the disconnect lever does not partially close through gravity. Furthermore, as specified per IEC 60947-7-1, disconnect terminal blocks are intended to be used for temporary disconnection at zero potential and at no load.

The connecting capacity data for one Rigid: Solid/Stranded, or one Flexible conductor (when applicable) is a mandatory information required by IEC, UL and CSA standards (Copper conductors). All other data are provided as supplementary information only. For more details, please consult our CB, UL or CSA certificates and technical datasheet available on <http://www.TE.com>

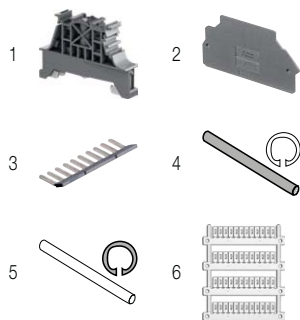
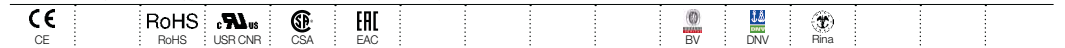

Accessories

Description	Color	Type	Part Number	Pkg qty	Weight (1 pce) g
1 End stops 10 mm 0.394 in	Dark grey	BAM4	1SNK900001R0000	50	14.00
2 End sections 1.5 mm 0.059 in	Dark grey	ES4-SF	1SNK508960R0000	20	1.80
3 Lateral jumper bars 10 poles 35 A (IEC)	Grey	PC81-10	1SNA173523R1100	10	5.00
4 Assembly rods		2 poles TGA8	1SNA168672R1100	10	1.00
		3 poles TGA8	1SNA168673R1200	10	1.50
		4 poles TGA8	1SNA168674R1300	10	2.00
5 Spring retaining Rings		ANT	1SNA168675R1400	10	
6 Terminal block markers	White	Blank marker MG-OPM 13 41791	1SNB041791R0612	1680	0.27
		Blank card MC812	1SNK160000R0000	22	10.00
		MC812PA	1SNK169999R0000	20	14.00
		Universal wire markers holder UMH	1SNK900611R0000	10	0.20

Complete list of accessories is indicated in the terminal block datasheet including end stops.

Some accessories such as jumper bars may modify the terminal block's ratings: Complete information available in the accessories section of the catalog.

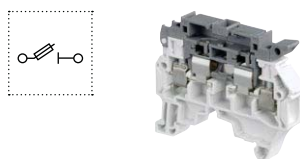

Fuse screw clamp terminal blocks

Description	Color	Type	Part Number	Pkg qty	Weight (1 pce) g
Fuse	Grey, dark grey	ZS4-SF1	1SNK508410R0000	50	13.30

Technical data valid for copper conductors only.

ZS4-SF screw clamp terminal blocks

For 5 x 20 fuses - 6 mm 0.236 in spacing

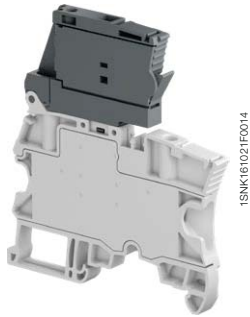

ZS4-SF

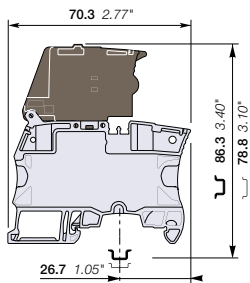

6 mm 0.236 in spacing

Description

- Protect your circuits with 5x20 fuse terminal blocks compliant with IEC 60947-7-3 standard (fuse not supplied with the terminal blocks),
- Simplify the distribution thanks to the two jumper channels aligned with ZS4 or ZS4-R2 feed-through and ZS4-S-R1 disconnect terminal blocks.

Ordering details

Description	Color	Type	Part Number	Pkg qty	Weight (1 pce) g
Fuse	Grey, dark grey	ZS4-SF	1SNK506410R0000	50	18.60

Main technical data

Connecting capacity		IEC	UL - CSA	Mounting instructions	
1 conductor per clamp	Rigid: Solid/Stranded	0.2 ... 4 mm ²	24 ... 10 AWG	Rail	TH 35-7.5, TH 35-15
	Flexible without ferrule	0.22 ... 4 mm ²		Wire stripping length	10.5 mm 0.412 in
	Flexible with non insulated ferrule	0.22 ... 4 mm ²	24 ... 12 AWG		
	Flexible with insulated ferrule	0.22 ... 4 mm ²	24 ... 12 AWG		
Gauge		A3-B3		Tool	Flat screwdriver Ø 3.5 mm Ø 0.138 in
2 conductors per clamp	Rigid: Solid/Stranded	0.2 ... 1.5 mm ²	24 ... 16 AWG		
	Flexible without ferrule	0.2 ... 1.5 mm ²			
Flexible with twin ferrule		0.22 ... 1.5 mm ²	24 ... 16 AWG	Torque	0.6 Nm ± 0.1 5.31 lb.in ± 0.885
Rated current / Rated cross section		6.3 A / 4 mm ²	10 A / 10 AWG		
Rated voltage		500 V	150 V		
Impulse withstand voltage		6000 V			
Protection		IP20	NEMA 1		

Mount your fuse safely without touching any active part: put the fuse into the hooks of the fuse holder shutter; at the closing of the shutter, the fuse is perfectly in place in the fuse holder.

Separate arrangement		Assembly composed of 1 fuse terminal block in between non fuse terminal blocks	Overload and short-circuit protection	2.5 W
			Exclusive short-circuit protection	4 W
Compound arrangement		Assembly composed of 5 fuse terminal blocks	Overload and short-circuit protection	2.5 W
			Exclusive short-circuit protection	4 W

The connecting capacity data for one Rigid: Solid/Stranded, or one Flexible conductor (when applicable) is a mandatory information required by IEC, UL and CSA standards (Copper conductors). All other data are provided as supplementary information only. For more details, please consult our CB, UL or CSA certificates and technical datasheet available on <http://www.TE.com>



Accessories

Description	Color	Type	Part Number	Pkg qty	Weight (1 pce) g
1 End stops	Dark grey	BAM4	1SNK900001R0000	50	14.00
2 Jumper bars	Orange	JB6-2	1SNK906302R0000	50	1.30
		JB6-3	1SNK906303R0000	50	2.10
		JB6-4	1SNK906304R0000	50	2.90
		JB6-5	1SNK906305R0000	50	3.60
		JB6-10	1SNK906310R0000	20	7.40
3 Test adapters	Dark grey	TP2	1SNK900203R0000	20	1.70
		TP4	1SNK900205R0000	20	2.40
4 Test connectors	Dark grey	TC5-R1	1SNK900201R0000	10	5.20
5 Spacers	Dark grey	ES-TC6	1SNK900105R0000	10	0.80
6 Terminal block markers	White	MG-CPM 13 41791	1SNB041791R0612	1680	0.27
		MC612	1SNK150000R0000	22	10.00
		MC612PA	1SNK159999R0000	20	11.00
	Universal wire markers holder	Grey	UMH	1SNK900611R0000	10

Complete list of accessories is indicated in the terminal block datasheet including end stops. Some accessories such as jumper bars may modify the terminal block's ratings: Complete information available in the accessories section of the catalog.

Technical data valid for copper conductors only.

ZS4-SF-T screw clamp terminal blocks

For 5 x 20 fuses - with test socket - 6 mm 0.236 in spacing

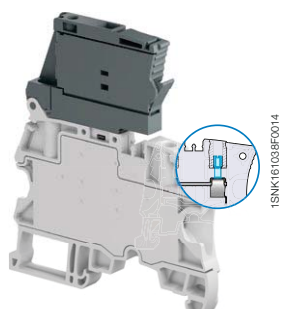

ZS4-SF-T

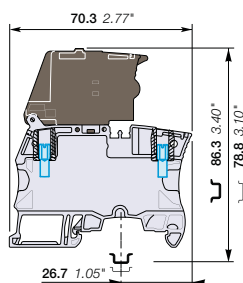

6 mm 0.236 in spacing

Description

- Protect your circuits with 5x20 fuse terminal blocks compliant with IEC 60947-7-3 standard (fuse not supplied with the terminal blocks),
- Simplify the distribution thanks to the two jumper channels aligned with ZS4 or ZS4-R2 feed-through and ZS4-S-R1 disconnect terminal blocks,
- Ease the test with built-in test socket screws.

Ordering details

Description	Color	Type	Part Number	Pkg qty	Weight (1 pce) g
Fuse With 2 test sockets DIA 2 mm 0.079 in	Grey, dark grey	ZS4-SF-T2	1SNK506411R0000	50	18.60

Main technical data

Connecting capacity		IEC	UL - CSA	Mounting instructions	
1 conductor per clamp	Rigid/ Solid/Stranded	0.2 ... 4 mm ²	24 ... 10 AWG	Rail	TH 35-7.5, TH 35-15
	Flexible without ferrule	0.22 ... 4 mm ²		Wire stripping length	10.5 mm 0.412 in
	Flexible with non insulated ferrule	0.22 ... 4 mm ²	24 ... 12 AWG		
	Flexible with insulated ferrule	0.22 ... 4 mm ²	24 ... 12 AWG		
2 conductors per clamp	Gauge	A3-B3		Tool	Flat screwdriver Ø 3.5 mm Ø 0.138 in
	Rigid/ Solid/Stranded	0.2 ... 1.5 mm ²	24 ... 16 AWG		
	Flexible without ferrule	0.2 ... 1.5 mm ²	24 ... 16 AWG		
	Flexible with twin ferrule	0.22 ... 1.5 mm ²	24 ... 16 AWG		
Rated current / Rated cross section		6.3 A / 4 mm ²	10 A / 10 AWG	Torque	0.6 Nm ± 0.1 5.31 lb.in ± 0.885
Rated voltage		500 V	150 V		
Impulse withstand voltage		6000 V			
Protection		IP20	NEMA 1		

Mount your fuse safely without touching any active part: put the fuse into the hooks of the fuse holder shutter; at the closing of the shutter, the fuse is perfectly in place in the fuse holder.

Separate arrangement		Assembly composed of 1 fuse terminal block in between non fuse terminal blocks	Overload and short-circuit protection	2.5 W
			Exclusive short-circuit protection	4 W
Compound arrangement		Assembly composed of 5 fuse terminal blocks	Overload and short-circuit protection	2.5 W
			Exclusive short-circuit protection	4 W

The connecting capacity data for one Rigid/ Solid/Stranded, or one Flexible conductor (when applicable) is a mandatory information required by IEC, UL and CSA standards (Copper conductors). All other data are provided as supplementary information only. For more details, please consult our CB, UL or CSA certificates and technical datasheet available on <http://www.TE.com>

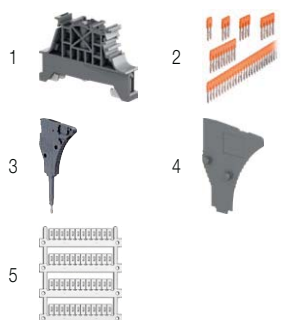
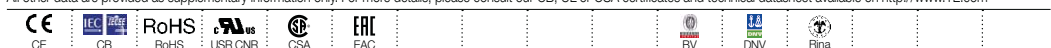

Accessories

Description	Color	Type	Part Number	Pkg qty	Weight (1 pce) g	
1 End stops	Dark grey	BAM4	1SNK900001R0000	50	14.00	
2 Jumper bars	Orange	2 poles	JB6-2	1SNK906302R0000	50	1.30
		3 poles	JB6-3	1SNK906303R0000	50	2.10
		4 poles	JB6-4	1SNK906304R0000	50	2.90
		5 poles	JB6-5	1SNK906305R0000	50	3.60
		10 poles	JB6-10	1SNK906310R0000	20	7.40
3 Test connectors	Dark grey	TC5-R1	1SNK900201R0000	10	5.20	
4 Spacers	Dark grey	ES-TC6	1SNK900105R0000	10	0.80	
5 Terminal block markers	White	Blank marker	MG-CPM 13 41791	1SNB041791R0612	1680	0.27
		Blank card	MC612	1SNK150000R0000	22	10.00
			MC612PA	1SNK159999R0000	20	11.00
	Universal wire markers holder	Grey	UMH	1SNK900611R0000	10	0.20

Complete list of accessories is indicated in the terminal block datasheet including end stops.

Some accessories such as jumper bars may modify the terminal block's ratings: Complete information available in the accessories section of the catalog.

Technical data valid for copper conductors only.

ZS4-SF-R screw clamp terminal blocks

For 5 x 20 fuses - with blown fuse indicator - 6 mm 0.236 in spacing

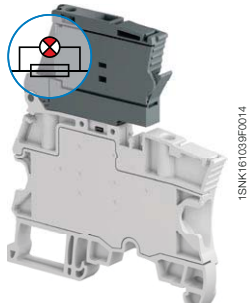

ZS4-SF-R

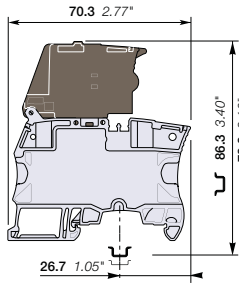

6 mm 0.236 in spacing

Description

- Protect your circuits with 5x20 fuse terminal blocks compliant with IEC 60947-7-3 standard (fuse not supplied with the terminal blocks),
- Simplify the distribution thanks to the two jumper channels aligned with ZS4 or ZS4-R2 feed-through and ZS4-S-R1 disconnect terminal blocks,
- Quickly identify the defective circuit thanks to the blown fuse indicator (with leakage current < 0.5 mA).

Ordering details

Description	Color	Type	Part Number	Pkg qty	Weight (1 pce) g
Fuse With blown fuse indicator 115 ... 250 V AC / DC	Grey, dark grey	ZS4-SF-R3	1SNK506415R0000	50	18.60
With blown fuse indicator 24 ... 110 V AC / DC		ZS4-SF-R1	1SNK506412R0000	50	18.60

Main technical data

Connecting capacity		IEC	UL - CSA	Mounting instructions	
1 conductor per clamp	Rigid: Solid/Stranded	0.2 ... 4 mm ²	24 ... 10 AWG	Rail	TH 35-7.5, TH 35-15
	Flexible without ferrule	0.22 ... 4 mm ²		Wire stripping length	10.5 mm 0.412 in
	Flexible with non insulated ferrule	0.22 ... 4 mm ²	24 ... 12 AWG	Tool	Flat screwdriver Ø 3.5 mm Ø 0.138 in
	Flexible with insulated ferrule	0.22 ... 4 mm ²	24 ... 12 AWG		
Gauge		A3-B3		Torque	0.6 Nm ± 0.1 5.31 lb.in ± 0.885
2 conductors per clamp	Rigid: Solid/Stranded	0.2 ... 1.5 mm ²	24 ... 16 AWG		
	Flexible without ferrule	0.2 ... 1.5 mm ²			
	Flexible with twin ferrule	0.22 ... 1.5 mm ²	24 ... 16 AWG		
Rated current / Rated cross section		6.3 A / 4 mm ²	10 A / 10 AWG		
Rated voltage		500 V	150 V		
Impulse withstand voltage		6000 V			
Protection		IP20	NEMA 1		

Mount your fuse safely without touching any active part: put the fuse into the hooks of the fuse holder shutter; at the closing of the shutter, the fuse is perfectly in place in the fuse holder.

Separate arrangement		Assembly composed of 1 fuse terminal block in between non fuse terminal blocks	Overload and short-circuit protection	2.5 W
			Exclusive short-circuit protection	4 W
Compound arrangement		Assembly composed of 5 fuse terminal blocks	Overload and short-circuit protection	2.5 W
			Exclusive short-circuit protection	4 W

The connecting capacity data for one Rigid: Solid/Stranded, or one Flexible conductor (when applicable) is a mandatory information required by IEC, UL and CSA standards (Copper conductors). All other data are provided as supplementary information only. For more details, please consult our CB, UL or CSA certificates and technical datasheet available on <http://www.TE.com>

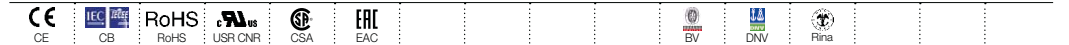

Accessories

Description	Color	Type	Part Number	Pkg qty	Weight (1 pce) g	
1 End stops	Dark grey	BAM4	1SNK900001R0000	50	14.00	
2 Jumper bars	Orange	2 poles	JB6-2	1SNK906302R0000	50	1.30
		3 poles	JB6-3	1SNK906303R0000	50	2.10
		4 poles	JB6-4	1SNK906304R0000	50	2.90
		5 poles	JB6-5	1SNK906305R0000	50	3.60
		10 poles	JB6-10	1SNK906310R0000	20	7.40
3 Test adapters	Dark grey	For test plugs DIA 2 mm 0.079 in	TP2	1SNK900203R0000	20	1.70
		For test plugs DIA 4 mm 0.157 in	TP4	1SNK900205R0000	20	2.40
4 Test connectors	Dark grey	TC5-R1	1SNK900201R0000	10	5.20	
5 Spacers	Dark grey	ES-TC6	1SNK900105R0000	10	0.80	
6 Terminal block markers	White	Blank marker	MG-CPM 13 41791	1SNB041791R0612	1680	0.27
		Blank card	MC612	1SNK150000R0000	22	10.00
			MC612PA	1SNK159999R0000	20	11.00
	Universal wire markers holder	Grey	UMH	1SNK900611R0000	10	0.20

Complete list of accessories is indicated in the terminal block datasheet including end stops. Some accessories such as jumper bars may modify the terminal block's ratings: Complete information available in the accessories section of the catalog.

Technical data valid for copper conductors only.

ZS4-SF-R screw clamp terminal blocks

For 5 x 20 fuses - with blown fuse indicator and test sockets - 6 mm 0.236 in spacing

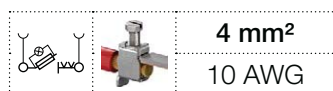

4 mm²
10 AWG

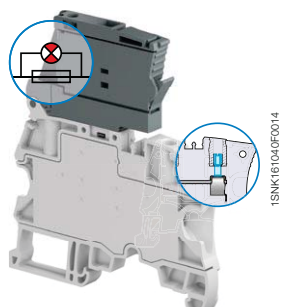

ZS4-SF-R

Description

- Protect your circuits with 5x20 fuse terminal blocks compliant with IEC 60947-7-3 standard (fuse not supplied with the terminal blocks),
- Simplify the distribution thanks to the two jumper channels aligned with ZS4 or ZS4-R2 feed-through and ZS4-S-R1 disconnect terminal blocks,
- Ease the test with built-in test socket screws,
- Quickly identify the defective circuit thanks to the blown fuse indicator (with leakage current < 0.5 mA).

Ordering details

Description	Color	Type	Part Number	Pkg qty	Weight (1 pce) g
Fuse With blown fuse indicator 115 ... 250 V AC / DC and 2 test sockets DIA 2 mm 0.079 in	Grey, dark grey	ZS4-SF-R4	1SNK506416R0000	50	18.60
With blown fuse indicator 24 ... 110 V AC / DC and 2 test sockets DIA 2 mm 0.079 in		ZS4-SF-R2	1SNK506413R0000	50	18.60

Main technical data

Connecting capacity	IEC	UL - CSA	Rail	Wire stripping length	TH 35-7.5, TH 35-15
1 conductor per clamp	Rigid: Solid/Stranded	0.2 ... 4 mm ²	24 ... 10 AWG		
	Flexible without ferrule	0.22 ... 4 mm ²			
	Flexible with non insulated ferrule	0.22 ... 4 mm ²	24 ... 12 AWG		
	Flexible with insulated ferrule	0.22 ... 4 mm ²	24 ... 12 AWG		
Gauge	A3-B3				
2 conductors per clamp	Rigid: Solid/Stranded	0.2 ... 1.5 mm ²	24 ... 16 AWG	Tool	Flat screwdriver Ø 3.5 mm Ø 0.138 in
	Flexible without ferrule	0.2 ... 1.5 mm ²			
	Flexible with twin ferrule	0.22 ... 1.5 mm ²	24 ... 16 AWG		
Rated current / Rated cross section	6.3 A / 4 mm ²	10 A / 10 AWG			
			Torque		0.6 Nm ± 0.1 5.31 lb.in ± 0.885
Rated voltage	500 V	150 V			
Impulse withstand voltage	6000 V				
Protection	IP20	NEMA 1			

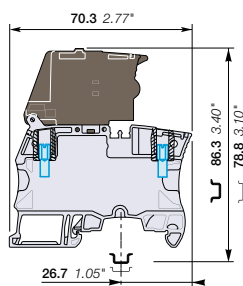

6 mm 0.236 in spacing

Mounting instructions

Mount your fuse safely without touching any active part: put the fuse into the hooks of the fuse holder shutter; at the closing of the shutter, the fuse is perfectly in place in the fuse holder.

Separate arrangement	Assembly composed of 1 fuse terminal block in between non fuse terminal blocks	Overload and short-circuit protection	2.5 W
		Exclusive short-circuit protection	4 W
Compound arrangement	Assembly composed of 5 fuse terminal blocks	Overload and short-circuit protection	2.5 W
		Exclusive short-circuit protection	4 W

The connecting capacity data for one Rigid: Solid/Stranded, or one Flexible conductor (when applicable) is a mandatory information required by IEC, UL and CSA standards (Copper conductors). All other data are provided as supplementary information only. For more details, please consult our CB, UL or CSA certificates and technical datasheet available on <http://www.TE.com>



Accessories

Description	Color	Type	Part Number	Pkg qty	Weight (1 pce) g	
1 End stops	Dark grey	BAM4	1SNK900001R0000	50	14.00	
2 Jumper bars	Orange	2 poles	JB6-2	1SNK906302R0000	50	1.30
		3 poles	JB6-3	1SNK906303R0000	50	2.10
		4 poles	JB6-4	1SNK906304R0000	50	2.90
		5 poles	JB6-5	1SNK906305R0000	50	3.60
		10 poles	JB6-10	1SNK906310R0000	20	7.40
		3 Test connectors	Dark grey	TC5-R1	1SNK900201R0000	10
4 Spacers	Dark grey	ES-TC6	1SNK900105R0000	10	0.80	
5 Terminal block markers	White	Blank marker	MG-CPM 13 41791	1SNB041791R0612	1680	0.27
		Blank card	MC612	1SNK150000R0000	22	10.00
			MC612PA	1SNK159999R0000	20	11.00
Universal wire markers holder	Grey	UMH	1SNK900611R0000	10	0.20	

Complete list of accessories is indicated in the terminal block datasheet including end stops. Some accessories such as jumper bars may modify the terminal block's ratings: Complete information available in the accessories section of the catalog.

Technical data valid for copper conductors only.

ZS4-R2 screw clamp terminal blocks

Feed-through - 6 mm 0.236 in spacing

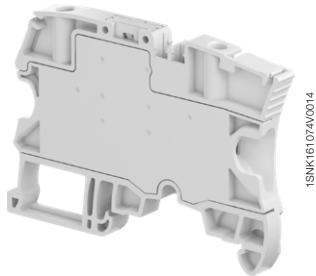

ZS4-R2

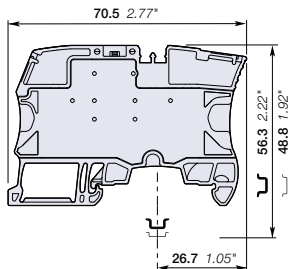

6 mm 0.236 in spacing

Description

- Simplify the distribution of circuits in marshalling cabinets thanks to our feed-through terminal blocks with the same profile as ZS4-SF fuse, ZS4-S-R1 disconnect and ZS4-PE-R2 ground terminal blocks: aligned conductor entries, jumper channels and marking in just 6 mm 0.236 in spacing,
- No end section needed: closed block.

Ordering details

Description	Color	Type	Part Number	Pkg qty	Weight (1 pce) g
Feed-through Profile aligned with ZS4-SF and ZS4-S-R1	Grey <input type="checkbox"/>	ZS4-R2	1SNK506013R0000	50	12.40

Main technical data

Connecting capacity		IEC	UL - CSA	Mounting instructions	
1 conductor per clamp	Rigid: Solid/Stranded	0.2 ... 4 mm ²	24 ... 10 AWG	Rail	TH 35-7.5, TH 35-15
	Flexible without ferrule	0.22 ... 4 mm ²		Wire stripping length	10.5 mm 0.413 in
	Flexible with non insulated ferrule	0.22 ... 4 mm ²	24 ... 12 AWG	Tool	Flat screwdriver Ø 3.5 mm Ø 0.138 in
	Flexible with insulated ferrule	0.22 ... 4 mm ²	24 ... 12 AWG		
Gauge		A3-B3		Torque	0.6 Nm ± 0.1 5.31 lb.in ± 0.885
2 conductors per clamp	Rigid: Solid/Stranded	0.2 ... 1.5 mm ²	24 ... 16 AWG		
	Flexible without ferrule	0.2 ... 1.5 mm ²	24 ... 16 AWG		
	Flexible with twin ferrule	0.22 ... 1.5 mm ²	24 ... 16 AWG		
Rated current / Rated cross section		32 A / 4 mm ²	30 A / 10 AWG		
Rated short-time withstand current (1s)		480 A			
Rated voltage		800 V	300 V		
Impulse withstand voltage		8000 V			
Protection		IP20	NEMA 1		

The connecting capacity data for one Rigid: Solid/Stranded, or one Flexible conductor (when applicable) is a mandatory information required by IEC, UL and CSA standards (Copper conductors). All other data are provided as supplementary information only. For more details, please consult our CB, UL or CSA certificates and technical datasheet available on <http://www.TE.com>



Accessories

Description	Color	Type	Part Number	Pkg qty	Weight (1 pce) g
1 End stops 10 mm 0.394 in	Dark grey <input type="checkbox"/>	BAM4	1SNK900001R0000	50	14.00
2 Jumper bars 2 poles 41 A (IEC)	Orange <input type="checkbox"/>	JB6-2	1SNK906302R0000	50	1.30
		JB6-3	1SNK906303R0000	50	2.10
		JB6-4	1SNK906304R0000	50	2.90
		JB6-5	1SNK906305R0000	50	3.60
		JB6-10	1SNK906310R0000	20	7.40
3 Cross spacing jumpers 3 poles 32 A (IEC)	Orange <input type="checkbox"/>	JB85-3	1SNK900603R0000	10	2.80
4 Test adapters For test plugs DIA 2 mm 0.079 in	Dark grey <input type="checkbox"/>	TP2	1SNK900203R0000	20	1.70
		TP4	1SNK900205R0000	20	2.40
5 Test connectors End module, 5.2 mm 0.205 in	Dark grey <input type="checkbox"/>	TC5-R1	1SNK900201R0000	10	5.20
6 Spacers 0.8 mm 0.031 in	Dark grey <input type="checkbox"/>	ES-TC6	1SNK900105R0000	10	0.80
7 Terminal block markers Blank marker	White <input type="checkbox"/>	MG-CPM 13 41791	1SNB041791R0612	1680	0.27
		MC612	1SNK150000R0000	22	10.00
		MC612PA	1SNK159999R0000	20	11.00
Universal wire markers holder	Grey <input type="checkbox"/>	UMH	1SNK900611R0000	10	0.20

Complete list of accessories is indicated in the terminal block datasheet including end stops. Some accessories such as jumper bars may modify the terminal block's ratings: Complete information available in the accessories section of the catalog.

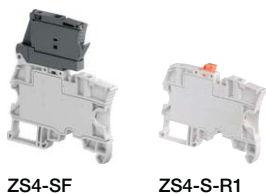
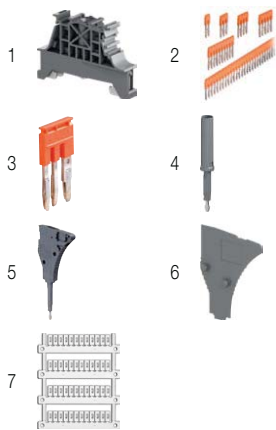

ZS4-SF

ZS4-S-R1

Screw clamp terminal blocks

Description	Color	Type	Part Number	Pkg qty	Weight (1 pce) g
Fuse Profile aligned with ZS4-R2 and ZS4-PE-R2	Grey, dark grey <input type="checkbox"/>	ZS4-SF	1SNK506410R0000	50	18.60
Disconnect Profile aligned with ZS4-R2 and ZS4-PE-R2	Grey <input type="checkbox"/>	ZS4-S-R1	1SNK506310R0000	50	13.20

Technical data valid for copper conductors only.

ZS4-PE-R2 screw clamp terminal blocks

Ground - 6 mm 0.236 in spacing



ZS4-PE-R2

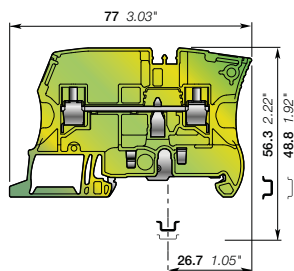

6 mm 0.236 in spacing

Description

Simplify the shielding connection of your analog circuits in marshalling cabinets thanks to our ground terminal blocks with the same profile as ZS4-SF fuse, ZS4-S-R1 disconnect and ZS4-R2 feed-through terminal blocks.

Ordering details

Description	Color	Type	Part Number	Pkg qty	Weight (1 pce) g
Ground Screwless rail connection	Green-yellow	ZS4-PE-R2	1SNK506153R0000	25	15.30

Main technical data

Connecting capacity		IEC	UL - CSA	Mounting instructions	
1 conductor per clamp	Rigid: Solid/Stranded	0.2 ... 4 mm²	24 ... 10 AWG	Rail	TH 35-7.5, TH 35-15
	Flexible without ferrule	0.22 ... 4 mm²	24 ... 12 AWG	Wire stripping length	10.5 mm 0.413 in
	Flexible with non insulated ferrule	0.22 ... 4 mm²	24 ... 12 AWG		
	Flexible with insulated ferrule	0.22 ... 4 mm²	24 ... 12 AWG		
	Gauge	A3-B3		Tool	Flat screwdriver Ø 3.5 mm Ø 0.138 in
Rated cross section		4 mm²	10 AWG	Torque	0.6 Nm ± 0.1 5.31 lb.in ± 0.885
Rated short-time withstand current (1s)		480 A	396 A		
Protection		IP20	NEMA 1		

The connecting capacity data for one Rigid: Solid/Stranded, or one Flexible conductor (when applicable) is a mandatory information required by IEC, UL and CSA standards (Copper conductors). All other data are provided as supplementary information only. For more details, please consult our CB, UL or CSA certificates and technical datasheet available on <http://www.TE.com>

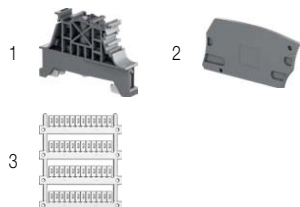

Accessories

Description	Color	Type	Part Number	Pkg qty	Weight (1 pce) g
1 End stops	Dark grey	BAM4	1SNK900001R0000	50	14.00
2 End sections	Dark grey	ES6-4S	1SNK505911R0000	20	3.10
3 Terminal block markers	White	MG-CPM 13 41791	1SNB041791R0612	1680	0.27
		MC612	1SNK150000R0000	22	10.00
		MC612PA	1SNK159999R0000	20	11.00
Universal wire markers holder	Grey	UMH	1SNK900611R0000	10	0.20

Complete list of accessories is indicated in the terminal block datasheet including end stops. Some accessories such as jumper bars may modify the terminal block's ratings: Complete information available in the accessories section of the catalog.



ZS4-SF

ZS4-S-R1

Screw clamp terminal blocks

Description	Color	Type	Part Number	Pkg qty	Weight (1 pce) g
Fuse	Grey, dark grey	ZS4-SF	1SNK506410R0000	50	18.60
Disconnect	Grey	ZS4-S-R1	1SNK506310R0000	50	13.20

Technical data valid for copper conductors only.

ZS4-S-R2 screw clamp terminal blocks

Disconnect with lever - 6 mm 0.236 in spacing

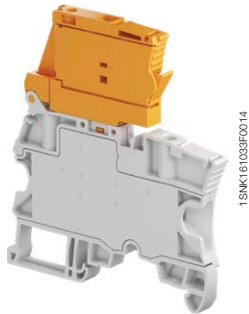
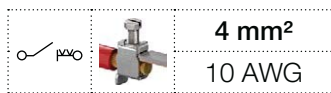

ZS4-S-R2

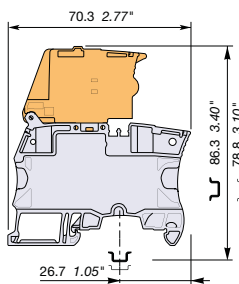

6 mm 0.236 in spacing

Description

Simplify the disconnect operations for the disconnect terminal blocks installed next to fuse terminal blocks ZS4-SF:
 - With the same profile as ZS4-SF, the ZS4-S-R2 disconnect lever is easily operated by hand and the wiring of the alternated disconnect and fuse circuits is easier.

Ordering details

Description	Color	Type	Part Number	Pkg qty	Weight (1 pce) g
Disconnect Profile aligned with ZS4-SF	Grey, orange	ZS4-S-R2	1SNK506414R0000	50	21.6

Main technical data

Connecting capacity		IEC	UL - CSA	Mounting instructions	
1 conductor per clamp	Rigid: Solid/Stranded	0.2 ... 4 mm ²	24 ... 10 AWG	Rail	 TH 35-7.5, TH 35-15 10.5 mm 0.412 in
	Flexible without ferrule	0.22 ... 4 mm ²			
	Flexible with non insulated ferrule	0.22 ... 4 mm ²	24 ... 12 AWG	Wire stripping length	 10.5 mm 0.412 in
	Flexible with insulated ferrule	0.22 ... 4 mm ²	24 ... 12 AWG		
Gauge		A3-B3		Tool	 Flat screwdriver Ø 3.5 mm Ø 0.138 in
2 conductors per clamp	Rigid: Solid/Stranded	0.2 ... 1.5 mm ²	24 ... 16 AWG		
	Flexible without ferrule	0.2 ... 1.5 mm ²			
	Flexible with twin ferrule	0.22 ... 1.5 mm ²	24 ... 16 AWG		
Rated current / Rated cross section		18 A / 2.5 mm ²	13 A / 10 AWG	Torque	 0.6 Nm ± 0.1 5.31 lb.in ± 0.885
Maximum current / Maximum cross section		18 A / 4 mm ²			
Rated short-time withstand current (1s)		300 A			
Rated voltage		400 V	150 V		
Impulse withstand voltage		6000 V			
Protection		IP20	NEMA 1		

Recommendation for best usage: in horizontal assemblies, disconnect terminal blocks should be mounted with fixed foot on top (power side) so that the disconnect lever does not partially close through gravity. Furthermore, as specified per IEC 60947-7-1, disconnect terminal blocks are intended to be used for temporary disconnection at zero potential and at no load.

The connecting capacity data for one Rigid: Solid/Stranded, or one Flexible conductor (when applicable) is a mandatory information required by IEC, UL and CSA standards (Copper conductors). All other data are provided as supplementary information only. For more details, please consult our CB, UL or CSA certificates and technical datasheet available on <http://www.TE.com>

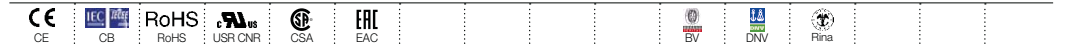

Accessories

Description	Color	Type	Part Number	Pkg qty	Weight (1 pce) g	
1 End stops	Dark grey	BAM4	1SNK900001R0000	50	14.00	
2 Jumper bars	Orange	2 poles	JB6-2	1SNK906302R0000	50	1.30
		3 poles	JB6-3	1SNK906303R0000	50	2.10
		4 poles	JB6-4	1SNK906304R0000	50	2.90
		5 poles	JB6-5	1SNK906305R0000	50	3.60
		10 poles	JB6-10	1SNK906310R0000	20	7.40
3 Test adapters	Dark grey	For test plugs DIA 2 mm 0.079 in	TP2	1SNK900203R0000	20	1.70
		For test plugs DIA 4 mm 0.157 in	TP4	1SNK900205R0000	20	2.40
4 Test connectors	Dark grey	TC5-R1	1SNK900201R0000	10	5.20	
5 Spacers	Dark grey	ES-TC6	1SNK900105R0000	10	0.80	
6 Terminal block markers	White	Blank marker	MG-CPM 13 41791	1SNB041791R0612	1680	0.27
		Blank card	MC612	1SNK150000R0000	22	10.00
		Universal wire markers holder	MC612PA	1SNK159999R0000	20	11.00
	Grey	UMH	1SNK900611R0000	10	0.20	

Complete list of accessories is indicated in the terminal block datasheet including end stops. Some accessories such as jumper bars may modify the terminal block's ratings: Complete information available in the accessories section of the catalog.

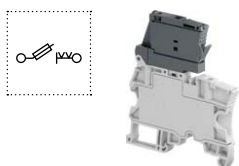
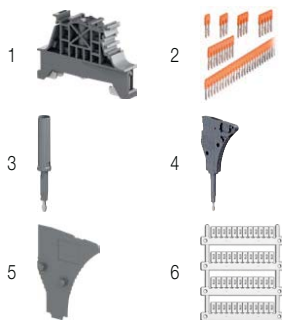

Fuse screw clamp terminal blocks

Description	Color	Type	Part Number	Pkg qty	Weight (1 pce) g
Fuse	Grey, dark grey	ZS4-SF	1SNK506410R0000	50	18.60

Technical data valid for copper conductors only.

ZS10-SF screw clamp terminal blocks

For 6.3x32 fuses - 8 mm 0.315 in spacing



ZS10-SF

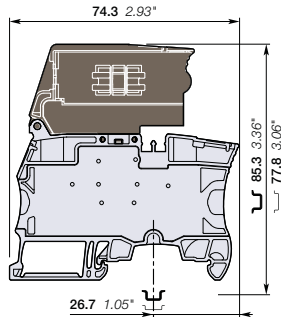

8 mm 0.315 in spacing

Description

- Protect your circuits with 6.3x32 (¼ x 1¼ in) fuse terminal blocks compliant with IEC 60947-7-3 standard (fuse not supplied with the terminal blocks),
- Simplify the distribution thanks to the two jumper channels.

Ordering details

Description	Color	Type	Part Number	Pkg qty	Weight (1 pce) g
Fuse Closed block	Grey, dark grey	ZS10-SF	1SNK508418R0000	50	28.50

Main technical data

Connecting capacity		IEC	UL - CSA	Mounting instructions	
1 conductor per clamp	Rigid: Solid/Stranded	0.5 ... 10 mm ²	24 ... 6 AWG	Rail	TH 35-7.5, TH 35-15
	Flexible without ferrule	0.5 ... 10 mm ²		Wire stripping length	13 mm 0.512 in
	Flexible with non insulated ferrule	0.5 ... 10 mm ²	24 ... 8 AWG		
	Flexible with insulated ferrule	0.5 ... 6 mm ²	24 ... 10 AWG		
Gauge		A5-B5		Tool	Flat screwdriver Ø 4 mm Ø 0.157 in
2 conductors per clamp	Rigid: Solid/Stranded	0.5 ... 4 mm ²	20 ... 12 AWG		
	Flexible without ferrule	0.5 ... 4 mm ²	20 ... 12 AWG		
Flexible with twin ferrule		0.5 ... 4 mm ²	20 ... 12 AWG	Torque	1.3 Nm ± 0.3 11.5 lb.in ± 2.65
Rated current / Rated cross section		10 A / 10 mm ²	22 A / 6 AWG		
Rated voltage		630 V	600 V		
Impulse withstand voltage		6000 V			
Protection		IP20	NEMA 1		

Mount your fuse safely without touching any active part: put the fuse into the hooks of the fuse holder shutter; at the closing of the shutter, the fuse is perfectly in place in the fuse holder.

Separate arrangement		Assembly composed of 1 fuse terminal block in between non fuse terminal blocks	Overload and short-circuit protection	4 W
			Exclusive short-circuit protection	4 W
Compound arrangement		Assembly composed of 5 fuse terminal blocks	Overload and short-circuit protection	2.5 W
			Exclusive short-circuit protection	2.5 W

The connecting capacity data for one Rigid: Solid/Stranded, or one Flexible conductor (when applicable) is a mandatory information required by IEC, UL and CSA standards (Copper conductors). All other data are provided as supplementary information only. For more details, please consult our CB, UL or CSA certificates and technical datasheet available on <http://www.TE.com>

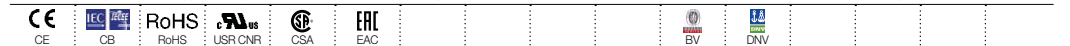

Accessories

Description	Color	Type	Part Number	Pkg qty	Weight (1 pce) g	
1 End stops	Dark grey	BAM4	1SNK900001R0000	50	14.00	
2 Jumper bars	Orange	2 poles	JB8-2	1SNK908302R0000	50	2.70
		3 poles	JB8-3	1SNK908303R0000	50	4.10
		4 poles	JB8-4	1SNK908304R0000	50	5.60
		5 poles	JB8-5	1SNK908305R0000	40	7.00
		10 poles	JB8-10	1SNK908310R0000	20	14.20
3 Test adapters	Dark grey	For test plugs DIA 2 mm 0.079 in	TP2	1SNK900203R0000	20	1.70
		For test plugs DIA 4 mm 0.157 in	TP4	1SNK900205R0000	20	2.40
4 Test connectors	Dark grey	5.2 mm 0.205 in spacing	TC5	1SNK900200R0000	10	5.20
		End module, 5.2 mm 0.205 in	TC5-R1	1SNK900201R0000	10	5.20
5 Spacers	Dark grey	2.8 mm	ES-TC8	1SNK900104R0000	10	1.40
		0.110 in				
6 Terminal block markers	White	Blank marker	MG-CPM 13 41791	1SNB041791R0612	1680	0.27
		Blank card	MC812	1SNK160000R0000	22	10.00
			MC812PA	1SNK169999R0000	20	14.00
		Universal wire markers holder	UMH	1SNK900611R0000	10	0.20

Complete list of accessories is indicated in the terminal block datasheet including end stops. Some accessories such as jumper bars may modify the terminal block's ratings. Complete information available in the accessories section of the catalog.

Technical data valid for copper conductors only.

ZS10-SF-R screw clamp terminal blocks

For 6.3x32 fuses - with blown fuse indicator - 8 mm 0.315 in spacing

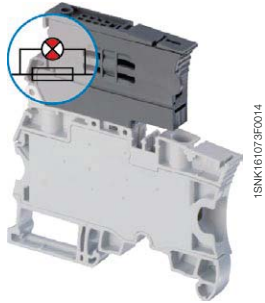

ZS10-SF-R

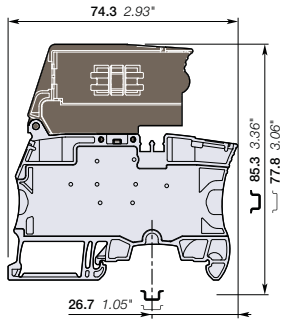

8 mm 0.315 in spacing

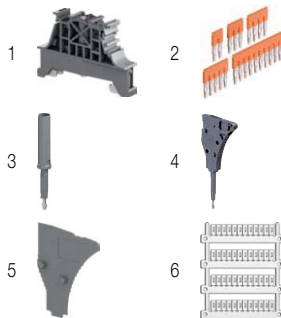

Description

- Protect your circuits with 6.3x32 (1/4 x 1 1/4 in) fuse terminal blocks compliant with IEC 60947-7-3 standard (fuse not supplied with the terminal blocks),
- Quickly identify the defective circuit thanks to the blown fuse indicator (with leakage current < 0.5 mA).

Ordering details

Description	Color	Type	Part Number	Pkg qty	Weight (1 pce) g
Fuse With blown fuse indicator 115 ... 250 V AC / DC	Grey, dark grey	ZS10-SF-R3	1SNK508422R0000	50	30.50
With blown fuse indicator 24 ... 110 V AC / DC		ZS10-SF-R1	1SNK508421R0000	50	30.50

Main technical data

Connecting capacity	IEC	UL - CSA	Mounting instructions
1 conductor per clamp	Rigid: Solid/Stranded Flexible without ferrule Flexible with non insulated ferrule Flexible with insulated ferrule Gauge	0.5 ... 10 mm ² 0.5 ... 10 mm ² 0.5 ... 10 mm ² 0.5 ... 6 mm ² A5-B5	24 ... 6 AWG 24 ... 8 AWG 24 ... 10 AWG
2 conductors per clamp	Rigid: Solid/Stranded Flexible without ferrule Flexible with twin ferrule	0.5 ... 4 mm ² 0.5 ... 4 mm ² 0.5 ... 4 mm ²	20 ... 12 AWG 20 ... 12 AWG
Rated current / Rated cross section		10 A / 10 mm ²	22 A / 6 AWG
Rated voltage		630 V	600 V
Impulse withstand voltage		6000 V	
Protection		IP20	NEMA 1
Wire stripping length			13 mm 0.512 in
Tool			Flat screwdriver Ø 4 mm Ø 0.157 in
Torque			1.3 Nm ± 0.3 11.5 lb.in ± 2.65

Mount your fuse safely without touching any active part: put the fuse into the hooks of the fuse holder shutter; at the closing of the shutter, the fuse is perfectly in place in the fuse holder.

Separate arrangement		Assembly composed of 1 fuse terminal block in between non fuse terminal blocks	Overload and short-circuit protection	4 W
			Exclusive short-circuit protection	4 W
Compound arrangement		Assembly composed of 5 fuse terminal blocks	Overload and short-circuit protection	2.5 W
			Exclusive short-circuit protection	2.5 W

The connecting capacity data for one Rigid: Solid/Stranded, or one Flexible conductor (when applicable) is a mandatory information required by IEC, UL and CSA standards (Copper conductors). All other data are provided as supplementary information only. For more details, please consult our CB, UL or CSA certificates and technical datasheet available on <http://www.TE.com>

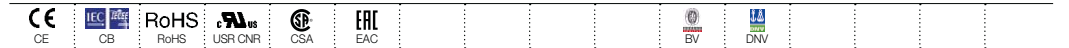

Accessories

Description	Color	Type	Part Number	Pkg qty	Weight (1 pce) g	
1 End stops	Dark grey	BAM4	1SNK900001R0000	50	14.00	
2 Jumper bars	Orange	JB8-2	1SNK908302R0000	50	2.70	
		JB8-3	1SNK908303R0000	50	4.10	
		JB8-4	1SNK908304R0000	50	5.60	
		JB8-5	1SNK908305R0000	40	7.00	
		JB8-10	1SNK908310R0000	20	14.20	
		3 Test adapters	Dark grey	For test plugs DIA 2 mm 0.079 in	TP2	1SNK900203R0000
For test plugs DIA 4 mm 0.157 in	TP4	1SNK900205R0000		20	2.40	
4 Test connectors	Dark grey	5.2 mm 0.205 in spacing	TC5	1SNK900200R0000	10	5.20
		End module, 5.2 mm 0.205 in	TC5-R1	1SNK900201R0000	10	5.20
5 Spacers	Dark grey	ES-TC8	1SNK900104R0000	10	1.40	
6 Terminal block markers	White	Blank marker	MG-CPM 13 41791	1SNB041791R0612	1680	0.27
		Blank card	MC812	1SNK160000R0000	22	10.00
			MC812PA	1SNK169999R0000	20	14.00
		Universal wire markers holder	Grey	UMH	1SNK900611R0000	10

Complete list of accessories is indicated in the terminal block datasheet including end stops. Some accessories such as jumper bars may modify the terminal block's ratings: Complete information available in the accessories section of the catalog.

Technical data valid for copper conductors only.

ZS10-S-R2 screw clamp terminal blocks

Disconnect with lever - 8 mm 0.315 in spacing

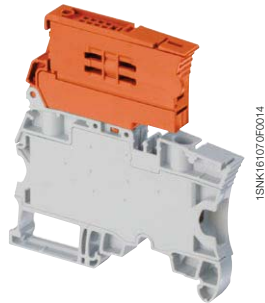

ZS10-S-R2

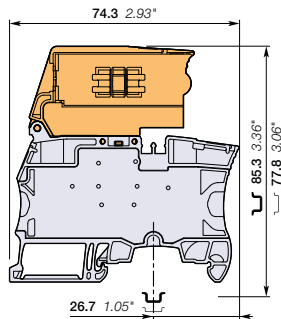

8 mm 0.315 in spacing

Description

Simplify the disconnect operations for the disconnect terminal blocks installed next to fuse terminal blocks ZS10-SF:
 – With the same profile as ZS10-SF, the ZS10-S-R2 disconnect lever is easily operated by hand and the wiring of the alternated disconnect and fuse circuits is easier.

Ordering details

Description	Color	Type	Part Number	Pkg qty	Weight (1 pce) g
Disconnect Profile aligned with ZS10-SF	Grey, orange	ZS10-S-R2	1SNK508417R0000	50	35.90

Main technical data

Connecting capacity	IEC	UL - CSA	Rail	Wire stripping length	Tool	Torque
1 conductor per clamp	Rigid: Solid/Stranded	0.5 ... 10 mm ²	24 ... 6 AWG	13 mm 0.512 in	Flat screwdriver Ø 4 mm Ø 0.157 in	1.3 Nm ± 0.3 11.5 lb.in ± 2.65
	Flexible without ferrule	0.5 ... 10 mm ²	24 ... 6 AWG			
	Flexible with non insulated ferrule	0.5 ... 10 mm ²	24 ... 8 AWG			
	Flexible with insulated ferrule	0.5 ... 10 mm ²	24 ... 10 AWG			
2 conductors per clamp	Rigid: Solid/Stranded	0.5 ... 4 mm ²	20 ... 12 AWG	Torque		
	Flexible without ferrule	0.5 ... 4 mm ²	20 ... 12 AWG			
	Flexible with twin ferrule	0.5 ... 4 mm ²	20 ... 12 AWG			
Rated current / Rated cross section		10 A / 4 mm ²	22 A / 25 AWG			
Maximum current / Maximum cross section		25 A / 10 mm ²				
Rated short-time withstand current (1s)		480 A				
Rated voltage		630 V	600 V			
Impulse withstand voltage		6000 V				
Protection		IP20	NEMA 1			

Recommendation for best usage: in horizontal assemblies, disconnect terminal blocks should be mounted with fixed foot on top (power side) so that the disconnect lever does not partially close through gravity. Furthermore, as specified per IEC 60947-7-1, disconnect terminal blocks are intended to be used for temporary disconnection at zero potential and at no load.

The connecting capacity data for one Rigid: Solid/Stranded, or one Flexible conductor (when applicable) is a mandatory information required by IEC, UL and CSA standards (Copper conductors). All other data are provided as supplementary information only. For more details, please consult our CB, UL or CSA certificates and technical datasheet available on <http://www.TE.com>

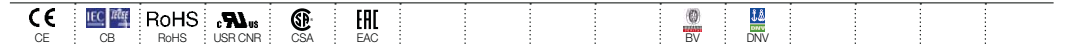

Accessories

Description	Color	Type	Part Number	Pkg qty	Weight (1 pce) g	
1 End stops	Dark grey	BAM4	1SNK900001R0000	50	14.00	
2 Jumper bars	Orange	2 poles	JB8-2	1SNK908302R0000	50	2.70
		3 poles	JB8-3	1SNK908303R0000	50	4.10
		4 poles	JB8-4	1SNK908304R0000	50	5.60
		5 poles	JB8-5	1SNK908305R0000	40	7.00
		10 poles	JB8-10	1SNK908310R0000	20	14.20
3 Test adapters	Dark grey	For test plugs DIA 2 mm 0.079 in	TP2	1SNK900203R0000	20	1.70
		For test plugs DIA 4 mm 0.157 in	TP4	1SNK900205R0000	20	2.40
4 Test connectors	Dark grey	5.2 mm 0.205 in spacing	TC5	1SNK900200R0000	10	5.20
		End module, 5.2 mm 0.205 in	TC5-R1	1SNK900201R0000	10	5.20
5 Spacers	Dark grey	ES-TC8	1SNK900104R0000	10	1.40	
6 Terminal block markers	White	Blank marker	MG-CPM 13 41791	1SNB041791R0612	1680	0.27
		Blank card	MC812	1SNK160000R0000	22	10.00
			MC812PA	1SNK169999R0000	20	14.00
		Universal wire markers holder	UMH	1SNK900611R0000	10	0.20

Complete list of accessories is indicated in the terminal block datasheet including end stops.

Some accessories such as jumper bars may modify the terminal block's ratings: Complete information available in the accessories section of the catalog.

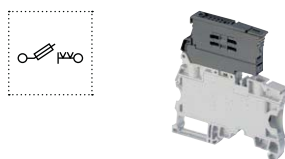
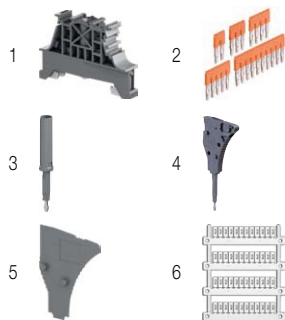

Fuse screw clamp terminal blocks

Description	Color	Type	Part Number	Pkg qty	Weight (1 pce) g
Fuse Closed block	Grey, dark grey	ZS10-SF	1SNK508418R0000	50	28.50

Technical data valid for copper conductors only.

ZS4-D2 screw clamp terminal blocks

Double deck with 2 feed-through circuits - 5.2 mm 0.205 in spacing



ZS4-D2

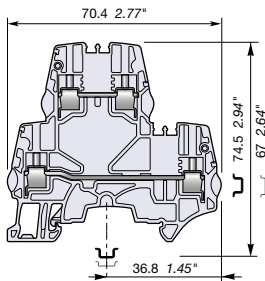

5.2 mm 0.205 in spacing

Description

- Save space with double deck terminal blocks: 2 independent circuits connected in just 5.2 mm 0.205 in spacing,
- Customize yourself the ZS4-D2 by soldering electronic components (up to 8.8 mm x 3.2 mm 0.346 x 0.125 in) in the existing linking bars punching.

Ordering details

Description	Color	Type	Part Number	Pkg qty	Weight (1 pce) g
Feed-through 2 feed-through circuits	Grey	ZS4-D2	1SNK505210R0000	50	15.30
	Blue	ZS4-D2-BL	1SNK505220R0000	50	15.30
	Orange	ZS4-D2-OR	1SNK505230R0000	50	15.30

Main technical data

Connecting capacity		IEC	UL - CSA	Mounting instructions	
1 conductor per clamp	Rigid: Solid/Stranded	0.2 ... 4 mm ²	24 ... 12 AWG	Rail	TH 35-7.5, TH 35-15
	Flexible without ferrule	0.22 ... 4 mm ²		Wire stripping length	10 mm 0.393 in
	Flexible with non insulated ferrule	0.22 ... 4 mm ²	24 ... 12 AWG		
	Flexible with insulated ferrule	0.22 ... 2.5 mm ²	24 ... 14 AWG	Tool	Flat screwdriver Ø 3.5 mm Ø 0.138 in
	Gauge	A3-B3			
2 conductors per clamp	Rigid: Solid/Stranded	0.2 ... 1.5 mm ²	24 ... 16 AWG	Torque	0.6 Nm ± 0.1 5.31 lb.in ± 0.885
	Flexible without ferrule	0.2 ... 1.5 mm ²			
	Flexible with twin ferrule	0.22 ... 1.5 mm ²	24 ... 16 AWG		
Rated current / Rated cross section		29 A / 4 mm ²	20 A / 12 AWG		
Rated short-time withstand current (1s)		480 A			
Short Circuit Current Rating (with specific conditions)			100 kA		
Rated voltage		800 V	300 V		
Impulse withstand voltage		8000 V			
Protection		IP20	NEMA 1		
Increased safety Ex e		440 V 29 A IEC/EN 60079-7 - IM2 II 2 GD Ex eb I/II/III C - 300 V 20 A UL 60079-7 - Class I, Zone 1, AEx e II, Ex e II U			

The connecting capacity data for one Rigid: Solid/Stranded, or one Flexible conductor (when applicable) is a mandatory information required by IEC, UL and CSA standards (Copper conductors). All other data are provided as supplementary information only. For more details, please consult our CB, UL or CSA certificates and technical datasheet available on <http://www.TE.com>



Accessories

Description	Color	Type	Part Number	Pkg qty	Weight (1 pce) g	
1 End stops 10 mm 0.394 in	Dark grey	BAZH1	1SNK900102R0000	20	24.00	
2 End sections 2.55 mm 0.100 in	Dark grey	ES4-D2	1SNK505960R0000	20	4.10	
3 Jumper bars 2 poles 32 A (IEC)	Orange	JB5-2	1SNK905302R0000	50	1.30	
		3 poles 32 A (IEC)	JB5-3	1SNK905303R0000	50	2.00
		4 poles 32 A (IEC)	JB5-4	1SNK905304R0000	50	2.70
		5 poles 32 A (IEC)	JB5-5	1SNK905305R0000	50	3.50
		10 poles 32 A (IEC)	JB5-10	1SNK905310R0000	30	7.10
4 Test adapters For test plugs DIA 2 mm 0.079 in	Dark grey	TP2	1SNK900203R0000	20	1.70	
		TP4	1SNK900205R0000	20	2.40	
5 Test connectors 5.2 mm 0.205 in spacing	Dark grey	TC5	1SNK900200R0000	10	5.20	
		TC5-R1	1SNK900201R0000	10	5.20	
6 Shield connectors		SHB	1SNK900602R0000	20	4.90	
7 Label holders	Dark grey	LH-J	1SNK900606R0000	100	0.73	
8 Terminal block markers	White	MG-CPM 13 41790	1SNB041790R0512	1960	0.23	
		MC512	1SNK140000R0000	22	9.00	
	Grey	MC512PA	1SNK149999R0000	20	10.00	
		Universal wire markers holder	UMH	1SNK900611R0000	10	0.20

Complete list of accessories is indicated in the terminal block datasheet including end stops. Some accessories such as jumper bars may modify the terminal block's ratings. Complete information available in the accessories section of the catalog.

Technical data valid for copper conductors only.

ZS4-D1 screw clamp terminal blocks

Double deck with 1 feed-through circuit - 5.2 mm 0.205 in spacing



Description

- Ease one potential distribution on 4 independent screw clamps,
- Save space by connecting conductors up to 4 mm² (CB certified) 12 AWG in just 5.2 mm 0.205 in spacing.

Ordering details

Description	Color	Type	Part Number	Pkg qty	Weight (1 pce) g
Feed-through 1 feed-through circuit	Grey <input type="checkbox"/>	ZS4-D1	1SNK505211R0000	50	15.30

Main technical data

Connecting capacity		IEC	UL - CSA	Mounting instructions	
1 conductor per clamp	Rigid: Solid/Stranded	0.2 ... 4 mm ²	24 ... 12 AWG	Rail	TH 35-7.5, TH 35-15
	Flexible without ferrule	0.22 ... 4 mm ²		Wire stripping length	10 mm 0.393 in
	Flexible with non insulated ferrule	0.22 ... 4 mm ²	24 ... 12 AWG		
	Flexible with insulated ferrule	0.22 ... 2.5 mm ²	24 ... 14 AWG		
Gauge		A3-B3		Tool	Flat screwdriver Ø 3.5 mm Ø 0.138 in
2 conductors per clamp	Rigid: Solid/Stranded	0.2 ... 1.5 mm ²	24 ... 16 AWG		
	Flexible without ferrule	0.2 ... 1.5 mm ²			
	Flexible with twin ferrule	0.22 ... 1.5 mm ²	24 ... 16 AWG		
Rated current / Rated cross section		29 A / 4 mm ²	20 A / 12 AWG	Torque	0.6 Nm ± 0.1 5.31 lb.in ± 0.885
Rated short-time withstand current (1s)		480 A			
Short Circuit Current Rating (with specific conditions)			100 kA		
Rated voltage		800 V	300 V		
Impulse withstand voltage		8000 V			
Protection		IP20	NEMA 1		

Increased safety Ex e 440 V 29 A IEC/EN 60079-7 - IM2 II 2 GD Ex eb III/IIIC - 300 V 20 A UL 60079-7 - Class I, Zone 1, AEx e II, Ex e II U

The connecting capacity data for one Rigid: Solid/Stranded, or one Flexible conductor (when applicable) is a mandatory information required by IEC, UL and CSA standards (Copper conductors). All other data are provided as supplementary information only. For more details, please consult our CB, UL or CSA certificates and technical datasheet available on <http://www.TE.com>



ZS4-D1

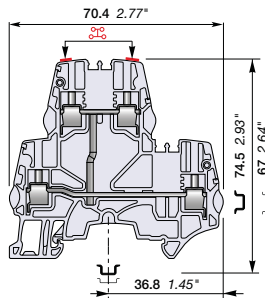

5.2 mm 0.205 in spacing

Accessories

Description	Color	Type	Part Number	Pkg qty	Weight (1 pce) g	
1 End stops	Dark grey <input checked="" type="checkbox"/>	BAZH1	1SNK900102R0000	20	24.00	
2 End sections	Dark grey <input checked="" type="checkbox"/>	ES4-D2	1SNK505960R0000	20	4.10	
3 Jumper bars	Orange <input checked="" type="checkbox"/>	2 poles	JB5-2	1SNK905302R0000	50	1.30
		3 poles	JB5-3	1SNK905303R0000	50	2.00
		4 poles	JB5-4	1SNK905304R0000	50	2.70
		5 poles	JB5-5	1SNK905305R0000	50	3.50
		10 poles	JB5-10	1SNK905310R0000	30	7.10
4 Test adapters	Dark grey <input checked="" type="checkbox"/>	For test plugs DIA 2 mm 0.079 in	TP2	1SNK900203R0000	20	1.70
		For test plugs DIA 4 mm 0.157 in	TP4	1SNK900205R0000	20	2.40
5 Test connectors	Dark grey <input checked="" type="checkbox"/>	5.2 mm 0.205 in spacing	TC5	1SNK900200R0000	10	5.20
		End module, 5.2 mm 0.205 in	TC5-R1	1SNK900201R0000	10	5.20
6 Shield connectors		SHB	1SNK900602R0000	20	4.90	
7 Label holders	Dark grey <input checked="" type="checkbox"/>	LH-J	1SNK900606R0000	100	0.73	
8 Terminal block markers	White <input type="checkbox"/>	Blank marker	MG-CPM 13 41790	1SNB041790R0512	1960	0.23
		Blank card	MC512	1SNK140000R0000	22	9.00
			MC512PA	1SNK149999R0000	20	10.00
		Universal wire markers holder	Grey <input type="checkbox"/>	UMH	1SNK900611R0000	10

Complete list of accessories is indicated in the terminal block datasheet including end stops.

Some accessories such as jumper bars may modify the terminal block's ratings: Complete information available in the accessories section of the catalog.

Technical data valid for copper conductors only.

ZS6-D2 screw clamp terminal blocks

Double deck with 2 feed-through circuits - 6 mm 0.236 in spacing



ZS6-D2

Description

- Save space with double deck terminal blocks: 2 independent circuits connected in just 6 mm 0.236 in spacing,
- Customize yourself the ZS6-D2 by soldering electronic components (up to 8.8 mm x 3.2 mm 0.346 x 0.125 in) in the existing linking bars punching,
- Boost the performances: ZS6-D... with ES4-D2 end section is rated 1000 V DC IEC, perfectly adapted to solar applications.

Ordering details

Description	Color	Type	Part Number	Pkg qty	Weight (1 pce) g
Feed-through 2 feed-through circuits	Grey	ZS6-D2	1SNK506210R0000	50	18.40
	Blue	ZS6-D2-BL	1SNK506220R0000	50	18.40
	Orange	ZS6-D2-OR	1SNK506230R0000	50	18.40
	Yellow	ZS6-D2-YL	1SNK506260R0000	50	18.40
	Red	ZS6-D2-RD	1SNK506262R0000	50	18.40
	White	ZS6-D2-WH	1SNK506265R0000	50	18.40
	Black	ZS6-D2-BK	1SNK506266R0000	50	18.40

Main technical data

Connecting capacity		IEC	UL - CSA	Rail			
1 conductor per clamp	Rigid: Solid/Stranded	0.2 ... 6 mm ²	24 ... 10 AWG	Wire stripping length		TH 35-7.5, TH 35-15	
	Flexible without ferrule	0.2 ... 6 mm ²	24 ... 10 AWG		Tool		10 mm 0.393 in
	Flexible with non insulated ferrule	0.22 ... 4 mm ²	24 ... 12 AWG	Torque			Flat screwdriver Ø 4 mm Ø 0.157 in
	Flexible with insulated ferrule	0.22 ... 4 mm ²	24 ... 12 AWG			Torque	
	Gauge	A4-B3					
2 conductors per clamp		Rigid: Solid/Stranded Flexible without ferrule Flexible with twin ferrule	0.2 ... 2.5 mm ² 0.2 ... 2.5 mm ² 0.22 ... 2.5 mm ²	24 ... 14 AWG 24 ... 14 AWG 24 ... 14 AWG			
Rated current / Rated cross section		40 A / 6 mm ²	30 A / 10 AWG				
Rated short-time withstand current (1s)		720 A					
Short Circuit Current Rating (with specific conditions)			100 kA				
Rated voltage		800 V	300 V				
Impulse withstand voltage		8000 V					
Protection		IP20	NEMA 1				

Increased safety Ex e 440 V 40 A IEC/EN 60079-7 - IM2 II 2 GD Ex eb I/II/IIIc - 300 V 30 A UL 60079-7 - Class I, Zone 1, AEx e II, Ex e II U

The connecting capacity data for one Rigid: Solid/Stranded, or one Flexible conductor (when applicable) is a mandatory information required by IEC, UL and CSA standards (Copper conductors). All other data are provided as supplementary information only. For more details, please consult our CB, UL or CSA certificates and technical datasheet available on <http://www.TE.com>

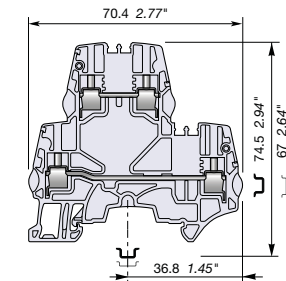

6 mm 0.236 in spacing

Accessories

Description	Color	Type	Part Number	Pkg qty	Weight (1 pce) g	
1 End stops	Dark grey	BAZH1	1SNK900102R0000	20	24.00	
2 End sections	Dark grey	ES4-D2	1SNK505960R0000	20	4.10	
3 Jumper bars	Orange	2 poles	JB6-2	1SNK906302R0000	50	1.30
		3 poles	JB6-3	1SNK906303R0000	50	2.10
		4 poles	JB6-4	1SNK906304R0000	50	2.90
		5 poles	JB6-5	1SNK906305R0000	50	3.60
		10 poles	JB6-10	1SNK906310R0000	20	7.40
4 Test adapters	Dark grey	For test plugs DIA 2 mm 0.079 in	TP2	1SNK900203R0000	20	1.70
		For test plugs DIA 4 mm 0.157 in	TP4	1SNK900205R0000	20	2.40
5 Test connectors	Dark grey	TC5-R1	1SNK900201R0000	10	5.20	
6 Spacers	Dark grey	ES-TC6	1SNK900105R0000	10	0.80	
7 Shield connectors		SHB	1SNK900602R0000	20	4.90	
8 Terminal block markers	White	Blank marker	MG-CPM 13 41791	1SNB041791R0612	1680	0.27
		Blank card	MC612	1SNK150000R0000	22	10.00
			MC612PA	1SNK159999R0000	20	11.00
	Universal wire markers holder	Grey	UMH	1SNK900611R0000	10	0.20

Complete list of accessories is indicated in the terminal block datasheet including end stops. Some accessories such as jumper bars may modify the terminal block's ratings: Complete information available in the accessories section of the catalog.

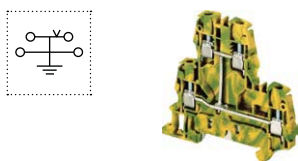
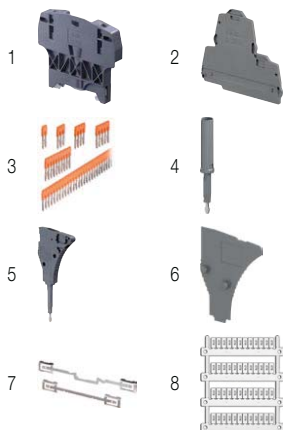

Ground screw clamp terminal blocks

Description	Color	Type	Part Number	Pkg qty	Weight (1 pce) g
Ground Profile aligned with ZS6-D2 and ZS6-D1	Green-yellow	ZS6-D1-PE	1SNK506250R0000	20	18.40

Technical data valid for copper conductors only.

ZS6-D1 screw clamp terminal blocks

Double deck with 1 feed-through circuit - 6 mm 0.236 in spacing

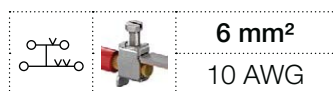

ZS6-D1

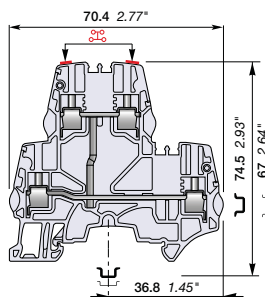

6 mm 0.236 in spacing

Description

- Ease one potential distribution on 4 independent screw clamps,
- Save space by connecting conductors up to 6 mm² 10 AWG in just 6 mm 0.236 in spacing,
- Boost the performances: ZS6-D... with ES4-D2 end section is rated 1000 V DC IEC, perfectly adapted to solar applications.

Ordering details

Description	Color	Type	Part Number	Pkg qty	Weight (1 pce) g
Feed-through 1 feed-through circuit	Grey <input type="checkbox"/>	ZS6-D1	1SNK506211R0000	50	18.40
	Red <input checked="" type="checkbox"/>	ZS6-D1-RD	1SNK506214R0000	50	18.40

Main technical data

Connecting capacity		IEC	UL - CSA	Mounting instructions	
1 conductor per clamp	Rigid: Solid/Stranded	0.2 ... 6 mm ²	24 ... 10 AWG	Rail	TH 35-7.5, TH 35-15
	Flexible without ferrule	0.2 ... 6 mm ²		Wire stripping length	10 mm 0.393 in
	Flexible with non insulated ferrule	0.22 ... 4 mm ²	24 ... 12 AWG	Tool	Flat screwdriver Ø 4 mm Ø 0.157 in
	Flexible with insulated ferrule	0.22 ... 4 mm ²	24 ... 12 AWG		
Gauge		A4-B3		Torque	0.85 Nm ± 0.15 7.52 lb.in ± 1.33
2 conductors per clamp	Rigid: Solid/Stranded	0.2 ... 2.5 mm ²	24 ... 14 AWG		
	Flexible without ferrule	0.2 ... 2.5 mm ²			
	Flexible with twin ferrule	0.22 ... 2.5 mm ²	24 ... 14 AWG		
Rated current / Rated cross section		40 A / 6 mm ²	30 A / 10 AWG		
Rated short-time withstand current (1s)		720 A			
Short Circuit Current Rating (with specific conditions)			100 kA		
Rated voltage		800 V	300 V		
Impulse withstand voltage		8000 V			
Protection		IP20	NEMA 1		

Increased safety Ex e 440 V 40 A IEC/EN 60079-7 - IM2 II 2 GD Ex eb I/IIIC - 300 V 30 A UL 60079-7 - Class I, Zone 1, AEx e II, Ex e II U

The connecting capacity data for one Rigid: Solid/Stranded, or one Flexible conductor (when applicable) is a mandatory information required by IEC, UL and CSA standards (Copper conductors). All other data are provided as supplementary information only. For more details, please consult our CB, UL or CSA certificates and technical datasheet available on <http://www.TE.com>



Accessories

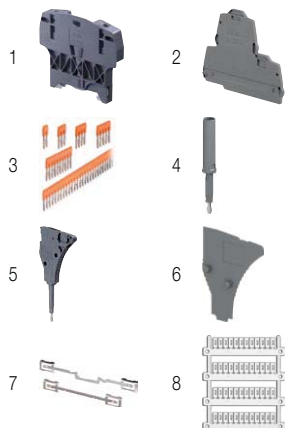

Description	Color	Type	Part Number	Pkg qty	Weight (1 pce) g
1 End stops 10 mm 0.394 in	Dark grey <input checked="" type="checkbox"/>	BAZH1	1SNK900102R0000	20	24.00
2 End sections 2.55 mm 0.100 in	Dark grey <input checked="" type="checkbox"/>	ES4-D2	1SNK505960R0000	20	4.10
3 Jumper bars 2 poles 41 A (IEC) 3 poles 41 A (IEC) 4 poles 41 A (IEC) 5 poles 41 A (IEC) 10 poles 41 A (IEC)	Orange <input checked="" type="checkbox"/>	JB6-2	1SNK906302R0000	50	1.30
		JB6-3	1SNK906303R0000	50	2.10
		JB6-4	1SNK906304R0000	50	2.90
		JB6-5	1SNK906305R0000	50	3.60
		JB6-10	1SNK906310R0000	20	7.40
4 Test adapters For test plugs DIA 2 mm 0.079 in For test plugs DIA 4 mm 0.157 in	Dark grey <input checked="" type="checkbox"/>	TP2	1SNK900203R0000	20	1.70
		TP4	1SNK900205R0000	20	2.40
5 Test connectors End module, 5.2 mm 0.205 in	Dark grey <input checked="" type="checkbox"/>	TC5-R1	1SNK900201R0000	10	5.20
6 Spacers 0.8 mm 0.031 in	Dark grey <input checked="" type="checkbox"/>	ES-TC6	1SNK900105R0000	10	0.80
7 Shield connectors		SHB	1SNK900602R0000	20	4.90
8 Terminal block markers Blank marker Blank card Universal wire markers holder	White <input type="checkbox"/>	MG-CPM 13 41791	1SNB041791R0612	1680	0.27
		MC612	1SNK150000R0000	22	10.00
		MC612PA	1SNK159999R0000	20	11.00
	Grey <input type="checkbox"/>	UMH	1SNK900611R0000	10	0.20

Complete list of accessories is indicated in the terminal block datasheet including end stops. Some accessories such as jumper bars may modify the terminal block's ratings: Complete information available in the accessories section of the catalog.

Technical data valid for copper conductors only.

ZS6-D2-PE screw clamp terminal blocks

Double deck with 1 feed-through circuit and 1 ground circuit - 6 mm 0.236 in spacing



ZS6-D2-PE

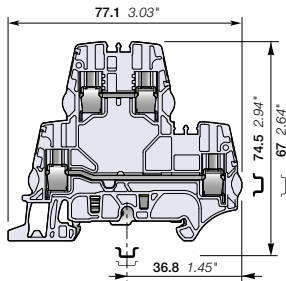

6 mm 0.236 in spacing

Description

- Save space with ZS6-D2-PE terminal blocks: 1 feed-through circuit and 1 ground circuit in just 6 mm 0.236 in spacing,
- Customize yourself the ZS6-D2-PE terminal blocks by soldering electronic components (up to 8.8 mm x 3.2 mm 0.346 x 0.125 in) in the existing linking bars punching.

Ordering details

Description	Color	Type	Part Number	Pkg qty	Weight (1 pce) g
Feed-through + ground	Grey <input type="checkbox"/>	ZS6-D2-PE	1SNK506212R0000	50	18.40

Main technical data

Connecting capacity		IEC	UL - CSA	Mounting instructions	
1 conductor per clamp	Rigid: Solid/Stranded	0.2 ... 6 mm ²	24 ... 10 AWG	Rail	TH 35-7.5, TH 35-15
	Flexible without ferrule	0.22 ... 6 mm ²		Wire stripping length	10 mm 0.393 in
	Flexible with non insulated ferrule	0.22 ... 4 mm ²	24 ... 12 AWG		
	Flexible with insulated ferrule	0.22 ... 4 mm ²	24 ... 12 AWG		
	Gauge	A4-B3			
2 conductors per clamp	Rigid: Solid/Stranded	0.2 ... 2.5 mm ²	24 ... 14 AWG	Tool	Flat screwdriver Ø 4 mm Ø 0.157 in
	Flexible without ferrule	0.2 ... 2.5 mm ²	24 ... 14 AWG		
	Flexible with twin ferrule	0.22 ... 2.5 mm ²	24 ... 14 AWG		
Rated current / Rated cross section		41 A / 6 mm ²	30 A / 10 AWG	Torque	0.85 Nm ± 0.15 7.52 lb.in ± 1.33
Rated short-time withstand current (1s)		720 A			
Short Circuit Current Rating (with specific conditions)					
Rated voltage		800 V	300 V		
Impulse withstand voltage		8000 V			
Protection		IP20	NEMA 1		

The connecting capacity data for one Rigid: Solid/Stranded, or one Flexible conductor (when applicable) is a mandatory information required by IEC, UL and CSA standards (Copper conductors). All other data are provided as supplementary information only. For more details, please consult our CB, UL or CSA certificates and technical datasheet available on <http://www.TE.com>

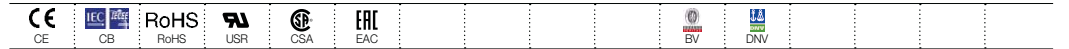

Accessories

Description	Color	Type	Part Number	Pkg qty	Weight (1 pce) g	
1 End stops	Dark grey <input checked="" type="checkbox"/>	BAZH1	1SNK900102R0000	20	24.00	
2 End sections	Dark grey <input checked="" type="checkbox"/>	ES4-D2	1SNK505960R0000	20	4.10	
3 Jumper bars	Orange <input checked="" type="checkbox"/>	2 poles	JB6-2	1SNK906302R0000	50	1.30
		3 poles	JB6-3	1SNK906303R0000	50	2.10
		4 poles	JB6-4	1SNK906304R0000	50	2.90
		5 poles	JB6-5	1SNK906305R0000	50	3.60
		10 poles	JB6-10	1SNK906310R0000	20	7.40
4 Test adapters	Dark grey <input checked="" type="checkbox"/>	TP4	1SNK900205R0000	20	2.40	
5 Test connectors	Dark grey <input checked="" type="checkbox"/>	TC5-R1	1SNK900201R0000	10	5.20	
6 Spacers	Dark grey <input checked="" type="checkbox"/>	ES-TC6	1SNK900105R0000	10	0.80	
7 Terminal block markers	White <input type="checkbox"/>	Blank marker	MG-CPM 13 41791	1SNB041791R0612	1680	0.27
		Blank card	MC612	1SNK150000R0000	22	10.00
			MC612PA	1SNK159999R0000	20	11.00
	Universal wire markers holder	Grey <input type="checkbox"/>	UMH	1SNK900611R0000	10	0.20

Complete list of accessories is indicated in the terminal block datasheet including end stops.

Some accessories such as jumper bars may modify the terminal block's ratings: Complete information available in the accessories section of the catalog.

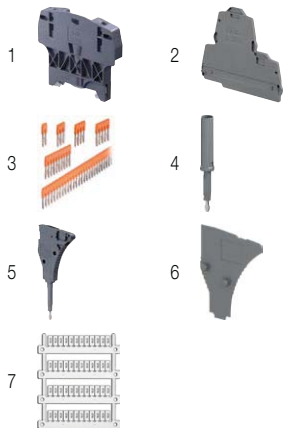

Feed-through screw clamp terminal blocks

Description	Color	Type	Part Number	Pkg qty	Weight (1 pce) g
Feed-through	Grey <input type="checkbox"/>	ZS6-D2	1SNK506210R0000	50	18.40



Technical data valid for copper conductors only.

ZS6-D1-PE screw clamp terminal blocks

Double deck with 1 ground circuit - 6 mm 0.236 in spacing

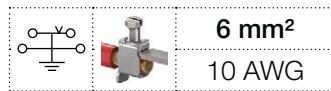

ZS6-D1-PE

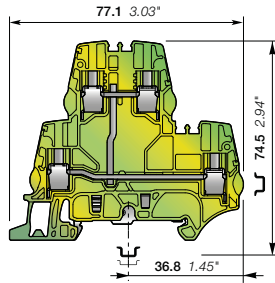

6 mm 0.236 in spacing

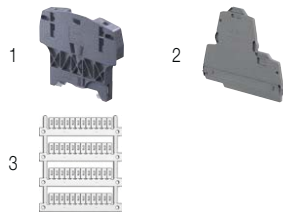

Description

- Save space with double deck ground terminal blocks aligned with ZS6-D2 double deck terminal blocks for convenient cabling process and circuit configuration,
- Benefit from our screwless rail connection: non operator independant, secured snap on or remove from the rail, performances above the requirements of IEC 60947-7-2 standard.

Ordering details

Description	Color	Type	Part Number	Pkg qty	Weight (1 pce) g
Ground 1 ground circuit	Green-yellow	ZS6-D1-PE	1SNK506250R0000	20	18.40

Main technical data

Connecting capacity		IEC	UL - CSA	Mounting instructions	
1 conductor per clamp	Rigid: Solid/Stranded	0.2 ... 6 mm ²	24 ... 10 AWG	Rail	TH 35-7.5, TH 35-15
	Flexible without ferrule	0.22 ... 6 mm ²		Wire stripping length	10 mm 0.393 in
	Flexible with non insulated ferrule	0.22 ... 4 mm ²	24 ... 12 AWG		
	Flexible with insulated ferrule	0.22 ... 4 mm ²	24 ... 12 AWG		
	Gauge	A4-B3		Tool	Flat screwdriver Ø 4 mm Ø 0.157 in
Rated cross section		6 mm ²	10 AWG	Torque	0.85 Nm ± 0.15 7.52 lb.in ± 1.33
Rated short-time withstand current (1s)		720 A			
Protection		IP20	NEMA 1		

The connecting capacity data for one Rigid: Solid/Stranded, or one Flexible conductor (when applicable) is a mandatory information required by IEC, UL and CSA standards (Copper conductors). All other data are provided as supplementary information only. For more details, please consult our CB, UL or CSA certificates and technical datasheet available on <http://www.TE.com>

CE	IEC	RoHS	UL	CSA	EAC	BV	DNV
CE	CB	RoHS	ULR	CSA	EAC	BV	DNV

Accessories

Description	Color	Type	Part Number	Pkg qty	Weight (1 pce) g
1 End stops	Dark grey	BAZH1	1SNK900102R0000	20	24.00
2 End sections	Dark grey	ES4-D2	1SNK505960R0000	20	4.10
3 Terminal block markers	White	MG-CPM 13 41791	1SNB041791R0612	1680	0.27
		MC612	1SNK150000R0000	22	10.00
		MC612PA	1SNK159999R0000	20	11.00
Universal wire markers holder	Grey	UMH	1SNK900611R0000	10	0.20

Complete list of accessories is indicated in the terminal block datasheet including end stops.

Some accessories such as jumper bars may modify the terminal block's ratings: Complete information available in the accessories section of the catalog.

Technical data valid for copper conductors only.

ZS4-D2-S screw clamp terminal blocks

Double deck with 1 disconnect circuit and 1 feed-through circuit - 5.2 mm 0.205 in spacing



1SNK161095V0014

ZS4-D2-S

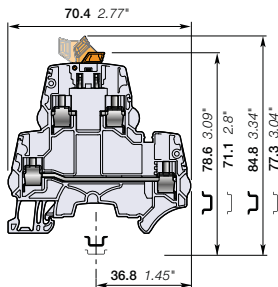

5.2 mm 0.205 in spacing

Description

- Save space: connect one complete circuit on a single block featuring disconnect and feed-through for the return circuit in just 5.2 mm 0.205 in spacing,
- Same profile as ZS4-D... double deck terminal blocks: convenient cabling process, aligned jumpers, markers and common end section.

Ordering details

Description	Color	Type	Part Number	Pkg qty	Weight (1 pce) g
Feed-through + disconnect	Grey <input type="checkbox"/>	ZS4-D2-S	1SNK505315R0000	50	15.90

Main technical data

Connecting capacity		IEC	UL - CSA	Mounting instructions	
1 conductor per clamp	Rigid: Solid/Stranded	0.2 ... 4 mm ²	24 ... 10 AWG	Rail	TH 35-7.5, TH 35-15
	Flexible without ferrule	0.22 ... 4 mm ²		Wire stripping length	10.5 mm 0.413 in
	Flexible with non insulated ferrule	0.22 ... 4 mm ²	24 ... 12 AWG		
	Flexible with insulated ferrule	0.22 ... 2.5 mm ²	24 ... 14 AWG		
	Gauge	A3-B3			
2 conductors per clamp	Rigid: Solid/Stranded	0.2 ... 1.5 mm ²	24 ... 16 AWG	Tool	Flat screwdriver Ø 3.5 mm Ø 0.138 in
	Flexible without ferrule	0.2 ... 1.5 mm ²			
	Flexible with twin ferrule	0.22 ... 1.5 mm ²	24 ... 16 AWG		
Disconnect circuit				Torque	0.6 Nm ± 0.1 5.31 lb.in ± 0.885
Rated current / Rated cross section		25 A / 4 mm ²	27 A / 10 AWG		
Feed-through circuit					
Rated current / Rated cross section		29 A / 4 mm ²	27 A / 10 AWG		
Rated short-time withstand current (1s)		480 A			
Rated voltage		630 V	300 V		
Impulse withstand voltage		8000 V			
Protection		IP20	NEMA 1		

Recommendation for best usage: in horizontal assemblies, disconnect terminal blocks should be mounted with fixed foot on top (power side) so that the disconnect knife does not partially close through gravity. Furthermore, as specified per IEC 60947-7-1, disconnect terminal blocks are intended to be used for temporary disconnection at zero potential and at no load.

The connecting capacity data for one Rigid: Solid/Stranded, or one Flexible conductor (when applicable) is a mandatory information required by IEC, UL and CSA standards (Copper conductors). All other data are provided as supplementary information only. For more details, please consult our CB, UL or CSA certificates and technical datasheet available on <http://www.TE.com>

--	--	--	--	--	--	--	--

Accessories

Description	Color	Type	Part Number	Pkg qty	Weight (1 pce) g	
1 End stops	Dark grey <input checked="" type="checkbox"/>	BAZH1	1SNK900102R0000	20	24.00	
2 End sections	Dark grey <input checked="" type="checkbox"/>	ES4-D2	1SNK505960R0000	20	4.10	
3 Jumper bars	Orange <input checked="" type="checkbox"/>	2 poles	JB5-2	1SNK905302R0000	50	1.30
		3 poles	JB5-3	1SNK905303R0000	50	2.00
		4 poles	JB5-4	1SNK905304R0000	50	2.70
		5 poles	JB5-5	1SNK905305R0000	50	3.50
		10 poles	JB5-10	1SNK905310R0000	30	7.10
		50 poles	JB5-50	1SNK905350R0000	10	36.00
4 Test adapters	Dark grey <input checked="" type="checkbox"/>	For test plugs DIA 2 mm 0.079 in	TP2	1SNK900203R0000	20	1.70
		For test plugs DIA 4 mm 0.157 in	TP4	1SNK900205R0000	20	2.40
5 Shield connectors		SHB	1SNK900602R0000	20	4.90	
6 Terminal block markers	White <input type="checkbox"/>	Blank marker	MG-CPM 13 41790	1SNB041790R0512	1960	0.23
		Blank card	MC512	1SNK140000R0000	22	9.00
			MC512PA	1SNK149999R0000	20	10.00
		Universal wire markers holder	Grey <input type="checkbox"/>	UMH	1SNK900611R0000	10

Complete list of accessories is indicated in the terminal block datasheet including end stops. Some accessories such as jumper bars may modify the terminal block's ratings: Complete information available in the accessories section of the catalog.

Technical data valid for copper conductors only.

ZS4-D2-S-T screw clamp terminal blocks

Double deck with 1 disconnect circuit with test socket screws and 1 feed-through circuit - 5.2 mm 0.205 in spacing



4 mm²
10 AWG

Description

Find the same functionalities as ZS4-D2-S, upgraded with the two built-in test socket screws meant to ease your signal testing during commissioning and maintenance.

Ordering details

Description	Color	Type	Part Number	Pkg qty	Weight (1 pce) g
Feed-through + disconnect	Grey <input type="checkbox"/>	ZS4-D2-S-T2	1SNK505316R0000	50	16.20

Main technical data

Connecting capacity		IEC	UL - CSA	Mounting instructions	
1 conductor per clamp	Rigid: Solid/Stranded	0.2 ... 4 mm ²	24 ... 10 AWG	Rail	TH 35-7.5, TH 35-15
	Flexible without ferrule	0.22 ... 4 mm ²	24 ... 12 AWG	Wire stripping length	10.5 mm 0.413 in
	Flexible with non insulated ferrule	0.22 ... 4 mm ²	24 ... 12 AWG	Tool	Flat screwdriver Ø 3.5 mm Ø 0.138 in
	Flexible with insulated ferrule	0.22 ... 2.5 mm ²	24 ... 14 AWG		
Gauge		A3-B3		Torque	0.6 Nm ± 0.1 5.31 lb.in ± 0.885
2 conductors per clamp	Rigid: Solid/Stranded	0.2 ... 1.5 mm ²	24 ... 16 AWG		
	Flexible without ferrule	0.2 ... 1.5 mm ²	24 ... 16 AWG		
	Flexible with twin ferrule	0.22 ... 1.5 mm ²	24 ... 16 AWG		
Disconnect circuit					
Rated current / Rated cross section		25 A / 4 mm ²	27 A / 10 AWG		
Feed-through circuit					
Rated current / Rated cross section		29 A / 4 mm ²	27 A / 10 AWG		
Rated short-time withstand current (1s)		480 A			
Rated voltage		630 V	300 V		
Impulse withstand voltage		8000 V			
Protection		IP20	NEMA 1		

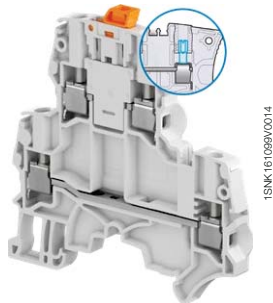

ZS4-D2-S-T

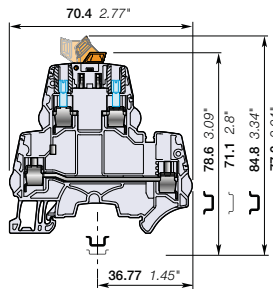

5.2 mm 0.205 in spacing

Recommendation for best usage: in horizontal assemblies, disconnect terminal blocks should be mounted with fixed foot on top (power side) so that the disconnect knife does not partially close through gravity. Furthermore, as specified per IEC 60947-7-1, disconnect terminal blocks are intended to be used for temporary disconnection at zero potential and at no load.

The connecting capacity data for one Rigid: Solid/Stranded, or one Flexible conductor (when applicable) is a mandatory information required by IEC, UL and CSA standards (Copper conductors). All other data are provided as supplementary information only. For more details, please consult our CB, UL or CSA certificates and technical datasheet available on <http://www.TE.com>



Accessories

Description	Color	Type	Part Number	Pkg qty	Weight (1 pce) g	
1 End stops	Dark grey <input checked="" type="checkbox"/>	BAZH1	1SNK900102R0000	20	24.00	
2 End sections	Dark grey <input checked="" type="checkbox"/>	ES4-D2	1SNK505960R0000	20	4.10	
3 Jumper bars	Orange <input checked="" type="checkbox"/>	2 poles	JB5-2	1SNK905302R0000	50	1.30
		3 poles	JB5-3	1SNK905303R0000	50	2.00
		4 poles	JB5-4	1SNK905304R0000	50	2.70
		5 poles	JB5-5	1SNK905305R0000	50	3.50
		10 poles	JB5-10	1SNK905310R0000	30	7.10
		50 poles	JB5-50	1SNK905350R0000	10	36.00
4 Test adapters	Dark grey <input checked="" type="checkbox"/>	For test plugs DIA 2 mm 0.079 in	TP2	1SNK900203R0000	20	1.70
		For test plugs DIA 4 mm 0.157 in	TP4	1SNK900205R0000	20	2.40
5 Shield connectors		SHB	1SNK900602R0000	20	4.90	
6 Terminal block markers	White <input type="checkbox"/>	Blank marker	MG-CPM 13 41790	1SNB041790R0512	1960	0.23
		Blank card	MC512	1SNK140000R0000	22	9.00
		Universal wire markers holder	UMH	1SNK149999R0000	20	10.00
	Grey <input type="checkbox"/>			1SNK900611R0000	10	0.20

Complete list of accessories is indicated in the terminal block datasheet including end stops.

Some accessories such as jumper bars may modify the terminal block's ratings: Complete information available in the accessories section of the catalog.

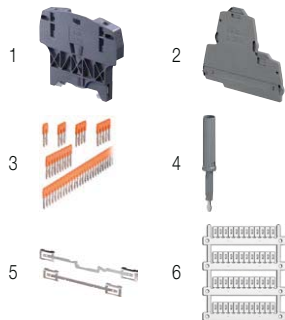

Technical data valid for copper conductors only.

ZS4-D2-SF1 screw clamp terminal blocks

Double deck with 1 fuse circuit and 1 feed-through circuit - 8 mm 0.315 in spacing



ZS4-D2-SF1

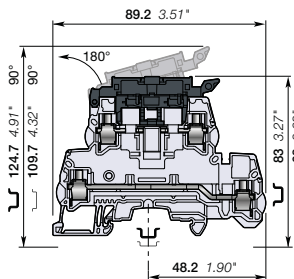

8 mm 0.315 in spacing

Description

- Save space: connect one complete circuit on a single block featuring fuse and feed-through for the return circuit,
- Protect your circuit with either 5X20 or 5X25 fuse (fuse not supplied with the terminal blocks),
- High performances product: compliant with IEC 60947-7-3 standard and jumper channel for the feed-through circuit.

Ordering details

Description	Color	Type	Part Number	Pkg qty	Weight (1 pce)
Feed-through + fuse	1 fuse circuit and 1 feed-through circuit	Grey, dark grey	ZS4-D2-SF1	1SNK508425R0000	50 27.50

Main technical data

Connecting capacity		IEC	UL - CSA	Mounting instructions	
1 conductor per clamp	Rigid: Solid/Stranded	0.2 ... 6 mm ²	24 ... 10 AWG	Rail	 TH 35-7.5, TH 35-15
	Flexible without ferrule	0.22 ... 4 mm ²	24 ... 10 AWG		
	Flexible with non insulated ferrule	0.22 ... 4 mm ²	24 ... 12 AWG	Wire stripping length	 11 mm 0.433 in
	Flexible with insulated ferrule	0.22 ... 4 mm ²	24 ... 12 AWG		
Gauge		A3-B3		Tool	 Flat screwdriver Ø 3.5 mm Ø 0.138 in
2 conductors per clamp	Rigid: Solid/Stranded	0.2 ... 2.5 mm ²	24 ... 14 AWG		
	Flexible without ferrule	0.2 ... 2.5 mm ²	24 ... 14 AWG		
	Flexible with twin ferrule	0.22 ... 2.5 mm ²	24 ... 14 AWG		
Disconnect circuit				Torque	 0.6 Nm ± 0.1 5.31 lb.in ± 0.885
Rated current / Rated cross section		6.3 A / 4 mm ²	12 A / 10 AWG		
Feed-through circuit					
Rated current / Rated cross section		32 A / 4 mm ²	30 A / 10 AWG		
Rated voltage		800 V	300 V		
Impulse withstand voltage		8000 V			
Protection		IP20	NEMA 1		

Separate arrangement		Assembly composed of 1 fuse terminal block in between non fuse terminal blocks	Overload and short-circuit protection	2.5 W
			Exclusive short-circuit protection	4 W
Compound arrangement		Assembly composed of 5 fuse terminal blocks	Overload and short-circuit protection	1.6 W
			Exclusive short-circuit protection	4 W

The connecting capacity data for one Rigid: Solid/Stranded, or one Flexible conductor (when applicable) is a mandatory information required by IEC, UL and CSA standards (Copper conductors). All other data are provided as supplementary information only. For more details, please consult our CB, UL or CSA certificates and technical datasheet available on <http://www.TE.com>

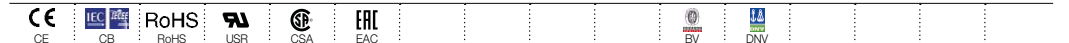

Accessories

Description	Color	Type	Part Number	Pkg qty	Weight (1 pce)	
1 End stops	Dark grey	BAZH1	1SNK900102R0000	20	24.00	
2 End sections	Dark grey	ES4-D2-SF1	1SNK508911R0000	20	5.00	
3 Jumper bars	Orange	2 poles	JB8-2	1SNK908302R0000	50	2.70
		3 poles	JB8-3	1SNK908303R0000	50	4.10
		4 poles	JB8-4	1SNK908304R0000	50	5.60
		5 poles	JB8-5	1SNK908305R0000	40	7.00
		10 poles	JB8-10	1SNK908310R0000	20	14.20
4 Lateral jumper bars	Grey	PC81-10	1SNA173523R1100	10	5.00	
5 Test adapters	Dark grey	For test plugs DIA 2 mm 0.079 in	TP2	1SNK900203R0000	20	1.70
		For test plugs DIA 4 mm 0.157 in	TP4	1SNK900205R0000	20	2.40
6 Test connectors	Dark grey	5.2 mm 0.205 in spacing	TC5	1SNK900200R0000	10	5.20
		End module, 5.2 mm 0.205 in	TC5-R1	1SNK900201R0000	10	5.20
7 Spacers	Dark grey	ES-TC8	1SNK900104R0000	10	1.40	
8 Assembly rods		2 poles	TGA8	1SNA168672R1100	10	1.00
		3 poles	TGA8	1SNA168673R1200	10	1.50
		4 poles	TGA8	1SNA168674R1300	10	2.00
9 Terminal block markers	White	Blank marker	MG-CPM 13 41791	1SNB041791R0612	1680	0.27
		Blank card	MC812	1SNK160000R0000	22	10.00
			MC812PA	1SNK169999R0000	20	14.00
	Universal wire markers holder	Grey	UMH	1SNK900611R0000	10	0.20

Complete list of accessories is indicated in the terminal block datasheet including end stops. Some accessories such as jumper bars may modify the terminal block's ratings: Complete information available in the accessories section of the catalog.

Technical data valid for copper conductors only.

ZS4-D2-SF1-R screw clamp terminal blocks

Double deck with 1 fuse circuit with blown fuse indicator and 1 feed-through circuit - 8 mm 0.315 in spacing

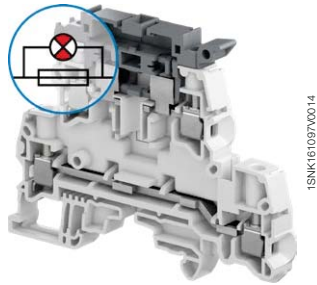

ZS4-D2-SF1-R

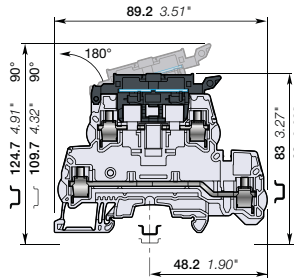

8 mm 0.315 in spacing

Description

- Find the same functionalities as ZS4-D2-SF1, upgraded with our integrated blown fuse indicator (with leakage current < 0.5 mA),
- Only one part number needed to fit AC / DC 24 V up to 110 V.

Ordering details

Description	Color	Type	Part Number	Pkg qty	Weight (1 pce) g
Feed-through + fuse	Grey, dark grey	ZS4-D2-SF1-R3	1SNK508424R0000	50	29.40
		ZS4-D2-SF1-R1	1SNK508423R0000	50	29.40

Main technical data

Connecting capacity	IEC	UL - CSA	Rail	Mounting instructions
1 conductor per clamp	Rigid: Solid/Stranded	0.2 ... 6 mm ²	24 ... 10 AWG	Wire stripping length
	Flexible without ferrule	0.22 ... 4 mm ²	24 ... 12 AWG	
	Flexible with non insulated ferrule	0.22 ... 4 mm ²	24 ... 12 AWG	
	Flexible with insulated ferrule	0.22 ... 4 mm ²	24 ... 12 AWG	
Gauge		A3-B3		
2 conductors per clamp	Rigid: Solid/Stranded	0.2 ... 2.5 mm ²	24 ... 14 AWG	Tool
	Flexible without ferrule	0.2 ... 2.5 mm ²	24 ... 14 AWG	
	Flexible with twin ferrule	0.22 ... 2.5 mm ²	24 ... 14 AWG	
Disconnect circuit				
Rated current / Rated cross section		6.3 A / 4 mm ²	12 A / 10 AWG	
Feed-through circuit				
Rated current / Rated cross section		32 A / 4 mm ²	30 A / 10 AWG	
Rated voltage		800 V	300 V	
Impulse withstand voltage		8000 V		
Protection		IP20	NEMA 1	Torque
				0.6 Nm ± 0.1 5.31 lb.in ± 0.885

Separate arrangement	Assembly composed of 1 fuse terminal block in between non fuse terminal blocks	Overload and short-circuit protection	2.5 W
		Exclusive short-circuit protection	4 W
Compound arrangement	Assembly composed of 5 fuse terminal blocks	Overload and short-circuit protection	1.6 W
		Exclusive short-circuit protection	4 W

The connecting capacity data for one Rigid: Solid/Stranded, or one Flexible conductor (when applicable) is a mandatory information required by IEC, UL and CSA standards (Copper conductors). All other data are provided as supplementary information only. For more details, please consult our CB, UL or CSA certificates and technical datasheet available on <http://www.TE.com>

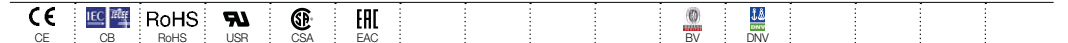

Accessories



Description	Color	Type	Part Number	Pkg qty	Weight (1 pce) g	
1 End stops	Dark grey	BAZH1	1SNK900102R0000	20	24.00	
2 End sections	Dark grey	ES4-D2-SF1	1SNK508911R0000	20	5.00	
3 Jumper bars	Orange	2 poles	JB8-2	1SNK908302R0000	50	2.70
		3 poles	JB8-3	1SNK908303R0000	50	4.10
		4 poles	JB8-4	1SNK908304R0000	50	5.60
		5 poles	JB8-5	1SNK908305R0000	40	7.00
		10 poles	JB8-10	1SNK908310R0000	20	14.20
4 Lateral jumper bars	Grey	PC81-10	1SNA173523R1100	10	5.00	
5 Test adapters	Dark grey	For test plugs DIA 2 mm 0.079 in	TP2	1SNK900203R0000	20	1.70
		For test plugs DIA 4 mm 0.157 in	TP4	1SNK900205R0000	20	2.40
6 Test connectors	Dark grey	5.2 mm 0.205 in spacing	TC5	1SNK900200R0000	10	5.20
		End module, 5.2 mm 0.205 in	TC5-R1	1SNK900201R0000	10	5.20
7 Spacers	Dark grey	ES-TC8	1SNK900104R0000	10	1.40	
8 Assembly rods	Dark grey	2 poles	TGA8	1SNA168672R1100	10	1.00
		3 poles	TGA8	1SNA168673R1200	10	1.50
		4 poles	TGA8	1SNA168674R1300	10	2.00
9 Terminal block markers	White	Blank marker	MG-CPM 13 41791	1SNB041791R0612	1680	0.27
		Blank card	MC812	1SNK160000R0000	22	10.00
			MC812PA	1SNK169999R0000	20	14.00
		Universal wire markers holder	UMH	1SNK900611R0000	10	0.20

Complete list of accessories is indicated in the terminal block datasheet including end stops.

Some accessories such as jumper bars may modify the terminal block's ratings: Complete information available in the accessories section of the catalog.

Technical data valid for copper conductors only.

ZS4-T3 screw clamp terminal blocks

Triple deck with 3 feed-through circuits - 5.2 mm 0.205 in spacing



ZS4-T3

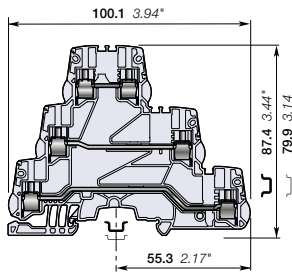

5.2 mm 0.205 in spacing

Description

Save space: 3 independent circuits in just 5.2 mm 0.205 in spacing,

- Fit many applications: space constraints, multiple signals distribution, sensors distribution, thanks to the jumper channels available on each deck.

Ordering details

Description	Color	Type	Part Number	Pkg qty	Weight (1 pce) g
Feed-through 3 feed-through circuits	Grey <input type="checkbox"/>	ZS4-T3	1SNK505212R0000	25	24.40

Main technical data

Connecting capacity		IEC	UL - CSA	Mounting instructions	
1 conductor per clamp	Rigid: Solid/Stranded	0.2 ... 4 mm ²	24 ... 12 AWG	Rail	TH 35-7.5, TH 35-15
	Flexible without ferrule	0.22 ... 4 mm ²		Wire stripping length	10.5 mm 0.413 in
	Flexible with non insulated ferrule	0.22 ... 4 mm ²	24 ... 12 AWG		
	Flexible with insulated ferrule	0.22 ... 2.5 mm ²	24 ... 14 AWG		
Gauge		A3-B3		Tool	Flat screwdriver Ø 3.5 mm Ø 0.138 in
2 conductors per clamp	Rigid: Solid/Stranded	0.2 ... 1.5 mm ²	24 ... 16 AWG		
	Flexible without ferrule	0.2 ... 1.5 mm ²			
Flexible with twin ferrule		0.22 ... 1.5 mm ²	24 ... 16 AWG	Torque	0.6 Nm ± 0.1 5.31 lb.in ± 0.885
Rated current / Rated cross section		32 A / 4 mm ²	20 A / 12 AWG		
Rated short-time withstand current (1s)		480 A			
Rated voltage		800 V	300 V		
Impulse withstand voltage		8000 V			
Protection		IP20	NEMA 1		

The connecting capacity data for one Rigid: Solid/Stranded, or one Flexible conductor (when applicable) is a mandatory information required by IEC, UL and CSA standards (Copper conductors). All other data are provided as supplementary information only. For more details, please consult our CB, UL or CSA certificates and technical datasheet available on <http://www.TE.com>

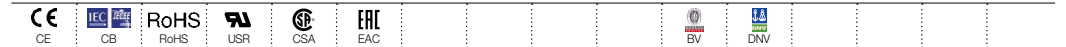

Accessories

Description	Color	Type	Part Number	Pkg qty	Weight (1 pce) g	
1 End stops 10 mm 0.394 in	Dark grey <input checked="" type="checkbox"/>	BAZH1	1SNK900102R0000	20	24.00	
2 End sections 0.8 mm 0.031 in	Dark grey <input checked="" type="checkbox"/>	ES4-T3	1SNK505961R0000	20	4.20	
3 Jumper bars	Orange <input checked="" type="checkbox"/>	2 poles 32 A (IEC)	JB5-2	1SNK905302R0000	50	1.30
		3 poles 32 A (IEC)	JB5-3	1SNK905303R0000	50	2.00
		4 poles 32 A (IEC)	JB5-4	1SNK905304R0000	50	2.70
		5 poles 32 A (IEC)	JB5-5	1SNK905305R0000	50	3.50
		10 poles 32 A (IEC)	JB5-10	1SNK905310R0000	30	7.10
		50 poles 32 A (IEC)	JB5-50	1SNK905350R0000	10	36.00
4 Test adapters	Dark grey <input checked="" type="checkbox"/>	For test plugs DIA 2 mm 0.079 in	TP2	1SNK900203R0000	20	1.70
		For test plugs DIA 4 mm 0.157 in	TP4	1SNK900205R0000	20	2.40
5 Label holders	Dark grey <input checked="" type="checkbox"/>	LH-J	1SNK900606R0000	100	0.73	
6 Terminal block markers	White <input type="checkbox"/>	Blank marker	MG-CPM 13 41790	1SNB041790R0512	1960	0.23
		Blank card	MC512	1SNK140000R0000	22	9.00
			MC512PA	1SNK149999R0000	20	10.00
		Universal wire markers holder	Grey <input type="checkbox"/>	UMH	1SNK900611R0000	10

Complete list of accessories is indicated in the terminal block datasheet including end stops.

Some accessories such as jumper bars may modify the terminal block's ratings: Complete information available in the accessories section of the catalog.

Technical data valid for copper conductors only.

ZS4-T3-R1 screw clamp terminal blocks

Triple deck with 3 feed-through circuits - 6 mm 0.236 in spacing

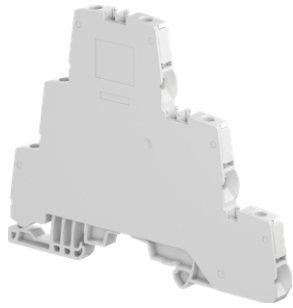

ZS4-T3-R1

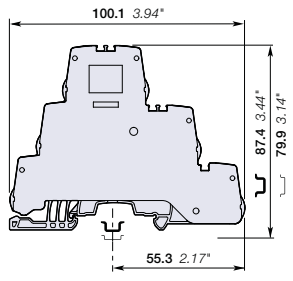

6 mm 0.236 in spacing

Description

Unique triple deck solution combining increased connecting capacity (up to 4 mm² with ferrule) and jumper channel available on each deck,

- Fit many applications: space constraints, multiple signals distribution, sensors distribution,
- Closed terminal block: no end section needed, optimized rigidity.

Ordering details

Description	Color	Type	Part Number	Pkg qty	Weight (1 pce) g
Feed-through Closed block with 3 feed-through circuits	Grey <input type="checkbox"/>	ZS4-T3-R1	1SNK506213R0000	50	28.30

Main technical data

Connecting capacity		IEC	UL - CSA	Mounting instructions	
1 conductor per clamp	Rigid: Solid/Stranded	0.2 ... 4 mm ²	24 ... 10 AWG	Rail	TH 35-7.5, TH 35-15
	Flexible without ferrule	0.22 ... 4 mm ²		Wire stripping length	10.5 mm 0.413 in
	Flexible with non insulated ferrule	0.22 ... 4 mm ²	24 ... 12 AWG		
	Flexible with insulated ferrule	0.22 ... 4 mm ²	24 ... 12 AWG		
	Gauge	A3-B3			
2 conductors per clamp	Rigid: Solid/Stranded	0.2 ... 1.5 mm ²	24 ... 16 AWG	Tool	Flat screwdriver Ø 3.5 mm Ø 0.138 in
	Flexible without ferrule	0.2 ... 1.5 mm ²			
	Flexible with twin ferrule	0.22 ... 1.5 mm ²	24 ... 16 AWG		
Rated current / Rated cross section		32 A / 4 mm ²	30 A / 10 AWG	Torque	0.6 Nm ± 0.1 5.31 lb.in ± 0.885
Rated short-time withstand current (1s)		480 A			
Rated voltage		800 V	300 V		
Impulse withstand voltage		8000 V			
Protection		IP20	NEMA 1		

The connecting capacity data for one Rigid: Solid/Stranded, or one Flexible conductor (when applicable) is a mandatory information required by IEC, UL and CSA standards (Copper conductors). All other data are provided as supplementary information only. For more details, please consult our CB, UL or CSA certificates and technical datasheet available on <http://www.TE.com>

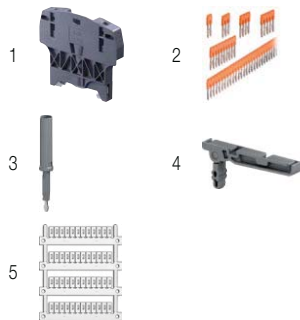
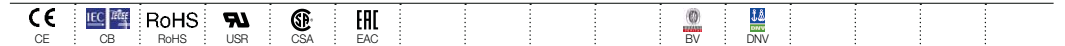

Accessories

Description	Color	Type	Part Number	Pkg qty	Weight (1 pce) g	
1 End stops	Dark grey <input checked="" type="checkbox"/>	BAZH1	1SNK900102R0000	20	24.00	
2 Jumper bars	Orange <input checked="" type="checkbox"/>	2 poles	JB6-2	1SNK906302R0000	50	1.30
		3 poles	JB6-3	1SNK906303R0000	50	2.10
		4 poles	JB6-4	1SNK906304R0000	50	2.90
		5 poles	JB6-5	1SNK906305R0000	50	3.60
		10 poles	JB6-10	1SNK906310R0000	20	7.40
3 Test adapters	Dark grey <input checked="" type="checkbox"/>	For test plugs DIA 2 mm 0.079 in	TP2	1SNK900203R0000	20	1.70
		For test plugs DIA 4 mm 0.157 in	TP4	1SNK900205R0000	20	2.40
4 Label holders	Dark grey <input checked="" type="checkbox"/>	LH-J	1SNK900606R0000	100	0.73	
5 Terminal block markers	White <input checked="" type="checkbox"/>	Blank marker	MG-CPM 13 41791	1SNB041791R0612	1680	0.27
		Blank card	MC512	1SNK140000R0000	22	9.00
			MC512PA	1SNK149999R0000	20	10.00
		Universal wire markers holder	Grey <input type="checkbox"/>	UMH	1SNK900611R0000	10

Complete list of accessories is indicated in the terminal block datasheet including end stops. Some accessories such as jumper bars may modify the terminal block's ratings: Complete information available in the accessories section of the catalog.

Technical data valid for copper conductors only.

ZS4-D-CH-UD screw clamp terminal blocks

Component holder - 5.2 mm 0.205 in spacing

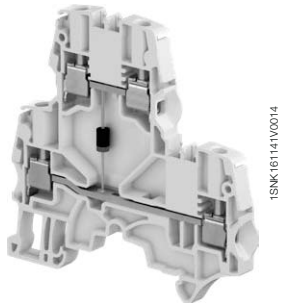

ZS4-D-CH

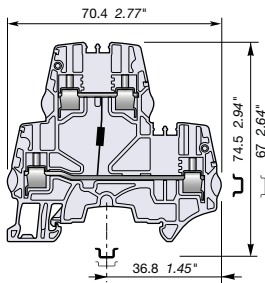

5.2 mm 0.205 in spacing

Description

Protect your circuit with one 1N4007 diode.

Ordering details

Description	Color	Type	Part Number	Pkg qty	Weight (1 pce) g
Component holder Cathode of the blocking diode connected to the lower circuit	Grey <input type="checkbox"/>	ZS4-D-CH-UD	1SNK505214R0000	50	15.30

Main technical data

Connecting capacity		IEC	UL - CSA	Mounting instructions	
1 conductor per clamp	Rigid: Solid/Stranded	0.2 ... 4 mm ²	24 ... 12 AWG	Rail	TH 35-7.5, TH 35-15
	Flexible without ferrule	0.22 ... 4 mm ²		Wire stripping length	10 mm 0.393 in
	Flexible with non insulated ferrule	0.22 ... 4 mm ²	24 ... 12 AWG	Tool	Flat screwdriver Ø 3.5 mm Ø 0.138 in
	Flexible with insulated ferrule	0.22 ... 2.5 mm ²	24 ... 14 AWG		
Gauge		A3-B3		Torque	0.6 Nm ± 0.1 5.31 lb.in ± 0.885
2 conductors per clamp	Rigid: Solid/Stranded	0.2 ... 1.5 mm ²	24 ... 16 AWG		
		Flexible without ferrule	0.2 ... 1.5 mm ²		
		Flexible with twin ferrule	0.22 ... 1.5 mm ²		
Rated current / Rated cross section		29 A / 4 mm ²	20 A / 12 AWG		
Rated short-time withstand current (1s)		480 A			
Short Circuit Current Rating (with specific conditions)					
Rated voltage		800 V	300 V		
Impulse withstand voltage					
Protection		IP20	NEMA 1		

The connecting capacity data for one Rigid: Solid/Stranded, or one Flexible conductor (when applicable) is a mandatory information required by IEC, UL and CSA standards (Copper conductors). All other data are provided as supplementary information only. For more details, please consult our CB, UL or CSA certificates and technical datasheet available on <http://www.TE.com>

CE	RoHS	UL	CSA	EAC
CE	RoHS	UL	CSA	EAC

Accessories

Description	Color	Type	Part Number	Pkg qty	Weight (1 pce) g	
1 End stops	Dark grey <input checked="" type="checkbox"/>	BAZH1	1SNK900102R0000	20	24.00	
2 End sections	Dark grey <input checked="" type="checkbox"/>	ES4-D2	1SNK505960R0000	20	4.10	
3 Jumper bars	Orange <input checked="" type="checkbox"/>	2 poles	JB5-2	1SNK905302R0000	50	1.30
		3 poles	JB5-3	1SNK905303R0000	50	2.00
		4 poles	JB5-4	1SNK905304R0000	50	2.70
		5 poles	JB5-5	1SNK905305R0000	50	3.50
		10 poles	JB5-10	1SNK905310R0000	30	7.10
4 Test adapters	Dark grey <input checked="" type="checkbox"/>	For test plugs DIA 2 mm 0.079 in	TP2	1SNK900203R0000	20	1.70
		For test plugs DIA 4 mm 0.157 in	TP4	1SNK900205R0000	20	2.40
5 Test connectors	Dark grey <input checked="" type="checkbox"/>	5.2 mm 0.205 in spacing	TC5	1SNK900200R0000	10	5.20
		End module, 5.2 mm 0.205 in	TC5-R1	1SNK900201R0000	10	5.20
6 Shield connectors		SHB	1SNK900602R0000	20	4.90	
7 Label holders	Dark grey <input checked="" type="checkbox"/>	LH-J	1SNK900606R0000	100	0.73	
8 Terminal block markers	White <input type="checkbox"/>	Blank marker	MG-CPM 13 41790	1960	0.23	
		Blank card	MC512	1SNK140000R0000	22	9.00
	Grey <input type="checkbox"/>		MC512PA	1SNK149999R0000	20	10.00
		Universal wire markers holder	UMH	1SNK900611R0000	10	0.20

Complete list of accessories is indicated in the terminal block datasheet including end stops. Some accessories such as jumper bars may modify the terminal block's ratings: Complete information available in the accessories section of the catalog.

Technical data valid for copper conductors only.

ZS4-D-CH-DU screw clamp terminal blocks

Component holder - 5.2 mm 0.205 in spacing



Description

Protect your circuit with one 1N4007 diode.

Ordering details

Description	Color	Type	Part Number	Pkg qty	Weight (1 pce) g
Component holder Cathode of the blocking diode connected to the upper circuit	Grey <input type="checkbox"/>	ZS4-D-CH-DU	1SNK505215R0000	50	15.30

Main technical data

Connecting capacity		IEC	UL - CSA	Mounting instructions	
1 conductor per clamp	Rigid: Solid/Stranded	0.2 ... 4 mm ²	24 ... 12 AWG	Rail	TH 35-7.5, TH 35-15
	Flexible without ferrule	0.22 ... 4 mm ²		Wire stripping length	10 mm 0.393 in
	Flexible with non insulated ferrule	0.22 ... 4 mm ²	24 ... 12 AWG	Tool	Flat screwdriver Ø 3.5 mm Ø 0.138 in
	Flexible with insulated ferrule	0.22 ... 2.5 mm ²	24 ... 14 AWG		
Gauge		A3-B3		Torque	0.6 Nm ± 0.1 5.31 lb.in ± 0.885
2 conductors per clamp		Rigid: Solid/Stranded	0.2 ... 1.5 mm ²		
		Flexible without ferrule	0.2 ... 1.5 mm ²	24 ... 16 AWG	
		Flexible with twin ferrule	0.22 ... 1.5 mm ²	24 ... 16 AWG	
Rated current / Rated cross section		29 A / 4 mm ²	20 A / 12 AWG		
Rated short-time withstand current (1s)		480 A			
Short Circuit Current Rating (with specific conditions)					
Rated voltage		800 V	300 V		
Impulse withstand voltage					
Protection		IP20	NEMA 1		

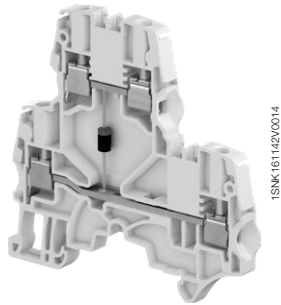

ZS4-D-CH

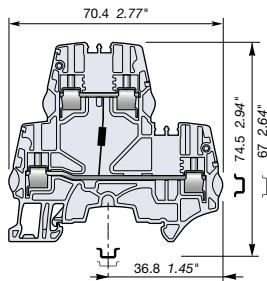

5.2 mm 0.205 in spacing

The connecting capacity data for one Rigid: Solid/Stranded, or one Flexible conductor (when applicable) is a mandatory information required by IEC, UL and CSA standards (Copper conductors). All other data are provided as supplementary information only. For more details, please consult our CB, UL or CSA certificates and technical datasheet available on <http://www.TE.com>



Accessories

Description	Color	Type	Part Number	Pkg qty	Weight (1 pce) g	
1 End stops 10 mm 0.394 in	Dark grey <input checked="" type="checkbox"/>	BAZH1	1SNK900102R0000	20	24.00	
2 End sections 2.55 mm 0.100 in	Dark grey <input checked="" type="checkbox"/>	ES4-D2	1SNK505960R0000	20	4.10	
3 Jumper bars	Orange <input checked="" type="checkbox"/>	2 poles 32 A (IEC)	JB5-2	1SNK905302R0000	50	1.30
		3 poles 32 A (IEC)	JB5-3	1SNK905303R0000	50	2.00
		4 poles 32 A (IEC)	JB5-4	1SNK905304R0000	50	2.70
		5 poles 32 A (IEC)	JB5-5	1SNK905305R0000	50	3.50
		10 poles 32 A (IEC)	JB5-10	1SNK905310R0000	30	7.10
		50 poles 32 A (IEC)	JB5-50	1SNK905350R0000	10	36.00
4 Test adapters	Dark grey <input checked="" type="checkbox"/>	For test plugs DIA 2 mm 0.079 in	TP2	1SNK900203R0000	20	1.70
		For test plugs DIA 4 mm 0.157 in	TP4	1SNK900205R0000	20	2.40
5 Test connectors	Dark grey <input checked="" type="checkbox"/>	5.2 mm 0.205 in spacing	TC5	1SNK900200R0000	10	5.20
		End module, 5.2 mm 0.205 in	TC5-R1	1SNK900201R0000	10	5.20
			SHB	1SNK900602R0000	20	4.90
6 Shield connectors						
7 Label holders	Dark grey <input checked="" type="checkbox"/>	LH-J	1SNK900606R0000	100	0.73	
8 Terminal block markers	White <input type="checkbox"/>	Blank marker	MG-CPM 13 41790	1SNB041790R0512	1960	0.23
		Blank card	MC512	1SNK140000R0000	22	9.00
			MC512PA	1SNK149999R0000	20	10.00
	Universal wire markers holder	Grey <input type="checkbox"/>	UMH	1SNK900611R0000	10	0.20

Complete list of accessories is indicated in the terminal block datasheet including end stops. Some accessories such as jumper bars may modify the terminal block's ratings. Complete information available in the accessories section of the catalog.

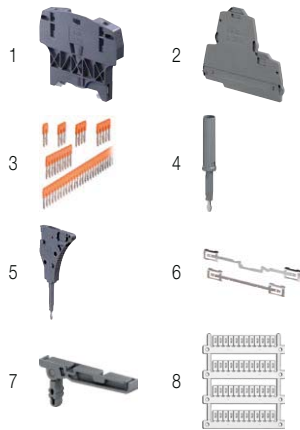

Technical data valid for copper conductors only.

SNK series, terminal blocks

Screw clamp technology - Test & measurement

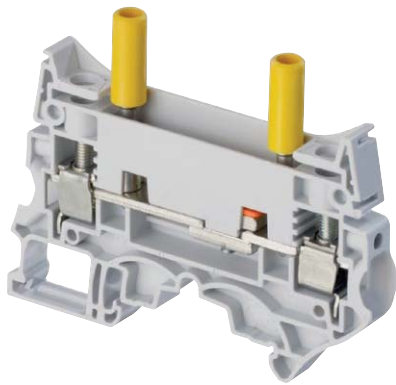

Secure your measurement operations

The new ZS10-ST test & measurement terminal blocks benefit from our long experience in the energy applications and from the SNK features: performances, ergonomics, common accessories and marking.

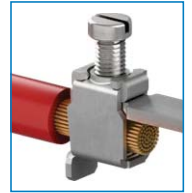

High performances

- 10 mm² 6 AWG
- 6 mm² 10 AWG with ferrule
- 50 A (IEC) 53 A (UL)
- Worldwide certifications



Rely on our smart design

Insulated short circuit bridges:
SC-JB8

Insulated captive test sockets:
AJS9
6 colors
compatible with standard
DIA. 4 mm test plugs
(IEC 60010-031)

Circuit separators: CS
For visual separation between
CT & PT circuits

Protecting cover kits: KCO

New ground terminal block:
ZS10-PE-R1

Lateral jumper bar: PC8
For CT or PT commoning

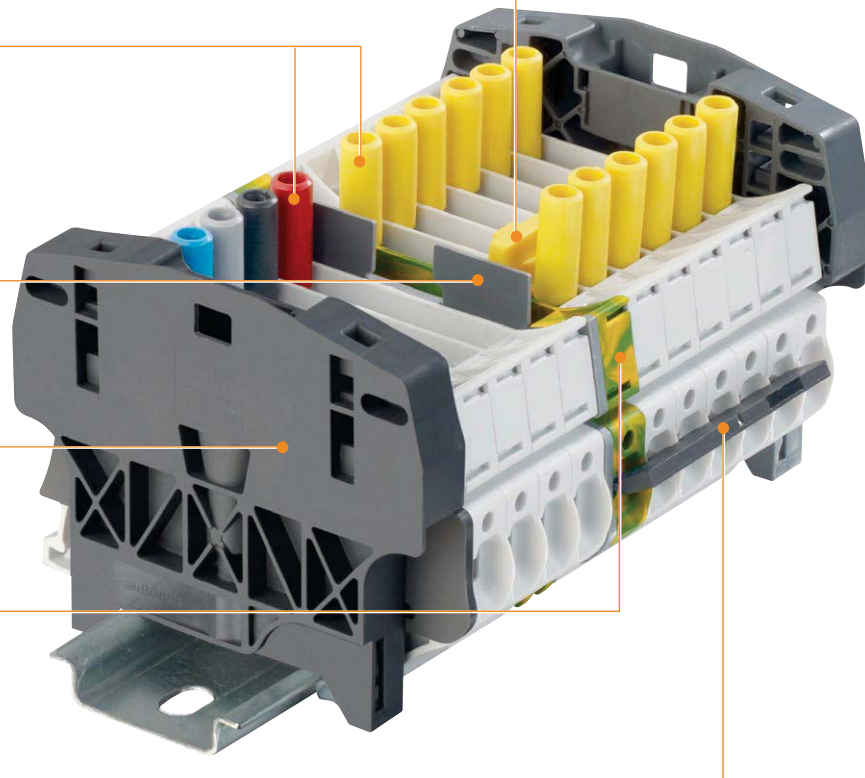

1SNK160057S0201



Assembly with protecting cover



Drilling and centering guide

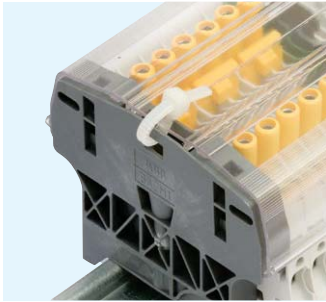

Seal with cable tie

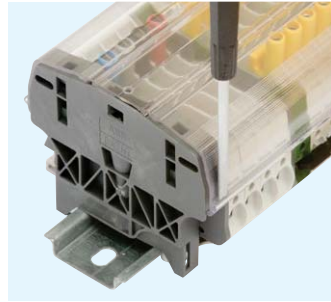

Convenient removal with screwdriver

Guarantee access only to authorized operators

cover can be permanently sealed with a seal or cable tie.

Centering drilling guide for seal or cable tie.

The cover is specially designed to ease its mounting or removal:

- Hook shape on each side for convenient removal with screwdriver

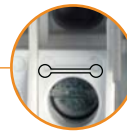
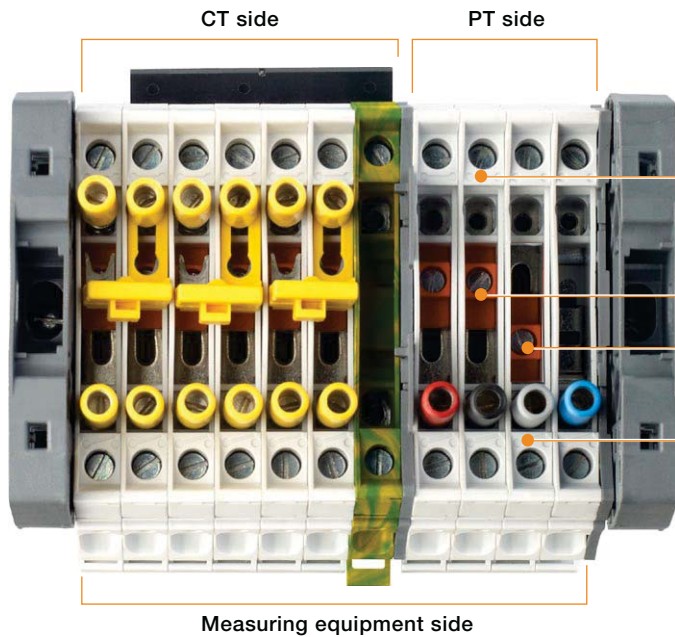

sliding link status: closed

Disconnect sliding link status:
Open and close symbols help to visualize the sliding link position

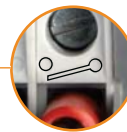

sliding link status: opened



1



2

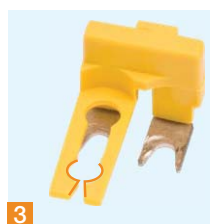

3

Short-circuit CT circuits safely and conveniently

- 1 Fully operated by screwdriver (DIA 3.5 mm)
- 2 Short-circuited position secured thanks to AJS9 test sockets tightening
- 3 Adapted hook shape maintain the bridge on terminal block in the non connected position

TSNK160057S0201

SNK series, terminal blocks

Test & measurement - Typical schematic for measuring devices

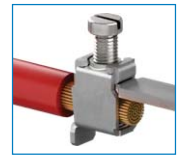

Common point on the transformers

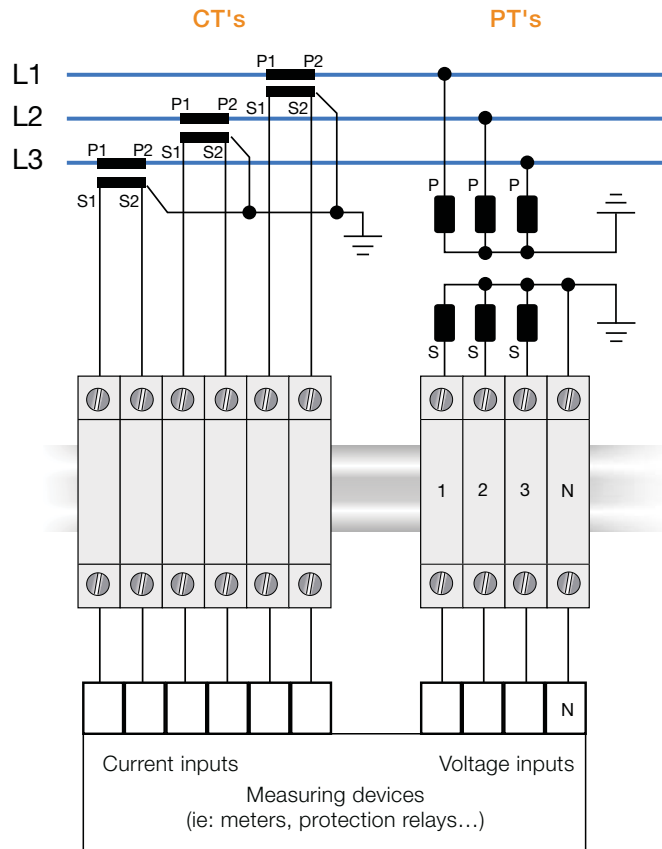

Bill of material optimized

Bill of material with convenient customization (test sockets, feed-through terminals...)

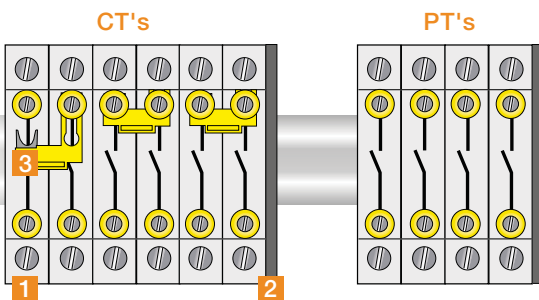

Description	Type	Order code	Qty needed	
			CT's	PT's
1 Terminal block	ZS10-ST-T4	1SNK508311R0000	6	4
2 End section	ES10-ST	1SNK508910R0000	1	1
3 Short-circuit bridges	SC-JB8-2	1SNK900652R0000	3	0

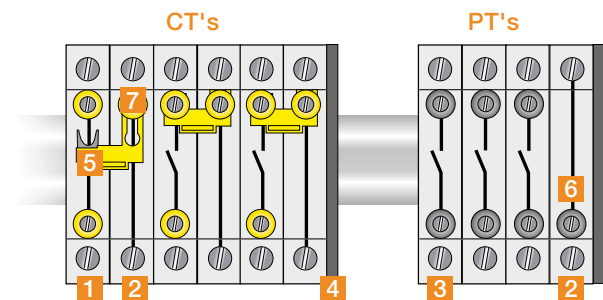

Description	Type	Order code	Qty needed	
			CT's	PT's
1 Terminal block	ZS10-ST-T4	1SNK508311R0000	3	0
2 Terminal block	ZS10-R1	1SNK508011R0000	3	1
3 Terminal block	ZS10-ST-1	1SNK508312R0000	0	3
4 End section	ES10-ST	1SNK508910R0000	1	1
5 Short-circuit bridges	SC-JB8-2	1SNK900652R0000	3	0
6 Test socket	AL4-M3	1SNA206721R0100	0	1
7 Insulated test socket	AJS9	1SNA179726R0200	3	0

1SNK160058S0201

SNK series, terminal blocks

Test & measurement - Typical schematic for measuring devices

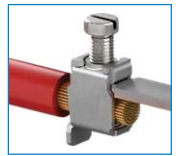

Common point on the terminal block assembly

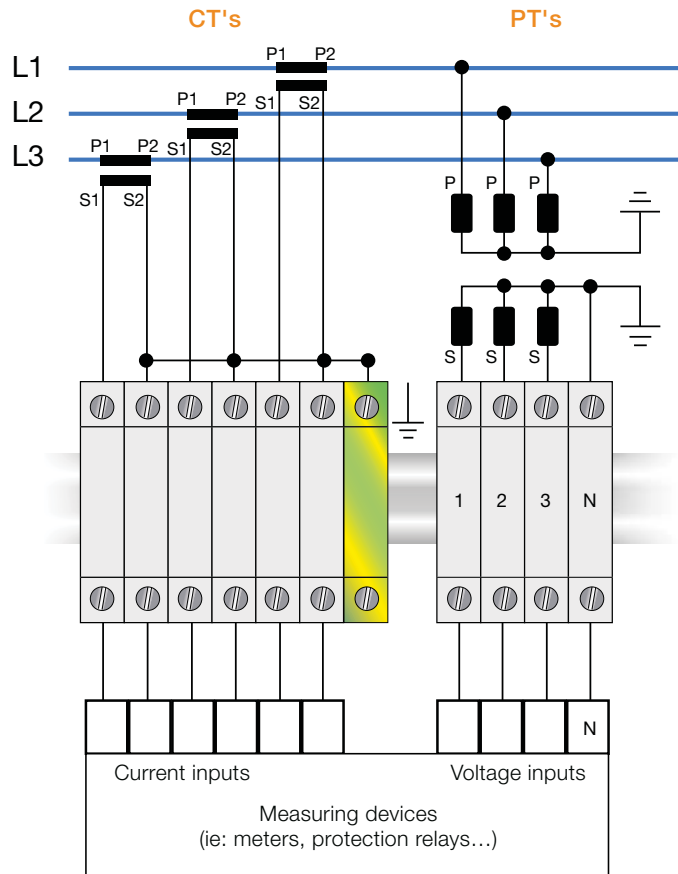

Bill of material optimized

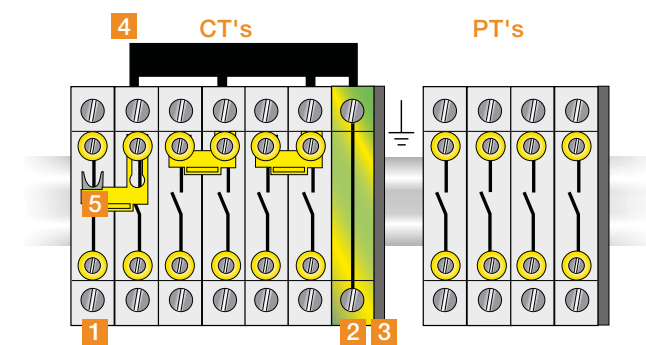

Description	Type	Order code	Qty needed	
			CT's	PT's
1 Terminal block	ZS10-ST-T4	1SNK508311R0000	6	4
2 Terminal block	ZS10-PE-R1	1SNK508151R0000	1	0
3 End section	ES10-ST	1SNK508910R0000	1	1
4 Lateral jumper bars	PC8-R1	1SNA400711R0600	1	0
5 Short-circuit bridges	SC-JB8-2	1SNK900652R0000	3	0

Bill of material with convenient customization (test sockets, feed-through terminals...)

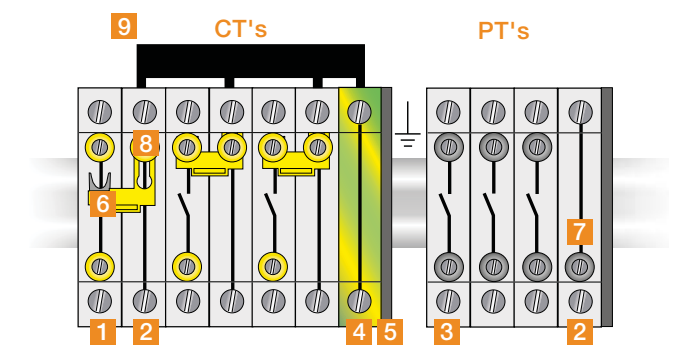

Description	Type	Order code	Qty needed	
			CT's	PT's
1 Terminal block	ZS10-ST-T4	1SNK508311R0000	3	0
2 Terminal block	ZS10-R1	1SNK508011R0000	3	1
3 Terminal block	ZS10-ST-1	1SNK508312R0000	0	3
4 Terminal block	ZS10-PE-R1	1SNK508151R0000	1	0
5 End section	ES10-ST	1SNK508910R0000	1	1
6 Short-circuit bridges	SC-JB8-2	1SNK900652R0000	3	0
7 Test socket	AL4-M3	1SNA206721R0100	0	1
8 Insulated test socket	AJS9	1SNA179726R0200	3	0
9 Lateral jumper bars	PC8-R1	1SNA400711R0600	1	0

8

1SNK160058S0201

ZS10-ST screw clamp terminal blocks

Test disconnect with sliding link - 8 mm 0.315 in spacing



ZS10-ST

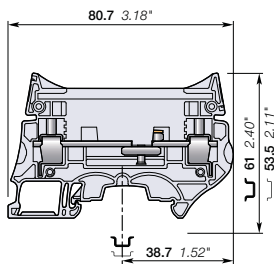

8 mm 0.315 in spacing

Description

- Secure your disconnect operations in control circuits with the robust sliding link operated with a screwdriver,
- Customize ZS10-ST with colored test sockets in order to identify conveniently each phase of the Current Transformer or Potential Transformers secondary circuits,
- Fully compatible with the ZS10-ST-T4 accessories.

Ordering details

Description	Color	Type	Part Number	Pkg qty	Weight (1 pce)
Disconnect	Grey	ZS10-ST	1SNK508310R0000	25	24.80

Main technical data

Connecting capacity		IEC	UL - CSA	Mounting instructions	
1 conductor per clamp	Rigid: Solid/Stranded	0.5 ... 10 mm ²	24 ... 6 AWG	Rail	TH 35-7.5, TH 35-15
	Flexible without ferrule	0.5 ... 10 mm ²		Wire stripping length	13 mm 0.512 in
	Flexible with non insulated ferrule	0.5 ... 10 mm ²	24 ... 8 AWG	Screw clamp Tool	Flat screwdriver Ø 3.5 mm Ø 0.138 in
	Flexible with insulated ferrule	0.5 ... 6 mm ²	24 ... 10 AWG		
2 conductors per clamp	Rigid: Solid/Stranded	0.5 ... 4 mm ²	20 ... 12 AWG	Torque	1.3 Nm ± 0.3 11.5 lb.in ± 2.65
	Flexible without ferrule	0.5 ... 4 mm ²			
	Flexible with twin ferrule	0.5 ... 4 mm ²	20 ... 12 AWG		
Rated current / Rated cross section		50 A / 10 mm ²	53 A / 6 AWG	Disconnect device Tool	Flat screwdriver Ø 3.5 mm Ø 0.138
Rated short-time withstand current (1s)		1200 A			
Rated voltage		630 V	300 V	Torque	0.4 Nm ... 0.6 Nm 3.5 lb.in ... 5.3 lb.in
Impulse withstand voltage		8000 V			
Protection		IP20	NEMA 1		

The connecting capacity data for one Rigid: Solid/Stranded, or one Flexible conductor (when applicable) is a mandatory information required by IEC, UL and CSA standards (Copper conductors). All other data are provided as supplementary information only. For more details, please consult our CB, UL or CSA certificates and technical datasheet available on <http://www.TE.com>



Accessories

Description	Color	Type	Part Number	Pkg qty	Weight (1 pce)	
1 End stops	Dark grey	BAM4	1SNK900001R0000	50	14.00	
2 End sections	Dark grey	ES10-ST	1SNK508910R0000	20	3.5	
3 Jumper bars	Orange	2 poles 50 A (IEC)	JB8-2-R1	1SNK908902R0000	10	7.6
		3 poles 50 A (IEC)	JB8-3-R1	1SNK908903R0000	10	11.6
		4 poles 50 A (IEC)	JB8-4-R1	1SNK908904R0000	10	15.5
		5 poles 50 A (IEC)	JB8-5-R1	1SNK908905R0000	10	19.4
		10 poles 50 A (IEC)	JB8-10-R1	1SNK908910R0000	10	39.00
4 Circuit separators	Dark grey	CS-R3	1SNK900107R0000	20	6.40	
5 Test sockets	Yellow	AJS9	1SNA179726R0200	25	3.60	
	Black	AJS9-BK	1SNA206680R1500	25	3.60	
	Green	AJS9-GN	1SNA206681R0200	25	3.60	
	Grey	AJS9-GR	1SNA206682R0300	25	3.60	
	Blue	AJS9-BL	1SNA206683R0400	25	3.60	
	Red	AJS9-RD	1SNA206720R1400	25	3.60	
	White	AJS9-WH	1SNA206765R0000	25	3.60	
	Purple	AJS9-PR	1SNA206772R0000	25	3.60	
	Brown	AJS9-BR	1SNA206782R0000	25	3.60	
			AL4-M3	1SNA206721R0100	50	1.10
6 Terminal block markers	White	MG-CPM 13 41791	1SNB041791R0612	1680	0.27	
		MC812	1SNK160000R0000	22	10.00	
		MC812PA	1SNK169999R0000	20	14.00	
		Universal wire markers holder	UMH	1SNK900611R0000	10	0.20

Complete list of accessories is indicated in the terminal block datasheet including end stops. Some accessories such as jumper bars may modify the terminal block's ratings: Complete information available in the accessories section of the catalog.

Screw clamp terminal blocks

Description	Color	Type	Part Number	Pkg qty	Weight (1 pce)
Feed-through	Grey	ZS10-R1	1SNK508011R0000	25	20.90
Ground	Green-yellow	ZS10-PE-R1	1SNK508151R0000	25	28.40



ZS10-R1



ZS10-PE-R1

Technical data valid for copper conductors only.

ZS10-ST-1 screw clamp terminal blocks

Test disconnect with sliding link for Potential Transformer circuits - 8 mm 0.315 in spacing



10 mm²
6 AWG

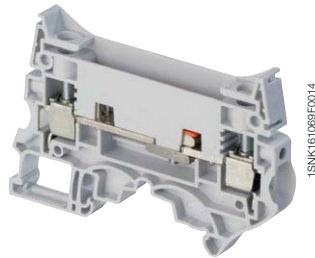

1SNK161069F0014

ZS10-ST-1

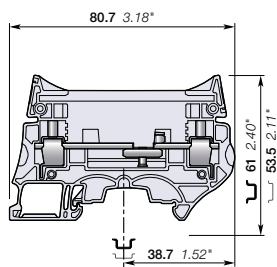

8 mm 0.315 in spacing

Description

Test terminal blocks especially designed for Potential Transformers circuits:

- low profile voltage measurement thanks to the two compact built-in test sockets compatible with DIA 4 mm 0.157 in test plugs,
- Installed with our aligned feed-through and ground terminal blocks, you benefit of a complete and compact solution for your PT circuits.

Ordering details

Description	Color	Type	Part Number	Pkg qty	Weight (1 pce) g
Disconnect With 2 test sockets DIA 4 mm 0.157 in	Grey <input type="checkbox"/>	ZS10-ST-1	1SNK508312R0000	25	27.00

Main technical data

Connecting capacity		IEC	UL - CSA	Mounting instructions	
1 conductor per clamp	Rigid: Solid/Stranded	0.5 ... 10 mm ²	24 ... 6 AWG	Rail	TH 35-7.5, TH 35-15
	Flexible without ferrule	0.5 ... 10 mm ²		Wire stripping length	13 mm 0.512 in
	Flexible with non insulated ferrule	0.5 ... 10 mm ²	24 ... 8 AWG	Screw clamp Tool	Flat screwdriver Ø 3.5 mm Ø 0.138 in
	Flexible with insulated ferrule	0.5 ... 6 mm ²	24 ... 10 AWG		
Gauge		A5-B5		Torque	1.3 Nm ± 0.3 11.5 lb.in ± 2.65
2 conductors per clamp	Rigid: Solid/Stranded	0.5 ... 4 mm ²	20 ... 12 AWG	Disconnect device Tool	Flat screwdriver Ø 3.5 mm Ø 0.138 in
	Flexible without ferrule	0.5 ... 4 mm ²			
	Flexible with twin ferrule	0.5 ... 4 mm ²	20 ... 12 AWG		
Rated current / Rated cross section		50 A / 10 mm ²	53 A / 6 AWG	Torque	0.4 Nm ... 0.6 Nm 3.5 lb.in ... 5.3 lb.in
Rated short-time withstand current (1s)		1200 A			
Rated voltage		630 V	300 V		
Impulse withstand voltage		8000 V			
Protection		IP10	NEMA 1		

The connecting capacity data for one Rigid: Solid/Stranded, or one Flexible conductor (when applicable) is a mandatory information required by IEC, UL and CSA standards (Copper conductors). All other data are provided as supplementary information only. For more details, please consult our CB, UL or CSA certificates and technical datasheet available on <http://www.TE.com>

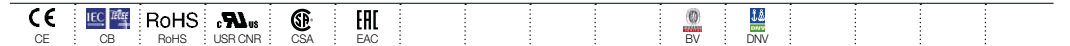

Accessories

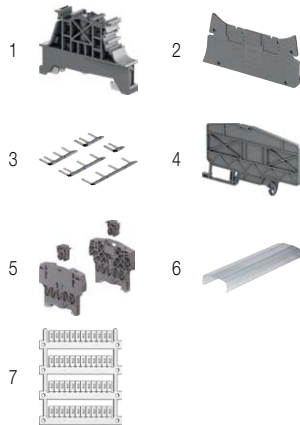

Description	Color	Type	Part Number	Pkg qty	Weight (1 pce) g
1 End stops 10 mm 0.394 in	Dark grey <input type="checkbox"/>	BAM4	1SNK900001R0000	50	14.00
2 End sections 2 mm 0.079 in	Dark grey <input type="checkbox"/>	ES10-ST	1SNK508910R0000	20	3.5
3 Lateral jumper bars 10 poles	Black <input type="checkbox"/>	PC8-10	1SNA163313R2400	10	14.00
		PC8-R1	1SNA400711R0600	10	6.60
		PC8-R2	1SNA400712R0700	10	7.80
		PC8-R3	1SNA400713R0000	10	9.00
		PC8-R4	1SNA400724R0300	10	4.50
		PC8-R5	1SNA400842R0000	10	6.60
		PC8-R6	1SNA400843R0000	10	6.60
		PC8-R7	1SNA400849R0000	10	6.60
PC8-R8	1SNA400850R0000	10	7.80		
4 Circuit separators 3 mm 0.118 in	Dark grey <input type="checkbox"/>	CS-R3	1SNK900107R0000	20	6.40
5 Protecting cover kits	Dark grey <input type="checkbox"/>	KCO	1SNK900624R0000	1	47.80
6 Protecting covers 1 m 39.4 in length	Transparent <input checked="" type="checkbox"/>	CO	1SNK900604R0000	1	300.00
7 Terminal block markers	White <input type="checkbox"/>	MG-CPM 13 41791	1SNB041791R0612	1680	0.27
		MC812	1SNK160000R0000	22	10.00
		MC812PA	1SNK169999R0000	20	14.00
		Universal wire markers holder	Grey <input type="checkbox"/>	UMH	1SNK900611R0000

Complete list of accessories is indicated in the terminal block datasheet including end stops.

Some accessories such as jumper bars may modify the terminal block's ratings: Complete information available in the accessories section of the catalog.

Screw clamp terminal blocks

Description	Color	Type	Part Number	Pkg qty	Weight (1 pce) g
Feed-through Profile aligned with ZS10-ST...	Grey <input type="checkbox"/>	ZS10-R1	1SNK508011R0000	25	20.90
Ground Profile aligned with ZS10-ST...	Green-yellow <input type="checkbox"/>	ZS10-PE-R1	1SNK508151R0000	25	28.40



ZS10-R1



ZS10-PE-R1

Technical data valid for copper conductors only.

ZS10-ST-T4 screw clamp terminal blocks

Test disconnect with sliding link for Current Transformer circuits - 8 mm 0.315 in spacing



10 mm²
6 AWG

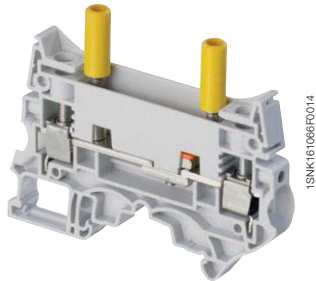

ZS10-ST-T4

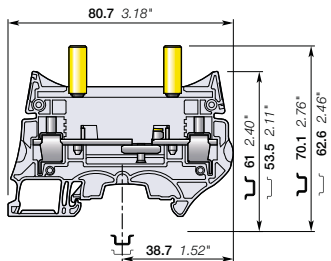

8 mm 0.315 in spacing

Description

Test terminal blocks especially designed for Current Transformers circuits:

- easy and safe current measurement thanks to the two insulated built-in test sockets compatible with IP20 DIA 4 mm 0.157 in test plugs (per IEC60101-031),
- convenient short-circuit operations with the SC-JB insulated sliding bridges.

Ordering details

Description	Color	Type	Part Number	Pkg qty	Weight (1 pce) g
Disconnect With two yellow test sockets DIA 4 mm 0.157 in	Grey <input type="checkbox"/>	ZS10-ST-T4	1SNK508311R0000	25	31.90

Main technical data

Connecting capacity		IEC	UL - CSA	Mounting instructions	
1 conductor per clamp	Rigid: Solid/Stranded	0.5 ... 10 mm ²	24 ... 6 AWG	Rail	TH 35-7.5, TH 35-15
	Flexible without ferrule	0.5 ... 10 mm ²	24 ... 8 AWG	Wire stripping length	13 mm 0.512 in
	Flexible with non insulated ferrule	0.5 ... 10 mm ²	24 ... 8 AWG	Screw clamp Tool	Flat screwdriver Ø 3.5 mm Ø 0.138 in
	Flexible with insulated ferrule	0.5 ... 6 mm ²	24 ... 10 AWG		
Gauge		A5-B5		Torque	1.3 Nm ± 0.3 11.5 lb.in ± 2.65
2 conductors per clamp	Rigid: Solid/Stranded	0.5 ... 4 mm ²	20 ... 12 AWG	Disconnect device Tool	Flat screwdriver Ø 3.5 mm Ø 0.138
	Flexible without ferrule	0.5 ... 4 mm ²	20 ... 12 AWG		
	Flexible with twin ferrule	0.5 ... 4 mm ²	20 ... 12 AWG		
Rated current / Rated cross section		50 A / 10 mm ²	53 A / 6 AWG	Torque	0.4 Nm ... 0.6 Nm 3.5 lb.in ... 5.3 lb.in
Rated short-time withstand current (1s)		1200 A			
Rated voltage		630 V	300 V	Test socket Tool	Flat screwdriver Ø 3.5 mm Ø 0.138
Impulse withstand voltage		8000 V			
Protection		IP20	NEMA 1	Torque	0.4 Nm ... 0.6 Nm 3.5 lb.in ... 5.3 lb.in

The connecting capacity data for one Rigid: Solid/Stranded, or one Flexible conductor (when applicable) is a mandatory information required by IEC, UL and CSA standards (Copper conductors). All other data are provided as supplementary information only. For more details, please consult our CB, UL or CSA certificates and technical datasheet available on <http://www.TE.com>

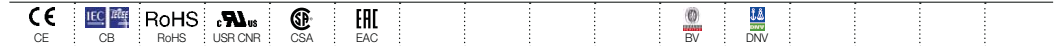

Accessories

Description	Color	Type	Part Number	Pkg qty	Weight (1 pce) g	
1 End stops 10 mm 0.394 in	Dark grey <input type="checkbox"/>	BAM4	1SNK900001R0000	50	14.00	
2 End sections 2 mm 0.079 in	Dark grey <input type="checkbox"/>	ES10-ST	1SNK508910R0000	20	3.5	
3 Lateral jumper bars	Black <input type="checkbox"/>	10 poles	PC8-10	1SNA163313R2400	10	14.00
		4/6 poles	PC8-R1	1SNA400711R0600	10	6.60
		4/8 poles	PC8-R2	1SNA400712R0700	10	7.80
		4/10 poles	PC8-R3	1SNA400713R0000	10	9.00
		3/4 poles	PC8-R4	1SNA400724R0300	10	4.50
		4/7 poles	PC8-R5	1SNA400842R0000	10	6.60
		2/3 poles	PC8-R6	1SNA400843R0000	10	6.60
		4/6 poles	PC8-R7	1SNA400849R0000	10	6.60
4/8 poles	PC8-R8	1SNA400850R0000	10	7.80		
4 Circuit separators 3 mm 0.118 in	Dark grey <input type="checkbox"/>	CS-R3	1SNK900107R0000	20	6.40	
5 Protecting cover kits	Dark grey <input type="checkbox"/>	KCO	1SNK900624R0000	1	47.80	
6 Protecting covers 1 m 39.4 in length	Transparent <input type="checkbox"/>	CO	1SNK900604R0000	1	300.00	
7 Short circuit bridges	Yellow <input type="checkbox"/>	2 poles	SC-JB8-2	1SNK900652R0000	25	2.00
		3 poles	SC-JB8-3	1SNK900653R0000	25	3.4
		4 poles	SC-JB8-4	1SNK900654R0000	25	4.7
8 Terminal block markers	White <input type="checkbox"/>	Blank marker	MG-CPM 13 41791	1SNB041791R0612	1680	0.27
		Blank card	MC812	1SNK160000R0000	22	10.00
			MC812PA	1SNK169999R0000	20	14.00
		Universal wire markers holder	Grey <input type="checkbox"/>	UMH	1SNK900611R0000	10

Complete list of accessories is indicated in the terminal block datasheet including end stops.

Some accessories such as jumper bars may modify the terminal block's ratings: Complete information available in the accessories section of the catalog.

Screw clamp terminal blocks

Description	Color	Type	Part Number	Pkg qty	Weight (1 pce) g
Feed-through Profile aligned with ZS10-ST...	Grey <input type="checkbox"/>	ZS10-R1	1SNK508011R0000	25	20.90
Ground Profile aligned with ZS10-ST...	Green-yellow <input type="checkbox"/>	ZS10-PE-R1	1SNK508151R0000	25	28.40



ZS10-R1



ZS10-PE-R1

Technical data valid for copper conductors only.

ZS10-R1 screw clamp terminal blocks

Feed-through - 8 mm 0.315 in spacing

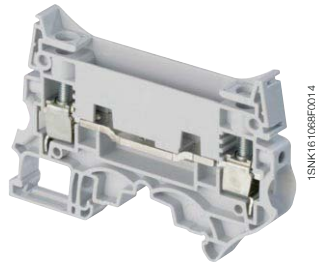

ZS10-R1

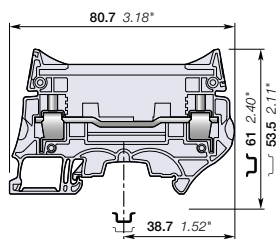

8 mm 0.315 in spacing

Description

- With the same profile as the ZS10-ST..., the feed-through ZS10-R1 allows you to fully implement the electrical drawing of your CT or PT circuits,
- Fully compatible with the ZS10-ST... accessories.

Ordering details

Description	Color	Type	Part Number	Pkg qty	Weight (1 pce) g
Feed-through Profile aligned with ZS10-ST..	Grey <input type="checkbox"/>	ZS10-R1	1SNK508011R0000	25	20.90

Main technical data

Connecting capacity		IEC	UL - CSA	Mounting instructions	
1 conductor per clamp	Rigid: Solid/Stranded	0.5 ... 10 mm ²	24 ... 6 AWG	Rail	TH 35-7.5, TH 35-15
	Flexible without ferrule	0.5 ... 10 mm ²		Wire stripping length	13 mm 0.512 in
	Flexible with non insulated ferrule	0.5 ... 10 mm ²	24 ... 8 AWG		
	Flexible with insulated ferrule	0.5 ... 6 mm ²	24 ... 10 AWG		
Gauge		A5-B5		Tool	Flat screwdriver Ø 3.5 mm Ø 0.138 in
2 conductors per clamp	Rigid: Solid/Stranded	0.5 ... 4 mm ²	20 ... 12 AWG		
	Flexible without ferrule	0.5 ... 4 mm ²	20 ... 12 AWG		
Flexible with twin ferrule		0.5 ... 4 mm ²	20 ... 12 AWG	Torque	1.3 Nm ± 0.3 11.5 lb.in ± 2.65
Rated current / Rated cross section		57 A / 10 mm ²	62 A / 6 AWG		
Rated short-time withstand current (1s)		1200 A			
Short Circuit Current Rating (with specific conditions)					
Rated voltage		630 V	300 V		
Impulse withstand voltage		8000 V			
Protection		IP20	NEMA 1		

The connecting capacity data for one Rigid: Solid/Stranded, or one Flexible conductor (when applicable) is a mandatory information required by IEC, UL and CSA standards (Copper conductors). All other data are provided as supplementary information only. For more details, please consult our CB, UL or CSA certificates and technical datasheet available on <http://www.TE.com>

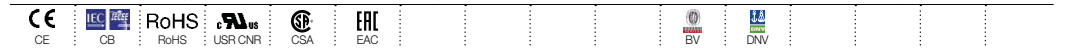

Accessories

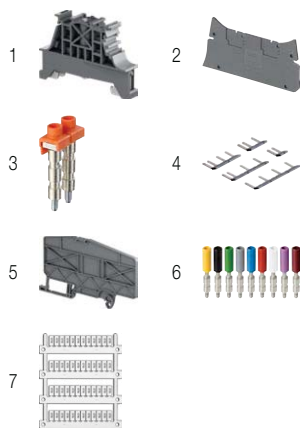

Description	Color	Type	Part Number	Pkg qty	Weight (1 pce) g	
1 End stops 10 mm 0.394 in	Dark grey <input type="checkbox"/>	BAM4	1SNK90001R0000	50	14.00	
2 End sections 2 mm 0.079 in	Dark grey <input type="checkbox"/>	ES10-ST	1SNK508910R0000	20	3.5	
3 Jumper bars	Orange <input type="checkbox"/>	2 poles 50 A (IEC)	JB8-2-R1	1SNK908902R0000	10	7.6
		3 poles 50 A (IEC)	JB8-3-R1	1SNK908903R0000	10	11.6
		4 poles 50 A (IEC)	JB8-4-R1	1SNK908904R0000	10	15.5
		5 poles 50 A (IEC)	JB8-5-R1	1SNK908905R0000	10	19.4
		10 poles 50 A (IEC)	JB8-10-R1	1SNK908910R0000	10	39.00
4 Lateral jumper bars	Black <input type="checkbox"/>	4/7 poles	PC8-R5	1SNA400842R0000	10	6.60
		2/3 poles	PC8-R6	1SNA400843R0000	10	6.60
		4/6 poles	PC8-R7	1SNA400849R0000	10	6.60
		4/8 poles	PC8-R8	1SNA400850R0000	10	7.80
5 Circuit separators 3 mm 0.118 in	Dark grey <input type="checkbox"/>	CS-R3	1SNK900107R0000	20	6.40	
6 Test sockets Test sockets DIA 4 mm 0.157 in	Yellow <input type="checkbox"/>	AJS9	1SNA179726R0200	25	3.60	
7 Terminal block markers	White <input type="checkbox"/>	Blank marker	MG-CPM 13 41791	1SNB041791R0612	1680	0.27
		Blank card	MC812	1SNK160000R0000	22	10.00
		Blank card	MC812PA	1SNK169999R0000	20	14.00
Universal wire markers holder	Grey <input type="checkbox"/>	UMH	1SNK900611R0000	10	0.20	

Complete list of accessories is indicated in the terminal block datasheet including end stops. Some accessories such as jumper bars may modify the terminal block's ratings: Complete information available in the accessories section of the catalog.

Technical data valid for copper conductors only.

ZS10-PE-R1 screw clamp terminal blocks

Ground - 8 mm 0.315 in spacing



ZS10-PE-R1

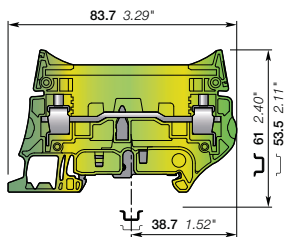

8 mm 0.315 in spacing

Description

- With the same profile as the ZS10-ST..., the ground ZS10-PE-R1 allows you to fully implement the electrical drawing of your CT or PT circuits,
- Fully compatible with the ZS10-ST... accessories,
- Short-circuit performances above the requirements of IEC 60947-7-2 terminal block standard,
- Secured snap on or remove from the rail.

Ordering details

Description	Color	Type	Part Number	Pkg qty	Weight (1 pce) g
Ground Profile aligned with ZS10-ST...	Green-yellow	ZS10-PE-R1	1SNK508151R0000	25	28.40

Main technical data

Connecting capacity	IEC	UL - CSA
1 conductor per clamp	Rigid: Solid/Stranded	0.5 ... 10 mm²
	Flexible without ferrule	0.5 ... 10 mm²
	Flexible with non insulated ferrule	0.5 ... 10 mm²
	Flexible with insulated ferrule	0.5 ... 6 mm²
	Gauge	A5-B5
Rated cross section	10 mm²	6 AWG
Rated short-time withstand current (1s)	1200 A	1596 A
Protection	IP20	NEMA 1

Mounting instructions

Rail		TH 35-7.5, TH 35-15
Wire stripping length		13 mm 0.512 in
Tool		Flat screwdriver Ø 3.5 mm Ø 0.138 in
Torque		1.3 Nm ± 0.3 11.5 lb.in ± 2.65

The connecting capacity data for one Rigid: Solid/Stranded, or one Flexible conductor (when applicable) is a mandatory information required by IEC, UL and CSA standards (Copper conductors). All other data are provided as supplementary information only. For more details, please consult our CB, UL or CSA certificates and technical datasheet available on <http://www.TE.com>

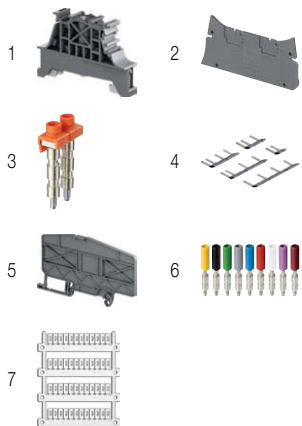
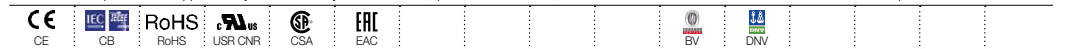

Accessories

Description	Color	Type	Part Number	Pkg qty	Weight (1 pce) g	
1 End stops 10 mm 0.394 in	Dark grey	BAM4	1SNK900001R0000	50	14.00	
2 End sections 2 mm 0.079 in	Dark grey	ES10-ST	1SNK508910R0000	20	3.5	
3 Jumper bars	Orange	2 poles 50 A (IEC)	JB8-2-R1	1SNK908902R0000	10	7.6
		3 poles 50 A (IEC)	JB8-3-R1	1SNK908903R0000	10	11.6
		4 poles 50 A (IEC)	JB8-4-R1	1SNK908904R0000	10	15.5
		5 poles 50 A (IEC)	JB8-5-R1	1SNK908905R0000	10	19.4
		10 poles 50 A (IEC)	JB8-10-R1	1SNK908910R0000	10	39.00
4 Lateral jumper bars	Black	4/7 poles	PC8-R5	1SNA400842R0000	10	6.60
		2/3 poles	PC8-R6	1SNA400843R0000	10	6.60
		4/6 poles	PC8-R7	1SNA400849R0000	10	6.60
		4/8 poles	PC8-R8	1SNA400850R0000	10	7.80
5 Circuit separators 3 mm 0.118 in	Dark grey	CS-R3	1SNK900107R0000	20	6.40	
6 Test sockets Test sockets DIA 4 mm 0.157 in	Yellow	AJS9	1SNA179726R0200	25	3.60	
7 Terminal block markers	White	Blank marker	MG-CPM 13 41791	1SNB041791R0612	1680	0.27
		Blank card	MC812	1SNK160000R0000	22	10.00
		Universal wire markers holder	MC812PA	1SNK169999R0000	20	14.00
	Grey	UMH	1SNK900611R0000	10	0.20	

Complete list of accessories is indicated in the terminal block datasheet including end stops. Some accessories such as jumper bars may modify the terminal block's ratings: Complete information available in the accessories section of the catalog.

Technical data valid for copper conductors only.



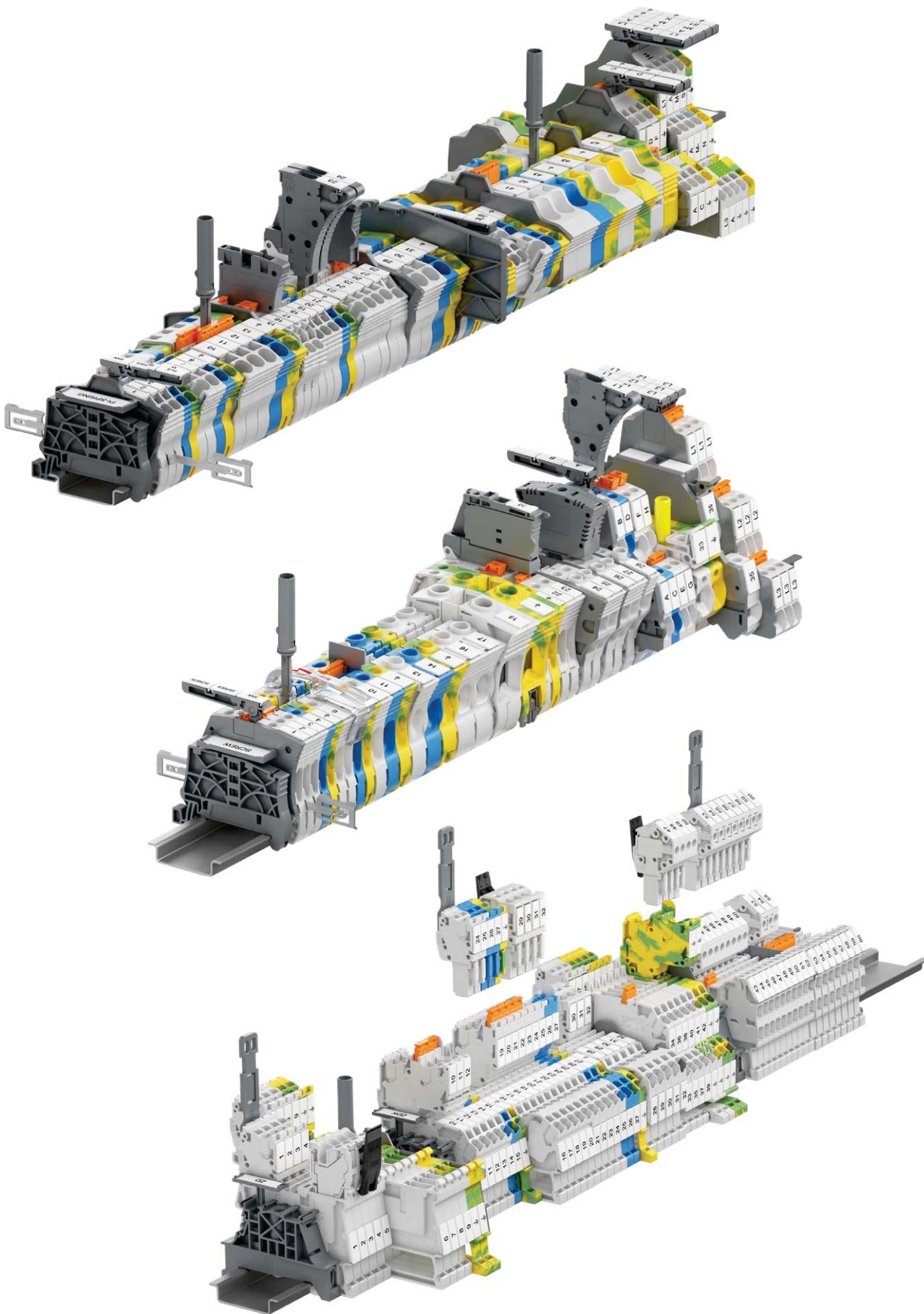

Railway applications, terminal blocks

Accessories

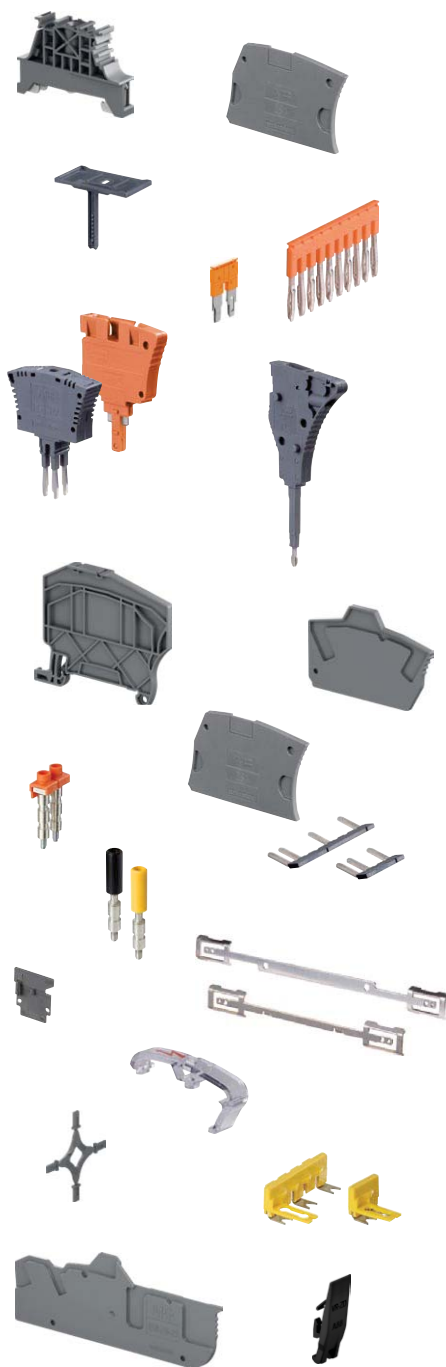

Common terminal block accessories

Mounting rail	PR	310-313
---------------	----	---------

SNK series, common terminal block accessories

Screw end stops	BAM4, BAZH1	314
Screwless end stops	BAZ1	315
Label holders	LH, LH-R1	316
	LH-J	317
Screwless jumper bars	JB5	318
	JB6	319
	JB8	320
	JB10	321
	JB12	322
Cross spacing jumpers	JB85-3	323
Test adapters	TP2, TP4	324
Test connectors	TC5	325
Component plugs	PG5-R2	326
	PG5, PG5-R1	327
Screwdrivers	TO	328
Crimping tools	PS	328

PI-Spring terminal block accessories

End sections	EK	329-331
Circuit separators	CS-R2, CS-R3	332-333
Shield connectors	SHBP, SHB	334

Screw clamp terminal block accessories

End sections	ES	335-336
Screw jumper bars	JB8	337
	JB16, JB22	338
	JB26	339
	BJMI31, BJMI36	340
Lateral jumper bars	PC8, PC81	341
Circuit separator	CS, CS-R1	342
Shield connectors	SHBS, SHB	343
Protecting covers	PL	344
	CO, KCO	345
Short circuit bridges	SC-JB8	346
Test sockets	AJS9	347

Pluggable terminal block accessories

End sections	EDK, EDS	348-349
Coding pegs	COP	350
Locking devices	VR	350

PR mounting rail

Common terminal block accessories



1SNK60072F0000

PR30

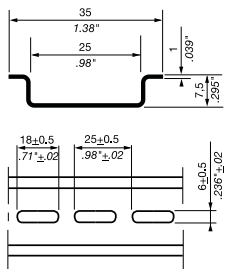

2000 mm 78.74 in spacing

Description

- Pre-punched symmetrical mounting rail,
- The slotted holes ease the mounting and allow to use existing and/or numerous fixings,
- Particularly well designed for fixing onto back-plates and for terminal assemblies of small dimensions.

Ordering details

Description	Color	Type	Part Number	Pkg meter	Weight (1 pce)
Prepunched rail		PR30	1SNA173220R0500	2	328.00 g

Please note that for all rails: 1 part number equal 1 meter (39 in). Packing of 2 meters (78 in) minimum. Check that your order quantity is a multiple of 2.

Main technical data

Material	Zinc plating and passivation steel				
Rail	TH 35-7.5				
	IEC	UL - CSA			
Equivalent E-Cu cross section					
All the main technical data provided are "manufacturer" values.					
RoHS	RoHS				

Mounting instructions

- In order to guarantee the performances and security of your installation, please ensure the rail and its fixings can withstand the static and dynamic loads of the components mounted on it;
- To prevent the rail from flexing (1 mm 0.039 in rail thickness only), fixing is recommended every 250 mm 9.84 in;
- To prevent any issues during mounting, screw heads used for rail fixing should not protrude from the rail (7,5 mm 0.295 in rail height only).

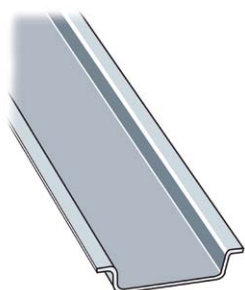

1SNK60073F0000

PR3.Z2

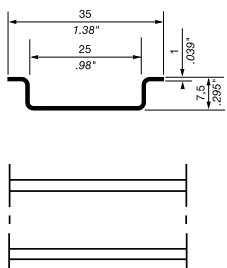

2000 mm 78.74 in spacing

Description

- Symmetrical mounting rail complying with IEC60715,
- Particularly well designed for fixing onto back-plates and for terminal assemblies of small dimensions.

Ordering details

Description	Color	Type	Part Number	Pkg meter	Weight (1 pce)
		PR3.Z2	1SNA174300R1700	2	718.00 g

Please note that for all rails: 1 part number equal 1 meter (39 in). Packing of 2 meters (78 in) minimum. Check that your order quantity is a multiple of 2.

Main technical data

Material	Zinc plating and passivation steel				
Rail	TH 35-7.5				
	IEC	UL - CSA			
Equivalent E-Cu cross section	16 mm ²				
All the main technical data provided are "manufacturer" values.					
RoHS	RoHS				

Mounting instructions

- In order to guarantee the performances and security of your installation, please ensure the rail and its fixings can withstand the static and dynamic loads of the components mounted on it;
- To prevent the rail from flexing (1 mm 0.039 in rail thickness only), fixing is recommended every 250 mm 9.84 in;
- To prevent any issues during mounting, screw heads used for rail fixing should not protrude from the rail (7,5 mm 0.295 in rail height only).

Technical data valid for copper conductors only.

PR mounting rail

Common terminal block accessories

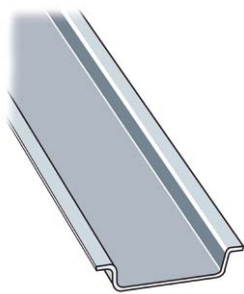

1SNA600073F0000

PR3.G2

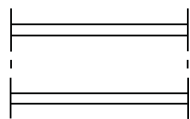
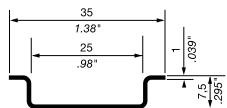

2000 mm 78.74 in spacing

Description

- Symmetrical mounting rail made of galvanised steel, complying with IEC60715,
- Particularly well designed for fixing onto back-plates and for terminal assemblies of small dimensions.

Ordering details

Description	Color	Type	Part Number	Pkg meter	Weight (1 pce) g
		PR3.G2	1SNA164800R0300	2	718.00

Please note that for all rails: 1 part number equal 1 meter (39 in). Packing of 2 meters (78 in) minimum. Check that your order quantity is a multiple of 2.

Main technical data

Material	Galvanised steel		
Rail	TH 35-7.5		
	IEC	UL - CSA	
Equivalent E-Cu cross section	16 mm ²		

All the main technical data provided are "manufacturer" values.

RoHS																			
RoHS																			

Mounting instructions

- In order to guarantee the performances and security of your installation, please ensure the rail and its fixings can withstand the static and dynamic loads of the components mounted on it;
- To prevent the rail from flexing (1 mm 0.039 in rail thickness only), fixing is recommended every 250 mm 9.84 in;
- To prevent any issues during mounting, screw heads used for rail fixing should not protrude from the rail (7,5 mm 0.295 in rail height only).



1SNA600074F0000

PR50

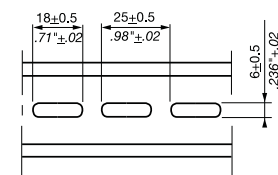
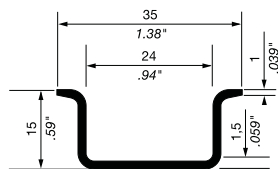

2000 mm 78.74 in spacing

Description

- Pre-punched symmetrical mounting rail,
- The slotted holes ease the mounting and allow to use existing and/or numerous fixings.

Ordering details

Description	Color	Type	Part Number	Pkg meter	Weight (1 pce) g
Prepunched rail		PR50	1SNA178529R0400	2	1288.00

Please note that for all rails: 1 part number equal 1 meter (39 in). Packing of 2 meters (78 in) minimum. Check that your order quantity is a multiple of 2.

Main technical data

Material	Zinc plating and passivation steel		
Rail	TH 35-15		
	IEC	UL - CSA	
Equivalent E-Cu cross section			

All the main technical data provided are "manufacturer" values.

RoHS																			
RoHS																			

Mounting instructions

- In order to guarantee the performances and security of your installation, please ensure the rail and its fixings can withstand the static and dynamic loads of the components mounted on it;
- To prevent the rail from flexing, fixing is recommended every 700 mm 27.6 in;
- In order to increase the accessibility of your terminal assembly, we recommend the use of our rail offset brackets EM45 (order code 1SNA008521R2600) for a 45° orientation of the rail.

Technical data valid for copper conductors only.

PR mounting rail

Common terminal block accessories

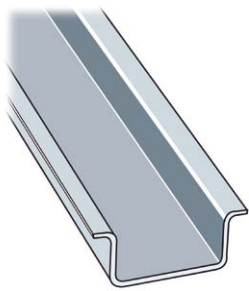

1SNA00075F0000

PR5

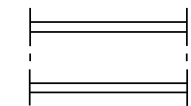
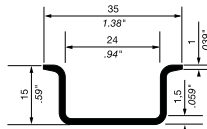

2000 mm 78.74 in spacing

Description

- Symmetrical mounting rail.

Ordering details

Description	Color	Type	Part Number	Pkg meter	Weight (1 pce) g
		PR5	1SNA168700R2200	2	1200.00

Please note that for all rails: 1 part number equal 1 meter (39 in). Packing of 2 meters (78 in) minimum. Check that your order quantity is a multiple of 2.

Main technical data

Material	Zinc plating and passivation steel
Rail	TH 35-15

	IEC	UL - CSA
--	-----	----------

Equivalent E-Cu cross section

All the main technical data provided are "manufacturer" values.

RoHS									
RoHS									

Mounting instructions

- In order to guarantee the performances and security of your installation, please ensure the rail and its fixings can withstand the static and dynamic loads of the components mounted on it;
- To prevent the rail from flexing, fixing is recommended every 700 mm 27.6 in;
- In order to increase the accessibility of your terminal assembly, we recommend the use of our rail offset brackets EM45 (order code 1SNA008521R2600) for a 45° orientation of the rail.

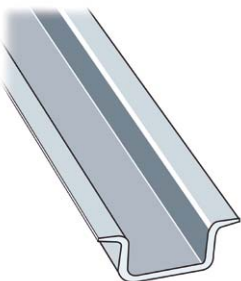

1SNA00076F0000

PR4

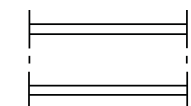
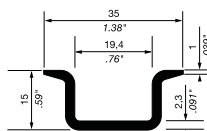

2000 mm 78.74 in spacing

Description

- Symmetrical mounting rail complying with IEC60715,
- The rigidity of the rail is maximised by the 2.3 mm 0.090 in thickness of the rail, and by its solid, non slotted construction,
- PR4 TH 35-15 is the most rigid mounting rail solution and it can support

Ordering details

Description	Color	Type	Part Number	Pkg meter	Weight (1 pce) g
Recommended for SNK ground terminal blocks up to 35 mm ² 2 AWG		PR4	1SNA168500R1200	2	915.00

Please note that for all rails: 1 part number equal 1 meter (39 in). Packing of 2 meters (78 in) minimum. Check that your order quantity is a multiple of 2.

Main technical data

Material	Zinc plating and passivation steel
Rail	TH 35-15

	IEC	UL - CSA
--	-----	----------

Equivalent E-Cu cross section

All the main technical data provided are "manufacturer" values.

RoHS									
RoHS									

Mounting instructions

- In order to guarantee the performances and security of your installation, please ensure the rail and its fixings can withstand the static and dynamic loads of the components mounted on it;
- To prevent the rail from flexing, fixing is recommended every 700 mm 27.6 in;
- In order to increase the accessibility of your terminal assembly, we recommend the use of our rail offset brackets EM45 (order code 1SNA008521R2600) for a 45° orientation of the rail.

Technical data valid for copper conductors only.

1SNA160041S0201

PR mounting rail

Common terminal block accessories



1SNC16041FR014

PRH2R

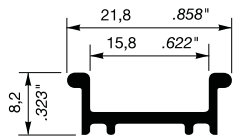

2000 mm 78.74 in spacing

Description

- Symmetrical mounting rail type 2 reinforced,
- Particularly well adapted for railway applications.

Ordering details

Description	Color	Type	Part Numbers	Pkg pce	Weight (1 pce) g
		PRH2R	1SNA163350R1500	2	278.00

Please note that for all rails: 1 part number equal 1 meter (39 in). Packing of 2 meters (78 in) minimum.
Check that your order quantity is a multiple of 2.

Main technical data

Material	Aluminium alloy
Rail	Type 2

	IEC	UL - CSA
--	-----	----------

Equivalent E-Cu cross section

All the main technical data provided are "manufacturer" values.

RoHS																			
RoHS																			

Mounting instructions

- In order to guarantee the performances and security of your installation, please ensure the rail and its fixings can withstand the static and dynamic loads of the components mounted on it,
- To prevent the rail from flexing, fixing is recommended every 250 mm 9.84 in,
- To prevent any issues during mounting, screw heads used for rail fixing should not protrude from the rail.

Screw end stops

Common terminal block accessories

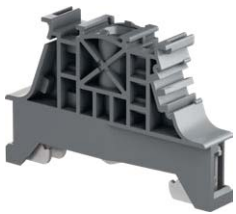

1SNK16033V0014

BAM4

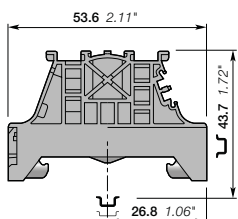

10 mm 0.394 in spacing

Mounting instructions



BAM4 screw end stops

Description

- Give efficient support to the SNK terminal blocks assemblies thanks to the BAM4 double gripping rail contact,
- Ease the assemblies identification with the BAM4 marking location compatible with all SNK markers and labels.

Ordering details

Description	Color	Type	Part Number	Pkg qty	Weight (1 pce) g
10 mm 0.394 in spacing	Dark grey <input checked="" type="checkbox"/>	BAM4	1SNK900001R0000	50	14.00

Main technical data

Material specifications	Insulating material	Polyamide	
	Flammability	V0	
Ambient temperature min/max	NF F 16 101	I2F2	
	Service IEC 60068-2-1	-55 ... +110 °C	-67 ... +230 °F
	Storage	-55 ... +110 °C	-67 ... +230 °F
	Installing	-5 ... +40 °C	+23 ... +104 °F

Mounting instructions

Rail		TH 35-7.5, TH 35-15
Tool		Flat screwdriver Ø 5.5 mm Ø 0.217 in
Torque		0.9 Nm ± 0.1 7.08 lb.in ± 0.88

All the main technical data provided are "manufacturer" values

RoHS
RoHS

Accessories

Description	Color	Type	Part Number	Pkg qty	Weight (1 pce) g
Terminal block markers compatible with MG3	White <input type="checkbox"/>	MG-CPM 13 41791	1SNB041791R0612	1680	0.27
Blank card	In polycarbonate	MC812	1SNK160000R0000	22	10.00
		MC812PA	1SNK169999R0000	20	14.00
Label holder	Dark grey <input checked="" type="checkbox"/>	LH	1SNK900605R0000	50	0.60
		LH-R1	1SNK900607R0000	50	1.10
Universal wire markers holder	Grey <input type="checkbox"/>	UMH	1SNK900611R0000	10	0.20

BAZH1 screw end stops

Description

- Give efficient support to the SNK double deck or power terminal blocks assemblies thanks to the BAZH1 double gripping rail contact,
- Ease the assemblies identification with label holders.

Ordering details

Description	Color	Type	Part Number	Pkg qty	Weight (1 pce) g
10 mm 0.394 in spacing	Dark grey <input checked="" type="checkbox"/>	BAZH1	1SNK900102R0000	20	24.00

Main technical data

Material specifications	Insulating material	Polyamide	
	Flammability	V0	
Ambient temperature min/max	NF F 16 101	I2F2	
	Service IEC 60068-2-1	-55 ... +110 °C	-67 ... +230 °F
	Storage	-55 ... +110 °C	-67 ... +230 °F
	Installing	-5 ... +40 °C	+23 ... +104 °F

Mounting instructions

Rail		TH 35-7.5
Tool		Flat screwdriver Ø 5.5 mm Ø 0.217 in
Torque		1.3 Nm ± 0.1 11.4 lb.in ± 0.88

All the main technical data provided are "manufacturer" values

RoHS
RoHS

Accessories

Description	Color	Type	Part Number	Pkg qty	Weight (1 pce) g
Terminal block markers compatible with MG3	White <input type="checkbox"/>	MG-CPM 13 41791	1SNB041791R0612	1680	0.27
Blank card	In polycarbonate	MC812	1SNK160000R0000	22	10.00
		MC812PA	1SNK169999R0000	20	14.00
Label holder	Dark grey <input checked="" type="checkbox"/>	LH	1SNK900605R0000	50	0.60
		LH-R1	1SNK900607R0000	50	1.10
Universal wire markers holder	Grey <input type="checkbox"/>	UMH	1SNK900611R0000	10	0.20

Technical data valid for copper conductors only.



1SNK16009R0014

BAZH1

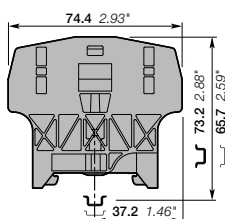

10 mm 0.394 in spacing

Screwless end stops

Common terminal block accessories



BAZ1

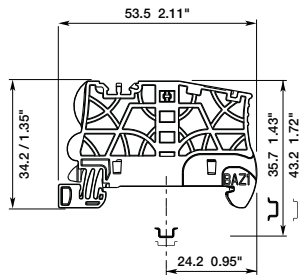

5.2 mm 0.205 in spacing

BAZ1 screwless end stops

Description

- Reduce the size of your terminal block assemblies with the screwless reduced spacing BAZ1 end stop,
- Ease the assemblies identification with various markers and label holders.

Ordering details

Description	Color	Type	Part Number	Pkg qty	Weight (1 pce) g
5.2 mm 0.205 in spacing	Dark grey <input checked="" type="checkbox"/>	BAZ1	1SNK900002R0000	50	5.30

Main technical data

Material specifications		Insulating material		Polyamide		Mounting instructions	
Flammability		NF F 16 101		V0		Rail	
Ambient temperature min/max		Service IEC 60068-2-1		-55 ... +110 °C		TH 35-7.5	
		Storage		-67 ... +230 °F			
		Installing		-5 ... +40 °C			
				+23 ... +104 °F			

All the main technical data provided are "manufacturer" values

RoHS	
RoHS	

Accessories

Description	Color	Type	Part Number	Pkg qty	Weight (1 pce) g
Terminal block markers compatible with MG3	White <input type="checkbox"/>	MG-CPM 13 41790	1SNB041790R0512	1960	0.23
Blank card compatible with HTP500		MC512	1SNK140000R0000	22	9.00
Blank card compatible with AMS600		MC512PA	1SNK149999R0000	20	10.00
Label holder 10 mm 0.394 in width	Dark grey <input checked="" type="checkbox"/>	LH	1SNK900605R0000	50	0.60
Label holder 19.5 mm 0.768 in width		LH-R1	1SNK900607R0000	50	1.10
Universal wire markers holder 5.2 mm 0.205 in spacing	Grey <input type="checkbox"/>	UMH	1SNK900611R0000	10	0.20

Technical data valid for copper conductors only.

Label holder

Common terminal block accessories



1SNK1603340014

LH
10 mm 0.394 in spacing

LH label holder

Description

- Easily identify your terminal blocks assembly with white or yellow labels,
- Adjustable in height for best visibility,
- Compatible with all SNK end stops.

Ordering details

Description	Color	Type	Part Number	Pkg qty	Weight (1 pce) g
10 mm 0.394 in width	Dark grey <input checked="" type="checkbox"/>	LH	1SNK900605R0000	50	0.60

Main technical data

Material specifications	Insulating material	Polyamide			
	Flammability	V0			
	NF F 16 101	I2F2			
Ambient temperature min/max	Service IEC 60068-2-1	-55 ... +110 °C	-67 ... +230 °F		
	Storage	-55 ... +110 °C	-67 ... +230 °F		
	Installing	-5 ... +40 °C	+23 ... +104 °F		

All the main technical data provided are "manufacturer" values

RoHS
RoHS

Accessories

Description	Color	Type	Part Number	Pkg qty	Weight (1 pce) g
Self-adhesive precut blank label compatible with HTP500	White <input type="checkbox"/>	MCLH	1SNK900630R0000	25	10.00
Self-adhesive precut blank label compatible with HTP500	White <input type="checkbox"/>	RCPEAD-TT	1SNA235158R0100	25	9.80
	Yellow <input type="checkbox"/>	RCPEAD-TT-YL	1SNA235159R0200	25	12.10
Pre-printed cover marker Protection for RCPEAD markers	Transparent <input checked="" type="checkbox"/>	EPR2	1SNA399726R0700	10	4.00
Precut blank label compatible with MG3	White <input type="checkbox"/>	MG-TAR 45490	1SNB045490R8530	1650	0.371
Self-adhesive precut blank label compatible with MG3	Yellow <input type="checkbox"/>	MG-TAA 49448	1SNB049448R8530	825	0.55
	White <input type="checkbox"/>	MG-TAA 49498	1SNB049498R8530	825	0.55
Self-adhesive precut blank label compatible with HTP500	Yellow <input type="checkbox"/>	MCLH-YL	1SNK900633R0000	25	10.00



1SNK160350014

LH
19.5 mm 0.768 in spacing

LH-R1 label holder

Description

- Easily identify your terminal blocks assembly with white or yellow labels,
- Adjustable in height for best visibility,
- Compatible with all SNK end stops.

Ordering details

Description	Color	Type	Part Number	Pkg qty	Weight (1 pce) g
19.5 mm 0.768 in width	Dark grey <input checked="" type="checkbox"/>	LH-R1	1SNK900607R0000	50	1.10

Main technical data

Material specifications	Insulating material	Polyamide			
	Flammability	V0			
	NF F 16 101	I2F2			
Ambient temperature min/max	Service IEC 60068-2-1	-55 ... +110 °C	-67 ... +230 °F		
	Storage	-55 ... +110 °C	-67 ... +230 °F		
	Installing	-5 ... +40 °C	+23 ... +104 °F		

All the main technical data provided are "manufacturer" values

RoHS
RoHS

Accessories

Description	Color	Type	Part Number	Pkg qty	Weight (1 pce) g
Self-adhesive precut blank label compatible with HTP500	White <input type="checkbox"/>	MCLH-R1	1SNK900631R0000	25	10.00
Precut blank label Protection for RCPEB markers	White <input type="checkbox"/>	RCPEB	1SNA178430R0500	1	
	Transparent <input checked="" type="checkbox"/>	EPR1	1SNA178431R2200	1	0.05
Self-adhesive precut blank label compatible with HTP500	White <input type="checkbox"/>	PIB2-TT	1SNA235155R2600	25	9.70
	Yellow <input type="checkbox"/>	PIB2-TT-YL	1SNA235157R2000	25	9.40
Precut blank label compatible with MG3	White <input type="checkbox"/>	MG-TAR 45194	1SNB045194R1735	900	0.62
Self-adhesive precut blank label	Yellow <input type="checkbox"/>	MG-TAA 49148	1SNB049148R1735	450	0.91
	White <input type="checkbox"/>	MG-TAA 49198	1SNB049198R1735	450	0.91
Self-adhesive precut blank label compatible with HTP500	Yellow <input type="checkbox"/>	MCLH-R1-YL	1SNK900634R0000	25	10.00

Technical data valid for copper conductors only.

Mounting instructions

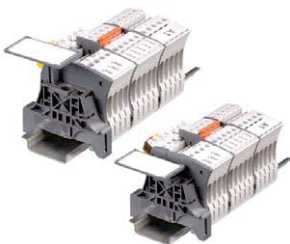

Label holder

Common terminal block accessories



1SNK16096S2014

LH

4.8 mm 0.189 in spacing

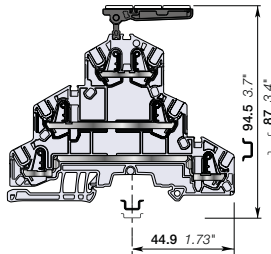

LH-J label holder

Description

Easily identify your block with three standard 5.2 mm 0.205 in spacing SNK markers. It fits in the jumper channel of the SNK terminal blocks.

Ordering details

Description	Color	Type	Part Number	Pkg qty	Weight (1 pce) g
Rotating label holder with three SNK markers housings - 4.8 mm 0.189 in spacing	Dark grey <input checked="" type="checkbox"/>	LH-J	1SNK900606R0000	100	0.73

Main technical data

Material specifications	Insulating material	Polyamide			
	Flammability	V0			
	NF F 16 101	I2F2			
Ambient temperature min/max	Service IEC 60068-2-1	-55 ... +110 °C	-67 ... +230 °F		
	Storage	-55 ... +110 °C	-67 ... +230 °F		
	Installing	-5 ... +40 °C	+23 ... +104 °F		

All the main technical data provided are "manufacturer" values

	RoHS				
	RoHS				

Accessories

Description	Color	Type	Part Number	Pkg qty	Weight (1 pce) g
Blank marker compatible with MG3	White <input type="checkbox"/>	MG-CPM 13 41790	1SNB041790R0512	1960	0.23
Blank card compatible with HTP500	White <input type="checkbox"/>	MC512	1SNK140000R0000	22	9.00
	White <input type="checkbox"/>	MC512PA	1SNK149999R0000	20	10.00
Universal wire markers holder 5.2 mm 0.205 in spacing	Grey <input type="checkbox"/>	UMH	1SNK900611R0000	10	0.20

Technical data valid for copper conductors only.

JB5 screwless jumper bars

Common terminal block accessories



1SNK160143P0014

JB5
5.2 mm 0.205 in spacing

Description

Facilitate & secure your jumper bar assembly process:

- Screwless mounting,
- Pre-cut poles for alternated jumpering between terminal blocks,
- Insulated,
- Positive locking,
- Perfectly adapted to low level electrical contact (20mA, 50mV).

Ordering details

Description		Color	Type	Part Number	Pkg qty	Weight (1 pce) g
5.2 mm 0.205 in spacing	2 poles	Orange	JB5-2	1SNK905302R0000	50	1.30
	3 poles		JB5-3	1SNK905303R0000	50	2.00
	4 poles		JB5-4	1SNK905304R0000	50	2.70
	5 poles		JB5-5	1SNK905305R0000	50	3.50
	10 poles		JB5-10	1SNK905310R0000	30	7.10
	50 poles		JB5-50	1SNK905350R0000	10	36.00

Main technical data

Material specifications	Insulating material	Polyamide		
	Flammability	V0		
	NF F 16 101	I2F3		
Ambient temperature min/max	Service IEC 60068-2-1	-55 ... +110 °C	-67 ... +230 °F	
	Storage	-55 ... +110 °C	-67 ... +230 °F	
	Installing	-5 ... +40 °C	+23 ... +104 °F	
		IEC	UL - CSA	Ex e
Rated current		32 A	30 A	
Rated voltage	1 - Standard use	1000 V	600 V	Please consult us
	2 - Cut extremities	800 V	300 V	
	3 - Cut poles	630 V	300 V	
	4 - Alternated poles	400 V	150 V	
	5 - Alternated poles with cut extremities	400 V	150 V	
Impulse withstand voltage		8000 V		
Protection		IP20	NEMA 1	
All the main technical data are indicative "manufacturer" values.				
	RoHS			
	RoHS			

Mounting instructions

1 - Standard use

2 - Cut extremities
For voltage rating > 50 V and Uimp > 2.5 KV, the below accessories must be installed on the cut side of the jumper to guarantee IP20 and voltage rating:

ZS...	Feed-through	CS circuit separator
ZK...	Double deck / triple deck	ES... end section
	All functions	EK... end section

Ensure a good straight cut by positioning the cutting tool on the vertical snicks of the insulated part of the jumper.

15 poles max. recommended for convenient mounting.

3 - Cut poles

4 - Alternated poles

5 - Alternated poles with cut extremities
When using cut jumpers, cut extremities should be placed oppositely to allow end sections / circuit separators placement at each cut extremities.

For all other applications, please consult us.

Technical data valid for copper conductors only.

1SNK160027S0201

JB6 screwless jumper bars

Common terminal block accessories



1SNK160143F0014

JB6
6 mm 0.236 in spacing

Description

Facilitate & secure your jumper bar assembly process:

- Screwless mounting,
- Pre-cut poles for alternated jumpering between terminal blocks,
- Insulated,
- Positive locking,
- Perfectly adapted to low level electrical contact (20mA, 50mV).

Ordering details

Description		Color	Type	Part Number	Pkg qty	Weight (1 pce) g
6 mm 0.236 in spacing	2 poles	Orange	JB6-2	1SNK906302R0000	50	1.30
	3 poles		JB6-3	1SNK906303R0000	50	2.10
	4 poles		JB6-4	1SNK906304R0000	50	2.90
	5 poles		JB6-5	1SNK906305R0000	50	3.60
	10 poles		JB6-10	1SNK906310R0000	20	7.40
	50 poles		JB6-50	1SNK906350R0000	10	38.10

Main technical data

Material specifications	Insulating material	Polyamide		
	Flammability	V0		
Ambient temperature min/max	NF F 16 101	I2F3		
	Service IEC 60068-2-1	-55 ... +110 °C	-67 ... +230 °F	
	Storage	-55 ... +110 °C	-67 ... +230 °F	
	Installing	-5 ... +40 °C	+23 ... +104 °F	
		IEC	UL - CSA	Ex e
Rated current		41 A	30 A	
Rated voltage	1 - Standard use	1000 V	600 V	Please consult our dedicated certificates
	2 - Cut extremities	800 V	300 V	
	3 - Cut poles	630 V	300 V	
	4 - Alternated poles	400 V	150 V	
	5 - Alternated poles with cut extremities	400 V	150 V	
Impulse withstand voltage		8000 V		
Protection		IP20	NEMA 1	
All the main technical data are indicative "manufacturer" values.				
	RoHS			
	RoHS			

Mounting instructions

1 - Standard use

2 - Cut extremities
For voltage rating > 50 V and Uimp > 2.5 KV, the below accessories must be installed on the cut side of the jumper to guarantee IP20 and voltage rating:

ZS...	Feed-through	CS circuit separator
ZK...	Double deck / triple deck	ES... end section
	All functions	EK... end section

Ensure a good straight cut by positioning the cutting tool on the vertical snicks of the insulated part of the jumper.

15 poles max. recommended for convenient mounting.

3 - Cut poles

4 - Alternated poles

5 - Alternated poles with cut extremities
When using cut jumpers, cut extremities should be placed oppositely to allow end sections / circuit separators placement at each cut extremities.

For all other applications, please consult us.

Technical data valid for copper conductors only.

1SNK160029S0201

JB8 screwless jumper bars

Common terminal block accessories



1SNK160146F0014

JB8
8 mm 0.315 in spacing

Description

Facilitate & secure your jumper bar assembly process:

- Screwless mounting,
- Pre-cut poles for alternated jumpering between terminal blocks,
- Insulated,
- Positive locking,
- Perfectly adapted to low level electrical contact (20mA, 50mV).

Ordering details

Description	Color	Type	Part Number	Pkg qty	Weight (1 pce)
8 mm 0.315 in spacing	Orange	JB8-2	1SNK908302R0000	50	2.70
		JB8-3	1SNK908303R0000	50	4.10
		JB8-4	1SNK908304R0000	50	5.60
		JB8-5	1SNK908305R0000	40	7.00
		JB8-10	1SNK908310R0000	20	14.20

Main technical data

Material specifications	Insulating material	Polyamide		
	Flammability	V0		
	NF F 16 101	I2F3		
Ambient temperature min/max	Service IEC 60068-2-1	-55 ... +110 °C	-67 ... +230 °F	
	Storage	-55 ... +110 °C	-67 ... +230 °F	
	Installing	-5 ... +40 °C	+23 ... +104 °F	
Rated current		IEC	UL - CSA	Ex e
		57 A	42 A	
Rated voltage	1 - Standard use	1000 V	600 V	693 V
	2 - Cut extremities	800 V	300 V	440 V
	3 - Cut poles	630 V	300 V	440 V
	4 - Alternated poles	630 V	150 V	352 V
	5 - Alternated poles with cut extremities	630 V	150 V	352 V
Impulse withstand voltage		6000 V		
Protection		IP20	NEMA 1	
All the main technical data are indicative "manufacturer" values.				
	RoHS			
	RoHS			

Mounting instructions

1 - Standard use

2 - Cut extremities
For voltage rating > 50 V and Uimp > 2.5 KV, the below accessories must be installed on the cut side of the jumper to guarantee IP20 and voltage rating:

ZS...	Feed-through	CS circuit separator
	Double deck / triple deck	ES... end section
ZK...	All functions	EK... end section

Ensure a good straight cut by positioning the cutting tool on the vertical snicks of the insulated part of the jumper.

3 - Cut poles

4 - Alternated poles

5 - Alternated poles with cut extremities
When using cut jumpers, cut extremities should be placed oppositely to allow end sections / circuit separators placement at each cut extremities.

For all other applications, please consult us.

Technical data valid for copper conductors only.

JB10 screwless jumper bars

Common terminal block accessories



1SNK160146P0014

JB10
10 mm 0.394 in spacing

Description

Facilitate & secure your jumper bar assembly process:

- Screwless mounting,
- Pre-cut poles for alternated jumpering between terminal blocks,
- Insulated,
- Positive locking,
- Perfectly adapted to low level electrical contact (20mA, 50mV).

Ordering details

Description		Color	Type	Part Number	Pkg qty	Weight (1 pce) g
10 mm 0.394 in spacing	2 poles	Orange	JB10-2	1SNK910302R0000	50	4.60
	3 poles		JB10-3	1SNK910303R0000	50	7.10
	4 poles		JB10-4	1SNK910304R0000	40	9.40
	5 poles		JB10-5	1SNK910305R0000	30	12.00
	10 poles		JB10-10	1SNK910310R0000	20	24.00

Main technical data

Material specifications	Insulating material	Polyamide		
	Flammability	V0		
	NF F 16 101	I2F3		
Ambient temperature min/max	Service IEC 60068-2-1	-55 ... +110 °C	-67 ... +230 °F	
	Storage	-55 ... +110 °C	-67 ... +230 °F	
	Installing	-5 ... +40 °C	+23 ... +104 °F	
		IEC	UL - CSA	Ex e
Rated current		76 A	67 A	
Rated voltage	1 - Standard use	1000 V	600 V	693 V
	2 - Cut extremities	800 V	300 V	440 V
	3 - Cut poles	630 V	300 V	440 V
	4 - Alternated poles	400 V	150 V	275 V
	5 - Alternated poles with cut extremities	250 V	150 V	176 V
Impulse withstand voltage		6000 V		
Protection		IP20	NEMA 1	
All the main technical data are indicative "manufacturer" values.				
	RoHS			
	RoHS			

Mounting instructions

①

②

③

④

⑤

1 - Standard use

2 - Cut extremities
For voltage rating > 50 V and Uimp > 2.5 KV, the below accessories must be installed on the cut side of the jumper to guarantee IP20 and voltage rating:

ZS...	Feed-through	CS circuit separator
ZK...	Double deck / triple deck	ES... end section
	All functions	EK... end section

Ensure a good straight cut by positioning the cutting tool on the vertical snicks of the insulated part of the jumper.

3 - Cut poles

4 - Alternated poles

5 - Alternated poles with cut extremities
When using cut jumpers, cut extremities should be placed oppositely to allow end sections / circuit separators placement at each cut extremities.

For all other applications, please consult us.

Technical data valid for copper conductors only.

JB12 screwless jumper bars

Common terminal block accessories



1SNK160230V0014

JB12
12 mm 0.472 in spacing

Description

Facilitate & secure your jumper bar assembly process:

- Screwless mounting,
- Pre-cut poles for alternated jumpering between terminal blocks,
- Insulated,
- Positive locking,
- Perfectly adapted to low level electrical contact (20mA, 50mV).

Ordering details

Description		Color	Type	Part Number	Pkg qty	Weight (1 pce)
12 mm 0.472 in spacing	2 poles	Orange	JB12-2	1SNK912302R0000	50	4.90
	3 poles		JB12-3	1SNK912303R0000	50	7.60
	5 poles		JB12-5	1SNK912305R0000	20	12.90

Main technical data

Material specifications	Insulating material	Polyamide		
	Flammability	V0		
	NF F 16 101	I2F2		
Ambient temperature min/max	Service IEC 60068-2-1	-55 ... +110 °C	-67 ... +230 °F	
	Storage	-55 ... +110 °C	-67 ... +230 °F	
	Installing	-5 ... +40 °C	+23 ... +104 °F	
Rated current		IEC	UL - CSA	Ex e
Rated voltage		76 A	67 A	
1 - Standard use		1000 V	600 V	693 V
2 - Cut extremities		800 V	300 V	440 V
3 - Cut poles		630 V	300 V	440 V
4 - Alternated poles		320 V	150 V	220 V
5 - Alternated poles with cut extremities		250 V	150 V	176 V
Impulse withstand voltage		6000 V		
Protection		IP20	NEMA 1	
All the main technical data are indicative "manufacturer" values.				
RoHS		RoHS		

Mounting instructions

1 - Standard use

2 - Cut extremities
For voltage rating > 50 V and Uimp > 2.5 KV, the below accessories must be installed on the cut side of the jumper to guarantee IP20 and voltage rating:

ZS...	Feed-through	CS circuit separator
ZK...	Double deck / triple deck	ES... end section
	All functions	EK... end section

Ensure a good straight cut by positioning the cutting tool on the vertical snicks of the insulated part of the jumper.

3 - Cut poles

4 - Alternated poles

5 - Alternated poles with cut extremities
When using cut jumpers, cut extremities should be placed oppositely to allow end sections / circuit separators placement at each cut extremities.

For all other applications, please consult us.

Technical data valid for copper conductors only.

JB85-3 cross spacing jumpers

Common terminal block accessories

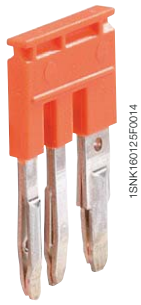

1SNK160125FP0014

JB85
8 mm 0.315 in spacing

Description

- Allows power distribution between terminal blocks with different spacing,
- JB5-3, JB6-3 and JB8-3 can be used as cross spacing jumpers (see selection table on mounting instructions below).

Ordering details

Description	Color	Type	Part Number	Pkg qty	Weight (1 pce) g
Cross spacing jumpers 3 poles	Orange	JB85-3	1SNK900603R0000	10	2.80

Main technical data

Material specifications	Insulating material	Polyamide		
	Flammability	V0		
Ambient temperature min/max	NF F 16 101	I2F3		
	Service IEC 60068-2-1	-55 ... +110 °C	-67 ... +230 °F	
	Storage	-55 ... +110 °C	-67 ... +230 °F	
	Installing	-5 ... +40 °C	+23 ... +104 °F	
Rated current		IEC	UL - CSA	Ex e
		32 A	30 A	
	Rated voltage	Standard use	1000 V	600 V
Cut extremities		800 V	300 V	
Cut poles		630 V	300 V	
Impulse withstand voltage		8000 V		
Protection		IP20	NEMA 1	

All the main technical data provided are "manufacturer" values

	RoHS								
	RoHS								

Mounting instructions

Cross spacing jumper selection between A and B terminal blocks with different spacing.

	B: 5.2 mm	6 mm	8 mm
A: 6 mm	JB5.3	-	-
A: 8 mm	JB85.3	JB85.3	-
A: 10 mm	JB85.3	JB85.3	JB8.3
A: 12 mm	JB85.3	JB6.3	-

Yellow cell: for ZS and ZK terminal blocks

Blue cell: for ZS terminal blocks only

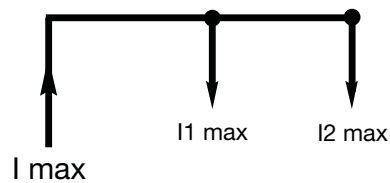

$$I1 \text{ max} + I2 \text{ max} \leq I \text{ max}$$

$$I \text{ max} \leq I \text{ rated terminal block}$$

Technical data valid for copper conductors only.

Test adapters

Common terminal block accessories



TP

7.6 mm 0.299 in spacing

Mounting instructions

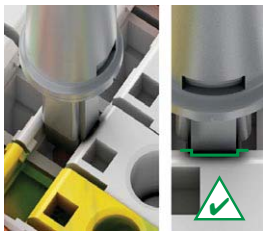

TP2 test adapters

Description

- Insulated test adapter that enables individual voltage control,
- Direct plug-in solution into the jumpers channels,
- Compatible with standard isolated or non isolated test plugs DIA 2 mm 0.079 in and 2.3 mm 0.090 in,
- Withstand more than 10000 operations according to TE Connectivity test standards.

Ordering details

Description	Color	Type	Part Number	Pkg qty	Weight (1 pce)
For test plugs DIA 2 mm 0.079 in	Dark grey	TP2	1SNK900203R0000	20	1.70

Main technical data

Material specifications	Insulating material	Polyamide			
	Flammability NF F 16 101	V0 I2F2			
Ambient temperature min/max	Service IEC 60068-2-1	-55 ... +110 °C	-67 ... +230 °F		
	Storage	-55 ... +110 °C	-67 ... +230 °F		
	Installing	-5 ... +40 °C	+23 ... +104 °F		
		IEC	UL - CSA	Ex e	
Rated current		10 A			
Rated voltage	Standard use	1000 V	600 V	Not authorized	
Impulse withstand voltage		8000 V			
Protection		IP20	NEMA 1		
All the main technical data provided are "manufacturer" values					
	RoHS				
	RoHS				



TP

7.6 mm 0.299 in spacing

Mounting instructions

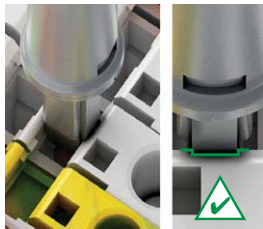

TP4 test adapters

Description

- Isolated test adapter that enables individual voltage control,
- Direct plug-in solution into the jumpers channels,
- Compatible with standard insulated or non isolated test plugs DIA 4 mm 0.157 in,
- Withstand more than 10000 operations according to TE Connectivity test standards.

Ordering details

Description	Color	Type	Part Number	Pkg qty	Weight (1 pce)
For test plugs DIA 4 mm 0.157 in	Dark grey	TP4	1SNK900205R0000	20	2.40

Main technical data

Material specifications	Insulating material	Polyamide			
	Flammability NF F 16 101	V0 I2F2			
Ambient temperature min/max	Service IEC 60068-2-1	-55 ... +110 °C	-67 ... +230 °F		
	Storage	-55 ... +110 °C	-67 ... +230 °F		
	Installing	-5 ... +40 °C	+23 ... +104 °F		
		IEC	UL - CSA	Ex e	
Rated current		16 A			
Rated voltage	Standard use	1000 V	600 V	Not authorized	
Impulse withstand voltage		8000 V			
Protection		IP20	NEMA 1		
All the main technical data provided are "manufacturer" values					
	RoHS				
	RoHS				

Technical data valid for copper conductors only.

TC5 test connectors

Common terminal block accessories



5.2 mm 0.205 in spacing

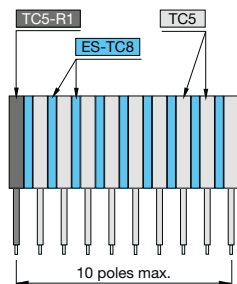
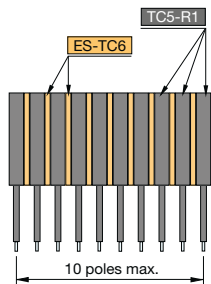
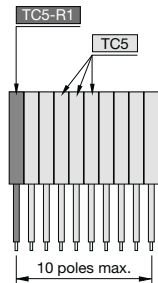

PT-3

Description

Ease the testing of terminal block assemblies:

- Make your own test connector assembly with our modular solution mixing various spacings,
- Direct plug-in solution into the jumpers channels,
- Withstand more than 10000 operations according to TE Connectivity test standards.

Main technical data

Connecting capacity		IEC	UL - CSA	Mounting instructions	
1 conductor per clamp	Rigid: Solid/Stranded	0.2 ... 1.5 mm ²		Rail	Wire stripping length 8 mm 0.314 in
	Flexible without ferrule	0.22 ... 1.5 mm ²			
	Flexible with non insulated ferrule			Tool	Flat screwdriver Ø 2.5 mm 0.098 in
	Flexible with insulated ferrule	0.22 ... 1.5 mm ²			
Gauge		A1-B1		Torque	0.5 Nm ± 0.1 3.43 lb.in ± 0.885
2 conductors per clamp	Rigid: Solid/Stranded	0.2 ... 0.75 mm ²			
	Flexible without ferrule	0.22 ... 0.75 mm ²			
	Flexible with twin ferrule	0.22 ... 0.75 mm ²			
Rated current / Rated cross section		16 A / 1.5 mm ²			
Rated short-time withstand current (1s)		180 A			
Rated voltage		1000 V			
Impulse withstand voltage		8000 V			
Protection		IP20	NEMA 1		

The connecting capacity data for one Rigid: Solid/Stranded, or one Flexible conductor (when applicable) is a mandatory information required by IEC, UL and CSA standards (Copper conductors). All other data are provided as supplementary information only. For more details, please consult our CB, UL or CSA certificates and technical datasheet available on <http://www.TE.com>

Material specifications	Insulating material	Polyamide	
	Flammability	V0	
Ambient temperature min/max	NF F 16 101	-55 ... +110 °C	-67 ... +230 °F
	Service IEC 60068-2-1	-55 ... +110 °C	-67 ... +230 °F
	Storage	-55 ... +110 °C	-67 ... +230 °F
	Installing	-5 ... +40 °C	+23 ... +104 °F

All the main technical data provided are "manufacturer" values



Ordering details

Test connectors for 5.2 mm 0.205 in spacing terminal blocks

Description	Color	Type	Part Number	Pkg qty	Weight (1 pce) g
Test connectors 5.2 mm 0.205 in spacing	Dark grey	TC5	1SNK900200R0000	10	5.20
End module, 5.2 mm 0.205 in		TC5-R1	1SNK900201R0000	10	5.20

Ordering details

Test connectors for 6 mm 0.236 in spacing terminal blocks

Description	Color	Type	Part Number	Pkg qty	Weight (1 pce) g
Test connectors End module, 5.2 mm 0.205 in	Dark grey	TC5-R1	1SNK900201R0000	10	5.20
Spacers 0.8 mm 0.031 in spacing		ES-TC6	1SNK900105R0000	10	0.80

Ordering details

Test connectors for 8 mm 0.315 in spacing terminal blocks

Description	Color	Type	Part Number	Pkg qty	Weight (1 pce) g
Test connectors 5.2 mm 0.205 in spacing	Dark grey	TC5	1SNK900200R0000	10	5.20
End module, 5.2 mm 0.205 in		TC5-R1	1SNK900201R0000	10	5.20
Spacers 2.8 mm 0.110 in spacing		ES-TC8	1SNK900104R0000	10	1.40

Accessories

Description	Color	Type	Part Number	Pkg qty	Weight (1 pce) g
Cable clamps	Dark grey	PT-3	1SNK900625R0000	20	1.00
Terminal block markers	White	MG-CPM 13 41790	1SNB041790R0512	1960	0.23
		MC512	1SNK140000R0000	22	9.00
		MC512PA	1SNK149999R0000	20	10.00
Universal wire markers holder	Grey	UMH	1SNK900611R0000	10	0.20

Technical data valid for copper conductors only.

Component plugs

Common terminal block accessories

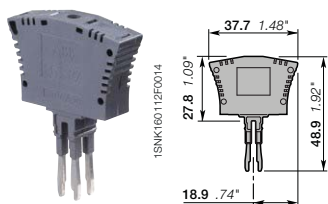

PG5

9.95 mm 0.392 in spacing

Mounting instructions

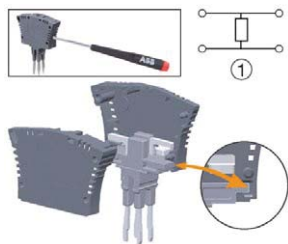

- Open the PG5-R2 with a flat screw-driver DIA . 3.5 mm 0.138 in,
- Use a soldering iron to fix your component,
- Close the PG5-R2,
- Plug-in in the terminal blocks jumper channels.

PG5-R2 component plugs

Description

- Component holder compatible with 5.2 mm 0.205 in spacing ZS4 feed-through terminal blocks,
- Fit components 16 x 16 x 8.5 mm 0.630 x 0.630 x 0.335 in (not supplied with plug) such as resistors, diodes, varistances,
- Direct plug-in into the terminal blocks jumper channels,
- Maximum dissipated power: 2 W.

Ordering details

Description	Color	Type	Part Number	Pkg qty	Weight (1 pce) g
Components insertion between 2 blocks	Dark grey <input checked="" type="checkbox"/>	PG5-R2	1SNK900403R0000	20	8.00

Main technical data

Material specifications	Insulating material	Polyamide			
	Flammability	V0			
	NF F 16 101	I2F2			
Ambient temperature min/max	Service IEC 60068-2-1	-55 ... +110 °C	-67 ... +230 °F		
	Storage	-55 ... +110 °C	-67 ... +230 °F		
	Installing	-5 ... +40 °C	+23 ... +104 °F		
		IEC	UL - CSA		
Rated current					
Rated voltage		250 V			
Impulse withstand voltage		4000 V			
Protection		IP20	NEMA 1		

All the main technical data provided are "manufacturer" values

RoHS	<input checked="" type="checkbox"/>									
RoHS										

Accessories

Description	Color	Type	Part Number	Pkg qty	Weight (1 pce) g
Terminal block markers	White <input type="checkbox"/>	MG-CPM 13 41790	1SNB041790R0512	1960	0.23
Blank card		MC512	1SNK140000R0000	22	9.00
		MC512PA	1SNK149999R0000	20	10.00
Universal wire markers holder	Grey <input type="checkbox"/>	UMH	1SNK900611R0000	10	0.20

Technical data valid for copper conductors only.

Component plugs

Common terminal block accessories

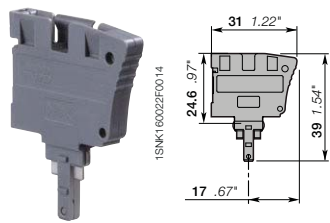

PG5
5.2 mm 0.205 in spacing

Mounting instructions



– Direct plug-in in disconnect with plug terminal block

PG5 component plugs

Description

- Ease the components installation (components not supplied with plug) with our quick plug-in mounting system which avoids soldering process,
- Accept 8.8 x 3.2 mm 0.346 x 0.125 in components such as resistors, diodes or subminiature fuses (fully encapsulated),
- Maximum dissipated power: 1 W.

Ordering details

Description	Color	Type	Part Number	Pkg qty	Weight (1 pce) g
Components in series with circuit	Dark grey <input checked="" type="checkbox"/>	PG5	1SNK900401R0000	20	3.50

Main technical data

Material specifications	Insulating material	Polyamide	
	Flammability	V0	
	NF F 16 101	I2F2	
Ambient temperature min/max	Service IEC 60068-2-1	-55 ... +110 °C	-67 ... +230 °F
	Storage	-55 ... +110 °C	-67 ... +230 °F
	Installing	-5 ... +40 °C	+23 ... +104 °F
	IEC	UL - CSA	
Rated current			
Rated voltage	400 V	150 V	
Impulse withstand voltage	6000 V		
Protection	IP20	NEMA 1	

All the main technical data provided are "manufacturer" values

	RoHS				
	RoHS				

Accessories

Description	Color	Type	Part Number	Pkg qty	Weight (1 pce) g	
Terminal block markers	White <input type="checkbox"/>	MG-CPM 13 41790	1SNB041790R0512	1960	0.23	
Blank card	In polycarbonate	MC512	1SNK140000R0000	22	9.00	
		Blank card	MC512PA	1SNK149999R0000	20	10.00
Universal wire markers holder	5.2 mm 0.205 in spacing	Grey <input type="checkbox"/>	UMH	1SNK900611R0000	10	0.20

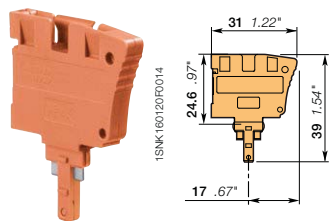

PG5
5.2 mm 0.205 in spacing

Mounting instructions



- PG5-R1 totally inserted: closed circuit,
- PG5-R1 inserted in central position: open circuit, plug secured in isolated central position

PG5-R1 disconnect plugs

Description

Allow disconnect function when associated with the disconnect with plug terminal blocks.

Ordering details

Description	Color	Type	Part Number	Pkg qty	Weight (1 pce) g
Equipped with linking bar	Orange <input checked="" type="checkbox"/>	PG5-R1	1SNK900402R0000	20	3.50

Main technical data

Material specifications	Insulating material	Polyamide	
	Flammability	V0	
	NF F 16 101	I2F3	
Ambient temperature min/max	Service IEC 60068-2-1	-55 ... +110 °C	-67 ... +230 °F
	Storage	-55 ... +110 °C	-67 ... +230 °F
	Installing	-5 ... +40 °C	+23 ... +104 °F
	IEC	UL - CSA	
Rated current	18 A	20 A	
Rated voltage	400 V	150 V	
Impulse withstand voltage	6000 V		
Protection	IP20	NEMA 1	

All the main technical data provided are "manufacturer" values

	RoHS				
	RoHS				

Accessories

Description	Color	Type	Part Number	Pkg qty	Weight (1 pce) g	
Terminal block markers	White <input type="checkbox"/>	MG-CPM 13 41790	1SNB041790R0512	1960	0.23	
Blank card	In polycarbonate	MC512	1SNK140000R0000	22	9.00	
		Blank card	MC512PA	1SNK149999R0000	20	10.00
Universal wire markers holder	5.2 mm 0.205 in spacing	Grey <input type="checkbox"/>	UMH	1SNK900611R0000	10	0.20

Technical data valid for copper conductors only.

Tools

Common terminal block accessories



TO

1SNK16024FC014

TO screwdrivers

Description

Flat head screwdriver

Ordering details

Description	Color	Type	Part Number	Pkg qty	Weight (1 pce) g
Insulated screwdriver 1000V IEC dimensions 3.5 x 100 mm 0.138 x 3.94 in		TO3.5-100-INS	1SNK900644R0000	1	37.00
screwdriver 3.5 x 50 mm 0.138 x 1.97 in		TO3.5-50	1SNK900640R0000	12	22.00
screwdriver 3.5 x 50 mm 0.138 x 1.97 in Angled 60°		TO3.5-50-A	1SNK900659R0000	12	21.6
screwdriver 4 x 100 mm 0.157 x 3.94 in		TO4-100	1SNK900641R0000	1	42.00
screwdriver 5.5 x 125 mm 0.216 x 4.92 in		TO5.5-125	1SNK900642R0000	1	75.50
screwdriver 6.5 x 150 mm 0.256 x 5.90 in		TO6.5-150	1SNK900643R0000	1	121.00



PS

1SNK16012FC014

PS crimping tools

Description

- Crimp flexible conductors equipped with ferrules from 0.08 to 10 mm² 28 AWG to 7 AWG,
- Semi-automatic crimping tool.

Ordering details

Description	Color	Type	Part Number	Pkg qty	Weight (1 pce) g
180 mm 7.09 in length		PS-3	1SNK900650R0000	1	380.00

Technical data valid for copper conductors only.

1SNK16024FC014

End sections

PI-Spring terminal block accessories



1SNK160233V0014

EK2.5

EK2.5 end sections

Description

- Unique dark grey color that fits all terminal blocks colours and ease the identification of circuits within your terminal block assemblies,
- Compatible with ZK2.5, ZK2.5-PE, ZK4, ZK4-PE, ZK6 and ZK6-PE PI-Spring screwless terminal blocks.

Ordering details

Description	Color	Type	Part Number	Pkg qty	Weight (1 pce) g
2 mm 0.079 in spacing	Dark grey 	EK2.5	1SNK705910R0000	20	1.80



1SNK160234V0014

EK2.5-3P

EK2.5-3P end sections

Description

- Unique dark grey color that fits all terminal blocks colours and ease the identification of circuits within your terminal block assemblies,
- Compatible with ZK2.5-3P, ZK2.5-PE-3P, ZK4-3P, ZK4-PE-3P, ZK2.5-S..., ZK2.5-SP and ZK2.5-SF... PI-Spring screwless terminal blocks.

Ordering details

Description	Color	Type	Part Number	Pkg qty	Weight (1 pce) g
2 mm 0.079 in spacing	Dark grey 	EK2.5-3P	1SNK705911R0000	20	2.40



1SNK160235V0014

EK2.5-4P

EK2.5-4P end sections

Description

- Unique dark grey color that fits all terminal blocks colours and ease the identification of circuits within your terminal block assemblies,
- Compatible with ZK2.5-4P, ZK2.5-PE-4P, ZK4-4P and ZK4-PE-4P PI-Spring screwless terminal blocks.

Ordering details

Description	Color	Type	Part Number	Pkg qty	Weight (1 pce) g
2 mm 0.079 in spacing	Dark grey 	EK2.5-4P	1SNK705912R0000	20	2.70

Main technical data

Material specifications	Insulating material	Polyamide			
	Flammability	V0			
	NF F 16 101	I2F2			
Ambient temperature min/max	Service IEC 60068-2-1	-55 ... +110 °C	-67 ... +230 °F		
	Storage	-55 ... +110 °C	-67 ... +230 °F		
	Installing	-5 ... +40 °C	+23 ... +104 °F		

All the main technical data provided are "manufacturer" values.

	RoHS				
	RoHS				

Technical data valid for copper conductors only.

End sections

PI-Spring terminal block accessories



1SNK160339V0014

EK2.5-S-4P

EK2.5-S-4P end sections

Description

- Unique dark grey color that fits all terminal blocks colours and ease the identification of circuits within your terminal block assemblies,
- Compatible with ZK2.5-S-4P, ZK2.5-SP-4P, ZK2.5-CH-4P... PI-Spring screwless terminal blocks.

Ordering details

Description	Color	Type	Part Number	Pkg qty	Weight (1 pce) g
2 mm 0.079 in spacing	Dark grey	EK2.5-S-4P	1SNK705913R0000	20	2.94

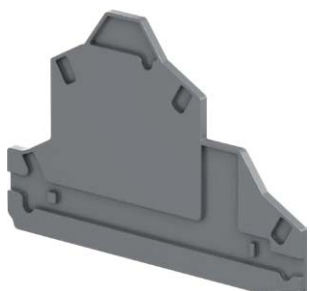

1SNK160237V0014

EK2.5-D2

EK2.5-D2 end sections

Description

- Compatible with ZK2.5-D2, ZK2.5-D2-PE, ZK2.5-D1 and ZK2.5-D1-PE PI-Spring screwless terminal blocks.

Ordering details

Description	Color	Type	Part Number	Pkg qty	Weight (1 pce) g
2 mm 0.079 in spacing	Dark grey	EK2.5-D2	1SNK705960R0000	20	3.40

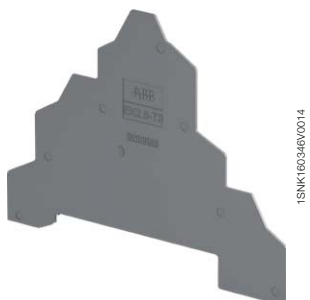

1SNK160346V0014

EK2.5-T3

EK2.5-T3 end sections

Description

- Compatible with ZK2.5-T3, ZK2.5-T1, ZK2.5-T1-PE, ZK2.5-L-L-PE and ZK2.5-L-N-PE PI-Spring screwless terminal blocks.

Ordering details

Description	Color	Type	Part Number	Pkg qty	Weight (1 pce) g
0.8 mm 0.031 in spacing	Dark grey	EK2.5-T3	1SNK705961R0000	20	4.76

Main technical data

Material specifications	Insulating material	Polyamide			
	Flammability	V0			
	NF F 16 101	I2F2			
Ambient temperature min/max	Service IEC 60068-2-1	-55 ... +110 °C	-67 ... +230 °F		
	Storage	-55 ... +110 °C	-67 ... +230 °F		
	Installing	-5 ... +40 °C	+23 ... +104 °F		

All the main technical data provided are "manufacturer" values.

RoHS					
RoHS					

Technical data valid for copper conductors only.

1SNK160065S0201

End sections

PI-Spring terminal block accessories



1SNK160238V0014

EK6-3P

EK6-3P end sections

Description

- Compatible with ZK6-3P and ZK6-PE-3P PI-Spring screwless terminal blocks.

Ordering details

Description	Color	Type	Part Number	Pkg qty	Weight (1 pce) g
2 mm 0.079 in spacing	Dark grey	EK6-3P	1SNK708911R0000	20	2.80

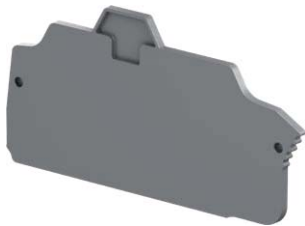

1SNK160238V0014

EK10

EK10 end sections

Description

- Compatible with ZK10, ZK10-PE, ZK16 and ZK16-PE PI-Spring screwless terminal blocks.

Ordering details

Description	Color	Type	Part Number	Pkg qty	Weight (1 pce) g
2 mm 0.079 in spacing	Dark grey	EK10	1SNK710910R0000	20	3.30



1SNK160318V0014

EK10-3P

EK10-3P end sections

Description

- Unique dark grey color that fits all terminal blocks colours and ease the identification of circuits within your terminal block assemblies,
- Compatible with ZK10-3P, ZK10-PE-3P, ZK16-3P, ZK16-PE-3P... PI-Spring screwless terminal blocks.

Ordering details

Description	Color	Type	Part Number	Pkg qty	Weight (1 pce) g
2 mm 0.079 in spacing	Dark grey	EK10-3P	1SNK710911R0000	20	4.5

Main technical data

Material specifications	Insulating material	Polyamide			
	Flammability	V0			
	NF F 16 101	I2F2			
Ambient temperature min/max	Service IEC 60068-2-1	-55 ... +110 °C	-67 ... +230 °F		
	Storage	-55 ... +110 °C	-67 ... +230 °F		
	Installing	-5 ... +40 °C	+23 ... +104 °F		

All the main technical data provided are "manufacturer" values.

	RoHS				
	RoHS				

Technical data valid for copper conductors only.

Circuit separators

PI-Spring terminal blocks accessories



1SNK160240V0014

CS-R2

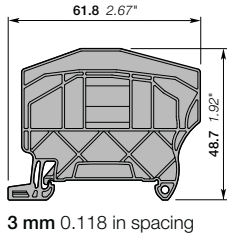

CS-R2 circuit separators

Description

- Compact circuits separator solution (only 3mm spacing) which provides a convenient visual identification of the several circuits within terminal assemblies,
- Unique top marking possibility that can replace the conventional solution of "end stop with label holder" for demanding applications with high space constraints, - Compatible with all PI-spring feed-through and ground terminal blocks up to 8 mm spacing,
- Mounting on DIN3-TH35 rail.

Ordering details

Description	Color	Type	Part Number	Pkg qty	Weight (1 pce) g
3 mm 0.118 in spacing	Dark grey 	CS-R2	1SNK900106R0000	20	3.80

Main technical data

Material specifications	Insulating material	Polyamide			
	Flammability	V0			
	NF F 16 101	I2F2			
Ambient temperature min/max	Service IEC 60068-2-1	-55 ... +110 °C	-67 ... +230 °F		
	Storage	-55 ... +110 °C	-67 ... +230 °F		
	Installing	-5 ... +40 °C	+23 ... +104 °F		

All the main technical data provided are "manufacturer" values

RoHS 					
--	--	--	--	--	--

Accessories

Description	Color	Type	Part Number	Pkg qty	Weight (1 pce) g
Terminal block markers	White <input type="checkbox"/>	MG-CPM 13 41791	1SNB041791R0612	1680	0.27
Labels	Yellow <input checked="" type="checkbox"/>	MG-VYT 46415	1SNB046415R0615	5250	0.04
	White <input type="checkbox"/>	MG-VYT 46915	1SNB046915R0615	5250	0.05
Blank card	In polycarbonate	White <input type="checkbox"/>	MC612	22	10.00
		Blank card	MC612PA	20	11.00
Universal wire markers holder 5.2 mm 0.205 in spacing	Grey <input type="checkbox"/>	UMH	1SNK900611R0000	10	0.20

Technical data valid for copper conductors only.

Circuit separators

PI-Spring terminal blocks accessories



1SNK160241V0014

CS-R3

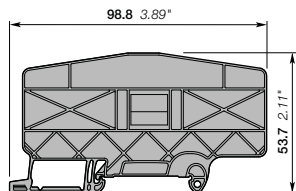

3 mm 0.118 in spacing

CS-R3 circuit separators

Description

- Compact circuits separator solution (only 3mm spacing) which provides a convenient visual identification of the several circuits within terminal assemblies,
- Unique top marking possibility that can replace the conventional solution of "end stop with label holder" for demanding applications with high space constraints,
- Compatible with all single deck PI-spring terminal blocks and ZS10-ST...terminal blocks ,
- Mounting on DIN3-TH35 rail.

Ordering details

Description	Color	Type	Part Number	Pkg qty	Weight (1 pce) g
3 mm 0.118 in spacing	Dark grey <input checked="" type="checkbox"/>	CS-R3	1SNK900107R0000	20	6.40

Main technical data

Material specifications	Insulating material	Polyamide			
	Flammability	V0			
	NF F 16 101	I2F2			
Ambient temperature min/max	Service IEC 60068-2-1	-55 ... +110 °C	-67 ... +230 °F		
	Storage	-55 ... +110 °C	-67 ... +230 °F		
	Installing	-5 ... +40 °C	+23 ... +104 °F		

All the main technical data provided are "manufacturer" values

	RoHS																		
	RoHS																		

Accessories

Description	Color	Type	Part Number	Pkg qty	Weight (1 pce) g	
Terminal block markers	White <input type="checkbox"/>	MG-CPM 13 41790	1SNB041790R0512	1960	0.23	
		MG-CPM 13 41791	1SNB041791R0612	1680	0.27	
Labels	Yellow <input checked="" type="checkbox"/>	MG-VYT 46415	1SNB046415R0615	5250	0.04	
	White <input type="checkbox"/>	MG-VYT 46915	1SNB046915R0615	5250	0.05	
Blank card	White <input type="checkbox"/>	In polycarbonate	MC512	1SNK140000R0000	22	9.00
		Blank card	MC512PA	1SNK149999R0000	20	10.00
		In polycarbonate	MC612	1SNK150000R0000	22	10.00
		Blank card	MC612PA	1SNK159999R0000	20	11.00
Universal wire markers holder	5.2 mm 0.205 in spacing	Grey <input type="checkbox"/>	UMH	1SNK900611R0000	10	0.20

Technical data valid for copper conductors only.

End sections

Screw clamp terminal block accessories



1SNK161013F0014

ES4

ES4 end sections

Description

- Unique dark grey color that fits all terminal blocks colours and ease the identification of circuits within your terminal block assemblies,
- Compatible with feed-through, ground and disconnect screw clamp terminal blocks.

Ordering details

Description	Color	Type	Part Number	Pkg qty	Weight (1 pce) g
2.2 mm 0.087 in spacing	Dark grey	ES4	1SNK505910R0000	20	2.20



1SNK160229V0014

ES6-3S

ES6-3S end sections

Description

- Compatible with ZS6-3S and ZS6-3S-PE terminal blocks.

Ordering details

Description	Color	Type	Part Number	Pkg qty	Weight (1 pce) g
2.2 mm 0.087 in spacing	Dark grey	ES6-3S	1SNK505912R0000	20	2.50



1SNK160230V0014

ES6-4S

ES6-4S end sections

Description

- Compatible with ZS6-4S, ZS6-4S-PE, ZS6-S-4S-T2 and ZS4-PE-R2 terminal blocks.

Ordering details

Description	Color	Type	Part Number	Pkg qty	Weight (1 pce) g
2.2 mm 0.087 in spacing	Dark grey	ES6-4S	1SNK505911R0000	20	3.10



1SNK161012F0014

ES4-D2

ES4-D2 end sections

Description

- Unique dark grey color that fits all terminal blocks colours and ease the identification of circuits within your terminal block assemblies,
- Compatible with double deck screw clamp terminal blocks

Ordering details

Description	Color	Type	Part Number	Pkg qty	Weight (1 pce) g
2.55 mm 0.100 in spacing	Dark grey	ES4-D2	1SNK505960R0000	20	4.10

Main technical data

Material specifications	Insulating material	Polyamide			
	Flammability	V0			
	NF F 16 101	I2F2			
Ambient temperature min/max	Service IEC 60068-2-1	-55 ... +110 °C	-67 ... +230 °F		
	Storage	-55 ... +110 °C	-67 ... +230 °F		
	Installing	-5 ... +40 °C	+23 ... +104 °F		

All the main technical data provided are "manufacturer" values.

	RoHS				
	RoHS				

Technical data valid for copper conductors only.

End sections

Screw clamp terminal block accessories

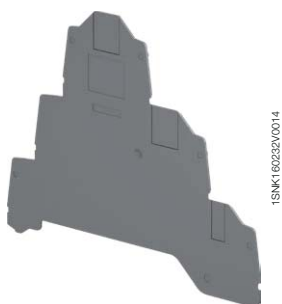

1SNK160231V0014

ES4-T3

ES4-T3 end sections

Description

– Compatible with ZS4-T3 terminal block.

Ordering details

Description	Color	Type	Part Number	Pkg qty	Weight (1 pce) g
0.8 mm 0.031 in spacing	Dark grey	ES4-T3	1SNK505961R0000	20	4.20

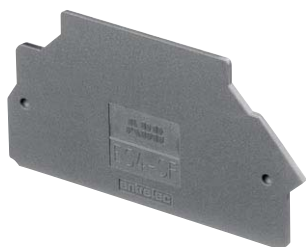

1SNK161026F0014

ES4-SF

ES4-SF end sections

Description

– Compatible with fuse ZS4-SF1... and disconnect screw clamp terminal blocks ZS4-S-R3.

Ordering details

Description	Color	Type	Part Number	Pkg qty	Weight (1 pce) g
1.5 mm 0.059 in spacing	Dark grey	ES4-SF	1SNK508960R0000	20	1.80

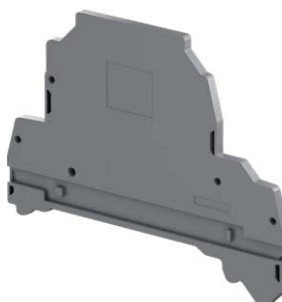

1SNK160231V0014

ES4-D2-SF1

ES4-D2-SF1 end sections

Description

– Compatible with ZS4-D2-SF1 ... terminal blocks.

Ordering details

Description	Color	Type	Part Number	Pkg qty	Weight (1 pce) g
2.5 mm 0.098 in spacing	Dark grey	ES4-D2-SF1	1SNK508911R0000	20	5.00



1SNK161072F0014

ES10-ST

ES10-ST end sections

Description

– Unique dark grey color that fits all test disconnect terminal blocks ZS10-ST... and ease the identification of circuits within your terminal block assemblies,
– Also compatible with ZS10-R1 and ZS10-PE-R1.

Ordering details

Description	Color	Type	Part Number	Pkg qty	Weight (1 pce) g
2 mm 0.079 in spacing	Dark grey	ES10-ST	1SNK508910R0000	20	3.5

Accessories

Description	Color	Type	Part Number	Pkg qty	Weight (1 pce) g
Circuit separators	Dark grey	CS	1SNK900101R0000	20	0.20

Main technical data

Material specifications	Insulating material	Polyamide			
	Flammability	V0			
	NF F 16 101	I2F2			
Ambient temperature min/max	Service IEC 60068-2-1	-55 ... +110 °C	-67 ... +230 °F		
	Storage	-55 ... +110 °C	-67 ... +230 °F		
	Installing	-5 ... +40 °C	+23 ... +104 °F		

All the main technical data provided are "manufacturer" values.

RoHS					
RoHS					

Technical data valid for copper conductors only.

1SNK160062S0201

Screw jumper bars

Screw clamp terminal block accessories



1SNK160212F0014

JB8
8 mm 0.315 in spacing

Mounting instructions

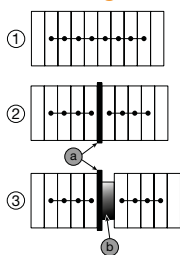

- 1 - Rated voltage: 160 V (IEC) / Not authorized (UL)
- 2 - Rated voltage: 320 V (IEC) / Not authorized (UL)
- 3 - Rated voltage: 1000 V (IEC) / 300 V (UL)
- a - End section ES10-ST
- b - End stop BAZ1

JB8 jumper bars

Description

Insulated jumper bar with screw mounting.

Ordering details

Description		Color	Type	Part Number	Pkg qty	Weight (1 pce) g
8 mm 0.315 in spacing	2 poles	Orange	JB8-2-R1	1SNK908902R0000	10	7.6
	3 poles		JB8-3-R1	1SNK908903R0000	10	11.6
	4 poles		JB8-4-R1	1SNK908904R0000	10	15.5
	5 poles		JB8-5-R1	1SNK908905R0000	10	19.4
	10 poles		JB8-10-R1	1SNK908910R0000	10	39.00

Main technical data

Material specifications	Insulating material	Polyamide		Rail	
	Flammability	V0		Tool	
Ambient temperature min/max	NF F 16 101	I2F3		Torque	
	Service IEC 60068-2-1	-55 ... +110 °C	-67 ... +230 °F		
	Storage	-55 ... +110 °C	-67 ... +230 °F	Not authorized	
	Installing	-5 ... +40 °C	+23 ... +104 °F		
Rated current		IEC	UL - CSA	Ex e	
Rated voltage	Standard use	50 A	51 A		
		160 V			
Alternated poles				Not authorized	
Impulse withstand voltage					
Protection		IP20	NEMA 1		
All the main technical data provided are "manufacturer" values					
RoHS					
RoHS					

Technical data valid for copper conductors only.

Screw jumper bars

Screw clamp terminal block accessories



1SNK16012AF0014

JB16
16 mm 0.630 in spacing

Mounting instructions



- With flat pliers, cut out the partitions on the terminal block insulating body. Be careful to not cut out the jumpered terminal blocks partitions at both ends of the assembly in order to maintain the IP20, Nema1 protection and insulation,
- Install the jumper bar with the recommended tool and torque.

JB16 jumper bars

Description

Insulated jumper bar with screw mounting.

Ordering details

Description		Color	Type	Part Number	Pkg qty	Weight (1 pce) g
16 mm 0.630 in spacing	2 poles	Orange	JB16-2	1SNK916302R0000	10	10.00
	3 poles		JB16-3	1SNK916303R0000	10	16.00
	4 poles		JB16-4	1SNK916304R0000	10	22.00
	5 poles		JB16-5	1SNK916305R0000	10	28.00
	10 poles		JB16-10	1SNK916310R0000	10	56.60

Main technical data

Material specifications	Insulating material Flammability NF F 16 101	Polyamide V0 I2F3	Rail		
Ambient temperature min/max	Service IEC 60068-2-1	-55 ... +110 °C	-67 ... +230 °F	Tool	Flat screwdriver Ø 5.5 mm Ø 0.217 in 1.2 Nm ± 0.1 10.6 lb.in ± 0.885
	Storage	-55 ... +110 °C	-67 ... +230 °F	Torque	
	Installing	-5 ... +40 °C	+23 ... +104 °F		
Rated current		IEC 125 A	UL - CSA 150 A	Ex e	
Rated voltage	Standard use	1000 V	600 V		
		Alternated poles			Not authorized
Impulse withstand voltage		8000 V			
Protection		IP20	NEMA 1		

All the main technical data provided are "manufacturer" values

RoHS																			
------	--	--	--	--	--	--	--	--	--	--	--	--	--	--	--	--	--	--	--

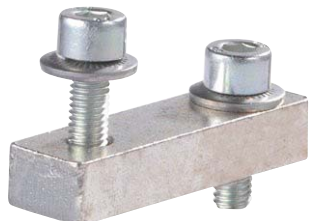

1SNK160100F0014

JB22
22 mm 0.866 in spacing

Mounting instructions



- With flat pliers, cut out the partitions on the terminal block insulating body. Be careful to not cut out the jumpered terminal blocks partitions at both ends of the assembly in order to maintain the IP20, Nema1 protection and insulation,
- Install the jumper bar with the recommended tool and torque.

JB22 jumper bars

Description

Screw jumper bars

Ordering details

Description		Color	Type	Part Number	Pkg qty	Weight (1 pce) g
22 mm 0.866 in spacing	2 poles		JB22-2	1SNK922302R0000	5	27.00
	3 poles		JB22-3	1SNK922303R0000	5	43.30
	5 poles		JB22-5	1SNK922305R0000	5	76.10
	10 poles		JB22-10	1SNK922310R0000	5	157.40

Main technical data

Material specifications	Insulating material Flammability NF F 16 101	Polyamide	Rail		
Ambient temperature min/max	Service IEC 60068-2-1	-55 ... +110 °C	-67 ... +230 °F	Tool	Allen key Ø 4 mm Ø 0.157 in 2 Nm ± 0.4 17.7 lb.in ± 3.54
	Storage	-55 ... +110 °C	-67 ... +230 °F	Torque	
	Installing	-5 ... +40 °C	+23 ... +104 °F		
Rated current		IEC 192 A	UL - CSA 175 A	Ex e	
Rated voltage	Standard use	1000 V	600 V	630 V	
		Alternated poles			Not authorized
Impulse withstand voltage		8000 V			
Protection		IP20			

All the main technical data provided are "manufacturer" values

RoHS																			
------	--	--	--	--	--	--	--	--	--	--	--	--	--	--	--	--	--	--	--

Technical data valid for copper conductors only.

Screw jumper bars

Screw clamp terminal block accessories

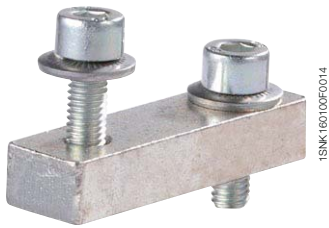

1SNK160100F0014

BJMI31

31 mm 1.22 in spacing

Mounting instructions



- With flat pliers, cut out the partitions on the terminal block insulating body. Be careful to not cut out the jumpered terminal blocks partitions at both ends of the assembly in order to maintain the IP20, Nema1 protection and insulation,
- Install the jumper bar with the recommended tool and torque.

BJMI31 jumper bars

Description

Screw jumper bars

Ordering details

Description		Color	Type	Part Number	Pkg qty	Weight (1 pce) g
31mm 1.220 in spacing	2 poles		BJMI31.2	1SNA206053R0700	1	120.00
	3 poles		BJMI31.3	1SNA206054R0000	1	190.00

Main technical data

Material specifications	Insulating material			Rail		
	Flammability			Tool		Allen key Ø 5 mm Ø 0.196 in
Ambient temperature min/max	Service IEC 60068-2-1	-55 ... +110 °C	-67 ... +230 °F	Torque		3 Nm ± 0.4 26.55 lb.in ± 3.54
	Storage	-55 ... +110 °C	-67 ... +230 °F			
	Installing	-5 ... +40 °C	+23 ... +104 °F			
Rated current		IEC	UL - CSA	Ex e		
Rated voltage	Standard use	309 A	445 A			
		1000 V	600 V			
	Alternated poles			Not authorized		
Impulse withstand voltage		8000 V				
Protection		IP20				

All the main technical data provided are "manufacturer" values

	RoHS					
	RoHS					

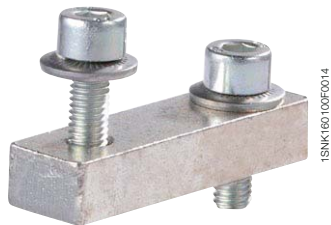

1SNK160100F0014

BJMI36

36 mm 1.42 in spacing

Mounting instructions

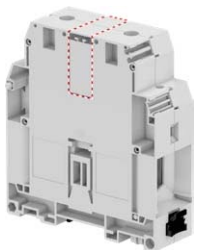

- With flat pliers, cut out the partitions on the terminal block insulating body. Be careful to not cut out the jumpered terminal blocks partitions at both ends of the assembly in order to maintain the IP20, Nema1 protection and insulation,
- Install the jumper bar with the recommended tool and torque.

BJMI36 jumper bars

Description

Screw jumper bars

Ordering details

Description		Color	Type	Part Number	Pkg qty	Weight (1 pce) g
36mm 1.4117 n spacing	2 poles		BJMI36.2	1SNA206126R2500	1	170.00
	3 poles		BJMI36.3	1SNA206223R0600	1	260.00

Main technical data

Material specifications	Insulating material			Rail		
	Flammability			Tool		Allen key Ø 5 mm Ø 0.196 in
Ambient temperature min/max	Service IEC 60068-2-1	-55 ... +110 °C	-67 ... +230 °F	Torque		3 Nm ± 0.4 26.55 lb.in ± 3.54
	Storage	-55 ... +110 °C	-67 ... +230 °F			
	Installing	-5 ... +40 °C	+23 ... +104 °F			
Rated current		IEC	UL - CSA	Ex e		
Rated voltage	Standard use	415 A	620 A			
		1000 V	600 V			
	Alternated poles			Not authorized		
Impulse withstand voltage		8000 V				
Protection		IP20				

All the main technical data provided are "manufacturer" values

	RoHS					
	RoHS					

Technical data valid for copper conductors only.

Lateral jumper bars

Screw clamp terminal block accessories



1SN160112P0014

PC8
8 mm 0.315 in spacing

Mounting instructions for ZS10-ST...

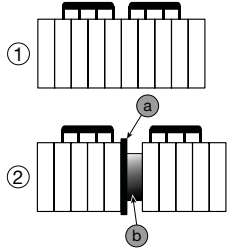

- 1 - Rated voltage: 630 V (IEC) / 150 V (UL)
- 2 - Rated voltage: 630 V (IEC) / 300 V (UL)
- a - End section ES10-ST
- b - End stop BAZ1

PC8 lateral jumper bars

Description

IP20 Comb jumper bars,

- direct insertion in the screw clamp before tightening the screws, above the eventual conductor (if conductor used with ferrule, we recommend the use of long ferrule for optimized mounting ergonomony with test disconnect terminal blocks),
- Multiple versions available in pre-cut poles for test disconnect terminal blocks applications.

Ordering details

Description	Color	Type	Part Number	Pkg qty	Weight (1 pce) g
Lateral jumper bars					
8 mm 0.315 in spacing	Black ■	PC8-2	1SNA116538R1700	10	3.00
		PC8-3	1SNA116539R1000	10	4.00
		PC8-4	1SNA116540R2500	10	6.00
		PC8-10	1SNA163313R2400	10	14.00
Lateral jumper bars pre-cut poles					
8 mm 0.315 in spacing	Black ■	PC8-R1	1SNA400711R0600	10	6.60
		PC8-R2	1SNA400712R0700	10	7.80
		PC8-R3	1SNA400713R0000	10	9.00
		PC8-R4	1SNA400724R0300	10	4.50
		PC8-R5	1SNA400842R0000	10	6.60
		PC8-R6	1SNA400843R0000	10	6.60
		PC8-R7	1SNA400849R0000	10	6.60
		PC8-R8	1SNA400850R0000	10	7.80

Main technical data

Material specifications	Insulating material	Polyamide			
	Flammability	V0			
	NF F 16 101	I2F3			
Ambient temperature min/max	Service IEC 60068-2-1	-55 ... +110 °C	-67 ... +230 °F		
	Storage	-55 ... +110 °C	-67 ... +230 °F		
	Installing	-5 ... +40 °C	+23 ... +104 °F		

All the main technical data provided are "manufacturer" values

RoHS
RoHS

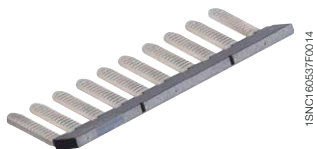

1SN160537F0014

PC81
8 mm 0.315 in spacing

PC81 lateral jumper bars

Description

Comb-type jumper bar, allows the connection of consecutive blocks or not by one compression clamp connection.

Ordering details

Description	Color	Type	Part Number	Pkg qty	Weight (1 pce) g
8 mm 0.315 in spacing	Grey ■	PC81-10	1SNA173523R1100	10	5.00

Main technical data

Material specifications	Insulating material	Brass/polyamide			
	Flammability	V0			
	NF F 16 101	I2F3			
Ambient temperature min/max	Service IEC 60068-2-1	-55 ... +110 °C	-67 ... +230 °F		
	Storage	-55 ... +110 °C	-67 ... +230 °F		
	Installing	-5 ... +40 °C	-23 ... +104 °F		

All the main technical data provided are "manufacturer" values

RoHS
RoHS

Technical data valid for copper conductors only.

Circuit separators

Screw clamp terminal block accessories



1SNK16002P0014

CS
0 mm 0 in spacing

Mounting instructions



CS circuit separators

Description

- The CS circuit separator avoids the derating of terminal blocks when cut jumper bars JB are used,
- Compatible with feed-through terminal blocks up to 16 mm² 4 AWG,
- Without spacing loss.

Ordering details

Description	Color	Type	Part Number	Pkg qty	Weight (1 pce)
0 mm 0 in spacing	Dark grey <input checked="" type="checkbox"/>	CS	1SNK900101R0000	20	0.20

Main technical data

Material specifications	Insulating material	Polyamide	
Flammability	NF F 16 101	V0	
Ambient temperature min/max	Service IEC 60068-2-1	-55 ... +110 °C	-67 ... +230 °F
	Storage	-55 ... +110 °C	-67 ... +230 °F
	Installing	-5 ... +40 °C	+23 ... +104 °F

All the main technical data provided are "manufacturer" values

RoHS	<input checked="" type="checkbox"/>
RoHS	



1SNK16003P0014

CS-R1

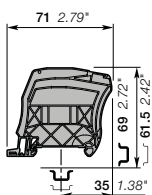

3 mm 0.118 in spacing

CS-R1 circuit separators

Description

- Ease the visual identification of the several circuits within your terminal block assemblies,
- Compatible with feed-through terminal blocks up to 35 mm² 0 AWG,
- Intermediate cover holder for CO protective cover,
- Mounting on DIN3-TH35 rail.

Ordering details

Description	Color	Type	Part Number	Pkg qty	Weight (1 pce)
3 mm 0.118 in spacing	Dark grey <input checked="" type="checkbox"/>	CS-R1	1SNK900103R0000	20	5.20

Main technical data

Material specifications	Insulating material	Polyamide	
Flammability	NF F 16 101	V0	
Ambient temperature min/max	Service IEC 60068-2-1	-55 ... +110 °C	-67 ... +230 °F
	Storage	-55 ... +110 °C	-67 ... +230 °F
	Installing	-5 ... +40 °C	+23 ... +104 °F

All the main technical data provided are "manufacturer" values

RoHS	<input checked="" type="checkbox"/>
RoHS	

Mounting instructions



Accessories

Description	Color	Type	Part Number	Pkg qty	Weight (1 pce)
Terminal block markers	White <input type="checkbox"/>	MG-CPM 13 41790	1SNB041790R0512	1960	0.23
Blank card		MC512	1SNK140000R0000	22	9.00
		MC512PA	1SNK149999R0000	20	10.00
Universal wire markers holder 5.2 mm 0.205 in spacing	Grey <input type="checkbox"/>	UMH	1SNK900611R0000	10	0.20

Technical data valid for copper conductors only.

Shield connectors

Screw clamp terminal block accessories



SHBS/SHB

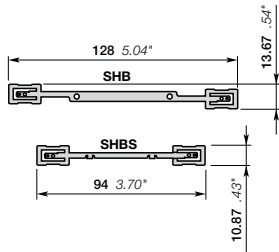

SHBS/SHB shield connectors

Description

- Ensure the continuity of your shield connection,
- Various connection solutions available: RILS cable ties, soldering, quick-connect.

Ordering details

Description	Color	Type	Part Number	Pkg qty	Weight (1 pce) g
Compatible with ZS feed-through terminal blocks		SHBS	1SNK900600R0000	20	3.50
Compatible with ZS and ZK double deck terminal blocks		SHB	1SNK900602R0000	20	4.90

Main technical data

Material specifications	Insulating material				
	Flammability				
Ambient temperature min/max	Service IEC 60068-2-1	-55 ... +110 °C	-67 ... +230 °F		
	Storage	-55 ... +110 °C	-67 ... +230 °F		
	Installing	-5 ... +40 °C	+23 ... +104 °F		

SHBS	IEC	UL - CSA	Ex e
Rated voltage	320 V		125 V

All the main technical data provided are "manufacturer" values

	RoHS								
	RoHS								

Accessories for screw clamp and PI-Spring terminal blocks

Description	Color	Type	Part Number	Pkg qty	Weight (1 pce) g
Cable ties	For SNK shield connector	RILS	1SNK900627R0000	10	0.30

Mounting instructions



- SHBS is directly fixed on the terminal block,
- SHB is fixed on the ES4-D2 end section,
- SHBP is directly fixed on the terminal block,
- Connect the cable shielding on the shielding connector with:
 - RILS cable ties,
 - quick-connect (the shield connector needs to be prepared),
 - soldering iron.

Technical data valid for copper conductors only.

PL protecting covers

Screw clamp terminal block accessories



1SNK16006P0014

PL

Mounting instructions



- The mounting of the PL does not require a screwdriver,
- The dismantling of the PL requires a screwdriver DIA .4 mm 0.160 in, the screwdriver must be positioned in the cover centered hole.

Description

- Prohibit access to the screw clamps,
- Indicate live circuits.

Ordering details

Description	Color	Type	Part Number	Pkg qty	Weight (1 pce) g
5.2 mm 0.205 in spacing	Transparent	<input checked="" type="checkbox"/> PL5	1SNK900618R0000	10	1.50
6 mm 0.236 in spacing		PL6	1SNK900619R0000	10	1.80
8 mm 0.315 in spacing		PL8	1SNK900620R0000	10	2.60
10 mm 0.394 in spacing		PL10	1SNK900621R0000	10	3.10
16 mm 0.630 in spacing		PL16	1SNK900622R0000	10	4.60

Main technical data

Material specifications	Insulating material	Polycarbonate	
	Flammability	V2	
Ambient temperature min/max	NF F 16 101		
	Service IEC 60068-2-1	-55 ... +110 °C	-67 ... +230 °F
	Storage	-55 ... +110 °C	-67 ... +230 °F
	Installing	-5 ... +40 °C	+23 ... +104 °F

Mounting instructions

Tool		Flat screwdriver Ø 4 mm Ø 0.157 in
------	--	--

All the main technical data provided are "manufacturer" values

	RoHS RoHS																		
--	---------------------	--	--	--	--	--	--	--	--	--	--	--	--	--	--	--	--	--	--

Technical data valid for copper conductors only.

Protecting covers

Screw clamp terminal block accessories



1SNK160110F0014

CO

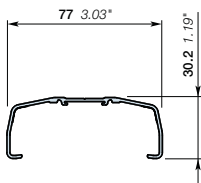

CO protecting covers

Description

- Restrict access to your assembly with the protecting cover CO installed with KCO mounting kit (2 end stops, 2 sealing accessories),
- Compatible with SNK feed-through terminal blocks up to 35 mm² 0 AWG.

Ordering details

Description	Color	Type	Part Number	Pkg qty	Weight (1 pce) g
1 m 39.4 in length	Transparent <input checked="" type="checkbox"/>	CO	1SNK900604R0000	1	300.00

Main technical data

Material specifications	Insulating material	PVC			
	Flammability	V0			
	NF F 16 101				
Ambient temperature min/max	Service IEC 60068-2-1	-55 ... +80 °C	-67 ... +176 °F		
	Storage	-55 ... +80 °C	-67 ... +176 °F		
	Installing	-5 ... +40 °C	+23 ... +104 °F		

All the main technical data provided are "manufacturer" values

RoHS
RoHS

Accessories

Description	Color	Type	Part Number	Pkg qty	Weight (1 pce) g
Protecting cover kits	Dark grey <input checked="" type="checkbox"/>	KCO	1SNK900624R0000	1	47.80
Label	White <input type="checkbox"/>	PAM43020	1SNA235106R2600	20	27.00

Mounting instructions



- Restrict access to the circuit by sealing the cover:
- Drill on the CO center line at 5 mm 0.197 in from the extremity with 5 mm 0.197 in diameter drill,
 - Pass the sealing collar through the CO and KCO holes.



1SNK160144F0014

KCO

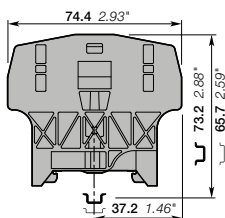

KCO protecting cover kits

Description

Mount your protecting cover with the KCO versatile mounting kit (2 end stops, 2 sealing accessories):

- Maintain the cover,
- Reliably seal the access to the terminal assembly if needed,
- Use it as well as an end stop.

Ordering details

Description	Color	Type	Part Number	Pkg qty	Weight (1 pce) g
Mounting kit for cover CO	Dark grey <input checked="" type="checkbox"/>	KCO	1SNK900624R0000	1	47.80

Main technical data

Material specifications	Insulating material	Polyamide	Rail	G32, TH 35-7.5, TH 35-15, TH 15-5.5
	Flammability	V0	Tool	Flat screwdriver Ø 4 mm Ø 0.157 in
	NF F 16 101			
Ambient temperature min/max	Service IEC 60068-2-1	-55 ... +110 °C	-67 ... +230 °F	
	Storage	-55 ... +110 °C	-67 ... +230 °F	
	Installing	-5 ... +40 °C	+23 ... +104 °F	

All the main technical data provided are "manufacturer" values

RoHS
RoHS

Technical data valid for copper conductors only.

Short circuit bridges

Screw clamp terminal block accessories



1SNK900221F0014

SC-JB8

8 mm 0.315 in spacing

SC-JB8 short circuit bridges

Description

- Allow safe short-circuiting of current Transformers circuits,
- Insulated,
- Fully operated by screwdriver,
- Short circuited fixed position secured thanks to AJS9 tightening,
- Adapted hook shape maintains the bridge on the terminal block in the non short-circuited position,
- The orange version can be used as fixed jumpers.

Ordering details

Description		Color	Type	Part Number	Pkg qty	Weight (1 pce) g
8 mm 0.315 in spacing	2 poles	Yellow ■	SC-JB8-2	1SNK900652R0000	25	2.00
	3 poles		SC-JB8-3	1SNK900653R0000	25	3.4
	4 poles		SC-JB8-4	1SNK900654R0000	25	4.7
	3/5 poles		SC-JB8-5	1SNK900655R0000	25	4.7
	3 poles		Orange ■	SC-JB8-3-OR	1SNK900657R0000	25
	4 poles	SC-JB8-4-OR		1SNK900658R0000	25	

Main technical data

Material specifications	Insulating material	Polyamide			
	Flammability	V0			
	NF F 16 101	I2F3			
Ambient temperature min/max	Service IEC 60068-2-1	-55 ... +110 °C	-67 ... +230 °F		
	Storage	-55 ... +110 °C	-67 ... +230 °F		
	Installing	-5 ... +40 °C	+23 ... +104 °F		

All the main technical data provided are "manufacturer" values

	RoHS																		
	RoHS																		

Technical data valid for copper conductors only.

End sections

Pluggable terminal block accessories



EDK2.5-22

1SNK805910R0000

EDK2.5-22 end sections

Description

– Compatible with ZDK2.5-22 and ZDK4-22 pluggable terminal blocks.

Description	Color	Type	Part Number	Pkg qty	Weight 1 pce g
2.2 mm 0.087 in spacing	Dark grey	■ EDK2.5-22	1SNK805910R0000	20	3.08



EDK2.5-21

1SNK805914R0000

EDK2.5-21 end sections

Description

– Compatible with ZDK2.5-11, ZDK2.5-11-BL and ZDK2.5-11-PE pluggable terminal blocks.

Description	Color	Type	Part Number	Pkg qty	Weight 1 pce g
1.5 mm 0.059 in spacing	Dark grey	■ EDK2.5-21	1SNK805914R0000	20	1.90



EDK2.5-11

1SNK805915R0000

EDK2.5-11 end sections

Description

– Compatible with ZD2.5-11 pluggable terminal blocks.

Description	Color	Type	Part Number	Pkg qty	Weight 1 pce g
1.5 mm 0.059 in spacing	Dark grey	■ EDK2.5-11	1SNK805915R0000	20	1.49



EDK2.5-D

1SNK805913R0000

EDK2.5-D end sections

Description

– Compatible with ZDK2.5-D2, ZDK2.5-D2-BL, ZDK2.5-D1, ZDK2.5-D1-PE and ZDK2.5-D2-PE pluggable terminal blocks.

Description	Color	Type	Part Number	Pkg qty	Weight 1 pce g
2 mm 0.079 in spacing	Dark grey	■ EDK2.5-D	1SNK805913R0000	20	3.88

Main technical data

Material specifications	Insulating material	Polyamide	
	Flammability	V0	
	NF F 16 101	I2F2	
Ambient temperature min/max	Service IEC 60068-2-1	-55 ... +110 °C	-67 ... +230 °C
	Storage	-55 ... +110 °C	-67 ... +230 °C
	Installing	-5 ... +40 °C	+23 ... +104 °C

All the main technical data provided are "manufacturer" values.

RoHS

RoHS

Technical data valid for copper conductors only.

1SNK164-0335/0201

End sections

Pluggable terminal block accessories



1SNK164023V0014

ED2.5-22

ED2.5-22 end sections

Description

– Compatible with ZD2.5-22 and ZD2.5-22-PE pluggable terminal blocks.

Ordering details

Description	Color	Type	Part Number	Pkg qty	Weight (1 pce) g
2 mm 0.079 in spacing	Dark grey	ED2.5-22	1SNK805917R0000	20	3.64



1SNK163032V0014

EDS4-22

EDS4-22 end sections

Description

– Compatible with ZDS4-22 pluggable terminal block.

Ordering details

Description	Color	Type	Part Number	Pkg qty	Weight (1 pce) g
0.8 mm 0.031 in spacing	Dark grey	EDS4-22	1SNK805911R0000	20	1.85

Main technical data

Material specifications	Insulating material	Polyamide	
	Flammability	V0	
	NF F 16 101	I2F2	
Ambient temperature min/max	Service IEC 60068-2-1	-55 ... +110 °C	-67 ... +230 °C
	Storage	-55 ... +110 °C	-67 ... +230 °C
	Installing	-5 ... +40 °C	+23 ... +104 °C

All the main technical data provided are "manufacturer" values.

RoHS:																			
RoHS:																			

Technical data valid for copper conductors only.

Coding pegs - Locking devices

Pluggable terminal block accessories



1SNK16028B0014

COP

COP coding pegs

Description

– The coding pegs prevent plugs to be inserted into the wrong circuit.

Ordering details

Description	Color	Type	Part Number	Pkg qty	Weight (1 pce)
	Dark grey	COP-ZD	1SNK900636R0000	10	3.57

Main technical data

Material specifications	Insulating material	Polyamide	
	Flammability	V0	
	NF F 16 101	I2F2	
Ambient temperature min/max	Service IEC 60068-2-1	-55 ... +110 °C	-67 ... +230 °F
	Storage	-55 ... +110 °C	-67 ... +230 °F
	Installing	-5 ... +40 °C	+23 ... +104 °F

All the main technical data provided are "manufacturer" values.

RoHS

Mounting instructions

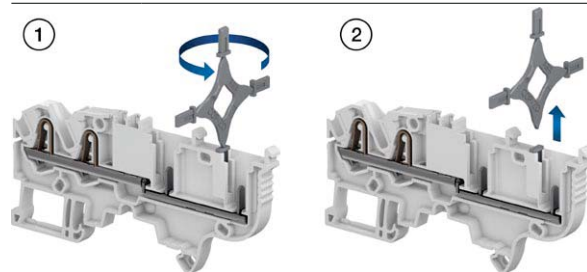

1SNK160315V0014

VR

9.4 mm 0.370 in spacing

VR locking devices

Description

- Automatic locking providing excellent plug withstand in case of accidental pulling,
- Lock safely one or two CDK or CDS plugs on ZDK and ZDS pluggable terminal blocks,
- Install one VR... up to 8 poles plugs assembly and two VR... up to 15 poles assembly.

Ordering details

Description	Color	Type	Part Number	Pkg qty	Weight (1 pce)
9.4 mm 0.370 in spacing	Black	VR-ZD	1SNK900637R0000	50	6.5

Main technical data

Material specifications	Insulating material	Polyacetal	
	Flammability	HB	
	NF F 16 101		
Ambient temperature min/max	Service IEC 60068-2-1	-55 ... +110 °C	-67 ... +230 °F
	Storage	-55 ... +110 °C	-67 ... +230 °F
	Installing	-5 ... +40 °C	+23 ... +104 °F

All the main technical data provided are "manufacturer" values.

RoHS

Mounting instructions



Technical data valid for copper conductors only.

1SNK164009S0201



Index

Part Number classification

Part Number	Type	Page	Part Number	Type	Page	Part Number	Type	Page
1SNA007865R2600	FC2	110	1SNA173449R0700	BJH14-5	192	1SNA199393R2200	SCH6	192
1SNA103007R2300	PE	211	1SNA173451R2100	BJH14-10	192	1SNA199394R2300	INH3	192
1SNA103098R2600	SSB20	216	1SNA173452R2200	BJH18-2	192	1SNA199400R0600	FEHD1	147
1SNA103099R2700	SSB20T	216	1SNA173453R2300	BJH18-3	192	1SNA199411R1400	FJH501	153
1SNA113542R1000	PC5-2	253	1SNA173454R2400	BJH18-4	192	1SNA199412R1500	SCH8	153
1SNA113544R1200	PC5-10	253	1SNA173460R0600	BJH18-5	192	1SNA199551R2000	SCAD5	110
1SNA114205R2000	AD2.5	214	1SNA173461R2300	BJH18-10	192	1SNA205392R0700	HD4/9.F4.2	177
1SNA116538R1700	PC8-2	341	1SNA173523R1100	PC81-10	268	1SNA205396R0300	HD10/12.F5.2	181
1SNA116539R1000	PC8-3	341	1SNA173627R2100	EL6	111	1SNA205424R2700	FJHD40	181
1SNA116540R2500	PC8-4	341	1SNA174300R1700	PR3.Z2	310	1SNA205427R2200	INH1	177
1SNA116900R2700	BADH	117	1SNA174784R2000	BJS6-20	111	1SNA205428R0300	SCHD1	177
1SNA160487R2500	HD2.5/6.2G.2G.1	144	1SNA176278R1600	BJM15-2	110	1SNA205429R0400	SCHD2	181
1SNA160563R0000	HD6/9.3G.2G	151	1SNA176279R1700	BJM15-3G	110	1SNA205431R2600	FJHD32	177
1SNA160564R0100	HD6/9.2G.3G	152	1SNA176280R0500	BJM15-4	110	1SNA205767R1600	DRF6	196
1SNA160606R1400	HD6/8.2G.2G.1	145	1SNA176281R2200	BJM15-5	110	1SNA205768R2700	DRF8	197
1SNA160619R1000	HD6/8.2G.2G.2	146	1SNA176282R2300	BJM15-10	110	1SNA205769R2000	DRF10	198
1SNA160621R0200	HD6/9.5G	150	1SNA176663R0000	BJM16-2	111	1SNA205770R2500	DRF12	199
1SNA162309R1000	HD6/14.DG	158	1SNA176664R0100	BJM16-3	111	1SNA205771R1200	DRF16	200
1SNA162315R2500	HD6/14.SF.2G.2G	155	1SNA176665R0200	BJM16-4	111	1SNA205772R1300	BJS27-2	196
1SNA162971R2700	HD6/14.DH	157	1SNA176666R0300	BJM16-5	111	1SNA205773R1400	BJS27-3	196
1SNA162972R2000	HD6/14.SDH	161	1SNA176667R0400	BJM16-10	111	1SNA205774R1500	BJS32-2	197
1SNA162979R0700	HD16/14.FF5.20	195	1SNA176669R1600	BJM18-2	112	1SNA205775R1600	BJS32-3	197
1SNA162988R2100	HD6/14.SDH.1	160	1SNA176670R1300	BJM18-3	112	1SNA205776R1700	BJS42-2	198
1SNA162991R1400	HD16/14.FF5.21	194	1SNA176671R0000	BJM18-4	112	1SNA205777R1000	BJS42-3	198
1SNA163043R2100	AL2	110	1SNA176672R0100	BJM18-5	112	1SNA205778R2100	BJS51-2	199
1SNA163155R2600	REH3	190	1SNA176673R0200	BJM18-10	112	1SNA205779R2200	BJS51-3	199
1SNA163156R2700	RTC	153	1SNA178430R0500	RCPEB	316	1SNA206053R0700	BJM131.2	239
1SNA163261R0000	AL3	110	1SNA178431R2200	EPR1	316	1SNA206054R0000	BJM131.3	239
1SNA163313R2400	PC8-10	303	1SNA178529R0400	PR50	311	1SNA206126R2500	BJM136.2	240
1SNA163350R1500	PRH2R	313	1SNA178745R1400	CBM5	110	1SNA206223R0600	BJM136.3	240
1SNA163468R0000	BJH131-10	179	1SNA178746R1500	CBM8	110	1SNA206680R1500	AJS9-BK	302
1SNA163475R2700	BJH17	182	1SNA178944R0400	OUPAD	110	1SNA206681R0200	AJS9-GN	302
1SNA163476R2000	BJH23-10	184	1SNA179371R1600	CN5	268	1SNA206682R0300	AJS9-GR	302
1SNA163479R0300	BJH311	186	1SNA179466R0600	OUMAD	110	1SNA206683R0400	AJS9-BL	302
1SNA163497R1600	PEFH	153	1SNA179726R0200	AJS9	300	1SNA206720R1400	AJS9-RD	302
1SNA163503R2400	BJH105	176	1SNA187312R1400	CPM	153	1SNA206721R0100	AL4-M3	300
1SNA163518R2200	RPED	153	1SNA190001R2000	D35/27.FF	196	1SNA206765R0000	AJS9-WH	302
1SNA164519R2400	BAR	211	1SNA190002R2100	D70/32.FF	197	1SNA206772R0000	AJS9-PR	302
1SNA164655R0400	BAH22	153	1SNA190003R2200	D120/42.FF	198	1SNA206782R0000	AJS9-BR	302
1SNA164800R0300	PR3.G2	311	1SNA190004R2300	D185/55.FF	199	1SNA230000R1200	RC55	110
1SNA167224R2700	BJS13-10	190	1SNA190005R2400	D300/55.FF	200	1SNA231000R0700	RC510	110
1SNA167489R2200	BAH21	176	1SNA190016R1600	CPUF35	196	1SNA232000R0000	RC65	111
1SNA167735R2700	VSJ6	144	1SNA190017R1700	CPUF70	197	1SNA233000R0100	RC610	111
1SNA167860R0100	FC4	112	1SNA190018R2000	CPUF120	198	1SNA234000R0200	RC810	112
1SNA168355R1300	BAH24	144	1SNA190019R2100	CPUF185	199	1SNA235106R2600	PAM43020	345
1SNA168356R1400	BJH8-10	145	1SNA190305R0500	HD2.5/6.3.2G.2G.1	166	1SNA235155R2600	PIB2-TT	316
1SNA168357R1500	BJH9-10	145	1SNA190312R2300	HD2.5/6.3.2G.2G.1.GG	163	1SNA235157R2000	PIB2-TT-YL	316
1SNA168456R0100	BJH8-2	145	1SNA190314R2500	HD2.5/6.3.GG1.2G.2G	164	1SNA235158R0100	RCPEAD-TT	316
1SNA168457R0200	BJH8-3	145	1SNA190316R2700	HD2.5/6.3.3G.3G.1	162	1SNA235159R0200	RCPEAD-TT-YL	316
1SNA168458R1300	BJH8-4	145	1SNA190468R0000	E4/6	211	1SNA235510R0800	M-W810PC	202
1SNA168459R1400	BJH8-5	145	1SNA190607R0400	E6/8	212	1SNA235511R0600	M-W610PC	201
1SNA168460R1100	BJH9-2	145	1SNA191296R1100	E10/16.S	216	1SNA235512R1000	M-W1010PC	203
1SNA168461R0600	BJH9-3	145	1SNA191302R2700	E10/16	213	1SNA238000R1600	RC1010	239
1SNA168462R0700	BJH9-4	145	1SNA193080R1200	FEE6-1	211	1SNA290451R0300	BJE762.2	119
1SNA168463R0000	BJH9-5	145	1SNA193085R0300	FEE8-2	212	1SNA290452R0400	BJE762.5	119
1SNA168481R2300	BJS61-2	144	1SNA193137R0300	FEMT1	214	1SNA290453R0500	BJE762.10	119
1SNA168482R2400	BJS61-3	144	1SNA193449R2400	FEE10-16	213	1SNA290454R0600	EIP	119
1SNA168483R2500	BJS61-4	144	1SNA193878R2200	FEH4	146	1SNA290455R0700	RB-12W7	119
1SNA168484R2600	BJS61-5	144	1SNA195212R1000	M6/8.STP	214	1SNA295011R1600	HD10/12.F5.3	179
1SNA168485R2700	BJS61-10	144	1SNA196792R1700	BNSTP1	214	1SNA295012R1700	HD16/14.FF5.21.3	192
1SNA168486R2000	BJH7-2	144	1SNA196853R1400	BNC62	115	1SNA295013R1000	HD16/14.FF5.20.3	193
1SNA168487R2100	BJH7-3	144	1SNA196854R1500	BNSV62	115	1SNA295014R1100	HD6/13.FF4	190
1SNA168490R0000	BJH7-10	144	1SNA196896R0000	SCAD	111	1SNA295015R1200	HD6/30.F12G	154
1SNA168497R2300	PC	213	1SNA196915R0200	BIE	216	1SNA295298R0300	HD4/10.F4.19	178
1SNA168500R1200	PR4	312	1SNA196924R0300	BNF52	116	1SNA295391R2000	HD4/9.F4	176
1SNA168672R1100	TGA8	268	1SNA196926R0500	BNCT82	116	1SNA295392R2100	HD4/9.F4.2	177
1SNA168673R1200	TGA8	268	1SNA196927R0600	BNSV82	116	1SNA295393R2200	HD4/9.FF4	189
1SNA168674R1300	TGA8	268	1SNA196998R1600	BNF652	115	1SNA295394R2300	HD10/12.F5	180
1SNA168675R1400	ANT	268	1SNA197312R1600	CPM	153	1SNA295395R2400	HD10/12.F5.1	181
1SNA168700R2200	PR5	312	1SNA198352R0700	FEH3	144	1SNA295396R2500	HD10/12.F5.2	181
1SNA168949R1700	FEHD2	162	1SNA198549R0500	FEH9	155	1SNA295397R2600	HD10/12.FF5	191
1SNA171018R2000	EXBN2	115	1SNA198692R2500	SCH3	144	1SNA295398R0700	HD35/16.F6.19	182
1SNA173220R0500	PR30	310	1SNA198729R0100	FEH8	158	1SNA295399R0000	HD35/16.F6.19.1	183
1SNA173241R0600	RDJ6	144	1SNA199025R1400	HD2.5/6.3.GG.1.2GG	165	1SNA295400R0600	HD70/22.F8.31	184
1SNA173438R2400	BJH14-2	192	1SNA199096R1400	HD2.5/6.3.GH.2G.H	167	1SNA295401R2300	HD70/22.F8.31.1	185
1SNA173439R2500	BJH14-3	192	1SNA199320R0400	COCF	128	1SNA295402R2400	HD70/22.F8.31.2	185
1SNA173441R2700	BJH14-4	192	1SNA199321R2100	COCE	119	1SNA295403R2500	HD120/30.F10.31.1	187

Index

Part Number classification

Part Number	Type	Page	Part Number	Type	Page	Part Number	Type	Page
1SNA295405R2700	HD185/36.F12.31.1	188	1SNA519200R0000	CS-RGW-S	201	1SNK506211R0000	ZS6-D1	287
1SNA295424R1100	FJHD40	178	1SNA519201R0000	CS-RGW-L	203	1SNK506212R0000	ZS6-D2-PE	288
1SNA295425R1200	FJHD50	191	1SNB041090R0510	MG-CPM-01 41090	201	1SNK506213R0000	ZS4-T3-R1	295
1SNA295426R1300	FJHD	178	1SNB041096R0810	MG-CPM-01 41096	202	1SNK506214R0000	ZS6-D1-RD	287
1SNA295427R1400	INHDI	176	1SNB041790R0512	MG-CPM 13 41790	19	1SNK506220R0000	ZS6-D2-BL	286
1SNA295428R2500	SCHD1	176	1SNB041791R0612	MG-CPM 13 41791	28	1SNK506230R0000	ZS6-D2-OR	286
1SNA295429R2600	SCHD2	178	1SNB043196R0012	MG-CPMFA 43196	93	1SNK506250R0000	ZS6-D1-PE	286
1SNA295430R2300	SCHD5	191	1SNB045194R1735	MG-TAR 45194	316	1SNK506260R0000	ZS6-D2-YL	286
1SNA295431R1000	FJHD32	176	1SNB045490R8530	MG-TAR 45490	316	1SNK506262R0000	ZS6-D2-RD	286
1SNA295448R0100	HD120/30.F10.31	186	1SNB046415R0615	MG-VYT 46415	332	1SNK506265R0000	ZS6-D2-WH	286
1SNA296351R0000	BAM2	110	1SNB046915R0615	MG-VYT 46915	332	1SNK506266R0000	ZS6-D2-BK	286
1SNA399726R0700	EPR2	316	1SNB049148R1735	MG-TAA 49148	316	1SNK506310R0000	ZS4-S-R1	255
1SNA399730R1700	D1.5/6.ADO.NF	111	1SNB049198R1735	MG-TAA 49198	316	1SNK506311R0000	ZS4-S-T2-R1	256
1SNA399736R0100	D2.5/8.ADO.NF	112	1SNB049448R8530	MG-TAA 49448	316	1SNK506312R0000	ZS4-S-T2.3-R1	256
1SNA399742R1700	D1.5/6.D2.ADO.NF	117	1SNB049498R8530	MG-TAA 49498	316	1SNK506313R0000	ZS4-SP-R1	262
1SNA399748R2500	D4/8.ADO.NF	114	1SNK140000R0000	MC512	19	1SNK506314R0000	ZS4-SP-T2-R1	263
1SNA399749R2600	D2.5/8.ADO.NF1	113	1SNK149999R0000	MC812PA	19	1SNK506315R0000	ZS6-S	257
1SNA399752R1100	D2.5/8.S.ADO.NF	116	1SNK150000R0000	MC612	22	1SNK506316R0000	ZS6-S-4S-T2	258
1SNA399787R0500	CPBP2	240	1SNK159999R0000	MC612PA	22	1SNK506320R0000	ZS4-S-R1-BL	255
1SNA399788R1600	CPBP1	239	1SNK160000R0000	MC812	28	1SNK506321R0000	ZS4-S-T2-R1-BL	256
1SNA399802R0500	FEMAD3	110	1SNK169999R0000	MC812PA	28	1SNK506322R0000	ZS6-S-BL	257
1SNA399803R0600	FED2AD2	117	1SNK505010R0000	ZS4	228	1SNK506330R0000	ZS4-S-R1-OR	255
1SNA399804R0700	FEDAD5	115	1SNK505020R0000	ZS4-BL	228	1SNK506331R0000	ZS4-S-T2-R1-OR	256
1SNA399916R2600	D1.5/6.ADO.D2.NF	118	1SNK505030R0000	ZS4-OR	228	1SNK506410R0000	ZS4-SF	274
1SNA399963R0500	HD6/24.DH	156	1SNK505060R0000	ZS4-YL	228	1SNK506411R0000	ZS4-SF-T2	275
1SNA399964R0600	HD6/24.DH	156	1SNK505061R0000	ZS4-GN	228	1SNK506412R0000	ZS4-SF-R1	276
1SNA400014R2700	ES8-CG	215	1SNK505062R0000	ZS4-RD	228	1SNK506413R0000	ZS4-SF-R2	277
1SNA400015R2000	ES8-CG	215	1SNK505063R0000	ZS4-PR	228	1SNK506414R0000	ZS4-S-R2	280
1SNA400018R0300	FECPE.2ADO	121	1SNK505064R0000	ZS4-BR	228	1SNK506415R0000	ZS4-SF-R3	276
1SNA400019R0400	FECPE.ADO	119	1SNK505065R0000	ZS4-WH	228	1SNK506416R0000	ZS4-SF-R4	277
1SNA400061R0600	D2.5/7.ADO-CPE.NF	122	1SNK505066R0000	ZS4-BK	228	1SNK508010R0000	ZS10	232
1SNA400062R0700	D2.5/7.2ADO-CPE.NF	123	1SNK505150R0000	ZS4-PE	228	1SNK508011R0000	ZS10-R1	300
1SNA400063R0000	VRADO.CPE7	119	1SNK505210R0000	ZS4-D2	284	1SNK508013R0000	ZS4-R1	272
1SNA400083R2500	D1.5/6.S.ADO.NF	115	1SNK505211R0000	ZS4-D1	285	1SNK508020R0000	ZS10-BL	232
1SNA400142R0400	BNSV62-1	115	1SNK505212R0000	ZS4-T3	294	1SNK508030R0000	ZS10-OR	232
1SNA400153R0700	D1.5/7.ADO-CPE.NF	119	1SNK505214R0000	ZS4-D-CH-UD	296	1SNK508060R0000	ZS10-YL	232
1SNA400154R0000	D1.5/7.2ADO-CPE.NF	121	1SNK505215R0000	ZS4-D-CH-DU	297	1SNK508061R0000	ZS10-GN	232
1SNA400156R0200	D2.5/7.ADO-CPE.NF1	120	1SNK505220R0000	ZS4-D2-BL	284	1SNK508062R0000	ZS10-RD	232
1SNA400240R2200	D4/7.ADO-CPE.NF	124	1SNK505230R0000	ZS4-D2-OR	284	1SNK508063R0000	ZS10-PR	232
1SNA400241R1700	D4/7.2ADO-CPE.NF	125	1SNK505310R0000	ZS4-S	253	1SNK508064R0000	ZS10-BR	232
1SNA400315R0100	D1.5/5.ADO.NF	110	1SNK505311R0000	ZS4-S-T2	254	1SNK508065R0000	ZS10-WH	232
1SNA400703R1700	D2.5/7.2CPE	126	1SNK505312R0000	ZS4-S-T2.3	254	1SNK508066R0000	ZS10-BK	232
1SNA400704R1000	D2.5/7.CPE.CPE	127	1SNK505313R0000	ZS4-SP	260	1SNK508150R0000	ZS10-PE	232
1SNA400708R2400	FECPE	126	1SNK505314R0000	ZS4-SP-T2	261	1SNK508151R0000	ZS10-PE-R1	301
1SNA400711R0600	PC8-R1	301	1SNK505315R0000	ZS4-D2-S	290	1SNK508310R0000	ZS10-ST	302
1SNA400712R0700	PC8-R2	303	1SNK505316R0000	ZS4-D2-S-T2	291	1SNK508311R0000	ZS10-ST-T4	300
1SNA400713R0000	PC8-R3	303	1SNK505320R0000	ZS4-S-BL	253	1SNK508312R0000	ZS10-ST-1	300
1SNA400724R0300	PC8-R4	303	1SNK505321R0000	ZS4-S-T2-BL	254	1SNK508315R0000	ZS10-S	259
1SNA400766R1500	HD6/7.5G	147	1SNK505330R0000	ZS4-S-OR	253	1SNK508316R0000	ZS10-SP	264
1SNA400767R1600	HD6/7.3G.2G	148	1SNK505331R0000	ZS4-S-T2-OR	254	1SNK508320R0000	ZS10-S-BL	259
1SNA400768R2700	HD6/7.2G.3G	149	1SNK505910R0000	ES4	228	1SNK508410R0000	ZS4-SF1	268
1SNA400782R0000	HD6/22.F12G	153	1SNK505911R0000	ES6-4S	231	1SNK508411R0000	ZS4-SF1-T2	269
1SNA400799R0000	FESDH	159	1SNK505912R0000	ES6-3S	230	1SNK508412R0000	ZS4-SF1-R1	270
1SNA400800R0000	HD6/9.SDH.1	159	1SNK505960R0000	ES4-D2	284	1SNK508413R0000	ZS4-SF1-R2	271
1SNA400842R0000	PC8-R5	303	1SNK505961R0000	ES4-T3	294	1SNK508414R0000	ZS4-SF1-R3	270
1SNA400843R0000	PC8-R6	303	1SNK506010R0000	ZS6	229	1SNK508415R0000	ZS4-SF1-R4	271
1SNA400849R0000	PC8-R7	303	1SNK506011R0000	ZS6-3S	230	1SNK508416R0000	ZS4-S-R3	273
1SNA400850R0000	PC8-R8	303	1SNK506012R0000	ZS6-4S	231	1SNK508417R0000	ZS10-S-R2	283
1SNA510003R0000	RGW2.5-V0	201	1SNK506013R0000	ZS4-R2	278	1SNK508418R0000	ZS10-SF	281
1SNA510005R0000	RGW25-M5-V0	203	1SNK506020R0000	ZS6-BL	229	1SNK508419R0000	ZS4-S-R3-T2	273
1SNA510006R0000	RGW25-M6-V0	204	1SNK506021R0000	ZS6-3S-BL	230	1SNK508421R0000	ZS10-SF-R1	282
1SNA510024R0000	RGW6-V0	202	1SNK506022R0000	ZS6-4S-BL	231	1SNK508422R0000	ZS10-SF-R3	282
1SNA511003R0500	RGW2.5-PE-V0	201	1SNK506030R0000	ZS6-OR	229	1SNK508423R0000	ZS4-D2-SF1-R1	293
1SNA511024R0500	RGW6-PE-V0	202	1SNK506060R0000	ZS6-YL	229	1SNK508424R0000	ZS4-D2-SF1-R3	293
1SNA519003R0000	E-RGW2.5	201	1SNK506061R0000	ZS6-GN	229	1SNK508425R0000	ZS4-D2-SF1	292
1SNA519004R0000	E-RGW6	202	1SNK506062R0000	ZS6-RD	229	1SNK508430R0000	ZS4-SF1-OR	268
1SNA519005R0000	E-RGW25	203	1SNK506063R0000	ZS6-PR	229	1SNK508910R0000	ES10-ST	300
1SNA519103R0200	PC-RG2.5-2	201	1SNK506064R0000	ZS6-BR	229	1SNK508911R0000	ES4-D2-SF1	292
1SNA519103R0300	PC-RG2.5-3	201	1SNK506065R0000	ZS6-WH	229	1SNK508960R0000	ES4-SF	268
1SNA519103R0400	PC-RG2.5-4	201	1SNK506066R0000	ZS6-BK	229	1SNK510010R0000	ZS16	233
1SNA519103R1000	PC-RG2.5-10	201	1SNK506067R0000	ZS6-3S-YL	230	1SNK510020R0000	ZS16-BL	233
1SNA519104R0200	PC-RG6-2	202	1SNK506068R0000	ZS6-4S-YL	231	1SNK510030R0000	ZS16-OR	233
1SNA519104R0300	PC-RG6-3	202	1SNK506150R0000	ZS6-PE	229	1SNK510150R0000	ZS16-PE	233
1SNA519104R0400	PC-RG6-4	202	1SNK506151R0000	ZS6-3S-PE	230	1SNK512010R0000	ZS25	234
1SNA519104R0700	PC-RG6-7	202	1SNK506152R0000	ZS6-4S-PE	231	1SNK512020R0000	ZS25-BL	234
1SNA519104R1000	PC-RG6-10	202	1SNK506153R0000	ZS4-PE-R2	279	1SNK512060R0000	ZS25-YL	234
1SNA519106R0200	PC-RG25-2	203	1SNK506210R0000	ZS6-D2	286	1SNK512150R0000	ZS25-PE	234



Index

Part Number classification

Part Number	Type	Page	Part Number	Type	Page	Part Number	Type	Page
1SNK516010R0000	ZS35	235	1SNK705912R0000	EK2.5-4P	21	1SNK805715R0000	CDS4-E	98
1SNK516011R0000	ZS50	236	1SNK705913R0000	EK2.5-S-4P	48	1SNK805738R0000	CDK2.5-J	94
1SNK516020R0000	ZS35-BL	235	1SNK705960R0000	EK2.5-D2	54	1SNK805739R0000	CDK2.5-J-E	94
1SNK516021R0000	ZS50-BL	236	1SNK705961R0000	EK2.5-T3	58	1SNK805740R0000	CDK2.5-2P-J	95
1SNK516030R0000	ZS35-OR	235	1SNK706010R0000	ZK4	22	1SNK805741R0000	CDK2.5-2P-J-E	95
1SNK516060R0000	ZS50-YL	236	1SNK706011R0000	ZK4-3P	23	1SNK805742R0000	CDK2.5-BL	83
1SNK516063R0000	ZS50-RD	236	1SNK706012R0000	ZK4-4P	24	1SNK805743R0000	CDK2.5-BL-E	83
1SNK516064R0000	ZS50-BK	236	1SNK706020R0000	ZK4-BL	22	1SNK805744R0000	CDK2.5-J-BL	94
1SNK516150R0000	ZS35-PE	235	1SNK706021R0000	ZK4-3P-BL	23	1SNK805745R0000	CDK2.5-J-BL-E	94
1SNK516151R0000	ZS50-PE	236	1SNK706022R0000	ZK4-4P-BL	24	1SNK805746R0000	CDK2.5-2P-J-BL	95
1SNK516170R0000	ZS35-PEN	249	1SNK706030R0000	ZK4-OR	22	1SNK805747R0000	CDK2.5-2P-J-BL-E	95
1SNK522010R0000	ZS70	237	1SNK706031R0000	ZK4-3P-OR	23	1SNK805748R0000	CDK2.5-J-PE	94
1SNK522020R0000	ZS70-BL	237	1SNK706032R0000	ZK4-4P-OR	24	1SNK805749R0000	CDK2.5-J-PE-E	94
1SNK522060R0000	ZS70-YL	237	1SNK706060R0000	ZK4-YL	22	1SNK805750R0000	CDK2.5-PE	82
1SNK522150R0000	ZS70-PE	237	1SNK706062R0000	ZK4-RD	22	1SNK805751R0000	CDK2.5-2P-J-PE	95
1SNK526010R0000	ZS95	238	1SNK706066R0000	ZK4-BK	22	1SNK805752R0000	CDK2.5-2P-J-PE-E	95
1SNK526020R0000	ZS95-BL	238	1SNK706150R0000	ZK4-PE	22	1SNK805753R0000	CDK2.5-PE-E	82
1SNK526060R0000	ZS95-YL	238	1SNK706151R0000	ZK4-PE-3P	23	1SNK805910R0000	EDK2.5-22	85
1SNK526150R0000	ZS95-PE	238	1SNK706152R0000	ZK4-PE-4P	24	1SNK805911R0000	EDS4-22	98
1SNK531010R0000	ZS150	239	1SNK706310R0000	ZK2.5-S-R1	49	1SNK805913R0000	EDK2.5-D	89
1SNK531020R0000	ZS150-BL	239	1SNK706410R0000	ZK2.5-SF	49	1SNK805914R0000	EDK2.5-21	84
1SNK531060R0000	ZS150-YL	239	1SNK706411R0000	ZK2.5-SF-R1	53	1SNK805915R0000	EDK2.5-11	80
1SNK536010R0000	ZS240	240	1SNK706412R0000	ZK2.5-SF-R3	53	1SNK805917R0000	ED2.5-22	81
1SNK536020R0000	ZS240-BL	240	1SNK708010R0000	ZK6	25	1SNK806010R0000	ZDK4-22	86
1SNK536060R0000	ZS240-YL	240	1SNK708011R0000	ZK6-3P	26	1SNK806013R0000	ZDS4-22-R1	100
1SNK705010R0000	ZK2.5	19	1SNK708020R0000	ZK6-BL	25	1SNK806712R0000	CDK4	86
1SNK705011R0000	ZK2.5-3P	20	1SNK708021R0000	ZK6-3P-BL	26	1SNK806713R0000	CDK4-E	86
1SNK705012R0000	ZK2.5-4P	21	1SNK708030R0000	ZK6-OR	25	1SNK806714R0000	CDS4-R1	100
1SNK705020R0000	ZK2.5-BL	19	1SNK708031R0000	ZK6-3P-OR	26	1SNK900001R0000	BAM4	201
1SNK705021R0000	ZK2.5-3P-BL	20	1SNK708060R0000	ZK6-YL	25	1SNK900002R0000	BAZ1	28
1SNK705022R0000	ZK2.5-4P-BL	21	1SNK708062R0000	ZK6-RD	25	1SNK900101R0000	CS	228
1SNK705030R0000	ZK2.5-OR	19	1SNK708066R0000	ZK6-BK	25	1SNK900102R0000	BAZH1	203
1SNK705031R0000	ZK2.5-3P-OR	20	1SNK708150R0000	ZK6-PE	25	1SNK900103R0000	CS-R1	228
1SNK705032R0000	ZK2.5-4P-OR	21	1SNK708151R0000	ZK6-PE-3P	26	1SNK900104R0000	ES-TC8	25
1SNK705060R0000	ZK2.5-YL	19	1SNK708911R0000	EK6-3P	26	1SNK900105R0000	ES-TC6	22
1SNK705061R0000	ZK2.5-GN	19	1SNK710010R0000	ZK10	27	1SNK900106R0000	CS-R2	19
1SNK705062R0000	ZK2.5-RD	19	1SNK710011R0000	ZK10-3P	29	1SNK900107R0000	CS-R3	28
1SNK705065R0000	ZK2.5-WH	19	1SNK710020R0000	ZK10-BL	27	1SNK900200R0000	TC5	19
1SNK705066R0000	ZK2.5-BK	19	1SNK710021R0000	ZK10-3P-BL	29	1SNK900201R0000	TC5-R1	19
1SNK705067R0000	ZK2.5-3P-YL	20	1SNK710030R0000	ZK10-OR	27	1SNK900203R0000	TP2	28
1SNK705068R0000	ZK2.5-3P-GN	20	1SNK710063R0000	ZK10-PV	28	1SNK900205R0000	TP4	28
1SNK705069R0000	ZK2.5-3P-RD	20	1SNK710064R0000	ZK10-3P-PV	30	1SNK900401R0000	PG5	50
1SNK705072R0000	ZK2.5-3P-WH	20	1SNK710065R0000	ZK10-PV-BL	28	1SNK900402R0000	PG5-R1	50
1SNK705073R0000	ZK2.5-3P-BK	20	1SNK710067R0000	ZK10-3P-PV-BL	30	1SNK900403R0000	PG5-R2	326
1SNK705074R0000	ZK2.5-4P-YL	21	1SNK710150R0000	ZK10-PE	28	1SNK900600R0000	SHBS	228
1SNK705075R0000	ZK2.5-4P-GN	21	1SNK710151R0000	ZK10-PE-3P	30	1SNK900601R0000	SHBP	19
1SNK705076R0000	ZK2.5-4P-RD	21	1SNK710910R0000	EK10	27	1SNK900602R0000	SHB	54
1SNK705079R0000	ZK2.5-4P-WH	21	1SNK710911R0000	EK10-3P	29	1SNK900603R0000	JB85-3	19
1SNK705080R0000	ZK2.5-4P-BK	21	1SNK712010R0000	ZK16	31	1SNK900604R0000	CO	303
1SNK705150R0000	ZK2.5-PE	19	1SNK712011R0000	ZK16-3P	33	1SNK900605R0000	LH	314
1SNK705151R0000	ZK2.5-PE-3P	20	1SNK712020R0000	ZK16-BL	31	1SNK900606R0000	LH-J	54
1SNK705152R0000	ZK2.5-PE-4P	21	1SNK712021R0000	ZK16-3P-BL	33	1SNK900607R0000	LH-R1	314
1SNK705210R0000	ZK2.5-D2	54	1SNK712063R0000	ZK16-PV	32	1SNK900611R0000	UMH	28
1SNK705211R0000	ZK2.5-D1	55	1SNK712064R0000	ZK16-3P-PV	34	1SNK900618R0000	PL5	228
1SNK705212R0000	ZK2.5-D2-PE	56	1SNK712065R0000	ZK16-PV-BL	32	1SNK900619R0000	PL6	229
1SNK705213R0000	ZK2.5-D-CH-UD	65	1SNK712067R0000	ZK16-3P-PV-BL	34	1SNK900620R0000	PL8	232
1SNK705214R0000	ZK2.5-D-CH-DU	66	1SNK712150R0000	ZK16-PE	32	1SNK900621R0000	PL10	233
1SNK705219R0000	ZK2.5-D-CH2-DU-RL	67	1SNK712151R0000	ZK16-PE-3P	34	1SNK900622R0000	PL16	235
1SNK705220R0000	ZK2.5-D2-BL	54	1SNK805010R0000	ZDK2.5-22	85	1SNK900624R0000	KCO	303
1SNK705250R0000	ZK2.5-D1-PE	54	1SNK805013R0000	ZDS4-22	98	1SNK900625R0000	PT-3	325
1SNK705310R0000	ZK2.5-S	47	1SNK805014R0000	ZDK2.5-21	84	1SNK900627R0000	RILS	334
1SNK705311R0000	ZK2.5-SP	50	1SNK805015R0000	ZDK2.5-11	83	1SNK900630R0000	MCLH	316
1SNK705312R0000	ZK2.5-S-4P	48	1SNK805016R0000	ZD2.5-11	80	1SNK900631R0000	MCLH-R1	316
1SNK705313R0000	ZK2.5-S-4P	51	1SNK805017R0000	ZD2.5-22	81	1SNK900633R0000	MCLH-YL	316
1SNK705320R0000	ZK2.5-S-BL	47	1SNK805020R0000	ZDK2.5-22-BL	85	1SNK900634R0000	MCLH-R1-YL	316
1SNK705321R0000	ZK2.5-S-4P-BL	48	1SNK805025R0000	ZDK2.5-11-BL	83	1SNK900636R0000	COP-ZD	80
1SNK705330R0000	ZK2.5-S-OR	47	1SNK805150R0000	ZDK2.5-11-PE	87	1SNK900637R0000	VR-ZD	93
1SNK705331R0000	ZK2.5-S-4P-OR	48	1SNK805152R0000	ZDK2.5-22-PE	88	1SNK900640R0000	TO3.5-50	328
1SNK705510R0000	ZK2.5-T3	58	1SNK805156R0000	ZD2.5-22-PE	82	1SNK900641R0000	TO4-100	328
1SNK705511R0000	ZK2.5-T1	59	1SNK805212R0000	ZDK2.5-D2-PE	91	1SNK900642R0000	TO5.5-125	328
1SNK705512R0000	ZK2.5-L-L-PE	60	1SNK805213R0000	ZDK2.5-D2	89	1SNK900643R0000	TO6.5-150	328
1SNK705513R0000	ZK2.5-L-N-PE	61	1SNK805214R0000	ZDK2.5-D1	90	1SNK900644R0000	TO3.5-100-INS	328
1SNK705550R0000	ZK2.5-T1-PE	58	1SNK805223R0000	ZDK2.5-D2-BL	89	1SNK900650R0000	PS-3	328
1SNK705710R0000	ZK2.5-CH-4P-LR	63	1SNK805250R0000	ZDK2.5-D1-PE	92	1SNK900652R0000	SC-JB8-2	300
1SNK705711R0000	ZK2.5-CH-4P-RL	64	1SNK805712R0000	CDK2.5	80	1SNK900653R0000	SC-JB8-3	304
1SNK705910R0000	EK2.5	19	1SNK805713R0000	CDK2.5-E	80	1SNK900654R0000	SC-JB8-4	304
1SNK705911R0000	EK2.5-3P	20	1SNK805714R0000	CDS4	98	1SNK900655R0000	SC-JB8-5	346

Index_1SNK160034C0201

Index

Part Number classification

Part Number	Type	Page	Part Number	Type	Page
1SNK900657R0000	SC-JB8-3-OR	346	1SSS267210R9800	FIC F.ADO.T2.B.10PNF	132
1SNK900658R0000	SC-JB8-4-OR	346	1SSS267216R9800	FIC F.ADO.T2.B.16PNF	132
1SNK900659R0000	TO3.5-50-A	328	1SSS276204R8800	FIC F.ADO.T3.4PNF	133
1SNK900660R0000	PT-ZD	93	1SSS276205R8800	FIC F.ADO.T3.5PNF	133
1SNK905302R0000	JB5-2	19	1SSS277202R8800	FIC F.ADO.T3-.2PNF	130
1SNK905303R0000	JB5-3	19	1SSS277203R8800	FIC F.ADO.T3-.3PNF	130
1SNK905304R0000	JB5-4	19	1SSS277204R8800	FIC F.ADO.T3-.4PNF	130
1SNK905305R0000	JB5-5	19	1SSS277205R8800	FIC F.ADO.T3-.5PNF	130
1SNK905310R0000	JB5-10	19	1SSS277206R8800	FIC F.ADO.T3-.6PNF	130
1SNK905350R0000	JB5-50	19	1SSS299253R2800	PT1	128
1SNK906302R0000	JB6-2	22	1SSS299254R2800	PT2	128
1SNK906303R0000	JB6-3	22	1SSS366202R4100	FIC M.ADO.T1.FI.2PNF	134
1SNK906304R0000	JB6-4	22	1SSS366203R4100	FIC M.ADO.T1.FI.3PNF	134
1SNK906305R0000	JB6-5	22	1SSS366204R4100	FIC M.ADO.T1.FI.4PNF	134
1SNK906310R0000	JB6-10	22	1SSS366205R4100	FIC M.ADO.T1.FI.5PNF	134
1SNK906350R0000	JB6-50	22	1SSS366206R4100	FIC M.ADO.T1.FI.6PNF	134
1SNK908302R0000	JB8-2	25	1SSS366208R4100	FIC M.ADO.T1.FI.8PNF	134
1SNK908303R0000	JB8-3	25	1SSS366210R4100	FIC M.ADO.T1.FI.10PNF	134
1SNK908304R0000	JB8-4	25	1SSS367202R4100	FIC M.ADO.T2.FI.2PNF	135
1SNK908305R0000	JB8-5	25	1SSS367203R4100	FIC M.ADO.T2.FI.3PNF	135
1SNK908310R0000	JB8-10	25	1SSS367204R4100	FIC M.ADO.T2.FI.4PNF	135
1SNK908902R0000	JB8-2-R1	302	1SSS367205R4100	FIC M.ADO.T2.FI.5PNF	135
1SNK908903R0000	JB8-3-R1	302	1SSS367206R4100	FIC M.ADO.T2.FI.6PNF	135
1SNK908904R0000	JB8-4-R1	302	1SSS367208R4100	FIC M.ADO.T2.FI.8PNF	135
1SNK908905R0000	JB8-5-R1	302	1SSS367210R4100	FIC M.ADO.T2.FI.10PNF	135
1SNK908910R0000	JB8-10-R1	302			
1SNK910302R0000	JB10-2	27			
1SNK910303R0000	JB10-3	27			
1SNK910304R0000	JB10-4	27			
1SNK910305R0000	JB10-5	27			
1SNK910310R0000	JB10-10	27			
1SNK912302R0000	JB12-2	28			
1SNK912303R0000	JB12-3	28			
1SNK912305R0000	JB12-5	28			
1SNK916302R0000	JB16-2	235			
1SNK916303R0000	JB16-3	235			
1SNK916304R0000	JB16-4	235			
1SNK916305R0000	JB16-5	235			
1SNK916310R0000	JB16-10	235			
1SNK922302R0000	JB22-2	237			
1SNK922303R0000	JB22-3	237			
1SNK922305R0000	JB22-5	237			
1SNK922310R0000	JB22-10	237			
1SNK926302R0000	JB26-2	238			
1SNK926303R0000	JB26-3	238			
1SNK926305R0000	JB26-5	238			
1SNK926310R0000	JB26-10	238			
1SSS266202R8800	FIC F.ADO.T1.2PNF	128			
1SSS266202R9800	FIC F.ADO.T1.B.2PNF	129			
1SSS266203R8800	FIC F.ADO.T1.3PNF	128			
1SSS266203R9800	FIC F.ADO.T1.B.3PNF	129			
1SSS266204R8800	FIC F.ADO.T1.4PNF	128			
1SSS266204R9800	FIC F.ADO.T1.B.4PNF	129			
1SSS266205R8800	FIC F.ADO.T1.5PNF	128			
1SSS266205R9800	FIC F.ADO.T1.B.5PNF	129			
1SSS266206R8800	FIC F.ADO.T1.6PNF	128			
1SSS266206R9800	FIC F.ADO.T1.B.6PNF	129			
1SSS266207R8800	FIC F.ADO.T1.7PNF	128			
1SSS266208R8800	FIC F.ADO.T1.8PNF	128			
1SSS266208R9800	FIC F.ADO.T1.B.8PNF	129			
1SSS266209R8800	FIC F.ADO.T1.9PNF	128			
1SSS266210R8800	FIC F.ADO.T1.10PNF	128			
1SSS266210R9800	FIC F.ADO.T1.B.10PNF	129			
1SSS267202R8800	FIC F.ADO.T2.2PNF	131			
1SSS267202R9800	FIC F.ADO.T2.B.2PNF	132			
1SSS267203R8800	FIC F.ADO.T2.3PNF	131			
1SSS267203R9800	FIC F.ADO.T2.B.3PNF	132			
1SSS267204R8800	FIC F.ADO.T2.4PNF	131			
1SSS267204R9800	FIC F.ADO.T2.B.4PNF	132			
1SSS267205R8800	FIC F.ADO.T2.5PNF	131			
1SSS267205R9800	FIC F.ADO.T2.B.5PNF	132			
1SSS267206R8800	FIC F.ADO.T2.6PNF	131			
1SSS267206R9800	FIC F.ADO.T2.B.6PNF	132			
1SSS267207R8800	FIC F.ADO.T2.7PNF	131			
1SSS267208R8800	FIC F.ADO.T2.8PNF	131			
1SSS267208R9800	FIC F.ADO.T2.B.8PNF	132			
1SSS267210R8800	FIC F.ADO.T2.10PNF	131			

Index

Type classification

Type	Part Number	Page	Type	Part Number	Page	Type	Part Number	Page
AD2.5	1SNA114205R2000	214	BJS32-2	1SNA205774R1500	197	D2.5/7.CPE.CPE	1SNA400704R1000	127
AJS9	1SNA179726R0200	300	BJS32-3	1SNA205775R1600	197	D2.5/8.ADO.NF	1SNA399736R0100	112
AJS9-BK	1SNA206680R1500	302	BJS42-2	1SNA205776R1700	198	D2.5/8.ADO.NF1	1SNA399749R2600	113
AJS9-BL	1SNA206683R0400	302	BJS42-3	1SNA205777R1000	198	D2.5/8.S.ADO.NF	1SNA399752R1100	116
AJS9-BR	1SNA206782R0000	302	BJS551-2	1SNA205778R2100	199	D300/55.FF	1SNA190005R2400	200
AJS9-GN	1SNA206681R0200	302	BJS551-3	1SNA205779R2200	199	D35/27.FF	1SNA190001R2000	196
AJS9-GR	1SNA206682R0300	302	BJS61-10	1SNA168485R2700	144	D4/7.2ADO.CPE.NF	1SNA400241R1700	125
AJS9-PR	1SNA206772R0000	302	BJS61-2	1SNA168481R2300	144	D4/7.ADO.CPE.NF	1SNA400240R2200	124
AJS9-RD	1SNA206720R1400	302	BJS61-3	1SNA168482R2400	144	D4/8.ADO.NF	1SNA399748R2500	114
AJS9-WH	1SNA206765R0000	302	BJS61-4	1SNA168483R2500	144	D70/32.FF	1SNA190002R2100	197
AL2	1SNA163043R2100	110	BJS61-5	1SNA168484R2600	144	DRF10	1SNA205769R2000	198
AL3	1SNA163261R0000	110	BJS6-20	1SNA174784R2000	111	DRF12	1SNA205770R2500	199
AL4-M3	1SNA206721R0100	300	BNCE2	1SNA196853R1400	115	DRF16	1SNA205771R1200	200
ANT	1SNA168675R1400	268	BNCT82	1SNA196926R0500	116	DRF6	1SNA205767R1600	196
BADH	1SNA116900R2700	117	BNF52	1SNA196924R0300	116	DRF8	1SNA205768R2700	197
BAH21	1SNA167489R2200	176	BNF652	1SNA196998R1600	115	E10/16	1SNA191302R2700	213
BAH22	1SNA164655R0400	153	BNSTP1	1SNA196792R1700	214	E10/16.S	1SNA191296R1100	216
BAH24	1SNA168355R1300	144	BNSV62	1SNA196854R1500	115	E4/6	1SNA190468R0000	211
BAM2	1SNA296351R0000	110	BNSV62-1	1SNA400142R0400	115	E6/8	1SNA190607R0400	212
BAM4	1SNK900001R0000	201	BNSV82	1SNA196927R0600	116	ED2.5-22	1SNK805917R0000	81
BAR	1SNA164519R2400	211	CBM5	1SNA178745R1400	110	EDK2.5-11	1SNK805915R0000	80
BAZ1	1SNK900002R0000	28	CBM8	1SNA178746R1500	110	EDK2.5-21	1SNK805914R0000	84
BAZH1	1SNK900102R0000	203	CDK2.5	1SNK805712R0000	80	EDK2.5-22	1SNK805910R0000	85
BIE	1SNA196915R0200	216	CDK2.5-2P-J	1SNK805740R0000	95	EDK2.5-D	1SNK805913R0000	89
BJE762.10	1SNA290453R0500	119	CDK2.5-2P-J-BL	1SNK805746R0000	95	EDS4-2	1SNK805911R0000	98
BJE762.2	1SNA290451R0300	119	CDK2.5-2P-J-BL-E	1SNK805747R0000	95	EIP	1SNA290454R0600	119
BJE762.5	1SNA290452R0400	119	CDK2.5-2P-J-E	1SNK805741R0000	95	EK10	1SNK710910R0000	27
BJH105	1SNA163503R2400	176	CDK2.5-2P-J-PE	1SNK805751R0000	95	EK10-3P	1SNK710911R0000	29
BJH131-10	1SNA163468R0000	179	CDK2.5-2P-J-PE-E	1SNK805752R0000	95	EK2.5	1SNK705910R0000	19
BJH14-10	1SNA173451R2100	192	CDK2.5-BL	1SNK805742R0000	83	EK2.5-3P	1SNK705911R0000	20
BJH14-2	1SNA173438R2400	192	CDK2.5-BL-E	1SNK805743R0000	83	EK2.5-4P	1SNK705912R0000	21
BJH14-3	1SNA173439R2500	192	CDK2.5-E	1SNK805713R0000	80	EK2.5-D2	1SNK705960R0000	54
BJH14-4	1SNA173441R2700	192	CDK2.5-J	1SNK805738R0000	94	EK2.5-S-4P	1SNK705913R0000	48
BJH14-5	1SNA173449R0700	192	CDK2.5-J-BL	1SNK805744R0000	94	EK2.5-T3	1SNK705961R0000	58
BJH17	1SNA163475R2700	182	CDK2.5-J-BL-E	1SNK805745R0000	94	EK6-3P	1SNK708911R0000	26
BJH18-10	1SNA173461R2300	192	CDK2.5-J-E	1SNK805739R0000	94	EL6	1SNA173627R2100	111
BJH18-2	1SNA173452R2200	192	CDK2.5-J-PE	1SNK805748R0000	94	EPR1	1SNA178431R2200	316
BJH18-3	1SNA173453R2300	192	CDK2.5-J-PE-E	1SNK805749R0000	94	EPR2	1SNA399726R0700	316
BJH18-4	1SNA173454R2400	192	CDK2.5-PE	1SNK805750R0000	82	E-RGW2.5	1SNA519003R0000	201
BJH18-5	1SNA173460R0600	192	CDK2.5-PE-E	1SNK805753R0000	82	E-RGW25	1SNA519005R0000	203
BJH23-10	1SNA163476R2000	184	CDK4	1SNK806712R0000	86	E-RGW6	1SNA519004R0000	202
BJH311	1SNA163479R0300	186	CDK4-E	1SNK806713R0000	86	ES10-ST	1SNK508910R0000	300
BJH7-10	1SNA168490R0000	144	CDS4	1SNK805714R0000	98	ES4	1SNK505910R0000	228
BJH7-2	1SNA168486R2000	144	CDS4-E	1SNK805715R0000	98	ES4-D2	1SNK505960R0000	284
BJH7-3	1SNA168487R2100	144	CDS4-R1	1SNK806714R0000	100	ES4-D2-SF1	1SNK508911R0000	292
BJH8-10	1SNA168356R1400	145	ON5	1SNA179371R1600	268	ES4-SF	1SNK508960R0000	268
BJH8-2	1SNA168456R0100	145	CO	1SNK900604R0000	303	ES4-T3	1SNK505961R0000	294
BJH8-3	1SNA168457R0200	145	COCE	1SNA199321R2100	119	ES6-3S	1SNK505912R0000	230
BJH8-4	1SNA168458R1300	145	COCF	1SNA199320R0400	128	ES6-4S	1SNK505911R0000	231
BJH8-5	1SNA168459R1400	145	COP-ZD	1SNK900636R0000	80	ES8-CG	1SNA400014R2700	215
BJH9-10	1SNA168357R1500	145	CPBP1	1SNA399788R1600	239		1SNA400015R2000	215
BJH9-2	1SNA168460R1100	145	CPBP2	1SNA399787R0500	240	ES-TC6	1SNK900105R0000	22
BJH9-3	1SNA168461R0600	145	CPM	1SNA187312R1400	153	ES-TC8	1SNK900104R0000	25
BJH9-4	1SNA168462R0700	145		1SNA197312R1600	153	EXBN2	1SNA171018R2000	115
BJH9-5	1SNA168463R0000	145	CPUF120	1SNA190018R2000	198	FC2	1SNA007865R2600	110
BJMI31.2	1SNA206053R0700	239	CPUF185	1SNA190019R2100	199	FC4	1SNA167860R0100	112
BJMI31.3	1SNA206054R0000	239	CPUF35	1SNA190016R1600	196	FE0PE	1SNA400708R2400	126
BJMI36.2	1SNA206126R2500	240	CPUF70	1SNA190017R1700	197	FE0PE.2ADO	1SNA400018R0300	121
BJMI36.3	1SNA206223R0600	240	CS	1SNK900101R0000	228	FE0PE.ADO	1SNA400019R0400	119
BJMI5-10	1SNA176282R2300	110	CS-R1	1SNK900103R0000	228	FED2AD2	1SNA399803R0600	117
BJMI5-2	1SNA176278R1600	110	CS-R2	1SNK900106R0000	19	FEDAD5	1SNA399804R0700	115
BJMI5-3	1SNA176279R1700	110	CS-R3	1SNK900107R0000	28	FEE10-16	1SNA193449R2400	213
BJMI5-4	1SNA176280R0500	110	CS-RGW-L	1SNA519201R0000	203	FEE6-1	1SNA193080R1200	211
BJMI5-5	1SNA176281R2200	110	CS-RGW-S	1SNA519200R0000	201	FEE8-2	1SNA193085R0300	212
BJMI6-10	1SNA176667R0400	111	D1.5/5.ADO.NF	1SNA400315R0100	110	FEH3	1SNA198352R0700	144
BJMI6-2	1SNA176663R0000	111	D1.5/6.ADO.D2.NF	1SNA399916R2600	118	FEH4	1SNA193878R2200	146
BJMI6-3	1SNA176664R0100	111	D1.5/6.ADO.NF	1SNA399930R1700	111	FEH8	1SNA198729R0100	158
BJMI6-4	1SNA176665R0200	111	D1.5/6.D2.ADO.NF	1SNA399942R1700	117	FEH9	1SNA198549R0500	155
BJMI6-5	1SNA176666R0300	111	D1.5/6.S.ADO.NF	1SNA400083R2500	115	FEHD1	1SNA199400R0600	147
BJMI8-10	1SNA176673R0200	112	D1.5/7.2ADO.CPE.NF	1SNA400154R0000	121	FEHD2	1SNA168949R1700	162
BJMI8-2	1SNA176669R1600	112	D1.5/7.ADO.CPE.NF	1SNA400153R0700	119	FEMAD3	1SNA399802R0500	110
BJMI8-3	1SNA176670R1300	112	D120/42.FF	1SNA190003R2200	198	FEMT1	1SNA193137R0300	214
BJMI8-4	1SNA176671R0000	112	D185/55.FF	1SNA190004R2300	199	FESDH	1SNA400799R0000	159
BJMI8-5	1SNA176672R0100	112	D2.5/7.2ADO.CPE.NF	1SNA400062R0700	123	FIC F.ADO.T1.10PNF	1SSS266210R8800	128
BJS13-10	1SNA167224R2700	190	D2.5/7.2CPE	1SNA400703R1700	126	FIC F.ADO.T1.2PNF	1SSS266202R8800	128
BJS27-2	1SNA205772R1300	196	D2.5/7.ADO.CPE.NF	1SNA400061R0600	122	FIC F.ADO.T1.3PNF	1SSS266203R8800	128
BJS27-3	1SNA205773R1400	196	D2.5/7.ADO.CPE.NF1	1SNA400156R0200	120	FIC F.ADO.T1.4PNF	1SSS266204R8800	128

Type classification

Type	Part Number	Page	Type	Part Number	Page	Type	Part Number	Page
FIC F.ADO.T1.5P.NF	1SSS266205R8800	128	HD35/16.F6.19.1	1SNA295399R0000	183	LH-J	1SNK900606R0000	54
FIC F.ADO.T1.6P.NF	1SSS266206R8800	128	HD4/10.F4.19	1SNA295298R0300	178	LH-R1	1SNK900607R0000	314
FIC F.ADO.T1.7P.NF	1SSS266207R8800	128	HD4/9.F4	1SNA295391R2000	176	M6/8.STP	1SNA195212R1000	214
FIC F.ADO.T1.8P.NF	1SSS266208R8800	128	HD4/9.F4.2	1SNA205392R0700	177	MC512	1SNK140000R0000	19
FIC F.ADO.T1.9P.NF	1SSS266209R8800	128	HD4/9.FF4	1SNA295392R2100	177	MC512PA	1SNK149999R0000	19
FIC F.ADO.T1.B.10P.NF	1SSS266210R9800	129	HD6/13.FF4	1SNA295014R1100	190	MC612	1SNK150000R0000	22
FIC F.ADO.T1.B.2P.NF	1SSS266202R9800	129	HD6/14.DG	1SNA162309R1000	158	MC612PA	1SNK159999R0000	22
FIC F.ADO.T1.B.3P.NF	1SSS266203R9800	129	HD6/14.DH	1SNA162309R1000	158	MC812	1SNK160000R0000	28
FIC F.ADO.T1.B.4P.NF	1SSS266204R9800	129	HD6/14.SDH	1SNA162971R2700	157	MC812PA	1SNK169999R0000	28
FIC F.ADO.T1.B.5P.NF	1SSS266205R9800	129	HD6/14.SDH.1	1SNA162972R2000	161	MCLH	1SNK900630R0000	316
FIC F.ADO.T1.B.6P.NF	1SSS266206R9800	129	HD6/14.SF.2G.2G	1SNA162988R2100	160	MCLH-R1	1SNK900631R0000	316
FIC F.ADO.T1.B.8P.NF	1SSS266208R9800	129	HD6/22.F12G	1SNA162315R2500	155	MCLH-R1-YL	1SNK900634R0000	316
FIC F.ADO.T2.10P.NF	1SSS267210R8800	131	HD6/24.DH	1SNA400782R0000	153	MCLH-YL	1SNK900633R0000	316
FIC F.ADO.T2.2P.NF	1SSS267202R8800	131	HD6/30.F12G	1SNA399963R0500	156	MG-CPM 13 41790	1SNB041790R0512	19
FIC F.ADO.T2.3P.NF	1SSS267203R8800	131	HD6/7.2G.3G	1SNA399964R0600	156	MG-CPM 13 41791	1SNB041791R0612	28
FIC F.ADO.T2.4P.NF	1SSS267204R8800	131	HD6/7.3G.2G	1SNA295015R1200	154	MG-CPM-01 41090	1SNB041090R0510	201
FIC F.ADO.T2.5P.NF	1SSS267205R8800	131	HD6/7.3G.2G.1	1SNA400768R2700	149	MG-CPM-01 41096	1SNB041096R0810	202
FIC F.ADO.T2.6P.NF	1SSS267206R8800	131	HD6/7.5G	1SNA400767R1600	148	MG-CPMFA 43196	1SNB043196R0012	93
FIC F.ADO.T2.7P.NF	1SSS267207R8800	131	HD6/8.2G.2G.1	1SNA400766R1500	147	MG-TAA 49148	1SNB049148R1735	316
FIC F.ADO.T2.8P.NF	1SSS267208R8800	131	HD6/8.2G.2G.2	1SNA160606R1400	145	MG-TAA 49198	1SNB049198R1735	316
FIC F.ADO.T2.B.10P.NF	1SSS267210R9800	132	HD6/9.2G.3G	1SNA160619R1000	146	MG-TAA 49448	1SNB049448R8530	316
FIC F.ADO.T2.B.16P.NF	1SSS267216R9800	132	HD6/9.2G.3G.1	1SNA160564R0100	152	MG-TAA 49498	1SNB049498R8530	316
FIC F.ADO.T2.B.2P.NF	1SSS267202R9800	132	HD6/9.3G.2G	1SNA160563R0000	151	MG-TAR 45194	1SNB045194R1735	316
FIC F.ADO.T2.B.3P.NF	1SSS267203R9800	132	HD6/9.5G	1SNA160621R0200	150	MG-TAR 45490	1SNB045490R8530	316
FIC F.ADO.T2.B.4P.NF	1SSS267204R9800	132	HD6/9.SDH.1	1SNA400800R0000	159	MG-VYT 46415	1SNB046415R0615	332
FIC F.ADO.T2.B.5P.NF	1SSS267205R9800	132	HD70/22.F8.31	1SNA295400R0600	184	MG-VYT 46915	1SNB046915R0615	332
FIC F.ADO.T2.B.6P.NF	1SSS267206R9800	132	HD70/22.F8.31.1	1SNA295401R2300	185	M-W1010PC	1SNA235512R1000	203
FIC F.ADO.T2.B.8P.NF	1SSS267208R9800	132	HD70/22.F8.31.2	1SNA295402R2400	185	M-W610PC	1SNA235511R0600	201
FIC F.ADO.T3-.2P.NF	1SSS277202R8800	130	INH3	1SNA199394R2300	192	M-W810PC	1SNA235510R0800	202
FIC F.ADO.T3-.3P.NF	1SSS277203R8800	130	INH1	1SNA205427R2200	177	OUMAD	1SNA179466R0600	110
FIC F.ADO.T3.4P.NF	1SSS276204R8800	133	JB10-10	1SNA295427R1400	176	OUPAD	1SNA178944R0400	110
FIC F.ADO.T3-.4P.NF	1SSS277204R8800	130	JB10-2	1SNK910310R0000	27	PAM43020	1SNA235106R2600	345
FIC F.ADO.T3.5P.NF	1SSS276205R8800	133	JB10-3	1SNK910302R0000	27	PC	1SNA168497R2300	213
FIC F.ADO.T3-.5P.NF	1SSS277205R8800	130	JB10-3	1SNK910303R0000	27	PC5-10	1SNA113544R1200	253
FIC F.ADO.T3-.6P.NF	1SSS277206R8800	130	JB10-4	1SNK910304R0000	27	PC5-2	1SNA113542R1000	253
FIC M.ADO.T1.FI.10P.NF	1SSS366210R4100	134	JB10-5	1SNK910305R0000	27	PC8-10	1SNA163313R2400	303
FIC M.ADO.T1.FI.2P.NF	1SSS366202R4100	134	JB12-2	1SNK912302R0000	28	PC81-10	1SNA173523R1100	268
FIC M.ADO.T1.FI.3P.NF	1SSS366203R4100	134	JB12-3	1SNK912303R0000	28	PC8-2	1SNA116538R1700	341
FIC M.ADO.T1.FI.4P.NF	1SSS366204R4100	134	JB12-5	1SNK912305R0000	28	PC8-3	1SNA116539R1000	341
FIC M.ADO.T1.FI.5P.NF	1SSS366205R4100	134	JB16-10	1SNK916310R0000	235	PC8-4	1SNA116540R2500	341
FIC M.ADO.T1.FI.6P.NF	1SSS366206R4100	134	JB16-2	1SNK916302R0000	235	PC8-R1	1SNA400711R0600	301
FIC M.ADO.T1.FI.8P.NF	1SSS366208R4100	134	JB16-3	1SNK916303R0000	235	PC8-R2	1SNA400712R0700	303
FIC M.ADO.T2.FI.10P.NF	1SSS367210R4100	135	JB16-4	1SNK916304R0000	235	PC8-R3	1SNA400713R0000	303
FIC M.ADO.T2.FI.2P.NF	1SSS367202R4100	135	JB16-5	1SNK916305R0000	235	PC8-R4	1SNA400724R0300	303
FIC M.ADO.T2.FI.3P.NF	1SSS367203R4100	135	JB22-10	1SNK922310R0000	237	PC8-R5	1SNA400842R0000	303
FIC M.ADO.T2.FI.4P.NF	1SSS367204R4100	135	JB22-2	1SNK922302R0000	237	PC8-R6	1SNA400843R0000	303
FIC M.ADO.T2.FI.5P.NF	1SSS367205R4100	135	JB22-3	1SNK922303R0000	237	PC8-R7	1SNA400849R0000	303
FIC M.ADO.T2.FI.6P.NF	1SSS367206R4100	135	JB22-5	1SNK922305R0000	237	PC8-R8	1SNA400850R0000	303
FIC M.ADO.T2.FI.8P.NF	1SSS367208R4100	135	JB26-10	1SNK926310R0000	238	PC-RG2.5-10	1SNA519103R1000	201
FJDHD	1SNA295426R1300	178	JB26-2	1SNK926302R0000	238	PC-RG2.5-2	1SNA519103R0200	201
FJH501	1SNA199411R1400	153	JB26-3	1SNK926303R0000	238	PC-RG2.5-3	1SNA519103R0300	201
FJHD32	1SNA205431R2600	177	JB26-5	1SNK926305R0000	238	PC-RG2.5-4	1SNA519103R0400	201
FJH50	1SNA295431R1000	176	JB5-10	1SNK905310R0000	19	PC-RG25-2	1SNA519106R0200	203
FJHD40	1SNA205424R2700	181	JB5-2	1SNK905302R0000	19	PC-RG6-10	1SNA519104R1000	202
FJH50	1SNA295424R1100	178	JB5-3	1SNK905303R0000	19	PC-RG6-2	1SNA519104R0200	202
FJH50	1SNA295425R1200	191	JB5-4	1SNK905304R0000	19	PC-RG6-3	1SNA519104R0300	202
HD10/12.F5	1SNA295394R2300	180	JB5-5	1SNK905305R0000	19	PC-RG6-4	1SNA519104R0400	202
HD10/12.F5.1	1SNA295395R2400	181	JB5-50	1SNK905350R0000	19	PC-RG6-7	1SNA519104R0700	202
HD10/12.F5.2	1SNA205396R0300	181	JB6-10	1SNK906310R0000	22	PE	1SNA103007R2300	211
HD10/12.F5.2	1SNA295396R2500	181	JB6-2	1SNK906302R0000	22	PEFH	1SNA163497R1600	153
HD10/12.F5.3	1SNA295011R1600	179	JB6-3	1SNK906303R0000	22	PG5	1SNK900401R0000	50
HD10/12.FF5	1SNA295397R2600	191	JB6-4	1SNK906304R0000	22	PG5-R1	1SNK900402R0000	50
HD120/30.F10.31	1SNA295448R0100	186	JB6-5	1SNK906305R0000	22	PG5-R2	1SNK900403R0000	326
HD120/30.F10.31.1	1SNA295403R2500	187	JB6-50	1SNK906350R0000	22	PIB2-TT	1SNA235155R2600	316
HD16/14.FF5.20	1SNA162979R0700	195	JB8-10	1SNK908310R0000	25	PIB2-TT-YL	1SNA235157R2000	316
HD16/14.FF5.20.3	1SNA295013R1000	193	JB8-10-R1	1SNK908910R0000	302	PL10	1SNK900621R0000	233
HD16/14.FF5.21	1SNA162991R1400	194	JB8-2	1SNK908302R0000	25	PL16	1SNK900622R0000	235
HD16/14.FF5.21.3	1SNA295012R1700	192	JB8-2-R1	1SNK908901R0000	302	PL5	1SNK900618R0000	228
HD185/36.F12.31.1	1SNA295405R2700	188	JB8-3	1SNK908303R0000	25	PL6	1SNK900619R0000	229
HD2.5/6.2G.2G.1	1SNA160487R2500	144	JB8-3-R1	1SNK908903R0000	302	PL8	1SNK900620R0000	232
HD2.5/6.3.2G.2G.1	1SNA190305R0500	166	JB8-4	1SNK908304R0000	25	PR3.G2	1SNA164800R0300	311
HD2.5/6.3.2G.2G.1.GG	1SNA190312R2300	163	JB8-4-R1	1SNK908904R0000	302	PR3.Z2	1SNA174300R1700	310
HD2.5/6.3.3G.3G.1	1SNA190316R2700	162	JB8-5	1SNK908305R0000	25	PR30	1SNA173220R0500	310
HD2.5/6.3.GG.1.2GG	1SNA199025R1400	165	JB85-3	1SNK900603R0000	19	PR4	1SNA168500R1200	312
HD2.5/6.3.GG.1.2G.2G	1SNA190314R2500	164	JB8-5-R1	1SNK908905R0000	302	PR5	1SNA168700R2200	312
HD2.5/6.3.GH.2G.H	1SNA199096R1400	167	KCO	1SNK900624R0000	303	PR50	1SNA178529R0400	311
HD35/16.F6.19	1SNA295398R0700	182	LH	1SNK900605R0000	314	PRH2R	1SNA163350R1500	313



Index

Type classification

Type	Part Number	Page	Type	Part Number	Page	Type	Part Number	Page
PS-3	1SNK900650R0000	328	ZDK2.5-D2-BL	1SNK805223R0000	89	ZK2.5-T3	1SNK705510R0000	58
PT1	1SSS299253R2800	128	ZDK2.5-D2-PE	1SNK805212R0000	91	ZK2.5-WH	1SNK705065R0000	19
PT2	1SSS299254R2800	128	ZDK4-22	1SNK806010R0000	86	ZK2.5-YL	1SNK705060R0000	19
PT-3	1SNK900625R0000	325	ZDS4-22	1SNK805013R0000	98	ZK4	1SNK706010R0000	22
PT-ZD	1SNK900660R0000	93	ZDS4-22-R1	1SNK806013R0000	100	ZK4-3P	1SNK706011R0000	23
RB-12W7	1SNA290455R0700	119	ZK10	1SNK710010R0000	27	ZK4-3P-BL	1SNK706021R0000	23
RC1010	1SNA238000R1600	239	ZK10-3P	1SNK710011R0000	29	ZK4-3P-OR	1SNK706031R0000	23
RC510	1SNA231000R0700	110	ZK10-3P-BL	1SNK710021R0000	29	ZK4-4P	1SNK706012R0000	24
RC55	1SNA235000R1200	110	ZK10-3P-PV	1SNK710064R0000	30	ZK4-4P-BL	1SNK706022R0000	24
RC610	1SNA233000R0100	111	ZK10-3P-PV-BL	1SNK710067R0000	30	ZK4-4P-OR	1SNK706032R0000	24
RC65	1SNA232000R0000	111	ZK10-BL	1SNK710020R0000	27	ZK4-BK	1SNK706066R0000	22
RC810	1SNA234000R0200	112	ZK10-OR	1SNK710030R0000	27	ZK4-BL	1SNK706020R0000	22
RCPEAD-TT	1SNA235158R0100	316	ZK10-PE	1SNK710150R0000	28	ZK4-OR	1SNK706030R0000	22
RCPEAD-TT-YL	1SNA235159R0200	316	ZK10-PE-3P	1SNK710151R0000	30	ZK4-PE	1SNK706150R0000	22
RCPEB	1SNA178430R0500	316	ZK10-PV	1SNK710063R0000	28	ZK4-PE-3P	1SNK706151R0000	23
RDJ6	1SNA173241R0600	144	ZK10-PV-BL	1SNK710065R0000	28	ZK4-PE-4P	1SNK706152R0000	24
REH3	1SNA193155R2600	190	ZK16	1SNK712010R0000	31	ZK4-RD	1SNK706062R0000	22
RGW2.5-PE-V0	1SNA511003R0500	201	ZK16-3P	1SNK712011R0000	33	ZK4-YL	1SNK706060R0000	22
RGW2.5-V0	1SNA510003R0000	201	ZK16-3P-BL	1SNK712021R0000	33	ZK6	1SNK708010R0000	25
RGW25-M5-V0	1SNA510005R0000	203	ZK16-3P-PV	1SNK712064R0000	34	ZK6-3P	1SNK708011R0000	26
RGW25-M6-V0	1SNA510006R0000	204	ZK16-3P-PV-BL	1SNK712067R0000	34	ZK6-3P-BL	1SNK708031R0000	26
RGW6-PE-V0	1SNA511024R0500	202	ZK16-BL	1SNK712020R0000	31	ZK6-3P-OR	1SNK708031R0000	26
RGW6-V0	1SNA510024R0000	202	ZK16-PE	1SNK712150R0000	32	ZK6-BK	1SNK708066R0000	25
RILS	1SNK900627R0000	334	ZK16-PE-3P	1SNK712151R0000	34	ZK6-BL	1SNK708020R0000	25
RPED	1SNA163518R2200	153	ZK16-PV	1SNK712063R0000	32	ZK6-OR	1SNK708030R0000	25
RTC	1SNA163156R2700	153	ZK16-PV-BL	1SNK712065R0000	32	ZK6-PE	1SNK708150R0000	25
SCAD	1SNA196896R0000	111	ZK2.5	1SNK705010R0000	19	ZK6-PE-3P	1SNK708151R0000	26
SCAD5	1SNA199551R2000	110	ZK2.5-3P	1SNK705011R0000	20	ZK6-RD	1SNK708062R0000	25
SCH3	1SNA198692R2500	144	ZK2.5-3P-BK	1SNK705073R0000	20	ZK6-YL	1SNK708060R0000	25
SCH6	1SNA199393R2200	192	ZK2.5-3P-BL	1SNK705021R0000	20	ZS10	1SNK508010R0000	232
SCH8	1SNA199412R1500	153	ZK2.5-3P-GN	1SNK705068R0000	20	ZS10-BK	1SNK508066R0000	232
SCHD1	1SNA205428R0300	177	ZK2.5-3P-OR	1SNK705031R0000	20	ZS10-BL	1SNK508020R0000	232
	1SNA295428R2500	176	ZK2.5-3P-RD	1SNK705069R0000	20	ZS10-BR	1SNK508064R0000	232
SCHD2	1SNA205429R0400	181	ZK2.5-3P-WH	1SNK705072R0000	20	ZS10-GN	1SNK508061R0000	232
	1SNA295429R2600	178	ZK2.5-3P-YL	1SNK705067R0000	20	ZS10-OR	1SNK508030R0000	232
SCHD5	1SNA295430R2300	191	ZK2.5-4P	1SNK705012R0000	21	ZS10-PE	1SNK508150R0000	232
SC-JB8-2	1SNK900652R0000	300	ZK2.5-4P-BK	1SNK705080R0000	21	ZS10-PE-R1	1SNK508151R0000	301
SC-JB8-3	1SNK900653R0000	304	ZK2.5-4P-BL	1SNK705022R0000	21	ZS10-PR	1SNK508063R0000	232
SC-JB8-3-OR	1SNK900657R0000	346	ZK2.5-4P-GN	1SNK705075R0000	21	ZS10-R1	1SNK508011R0000	300
SC-JB8-4	1SNK900654R0000	304	ZK2.5-4P-OR	1SNK705032R0000	21	ZS10-RD	1SNK508062R0000	232
SC-JB8-4-OR	1SNK900658R0000	346	ZK2.5-4P-RD	1SNK705076R0000	21	ZS10-S	1SNK508315R0000	259
SC-JB8-5	1SNK900655R0000	346	ZK2.5-4P-WH	1SNK705079R0000	21	ZS10-S-BL	1SNK508320R0000	259
SHB	1SNK900602R0000	54	ZK2.5-4P-YL	1SNK705074R0000	21	ZS10-SF	1SNK508418R0000	281
SHBP	1SNK900601R0000	19	ZK2.5-BK	1SNK705066R0000	19	ZS10-SF-R1	1SNK508421R0000	282
SHBS	1SNK900600R0000	228	ZK2.5-BL	1SNK705020R0000	19	ZS10-SF-R3	1SNK508422R0000	282
SSB20	1SNA103098R2600	216	ZK2.5-CH-4P-LR	1SNK705710R0000	63	ZS10-SP	1SNK508316R0000	264
SSB20T	1SNA103099R2700	216	ZK2.5-CH-4P-RL	1SNK705711R0000	64	ZS10-S-R2	1SNK508417R0000	283
TC5	1SNK900200R0000	19	ZK2.5-D1	1SNK705211R0000	55	ZS10-ST	1SNK508310R0000	302
TC5-R1	1SNK900201R0000	19	ZK2.5-D1-PE	1SNK705250R0000	54	ZS10-ST-1	1SNK508312R0000	300
TGA8	1SNA168672R1100	268	ZK2.5-D2	1SNK705210R0000	54	ZS10-ST-T4	1SNK508311R0000	300
	1SNA168673R1200	268	ZK2.5-D2-BL	1SNK705220R0000	54	ZS10-WH	1SNK508065R0000	232
	1SNA168674R1300	268	ZK2.5-D2-PE	1SNK705212R0000	56	ZS10-YL	1SNK508060R0000	232
TO3.5-100-INS	1SNK900644R0000	328	ZK2.5-D-CH2-DU-RL	1SNK705219R0000	67	ZS150	1SNK531010R0000	239
TO3.5-50	1SNK900640R0000	328	ZK2.5-D-CH-DU	1SNK705214R0000	66	ZS150-BL	1SNK531020R0000	239
TO3.5-50-A	1SNK900659R0000	328	ZK2.5-D-CH-UD	1SNK705213R0000	65	ZS150-YL	1SNK531060R0000	239
TO4-100	1SNK900641R0000	328	ZK2.5-GN	1SNK705061R0000	19	ZS16	1SNK510010R0000	233
TO5.5-125	1SNK900642R0000	328	ZK2.5-L-L-PE	1SNK705512R0000	60	ZS16-BL	1SNK510020R0000	233
TO6.5-150	1SNK900643R0000	328	ZK2.5-L-N-PE	1SNK705513R0000	61	ZS16-OR	1SNK510030R0000	233
TP2	1SNK900203R0000	28	ZK2.5-OR	1SNK705030R0000	19	ZS16-PE	1SNK510150R0000	233
TP4	1SNK900205R0000	28	ZK2.5-PE	1SNK705150R0000	19	ZS240	1SNK536010R0000	240
UMH	1SNK900611R0000	28	ZK2.5-PE-3P	1SNK705151R0000	20	ZS240-BL	1SNK536020R0000	240
VRADO CPE7	1SNA400063R0000	119	ZK2.5-PE-4P	1SNK705152R0000	21	ZS240-YL	1SNK536060R0000	240
VR-ZD	1SNK900637R0000	93	ZK2.5-RD	1SNK705062R0000	19	ZS25	1SNK512010R0000	234
VSJ6	1SNA167735R2700	144	ZK2.5-S	1SNK705310R0000	47	ZS25-BL	1SNK512020R0000	234
ZD2.5-11	1SNK805016R0000	80	ZK2.5-S-4P	1SNK705312R0000	48	ZS25-PE	1SNK512150R0000	234
ZD2.5-22	1SNK805017R0000	81	ZK2.5-S-4P-BL	1SNK705321R0000	48	ZS25-YL	1SNK512060R0000	234
ZD2.5-22-PE	1SNK805156R0000	82	ZK2.5-S-4P-OR	1SNK705331R0000	48	ZS35	1SNK512010R0000	235
ZDK2.5-11	1SNK805015R0000	83	ZK2.5-S-BL	1SNK705320R0000	47	ZS35-BL	1SNK516020R0000	235
ZDK2.5-11-BL	1SNK805025R0000	83	ZK2.5-SF	1SNK706410R0000	49	ZS35-OR	1SNK516030R0000	235
ZDK2.5-11-PE	1SNK805150R0000	87	ZK2.5-SF-R1	1SNK706411R0000	53	ZS35-PE	1SNK516150R0000	235
ZDK2.5-21	1SNK805014R0000	84	ZK2.5-SF-R3	1SNK706412R0000	53	ZS35-PEN	1SNK516170R0000	249
ZDK2.5-22	1SNK805010R0000	85	ZK2.5-S-OR	1SNK705330R0000	47	ZS4	1SNK505010R0000	228
ZDK2.5-22-BL	1SNK805020R0000	85	ZK2.5-SP	1SNK705311R0000	50	ZS4-BK	1SNK505066R0000	228
ZDK2.5-22-PE	1SNK805152R0000	88	ZK2.5-SP-4P	1SNK705313R0000	51	ZS4-BL	1SNK505020R0000	228
ZDK2.5-D1	1SNK805214R0000	90	ZK2.5-S-R1	1SNK706310R0000	49	ZS4-BR	1SNK505064R0000	228
ZDK2.5-D1-PE	1SNK805250R0000	92	ZK2.5-T1	1SNK705511R0000	59	ZS4-D1	1SNK505211R0000	285
ZDK2.5-D2	1SNK805213R0000	89	ZK2.5-T1-PE	1SNK705550R0000	58	ZS4-D2	1SNK505210R0000	284

Index_1SNK160034C0201

Index

Type classification

Type	Part Number	Page	Type	Part Number	Page	Type	Part Number	Page
ZS4-D2-BL	1SNK505220R0000	284	ZS6-D2-BK	1SNK506266R0000	286			
ZS4-D2-OR	1SNK505230R0000	284	ZS6-D2-BL	1SNK506220R0000	286			
ZS4-D2-S	1SNK505315R0000	290	ZS6-D2-OR	1SNK506230R0000	286			
ZS4-D2-SF1	1SNK508425R0000	292	ZS6-D2-PE	1SNK506212R0000	288			
ZS4-D2-SF1-R1	1SNK508423R0000	293	ZS6-D2-RD	1SNK506262R0000	286			
ZS4-D2-SF1-R3	1SNK508424R0000	293	ZS6-D2-WH	1SNK506265R0000	286			
ZS4-D2-S-T2	1SNK505316R0000	291	ZS6-D2-YL	1SNK506260R0000	286			
ZS4-D-CH-DU	1SNK505215R0000	297	ZS6-GN	1SNK506061R0000	229			
ZS4-D-CH-UD	1SNK505214R0000	296	ZS6-OR	1SNK506030R0000	229			
ZS4-GN	1SNK505061R0000	228	ZS6-PE	1SNK506150R0000	229			
ZS4-OR	1SNK505030R0000	228	ZS6-PR	1SNK506063R0000	229			
ZS4-PE	1SNK505150R0000	228	ZS6-RD	1SNK506062R0000	229			
ZS4-PE-R2	1SNK506153R0000	279	ZS6-S	1SNK506315R0000	257			
ZS4-PR	1SNK505063R0000	228	ZS6-S-4S-T2	1SNK506316R0000	258			
ZS4-R1	1SNK508013R0000	272	ZS6-S-BL	1SNK506322R0000	257			
ZS4-R2	1SNK506013R0000	278	ZS6-WH	1SNK506065R0000	229			
ZS4-RD	1SNK505062R0000	228	ZS6-YL	1SNK506060R0000	229			
ZS4-S	1SNK505310R0000	253	ZS70	1SNK522010R0000	237			
ZS4-S-BL	1SNK505320R0000	253	ZS70-BL	1SNK522020R0000	237			
ZS4-SF	1SNK506410R0000	274	ZS70-PE	1SNK522150R0000	237			
ZS4-SF1	1SNK508410R0000	268	ZS70-YL	1SNK522060R0000	237			
ZS4-SF1-OR	1SNK508430R0000	268	ZS95	1SNK526010R0000	238			
ZS4-SF1-R1	1SNK508412R0000	270	ZS95-BL	1SNK526020R0000	238			
ZS4-SF1-R2	1SNK508413R0000	271	ZS95-PE	1SNK526150R0000	238			
ZS4-SF1-R3	1SNK508414R0000	270	ZS95-YL	1SNK526060R0000	238			
ZS4-SF1-R4	1SNK508415R0000	271						
ZS4-SF1-T2	1SNK508411R0000	269						
ZS4-SF-R1	1SNK506412R0000	276						
ZS4-SF-R2	1SNK506413R0000	277						
ZS4-SF-R3	1SNK506415R0000	276						
ZS4-SF-R4	1SNK506416R0000	277						
ZS4-SF-T2	1SNK506411R0000	275						
ZS4-S-OR	1SNK505330R0000	253						
ZS4-SP	1SNK505313R0000	260						
ZS4-SP-R1	1SNK506313R0000	262						
ZS4-SP-T2	1SNK505314R0000	261						
ZS4-SP-T2-R1	1SNK506314R0000	263						
ZS4-S-R1	1SNK506310R0000	255						
ZS4-S-R1-BL	1SNK506320R0000	255						
ZS4-S-R1-OR	1SNK506330R0000	255						
ZS4-S-R2	1SNK506414R0000	280						
ZS4-S-R3	1SNK508416R0000	273						
ZS4-S-R3-T2	1SNK508419R0000	273						
ZS4-S-T2	1SNK505311R0000	254						
ZS4-S-T2.3	1SNK505312R0000	254						
ZS4-S-T2.3-R1	1SNK506312R0000	256						
ZS4-S-T2-BL	1SNK505321R0000	254						
ZS4-S-T2-OR	1SNK505331R0000	254						
ZS4-S-T2-R1	1SNK506311R0000	256						
ZS4-S-T2-R1-BL	1SNK506321R0000	256						
ZS4-S-T2-R1-OR	1SNK506331R0000	256						
ZS4-T3	1SNK505212R0000	294						
ZS4-T3-R1	1SNK506213R0000	295						
ZS4-WH	1SNK505065R0000	228						
ZS4-YL	1SNK505060R0000	228						
ZS50	1SNK516011R0000	236						
ZS50-BK	1SNK516064R0000	236						
ZS50-BL	1SNK516021R0000	236						
ZS50-PE	1SNK516151R0000	236						
ZS50-RD	1SNK516063R0000	236						
ZS50-YL	1SNK516060R0000	236						
ZS6	1SNK506010R0000	229						
ZS6-3S	1SNK506011R0000	230						
ZS6-3S-BL	1SNK506021R0000	230						
ZS6-3S-PE	1SNK506151R0000	230						
ZS6-3S-YL	1SNK506067R0000	230						
ZS6-4S	1SNK506012R0000	231						
ZS6-4S-BL	1SNK506022R0000	231						
ZS6-4S-PE	1SNK506152R0000	231						
ZS6-4S-YL	1SNK506068R0000	231						
ZS6-BK	1SNK506066R0000	229						
ZS6-BL	1SNK506020R0000	229						
ZS6-BR	1SNK506064R0000	229						
ZS6-D1	1SNK506211R0000	287						
ZS6-D1-PE	1SNK506250R0000	286						
ZS6-D1-RD	1SNK506214R0000	287						
ZS6-D2	1SNK506210R0000	286						

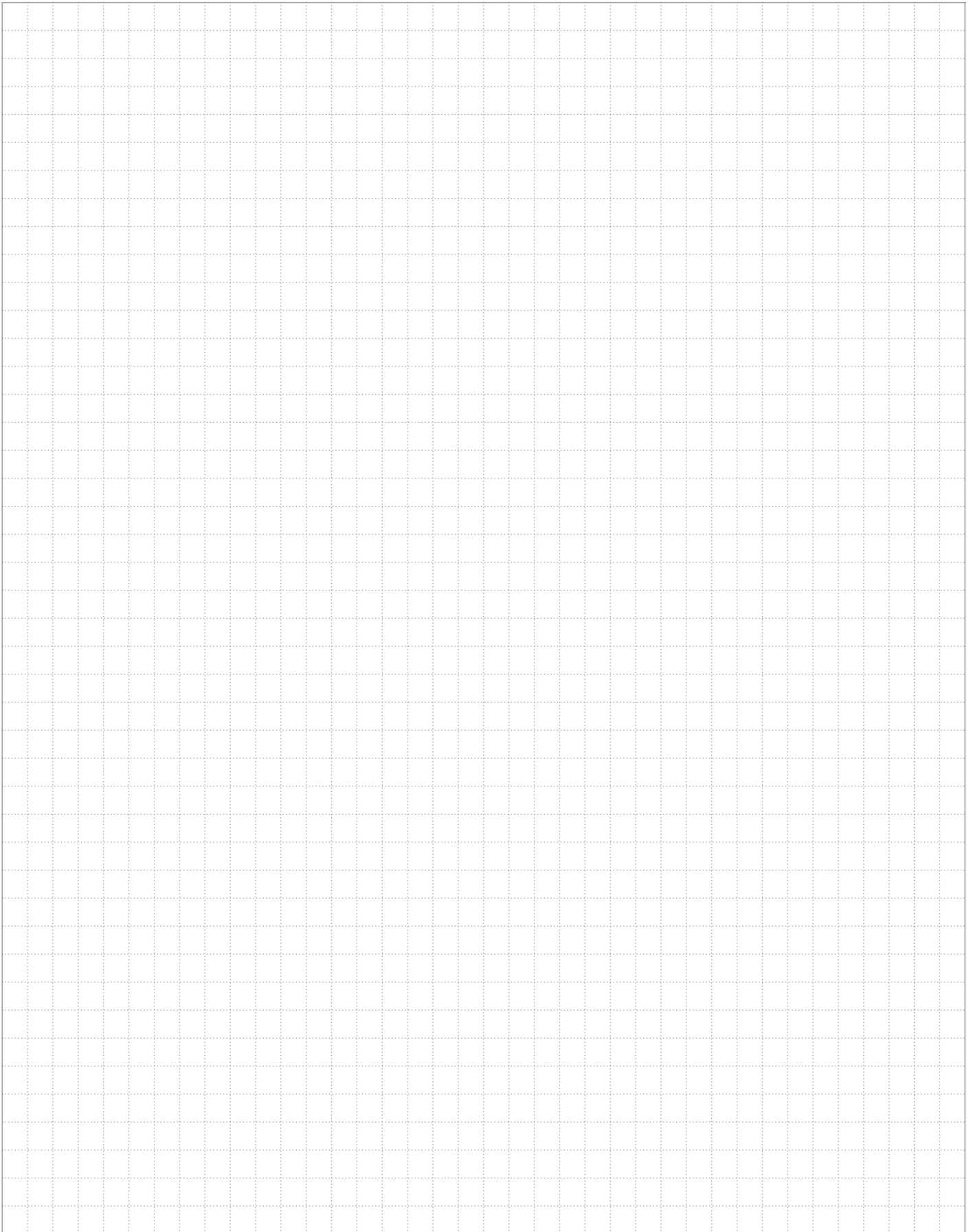

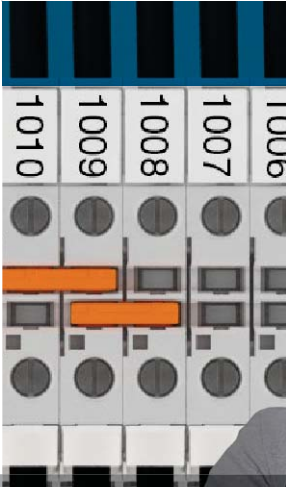

MARKING SOLUTIONS

Markers & marking systems

ENTRELEC Terminal Blocks

TE Connectivity proposes a large scope of solutions for all identification requirements within the electrical panel.

Identify all your equipment through our comprehensive range of markers, labels for terminal block, wire & cable, component & equipment...

Find your favorite marking solution from budget sensitive printing jobs to high quality & volume projects.

Marking solutions

Markers and marking systems



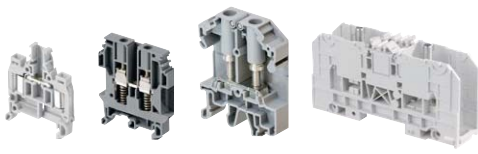
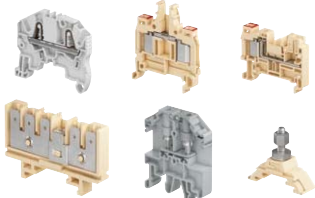

Overview	2	1
HTP500 thermal transfer printer and compatible markers	9	2
MG3 thermal transfer printer and compatible markers	37	3
AMS 600 and AMS 250 plotter and compatible markers	75	4
Pre-printed and customized markers	111	5
Other manufacturers' terminal block markers selection guides	158	6
Index	170	7

TE Connectivity proposes one of the largest Din Rail Terminal block offering on the market with various technologies: screw, PI-Spring, spring, IDC, pluggable, stud, etc. found in over 8000 products & solutions.

	SNK terminal blocks		Dedicated applications terminal blocks		Terminal blocks for railway applications
					
Scope	Qualified for worldwide applications and severe environments (such as hazardous locations, railways, marine and solar applications..). From 0.2 to 300 mm ² .		Specific terminal blocks and technologies for dedicated applications and markets.		The largest offering on the market for rolling stock and infrastructures.
Product families & functions	SNK PI-Spring technology 2.5 to 16 mm ² 12 to 4 AWG	Feed-through Multi-deck Ground Disconnect for fuses Component holder	ADO System® (IDC) 0.22 to 4 mm ² 24 to 12 AWG	ADO-ADO or ADO-screw clamp Feed-through / Multi-deck / Ground / Disconnect / for fuses / Component holder	SNK PI-Spring technology 2.5 to 16 mm ² 12 to 4 AWG
			Safety (spring loaded) 0.22 to 10 mm ² 24 to 6 AWG	Feed-through Disconnect Test & measurement	SNK pluggable screw & PI-Spring technologies 2.5 to 4 mm ² 12 to 10 AWG
	SNK screw clamp technology 4 to 240 mm ² 12 to 500 Kcmil	Feed-through Multi-deck Ground Disconnect for fuses Test & measurement Marshalling Component holder	Stud 25 to 300 mm ² 4 AWG to 1000 Kcmil	One stud 2 studs One stud - One screw clamp	ADO System® (IDC) 1.5 to 4 mm ² 16 to 12 AWG
			Ring lug 6 to 16 mm ² 8 to 6 AWG	Feed-through Test & measurement	Stud 4 to 185 mm ²
	SNK pluggable screw & PI-Spring technologies 2.5 to 4 mm ² 12 to 10 AWG	Feed-through Multi-deck Ground	Miniblocks 1.5 to 6 mm ² 18 to 8 AWG	Screw clamp Spring ADO System® (IDC)	Quick-connect 2.5 to 6 mm ²
			Other types Test & measurement: with sliding link, blade, plug Pluggable: feed-through, double deck, disconnect Sensors/actuators: screw, spring, ADO system (IDC) Installation: screw, spring Protection: ground + neutral Component holders: screw, spring, ADO system (IDC)		



www.te.com

DBL power distribution blocks	ESSAILEC® test blocks	Interfast PLC pre-wiring system	Marking solutions
			
<p>The preferred choice for primary power distribution and solar applications.</p>	<p>Test blocks for safe and easy testing on secondary circuits of current and voltage transformers and sensors.</p>	<p>PLC pre-wiring system for fast, flexible, reliable connection of PLC's in process automation applications.</p>	<p>Markers & marking systems for all identification requirements in electrical panels.</p>
<p>From 80 A up to 550 A (IEC)</p> <p>Modular blocks: single pole, three & four poles, up to 12 outputs</p> <p>Terminal blocks types: 2 to 10 poles, up to 20 outputs</p>	<p>Current and voltage sockets & plugs</p> <p>Simultaneous testing of 1 to 4 independent circuits on the same socket</p> <p>Several testing principle such as "make before break" for safe current transformer testing</p> <p>Panel and switchboard mounting : base, flush, rack, TH35 rail</p> <p>Multicircuits sockets & plugs</p>	<p>Interfast PCB: Compact & standard modules</p> <p>Interfast MS: Modular system based on terminal block technology</p> <p>Functions:</p> <ul style="list-style-type: none"> - 1 to 4 wire connections (sensors) - Disconnect - Fuse - Signal indication - Relays - Optocouplers - Solenoid valve control - Galvanic isolation (2.5 kV). 	<p>Terminal block identification and group markers</p> <p>Wire and cable identification</p> <p>Component and equipment identification</p> <p>Panel identification</p> <p>Pre-printed markers for terminal blocks</p>

Marking solutions

Comprehensive range for all identification requirements

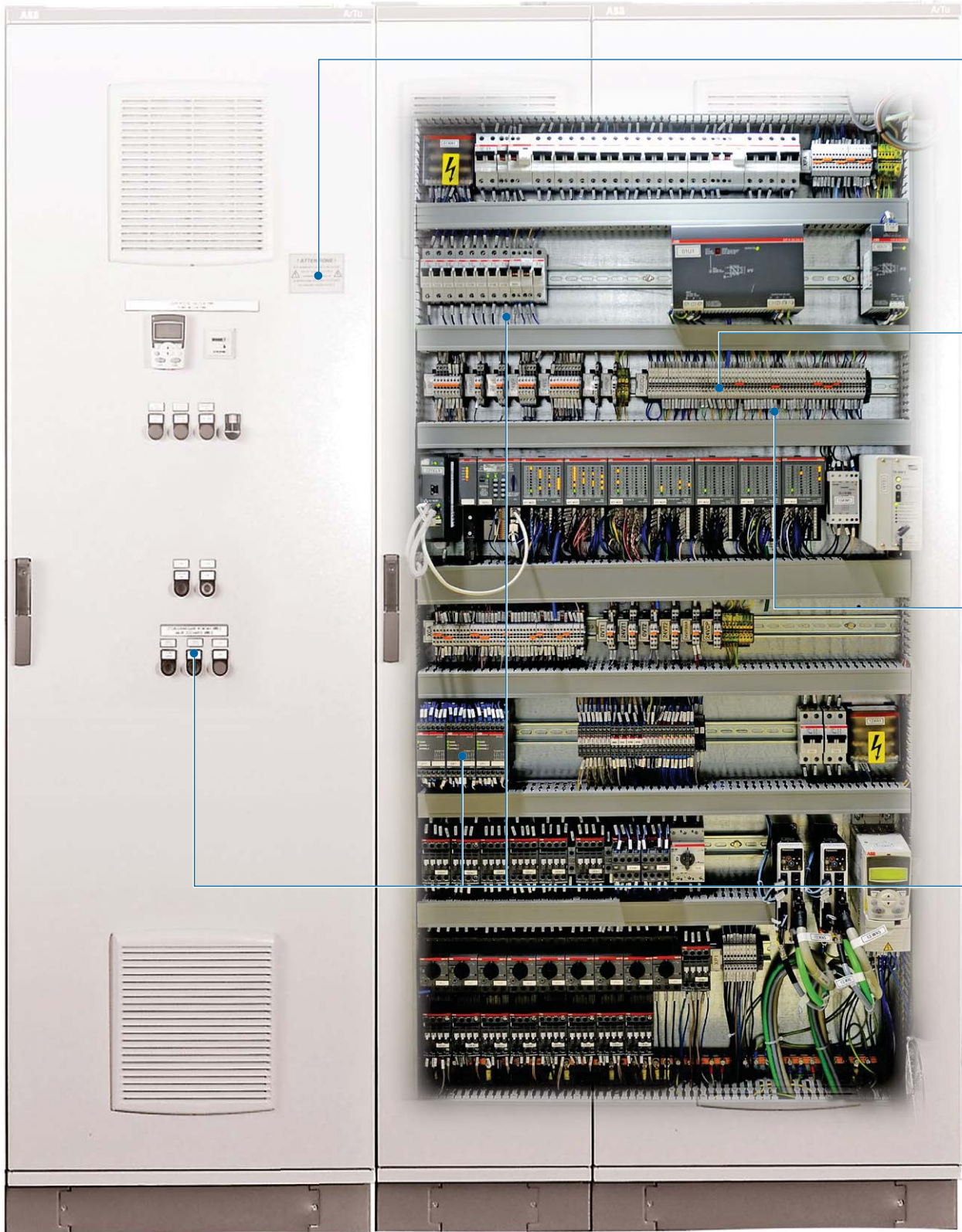

Panel identification



Terminal block identification and group markers

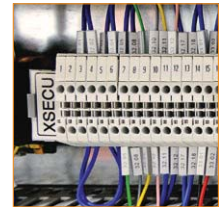

Wire and cable identification



Component and equipment identification

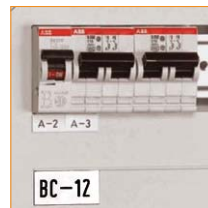

For versatile applications



Marking systems	MG3
Technology	Thermal transfer
Printing mode	Manual
Printing speed	Medium
Printing quality	300 x 600 dpi
1 ribbon or ink cartridge printing capacity	~ 160 000, MG-CPM (5 x 10 mm markers)
Printing color available (monochrome)	Black / Red / Blue / Green / White
Terminal block markers material	Polycarbonate
Terminal block markers	
SNK series terminal blocks blank markers polyamide	–
SNK series terminal blocks blank markers polycarbonate	MG-CPM
SNK series terminal blocks blank markers PVC	MG-CPMF
SNA and solution series terminal blocks blank markers polyamide	–
SNA and solution series terminal blocks blank markers polycarbonate	MG-CPM
SNA and solution series terminal blocks blank markers PVC	MG-CPMF
SNA and solution series terminal blocks blank side markers (5 mm height) polyamide	–
End stop markers	2 marker types
Other terminal blocks manufacturers blank markers	15 manufacturers
Wires and cables markers	4 marker types
Components and equipment markers	9 marker types

For basic marking applications



AMS 600 - AMS 250

Plotter

Manual

Low

300 x 300 dpi

~ 230 000 markers (with 3 characters per markers)

Black

Polyamide

MC...PA

-

-

RC / RCAL / RB / RCT / RCP5 / RPEV

-

REH / RTM

RC55 / RC65

4 marker types

5 manufacturers

1 marker type

9 marker types

Marking solutions

Blank markers and labels for HTP500 thermal transfer printer

HTP500 kit and accessories

10



Terminal block identification

Selection guide for terminal block markers			12
Terminal block markers	MC...	for SNK series	14
	RC...TT	for SNA and Solution series	15
Other manufacturers' terminal block markers	RCP, RCW, RCL		16
End stop markers	MCLH, MCLH-R1	for SNK series	18
	RCPEAD-TT	for SNA and Solution series	20
End stop label holders and covers	LH, LH-R1	for SNK series	19
	PEAD, EPR2	for SNA and Solution series	20
	PEB, PEBM, EPR1	for SNA and Solution series	29



Wire and cable identification

Selection guide for wire and cable markers			22
Wire and cable markers	WMTT	PVC label (need label holder)	24
	PCGS	large label (need label holder)	26
Wire and cables label holders	RING, SNAP, RINGT23	transparent label holder	25
	RINGT209	for large label tied-on thick cables	26

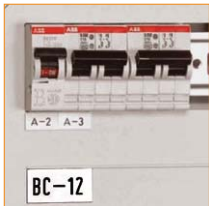

Component and equipment identification

Self-adhesive labels	RPA-TT, PIB2-TT		28
	PAM	for strip identification	30
Pre-cut labels	BA4	for contactors, relays...	31
	PPB	two-colored label	32
Label holders and covers	PAM100015, PCT	15 mm rail and protective cover	33
	KA1-8120	push-button marker holder	33



Panel identification

Self-adhesive panel plates	PAT		34
Rivet fixing panel plates	PPT		34

Other manufacturers markers selection guide

158

HTP500 thermal transfer printer

Kit and accessories



HTP500-V2 KIT



HTP500-CLEAN



HTP500-FEED



HTP500-PL



HTP500-PL2



HTP500-PL3



RIB-B

Description

- Performance,
- High volume and serial production,
- Dedicated to terminal blocks.

Ordering details

Description	Type	Part Number	Pkg pce	Weight (1 pce) g
Thermal transfer printer KIT	HTP500-V2 KIT	1SNA235700R1500	1	16000.00
List of items included in the KIT :				
1 HTP500-V2 Thermal transfer printer	HTP500-V2			
1 software CD	HTS500			
1 power supply cable	HTP500-PW			
1 USB cable	HTP500-USB			
1 support table	HTP500-BAS			
1 universal feeder for marker cards	HTP500-FEED			
1 cleaning cassette	HTP500-CLEAN			
1 black ribbon cassette	RIB-B			
1 support plate for terminal block markers	HTP500-PL2			
1 universal support plate for wire markers	HTP500-PL			

Feeders and support plates

Description	Type	Part Number	Pkg pce	Weight (1 pce) g
Universal feeder for marker cards	HTP500-FEED	1SNA235703R0400	1	515.00
Support plate for terminal block markers	HTP500-PL2	1SNA235705R0600	1	130.00
Universal support plate for wire markers	HTP500-PL	1SNA235704R0500	1	294.00
Support plate for other manufacturers terminal block markers	HTP500-PL3	1SNA235707R0000	1	130.00
Support plate for BA4 markers	HTP500-BA4	1SNA235712R2400	1	291.00























Accessories

Description	Type	Part Number	Pkg pce	Weight (1 pce) g
Black ribbon cassette	RIB-B	1SNA235710R0600	3	69.03
Red ribbon cassette for identification plates and adhesive labels	RIB-R	1SNA235711R2300	3	69.03
Red ribbon cassette for terminal blocks and wire markers	RIB-RS	1SNA235718R0200	3	69.03
Cleaning cassette	HTP500-CLEAN	1SNA235714R2600	1	83.50
Standard cleaning roll ø18	HTP500-ROLL	1SNA235715R2700	1	40.50
Printing head	HTP500-PRINT	1SNA235716R2000	1	20.00
Power supply cable	HTP500-PW	1SNA235709R1200	1	120.00
Dust cover for HTP500 and AMS 500 systems	DUST COVER	1SNA360161R1500	1	200.00
Wooden box for HTP500-V2 KIT	HTP500-WB	1SNA235717R2100	1	9980.00
Software CD	HTS500	1SNA235702R0300	1	17.00
Support table	HTP500-BAS	1SNA235706R0700	1	4060.00
Power supply cable	HTP500-PW	1SNA235709R1200	1	120.00

HTP500 markers selection guide







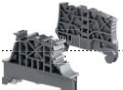

Terminal block blank markers selection guide

Terminal blocks (Terminal blocks styles not listed on the chart do not have a marker compatible with this printer)

Connection technology	Terminal block part number	Marker type	Marker mounting
Screw clamp 	1SNK... 	Strip marker 	Top and side marking 
	1SNA... (1) 	Strip marker 	Side marking 
PI-Spring and pluggable PI-Spring 	1SNK... 	Strip marker 	Top and side marking 
Spring clamp 	1SNA... (1) 	Strip marker 	Top marking 
Spring loaded screw clamp 	1SNA... 	Strip marker 	Side marking 
Pluggable screw clamp 	1SNA... 	Strip marker 	Side marking 

(1) Except mini-blocks.

SNK series end stop and label holders











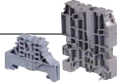



BAZ1 	Individual marker 	Top marking 	MC512
BAM4 		Top and side marking 	MC812
LH (label holder for BAM4, BAZH1, BAZ1) 	Label 	Top marking 	MC-LH
LH-R1 (label holder for BAM4, BAZH1, BAZ1) 			MC-LHR1



Terminal blocks spacing											
5 mm 0.197 in	5.08 mm 0.200 in	5.2 mm 0.205 in	6 mm 0.236 in	8 mm 0.315 in	10 mm 0.394 in	12 mm 0.472 in	16 mm 0.630 in	22 mm 0.866 in	26 mm 1.024 in	31 mm 1.220 in	36 mm 1.417 in
		MC512	MC612	MC812	MC812 (2)						
RC510TT			RC610TT	RC810TT	RC810TT (2)						
		MC512	MC612	MC812	MC812 (2)						
RC510TT			RC610TT	RC810TT	RC810TT (2)						
			RC610TT	RC810TT	RC810TT (2)						
	RC510TT										

(2) Marker width < marking's area size - markers must be mounted individually.

SNA series end stop and label holders

BAM2, BADH		Individual marker		Top and side marking		RC810TT (2)
BADL						RC810TT
BADRL, BAR		Individual marker		Top marking		RC610TT
BAMH						RC810TT
PEAD (Label holder for BAM2 and BADL)		Label		Top marking		RCPEAD-TT
PEB		Label		Top marking		PIB2-TT

(2) Marker width < marking's area size - markers must be mounted individually.

MC terminal block markers

Blank markers for SNK series



1SNK160190R0014

MC512

Description

- Blank marker card designed for high marking quality,
- Dedicated to SNK series terminal block marking,
- Excellent marking durability in the most severe environments,
- Made of rigid polycarbonate.

Main technical data

Material	Flammability	Temperature range
Polycarbonate	V0	-55°C to +110°C -67°F to +230°F

Ordering details

Dimensions	Maximum printed digits	Nb. of markers per card	Color	Type	Part Number	Pkg	Weight

SNK series terminal block markers

MC512



For 5.2 mm 0.205 in spacing terminal blocks and BAZ1 end stop

12 x 5	0.472 x 0.197	3	8	45	White <input type="checkbox"/>	MC512	1SNK140000R0000	22	9.00
					Yellow <input checked="" type="checkbox"/>	MC512-YL	1SNK140004R0000	22	9.00

MC612



For 6 mm 0.236 in spacing terminal blocks

12 x 5.6	0.472 x 0.220	3	8	39	White <input type="checkbox"/>	MC612	1SNK150000R0000	22	10.00
					Yellow <input checked="" type="checkbox"/>	MC612-YL	1SNK150004R0000	22	10.00

MC812



For 8 mm 0.315 in and larger spacing terminal blocks and BAM4 end stop

12 x 7.6	0.472 x 0.299	4	8	30	White <input type="checkbox"/>	MC812	1SNK160000R0000	22	10.00
					Yellow <input checked="" type="checkbox"/>	MC812-YL	1SNK160004R0000	22	10.00

Marking System Accessories

HTP500-PL2



Support plate

Included in the HTP500-V2 kit						HTP500-PL2	1SNA235705R0600	1	291.00
-------------------------------	--	--	--	--	--	------------	-----------------	---	--------

Mounting instruction



1SNK160190S0201



RC..TT terminal block markers

Blank markers for SNA and Solution series



RC510TT

1SNC16C246F0014

Description

- Blank marker card designed for high marking quality,
- Excellent marking durability in the most severe environments,
- Made of rigid polycarbonate.

Main technical data

Material	Flammability	Temperature range
Polycarbonate	V0	-50°C to +120°C -58°F to +248°F

Ordering details

Dimensions		Maximum printed digits		Nb. of markers per card	Color	Type	Part Number	Pkg card	Weight (1 card) g
mm	in	Hor.	Vert.						

For 5 mm 0.197 in terminal block spacing

RC510TT

For 5 mm 0.197 in spacing terminal blocks



10 x 5	0.394 x 0.197	3	7	48	White <input type="checkbox"/>	RC510TT	1SNA231600R1500	22	12.00
					Yellow <input checked="" type="checkbox"/>	RC510TT-YL	1SNA231700R1100	22	12.00

For 6 mm 0.236 in terminal block spacing

RC610TT

For 6 mm 0.236 in spacing terminal blocks



10 x 6	0.394 x 0.236	3	7	39	White <input type="checkbox"/>	RC610TT	1SNA233600R1700	22	12.00
					Yellow <input checked="" type="checkbox"/>	RC610TT-YL	1SNA233700R1300	22	12.00

For 8 mm 0.315 in terminal block spacing

RC810TT

For 8 mm 0.315 in and larger spacing terminal blocks and end stops from SNA series



10 x 8	0.394 x 0.315	4	7	30	White <input type="checkbox"/>	RC810TT	1SNA234600R1000	22	12.00
					Yellow <input checked="" type="checkbox"/>	RC810TT-YL	1SNA234700R1400	22	12.00

Marking System Accessories

HTP500-PL2

Support plate



Included in the HTP500-V2 kit		HTP500-PL2	1SNA235705R0600	1	291.00
-------------------------------	--	------------	-----------------	---	--------

Mounting instruction



1SNC160191S0201

RCP, RCW, RCL terminal block markers

Blank markers for other manufacturers

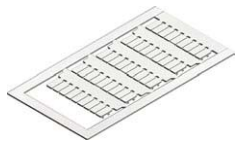

1SNC160249FC014

RCP510

Description

- Blank marker card designed for high marking quality,
- To be used to mark terminal blocks from other manufacturers,
- Excellent marking durability in the most severe environments,
- Made of rigid polycarbonate.

Main technical data

Material	Flammability	Temperature range
Polycarbonate	V0	-50°C to +120°C -58°F to +248°F

Ordering details

Dimensions		Maximum printed digits		Nb. of markers per card	Color	Type	Part Number	Pkg card	Weight (1 card) g
mm	in	Hor.	Vert.						

RCP510

For Wago and Phoenix screw clamp terminal blocks

10 x 5	0.394 x 0.197	3	7	45	White <input type="checkbox"/>	RCP510	1SNA235095R1600	12	11.25
--------	---------------	---	---	----	--------------------------------	--------	-----------------	----	-------



RCW510

For Weidmüller terminal blocks

10 x 5	0.394 x 0.197	3	7	45	White <input type="checkbox"/>	RCW510	1SNA235096R1700	12	10.83
--------	---------------	---	---	----	--------------------------------	--------	-----------------	----	-------



RCL510

For Legrand, Wieland and Télémécanique terminal blocks

10 x 5	0.394 x 0.197	3	7	45	White <input type="checkbox"/>	RCL510	1SNA235097R1000	12	10.42
--------	---------------	---	---	----	--------------------------------	--------	-----------------	----	-------



Marking System Accessories

HTP500-PL3

Support plate

Purchased separately						HTP500-PL3	1SNA235707R0000	1	130.00
----------------------	--	--	--	--	--	------------	-----------------	---	--------

See other manufacturer selection guide at the end of this catalogue.



1SNC160192S0201



MCLH end stop markers

Self-adhesive precut blank labels for SNK series

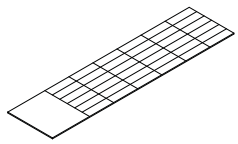

1SNK900630R0000

MCLH, MCLH-R1

Description

– Identify your terminal block assemblies with the self-adhesive label adapted to the LH label holders.

Main technical data

Material	Flammability	Temperature range
PVC + Adhesive acrylic	V0	-55°C to +110°C -67°F to +230°F

Ordering details

Dimensions		Nb. of markers per card	Color	Type	Part Number	Pkg card	Weight (1 card) g
mm	in						

For LH label holder

MCLH

30 x 8.8	1.181 x 0.346	36	White <input type="checkbox"/>	MCLH	1SNK900630R0000	25	10.00
			Yellow <input type="checkbox"/>	MCLH-YL	1SNK900633R0000	25	10.00

For LH-R1 label holder

MCLH-R1

35.35 x 17.65	1.392 x 0.695	15	White <input type="checkbox"/>	MCLH-R1	1SNK900631R0000	25	10.00
			Yellow <input type="checkbox"/>	MCLH-R1-YL	1SNK900634R0000	25	10.00

Marking system accessories

No support plate needed.
Direct insertion into HTP500 marking system for printing.

Mounting instruction

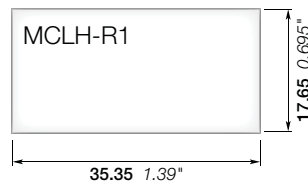
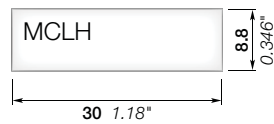

Compatible holders



LH



LH-R1

1SNK160200S0201



LH, LH-R1 end stop label holders

For MCLH labels



1SNK160210F0014

Description

- Easily identify your terminal blocks assembly with white or yellow labels,
- Adjustable in height for best visibility,
- Compatible with all SNK end stops.

Main technical data

Material	Flammability	Temperature range
Polyamide	V0	-55°C to +110°C -67°F to +230°F

Ordering details

Spacing		Dimensions		Color	Type	Part Number	Pkg	Weight
mm	in	mm	in					

For MCLH

LH								
10	0.394	8.8 x 30	0.35 x 1.18	Dark Grey	LH	1SNK900605R0000	50	0.60

For MCLH-R1

LH-R1								
19.5	0.768	17.9 x 35.65	0.70 x 1.40	Dark Grey	LH-R1	1SNK900607R0000	50	1.10

Dimensions given apply to the labelling area.



LH



LH-R1

Compatible end stops



BAM4
1SNK900001R0000



BAZ1
1SNK900002R0000



BAZH1
1SNK900102R0000

1SNK160201S0201



RCPEAD-TT end stop labels

Self-adhesive precut blank labels

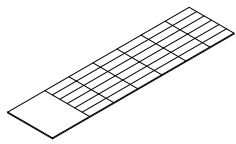

RCPEAD-TT

1SNC700302E0000

Description

- Identify your terminal block assemblies with the self-adhesive label adapted to the PEAD label holders.

Main technical data

Material	Flammability
PVC + Adhesive acrylic	V0

Ordering details

Dimensions	Nb. of markers per card	Color	Type	Part Number	Pkg card	Weight (1 card) g
mm	in					
RCPEAD-TT						
9 x 29	0.354 x 1.142	36	White <input type="checkbox"/>	RCPEAD-TT	1SNA235158R0100	25 9.80
			Yellow <input type="checkbox"/>	RCPEAD-TT-YL	1SNA235159R0200	25 9.60

Marking system accessories

No support plate needed.
Direct insertion into HTP500 marking system for printing.

Mounting instruction

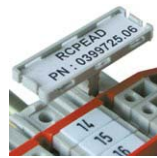

PEAD + RCPEAD-TT

PEAD end stop label holders

For RCPEAD label



PEAD

1SNC16005E0014

Description

- Easily identify your terminal block assemblies with white or yellow labels,
- Adjustable in height for best visibility,
- Compatible with BAM2 and BADL SNA series end stops.

Main technical data

Material	Flammability
Polyamide	V0

Ordering details

Dimensions	Color	Type	Part Number	Pkg pce	Weight (1 pce) g
mm	in				
PEAD					
Label holder for end stop, compatible with RCPEAD and RCEPAD-TT markers and EPR2 cover.					
9 x 29	0.354 x 1.142	Grey <input type="checkbox"/>	PEAD	1SNA399719R1000	20 0.78
Dimensions given apply to the labelling area.					

EPR2

Card of 20 covers for RCPEAD and RCPEAD-TT markers

9 x 29	0.354 x 1.142	Transparent <input checked="" type="checkbox"/>	EPR2	1SNA399726R0700	1 4.00
--------	---------------	---	------	-----------------	--------

Compatible end stops



BAM2
1SNA206351R1600



BADL
1SNA399903R0200

HTP500 wire and cable markers

Selection guide

Evolute and protected wire and cable identification

Each individual label and label holder is easily detached from the stem for installation onto cable. The printed label in its holder is perfectly protected over time.

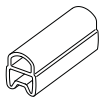

RING

Slide-on cable label holders to be used before connecting the wires.

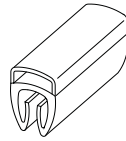

SNAP

Clip-on cable label holders to be snap-on the wire already connected or not.

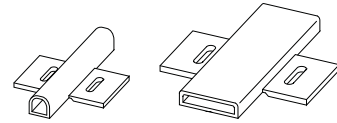

RINGT

Tie-on cable label holders recommended for thick tube, hose and conduit.

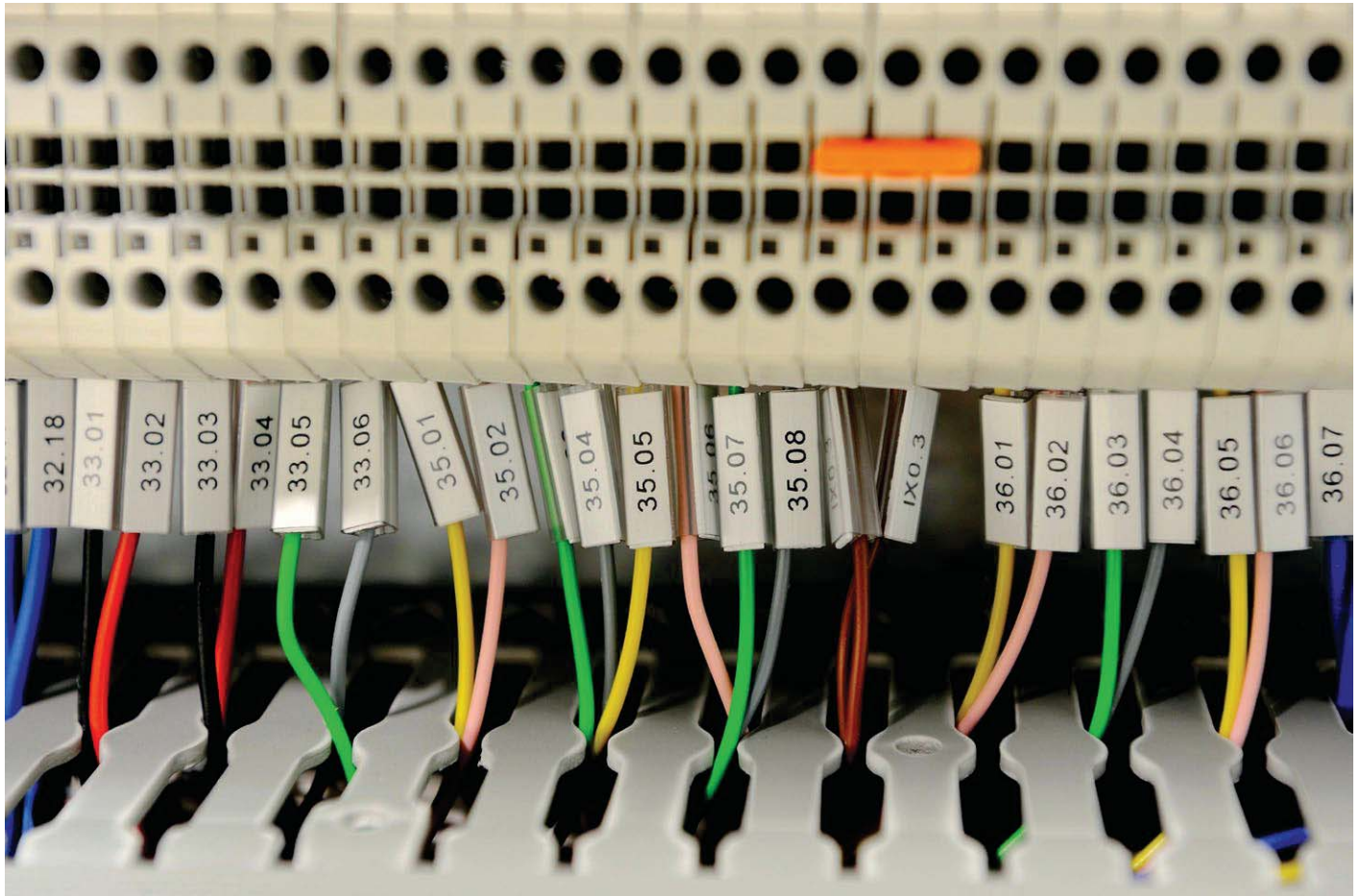

1SNC160210S0201

HTP500 wires and cables markers

Selection guide

For evolutive identification

Marker holders + slide-in markers

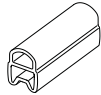

RING

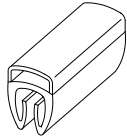

SNAP



Wire external diameter		Marker holder length		Marker holder	Compatible marker
mm	in	mm	in		
Slide-on cable marker holder					
Ø 1.5 ... 2.5	Ø 0.059 ... 0.098	12	0.472	RING122	WMTT 12
		18	0.709	RING182	WMTT 18
Ø 2 ... 4	Ø 0.079 ... 0.157	12	0.472	RING124	WMTT 12
		18	0.709	RING184	WMTT 18
Ø 4 ... 7	Ø 0.157 ... 0.276	12	0.472	RING127	WMTT 12
		18	0.709	RING187	WMTT 18
Ø 6 ... 10	Ø 0.236 ... 0.394	12	0.472	RING1210	WMTT 12
		18	0.709	RING1810	WMTT 18
Clip-on cable marker holder					
Ø 2 ... 3.5	Ø 0.079 ... 0.138	15	0.591	SNAP152	WMTT 12
		23	0.906	SNAP232	WMTT 18
Ø 2.8 ... 5	Ø 0.11 ... 0.197	15	0.591	SNAP154	WMTT 12
		23	0.906	SNAP234	WMTT 18
Ø 5 ... 8	Ø 0.197 ... 0.315	15	0.591	SNAP157	WMTT 12
		23	0.906	SNAP237	WMTT 18
Ø 8 ... 10	Ø 0.315 ... 0.394	15	0.591	SNAP1510	WMTT 12
		23	0.906	SNAP2310	WMTT 18

For identification of thick tubes

Tie-on markers / marker holders

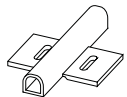

RINGT23

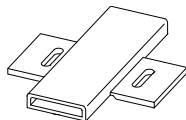

RINGT209



Marker holder length		Marker holder	Compatible marker
mm	in		
23	23	RINGT23	WMTT 18
28	28	RINGT209	PCGS209

WMTT wire and cable markers

Slide-in precut blank labels



1SNC700183F000

WMTT12

Description

- Blank marker card for wire and cable identification,
- Markers are protected in the marker holders,
- To be slid into RING or SNAP transparent holders,
- Made of rigid polycarbonate.

Main technical data

Material	Flammability	Temperature range
Polycarbonate	V0	-50°C to +80°C -58°F to +176°F

Ordering details

Dimensions		Maximum printed digits		Nb. of markers per card	Color	Type	Part Number	Pkg card	Weight (1 card) g
mm	in	Hor.	Vert.						

WMTT12

12 mm 0.472 in markers (for RING or SNAP holders)

12 x 4	0.472 x 0.157	2	8	30	White	<input type="checkbox"/>	WMTT12	1SNA235093R1400	32	6.70
--------	---------------	---	---	----	-------	--------------------------	--------	-----------------	----	------

WMTT18

18 mm 0.709 in markers

18 x 4	0.709 x 0.157	2	10	18	White	<input type="checkbox"/>	WMTT18	1SNA235094R1500	32	7.00
--------	---------------	---	----	----	-------	--------------------------	--------	-----------------	----	------

Marking system accessories

HTP500-PL

Support plate

Included in the HTP500-V2 kit						<input type="checkbox"/>	HTP500-PL	1SNA235704R0500	1	294.00
-------------------------------	--	--	--	--	--	--------------------------	-----------	-----------------	---	--------



Compatible holders



RING

Sealed transparent holder



SNAP

Unsealed transparent holder



RINGT23

Tie-on sealed transparent holder

RING, SNAP transparent marker holders

For WMTT markers



1SNC160251F0014

Description

- Transparent marker holder profiled to allow marking on various cable sizes, up to \varnothing 10 mm 0.394 in,
- Use with WM and WMTT markers,
- Made of PVC.

Main technical data

Material	Flammability	Temperature range
PVC	V0	-50°C to +80°C -58°F to +176°F

Ordering details

Wire ext. diameter		Wire section mm ²	Holder length		Color	Type	Part Number	Pkg pce	Weight (1 pce) g
mm	in		mm	in					

For cable mounting

RING



RING

12 mm 0.472 in sealed transparent holder for WM12 and WMTT12 markers

1.5 ... 2.5	0.059 ... 0.098		12	0.472	Transparent	<input checked="" type="checkbox"/>	RING122	1SNA235117R1000	3000	1.80
2 ... 4	0.079 ... 0.157				Transparent	<input checked="" type="checkbox"/>	RING124	1SNA235118R2100	3000	2.20
4 ... 7	0.157 ... 0.276				Transparent	<input checked="" type="checkbox"/>	RING127	1SNA235119R2200	2000	0.30
6 ... 10	0.236 ... 0.394				Transparent	<input checked="" type="checkbox"/>	RING1210	1SNA235120R2700	2000	0.50

18 mm 0.709 in sealed transparent holder for WM18 and WMTT18 markers

1.5 ... 2.5	0.059 ... 0.098		18	0.709	Transparent	<input checked="" type="checkbox"/>	RING182	1SNA235123R1600	3000	0.30
2 ... 4	0.079 ... 0.157				Transparent	<input checked="" type="checkbox"/>	RING184	1SNA235124R1700	3000	0.30
4 ... 7	0.157 ... 0.276				Transparent	<input checked="" type="checkbox"/>	RING187	1SNA235125R1000	2000	0.50
6 ... 10	0.236 ... 0.394				Transparent	<input checked="" type="checkbox"/>	RING1810	1SNA235126R1100	1000	0.70

SNAP



SNAP

12 mm 0.472 in un-sealed transparent holder for WM12 and WMTT12 markers

2 ... 3.5	0.079 ... 0.138		15	0.591	Transparent	<input checked="" type="checkbox"/>	SNAP152	1SNA235129R2400	1000	0.40
2.8 ... 5	0.110 ... 0.197				Transparent	<input checked="" type="checkbox"/>	SNAP154	1SNA235130R2100	1000	0.40
5 ... 8	0.197 ... 0.315				Transparent	<input checked="" type="checkbox"/>	SNAP157	1SNA235131R1600	500	0.50
8 ... 10	0.315 ... 0.394				Transparent	<input checked="" type="checkbox"/>	SNAP1510	1SNA235132R1700	500	1.40

23 mm 0.906 in un-sealed transparent holder for WM18 and WMTT18 markers

2 ... 3.5	0.079 ... 0.138		23	0.906	Transparent	<input checked="" type="checkbox"/>	SNAP232	1SNA235133R1000	500	0.40
2.8 ... 5	0.110 ... 0.197				Transparent	<input checked="" type="checkbox"/>	SNAP234	1SNA235134R1100	500	0.60
5 ... 8	0.197 ... 0.315				Transparent	<input checked="" type="checkbox"/>	SNAP237	1SNA235135R1200	200	0.90
8 ... 10	0.315 ... 0.394				Transparent	<input checked="" type="checkbox"/>	SNAP2310	1SNA235136R1300	200	2.20

For thick tube mounting

RINGT23



RINGT23

23 mm 0.906 in tie-on sealed transparent holder for WM and WMTT markers

			23	0.906	Transparent	<input checked="" type="checkbox"/>	RINGT23	1SNA235137R1400	200	0.40
--	--	--	----	-------	-------------	-------------------------------------	---------	-----------------	-----	------

Use holders only with designated cable marker of the same or a shorter length.

2

1SNC160194S0201



PCGS wire and cable markers

Slide-in precut blank labels

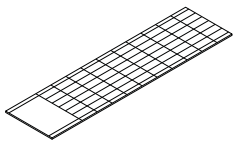

1SNCT00181F000

PCGS209

Description

- Blank marker card for thick wires,
- To be inserted in RINGT209 holder,
- Made of PVC.

Main technical data

Material	Flammability	Temperature range
PVC	V0	-40°C to +60°C -40°F to +140°F

Ordering details

Dimensions	Nb. of markers per card	Color	Type	Part Number	Pkg	Weight
mm in					card	(1 card) g

PCGS

For RINGT holders

20 x 9.3	0.787 x 0.366	60	White <input type="checkbox"/>	PCGS209	1SNA235150R0500	40	10.00
----------	---------------	----	--------------------------------	---------	-----------------	----	-------

Marking system accessories

HTP500-PL

Support plate

Included in the HTP500-V2 kit				HTP500-PL	1SNA235704R0500	1	294.00
-------------------------------	--	--	--	-----------	-----------------	---	--------



RINGT209 transparent marker holders

For PCGS markers



1SNC160100F0014

RINGT209

Description

- Transparent tie-on marker holders profiled to allow thick tube identification,
- Use with PCGS209 markers,
- Made of PVC.

Main technical data

Material	Flammability	Temperature range
PVC	V0	-50°C to +80°C -58°F to +176°F

Ordering details

Dimensions	Color	Type	Part Number	Pkg	Weight
mm in				pce	(1 pce) g

For thick tube mounting

RINGT209

Tie-on sealed transparent holder for PCGS markers

9.5 x 20	0.374 x 0.787	Transparent <input checked="" type="checkbox"/>	RINGT209	1SNA235142R2100	240	6.00
----------	---------------	---	----------	-----------------	-----	------

Use holders only with designated cable marker of the same or a shorter length.
Dimensions given apply to the labelling area.

RPA-TT, PIB2-TT component and equipment markers

Self-adhesive precut blank labels

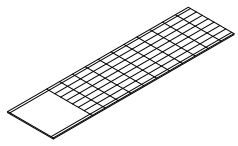

RPA-TT

1SNC160235F0014

Description

- Self-adhesive labels for general purpose,
- High performance adhesive compatible with most surface types.

Main technical data

Material	Flammability
PVC + Adhesive acrylic	V0

Ordering details

Dimensions	Nb. of markers per card	Color	Type	Part Number	Pkg	Weight
mm in					card	(1 card) g

RPA-TT

Card of 77 self-adhesive blank labels

8 x 17.5	0.315 x 0.689	77	White <input type="checkbox"/>	RPA-TT	1SNA235151R2200	25	12.50
			Yellow <input checked="" type="checkbox"/>	RPA-TT-YL	1SNA235152R2300	25	12.10

PIB2-TT

Card of 15 self-adhesive blank labels

35 x 17.5	1.392 x 0.689	15	White <input type="checkbox"/>	PIB2-TT	1SNA235155R2600	25	9.70
			Yellow <input checked="" type="checkbox"/>	PIB2-TT-YL	1SNA235157R2000	25	9.40

Marking system accessories

No support plate needed.
Direct insertion into HTP500 marking system for printing.

Mounting instruction

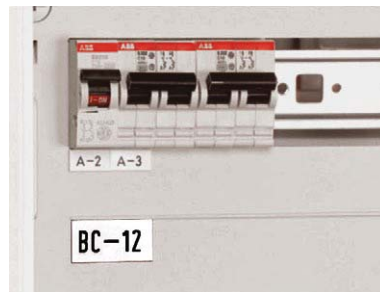

Compatible holders



PEB
(only for PIB2-TT)



PEB end stop label holders

For PIB2-TT labels



1SNC160200F0014

PEB

Description

- To be used for terminal block assembly identification,
- Direct insertion onto end stops from SNA series.

Main technical data

Material	Flammability	Temperature range
Polyamide (PEB) PVC (EPR1)	V0	-55°C to +110°C -67°F to +230°F

Ordering details

Dimensions	Color	Type	Part Number	Pkg	Weight
mm				pce	(1 pce) g

PEB

Label holder for end stop 35 x 17 mm 1.378 x .669 in, to be snapped onto end stop

18 x 35.5	0.709 x 1.378	Grey <input type="checkbox"/>	PEB	1SNA113077R1100	50	1.70
-----------	---------------	-------------------------------	-----	-----------------	----	------

EPR1

Card of 54 PVC protective covers

17.5 x 35	0.689 x 1.378	Transparent <input checked="" type="checkbox"/>	EPR1	1SNA178431R2200	1	0.054
-----------	---------------	---	------	-----------------	---	-------

PEBM

"All in one": PEB marker holder with marker and protection included

			PEBM	1SNA113084R0100	50	2.80
--	--	--	------	-----------------	----	------

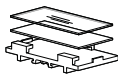
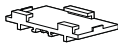

Compatible end stops



BAM2

1SNA206351R1600



BADL

1SNA399903R0200



BADH

1SNA116900R2700



BAMH

1SNA114836R0000



BAR

1SNA164519R2400



BADRL

1SNA199420R2100

PAM component and equipment markers

Self-adhesive precut blank labels

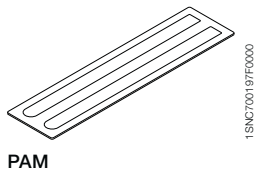

Description

- Self-adhesive blank labels used to identified different components and equipments in a cabinet,
- Can be used directly on equipment or with a label holder.

Main technical data

Material	Flammability	Temperature range
PVC	V0	-40°C to +60°C -40°F to +140°F

Ordering details

Dimensions		Nb. of markers per card	Color	Type	Part Number	Pkg card	Weight (1 card) g
mm	in						

PAM

Self-adhesive blank label compatible with PAM100015 and PCT100015 transparent cover

15 x 215	0.591 x 8.465	2	White <input type="checkbox"/>	PAM21515	1SNA235103R2300	20	12.00
15 x 430	0.591 x 16.930		White <input type="checkbox"/>	PAM43015	1SNA235104R2400	20	22.00

Self-adhesive blank label

20 x 215	0.787 x 8.465	2	White <input type="checkbox"/>	PAM21520	1SNA235105R2500	20	14.00
20 x 430	0.787 x 16.930		White <input type="checkbox"/>	PAM43020	1SNA235106R2600	20	27.00

Marking system accessories

No support plate needed.
Direct insertion into HTP500 marking system for printing.

Compatible holders

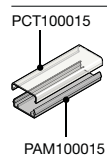

Protective cover and self-adhesive marking profile
(only for PAM21515 and PAM43015)

15NC160196S0201



BA4 component and equipment markers

Precut blank label



1SNC16010F0014

Description

- Precut blank label used to identify contactors, overload relays and manual motor starters,
- Compatible with: AF09 ... AF370 contactors, TF thermal overload relays, EF electronic overload relays, and MS116, MS132 manual motor starters.

Main technical data

Material	Flammability
Polycarbonate	V0

Ordering details

Dimensions	Color	Type	Part Number	Pkg	Weight
mm	in			card	(1 card) g
BA4					
Card of 16 blank labels					
7 x 20	0.276 x 0.787	White <input type="checkbox"/>	BA4	1SNA235156R2700	16 11.00

Marking system accessories

HTP500-BA4

Support plate for AMS600

Purchased separately		HTP500-BA4	1SNA235712R2400	1	290.00
----------------------	--	------------	-----------------	---	--------

Mounting instruction



2

1SNC160205S0201 - Rev. B

PPB component and equipment markers

Two-colored precut blank labels

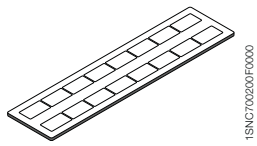

1SNC160197S0201

PPB

Description

- Two-colored blank label cards, white side / black side,
- For push button or sub-assembly identification,
- To be used with a label holder.

Main technical data

Material	Flammability	Temperature range
MMA	HB	-40°C to +82°C -40°F to +180°F

Ordering details

Dimensions		Nb. of markers per card	Color	Type	Part Number	Pkg card	Weight (1 card) g
mm	in						
PPB							
15 x 27	0.591 x 1.063	16	White and Black	PPB2715	1SNA235111R1200	12	13.30

Marking system accessories

No support plate needed.
Direct insertion into HTP500 marking system for printing.

Compatible holders

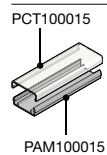

Protective cover and self-adhesive marking profile



KA1-8120
Push button marker holder



PAM100015, PCT, KA marker holders

For PAM21515, PAM43015 and PPB labels



1SNIC160268F0014

Description

- For component and equipment identification,
- Self-adhesive marking profile (PAM), transparent cover (PCT) and push-button marker holder (KA1).

Main technical data

Material	Flammability	Temperature range
PVC (for PAM and PCT) Polycarbonate (for KA1)	V0 (for PAM and PCT) V2 (for KA1)	-10°C to +70°C +14°F to +158°F (for PAM and PCT) -25°C to +70°C -13°F to +158°F (for KA1)

Ordering details

Dimensions	Color	Type	Part Number	Pkg	Weight
mm				pce	(1 pce) g

Push-button marker holder



KA1-8120

KA1

Push button marker holder for PPB markers

15 x 27	0.591 x 1.063	Black ■	KA1-8120	1SFA616920R8120	10	2.00
---------	---------------	---------	----------	-----------------	----	------

Self-adhesive marking profile for PAM and PPB markers

PCT

Transparent cover for PAM100015

15 x 1000	0.591 x 39.370	Transparent ☑	PCT100015	1SNA235147R2600	35	34.00
-----------	----------------	---------------	-----------	-----------------	----	-------

PAM100015

Adhesive marking profile

15 x 1000	0.591 x 39.370	Black ■	PAM100015	1SNA235146R2500	35	40.00
-----------	----------------	---------	-----------	-----------------	----	-------

Dimensions given apply to the labelling area.

PCT100015

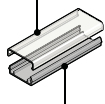

PAM100015



PAT panel plates

Self-adhesive blank panel plates

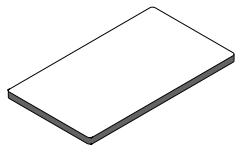

1SNC700214F0000

PAT

Description

- Self-adhesive blank plate for identification of electrical boxes or cabinets.

Main technical data

Material	Flammability	Temperature range
PVC	V0	-40°C to +120°C -40°F to +248°F

Ordering details

Dimensions		Nb. of markers per card	Color	Type	Part Number	Pkg	Weight
mm	in						

PAT

Adhesive plate for external marking

60 x 100	2.262 x 3.937	1	White <input type="checkbox"/>	PAT10060	1SNA235114R1500	15	5.30
----------	---------------	---	--------------------------------	----------	-----------------	----	------

Marking system accessories

No support plate needed.
Direct insertion into HTP500 marking system for printing.

PPT panel plates

Blank panel plates

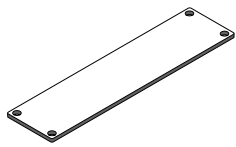

1SNC700215F0000

PPT

Description

- Blank perforated plate for identification of electrical boxes or cabinets,
- To be fixed with rivets.

Main technical data

Material	Flammability	Temperature range
MMA	HB	-40°C to +82°C -40°F to +180°F

Ordering details

Dimensions		Nb. of markers per card	Color	Type	Part Number	Pkg	Weight
mm	in						

PPT

Perforated blank plate

30 x 120	1.181 x 4.724	1	White <input type="checkbox"/>	PPT12030	1SNA235115R1600	50	3.50
50 x 180	1.969 x 7.087		White <input type="checkbox"/>	PPT18050	1SNA235116R1700	30	8.80

Marking system accessories

No support plate needed.
Direct insertion into HTP500 marking system for printing.

Mounting instruction

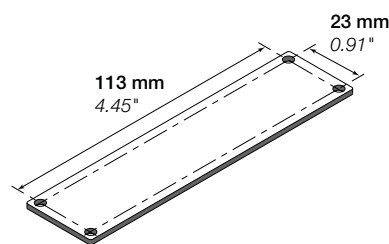

1SNC160196S0201



Solution series

Blank markers and labels for MG3 thermal transfer printer

MG3 thermal transfer printer	38
Support plates overview	40
MG3 kit and accessories	41



Terminal block identification

Selection guide for terminal block markers	42									
Terminal block markers	<table> <tr> <td>MG-CPM-13</td> <td>for SNK series</td> <td>44</td> </tr> <tr> <td>MG-CPM-...</td> <td>for SNA and Solution series</td> <td>44</td> </tr> <tr> <td>MG-CPMF...</td> <td>strip labels</td> <td>45</td> </tr> </table>	MG-CPM-13	for SNK series	44	MG-CPM-...	for SNA and Solution series	44	MG-CPMF...	strip labels	45
MG-CPM-13	for SNK series	44								
MG-CPM-...	for SNA and Solution series	44								
MG-CPMF...	strip labels	45								
Other manufacturers' terminal block markers	MG-CPM-... 46									
End stop markers	<table> <tr> <td>MG-TAA</td> <td>62</td> </tr> <tr> <td>RC810TT</td> <td>48</td> </tr> <tr> <td>MG-TAR</td> <td>70</td> </tr> </table>	MG-TAA	62	RC810TT	48	MG-TAR	70			
MG-TAA	62									
RC810TT	48									
MG-TAR	70									
End stop label holders and covers	<table> <tr> <td>LH, LH-R1</td> <td>for SNK series</td> <td>49</td> </tr> <tr> <td>PEB, PEBM, EPR1</td> <td>for SNA and Solution series</td> <td>50</td> </tr> <tr> <td>PEAD, EPR2</td> <td>for SNA and Solution series</td> <td>51</td> </tr> </table>	LH, LH-R1	for SNK series	49	PEB, PEBM, EPR1	for SNA and Solution series	50	PEAD, EPR2	for SNA and Solution series	51
LH, LH-R1	for SNK series	49								
PEB, PEBM, EPR1	for SNA and Solution series	50								
PEAD, EPR2	for SNA and Solution series	51								



Wire and cable identification

Selection guide for wire and cable markers	52															
Wire and cable markers	<table> <tr> <td>MG-TDM</td> <td>slide-on cable markers</td> <td>54</td> </tr> <tr> <td>MG2-TDMO</td> <td>clip-on cable markers</td> <td>55</td> </tr> <tr> <td>MG-ETF</td> <td>tie-on cable markers</td> <td>57</td> </tr> <tr> <td>MG-TPM</td> <td>ABS cable markers (need label holder)</td> <td>58</td> </tr> <tr> <td>MG-TPMF</td> <td>PVC cable markers (need label holder)</td> <td>60</td> </tr> </table>	MG-TDM	slide-on cable markers	54	MG2-TDMO	clip-on cable markers	55	MG-ETF	tie-on cable markers	57	MG-TPM	ABS cable markers (need label holder)	58	MG-TPMF	PVC cable markers (need label holder)	60
MG-TDM	slide-on cable markers	54														
MG2-TDMO	clip-on cable markers	55														
MG-ETF	tie-on cable markers	57														
MG-TPM	ABS cable markers (need label holder)	58														
MG-TPMF	PVC cable markers (need label holder)	60														
Wire and cables label holders	<table> <tr> <td>UMH</td> <td>56</td> </tr> <tr> <td>PM, PM-ET, PM-AC</td> <td>transparent label holder for MG-TPM</td> <td>59</td> </tr> <tr> <td>PMF, PMF-ET, PMF-AC</td> <td>transparent label holder for MG-TPMF</td> <td>61</td> </tr> </table>	UMH	56	PM, PM-ET, PM-AC	transparent label holder for MG-TPM	59	PMF, PMF-ET, PMF-AC	transparent label holder for MG-TPMF	61							
UMH	56															
PM, PM-ET, PM-AC	transparent label holder for MG-TPM	59														
PMF, PMF-ET, PMF-AC	transparent label holder for MG-TPMF	61														

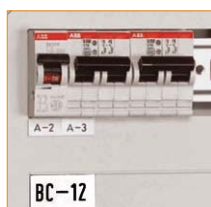

Component and equipment identification

Self-adhesive labels	<table> <tr> <td>MG-TAA</td> <td>62</td> </tr> <tr> <td>MG-VYT</td> <td>for dielectric requirements</td> <td>63</td> </tr> <tr> <td>MG-17.5A</td> <td>for strip identification</td> <td>64</td> </tr> <tr> <td>MG-PTS</td> <td>for push-button identification</td> <td>65</td> </tr> </table>	MG-TAA	62	MG-VYT	for dielectric requirements	63	MG-17.5A	for strip identification	64	MG-PTS	for push-button identification	65			
MG-TAA	62														
MG-VYT	for dielectric requirements	63													
MG-17.5A	for strip identification	64													
MG-PTS	for push-button identification	65													
Pre-cut labels	<table> <tr> <td>MG-TAP</td> <td>66</td> </tr> <tr> <td>MG-TAPW</td> <td>9 mm width label</td> <td>68</td> </tr> <tr> <td>MG-TAP-CCS</td> <td>transparent label</td> <td>69</td> </tr> <tr> <td>MG-TAR</td> <td>17 mm width label</td> <td>70</td> </tr> <tr> <td>MG-PLC</td> <td>for PLC's identification</td> <td>71</td> </tr> </table>	MG-TAP	66	MG-TAPW	9 mm width label	68	MG-TAP-CCS	transparent label	69	MG-TAR	17 mm width label	70	MG-PLC	for PLC's identification	71
MG-TAP	66														
MG-TAPW	9 mm width label	68													
MG-TAP-CCS	transparent label	69													
MG-TAR	17 mm width label	70													
MG-PLC	for PLC's identification	71													
Label holders and covers	<table> <tr> <td>RTR-TAP</td> <td>15 mm pre-drilled rail</td> <td>67</td> </tr> <tr> <td>RTA-TAP</td> <td>15 mm self-adhesive rail</td> <td>67</td> </tr> <tr> <td>RT-CCP</td> <td>15 mm protective cover</td> <td>67</td> </tr> <tr> <td>RTA-TAPW</td> <td>9 mm self-adhesive rail</td> <td>68</td> </tr> </table>	RTR-TAP	15 mm pre-drilled rail	67	RTA-TAP	15 mm self-adhesive rail	67	RT-CCP	15 mm protective cover	67	RTA-TAPW	9 mm self-adhesive rail	68		
RTR-TAP	15 mm pre-drilled rail	67													
RTA-TAP	15 mm self-adhesive rail	67													
RT-CCP	15 mm protective cover	67													
RTA-TAPW	9 mm self-adhesive rail	68													



Panel identification

Self-adhesive panel plates	MG-VRT-A	72
Rivet fixing panel plates	MG-VRT-R	72

Other manufacturers markers selection guide	158
---	-----



The versatile, compact and robust marking system

MARKINGGenius® MG3 is a high resolution printer based on thermal transfer technology for producing high quality identification and labelling for terminal blocks, cables and all equipment mounted in electrical panels.

Compact, ergonomic, clean and quiet, MARKINGGenius® MG3 may be conveniently located in an office or workshop or easily transported in the field.

Thermal transfer technology uses heat to transfer characters or symbols onto a plastic marker through an ink ribbon. Besides the excellent printing quality, there is no drying time and the markers are instantly usable.

With the MG3 thermal transfer printer, forget about drying times and clogged print head problems.

Combined simplicity, performance and make savings

Facilitate your printing process

Compact design (382 x 230 x 230 mm) facilitates use in workshops or in the field.

Easy to install and use: comprehensive quick-start kit. Intuitive software with easy data import and entry.

Versatile: many different media available: plastic markers, stickers, labels etc.

Save time and consumables

Gain time with a short printing process:

12 seconds cycle. Carriage loading and unloading operation is fast and simple.

Economic: up to 300 000 markers with one ribbon. Partially printed marker card may be reused to avoid wastage.

No drying time: printed markers are immediately ready to use.

Experience quality

High Quality printing: 300 x 600 dpi for image or graphic printing.

Robust: all moving parts are in metal.



High quality printing



Short printing cycle of 12 seconds



Economic: up to 300 000 markers with one ribbon



Many media types available for printing

MG3 thermal transfer printer

Components of the kit

The MG3 printer is delivered with a comprehensive set of accessories for getting started quickly

Kit (Part number: 1SNB419001R0000) including:

- 1 Thermal transfer printer
- 1 Software CD
- 1 Power supply cable
- 1 USB cable
- 1 Installation, operating, maintenance and user documentation
- 1 Protective cover
- 1 Ribbon take up spool
- 1 MG2-QTB support plate for terminal block markers (MG-CPM-01, 02, 03, 04, 07)
- 1 MG2-PWC support plate for wire and cable markers (MG-TPM)
- 1 MG2-PLT support plate for wire and cable markers (MG-TPMF) and various labels and signs
- 1 MG2-ETB Support plate for SNK series terminal block markers (MG-CPM-13)
- 1 MG2-ETR Black printing ribbon.

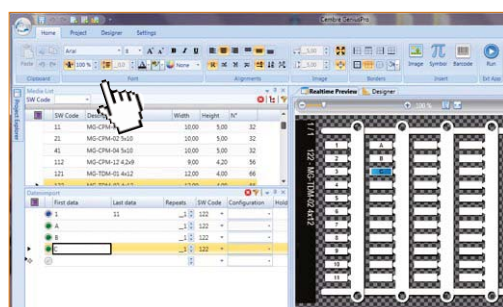

Genius Pro software

The Genius Pro software application benefits from long experience in the field and requires the operator to have only basic skills in order to use it. It is application-oriented and provides fast and easy data entry including a dynamic full-size media preview giving an accurate representation of the current job.

Features / characteristics:





- More than ten types of counter such as *.txt, *.cad, *.dbf, *.xls can be imported
- AutoCAD, Elcad, Spac and Excel import
- MATRIX, ACS and Simplo conversion

- Optimised printing of media for cables, terminal blocks, control gear, connectors, push buttons, components, panels and self-adhesive labels
- Specially developed proprietary Genius font and also Windows fonts
- Designs customised media
- Vector, drawing and clip art printing
- Free upgrades for each new release
- Microsoft® Windows® XP, Windows Vista®, Windows 2000 SP4®, Windows 7®.







MG3 thermal transfer printer

Find out quickly which support plate your printing job needs

Support plates included in MG3 Kit

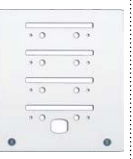
					
Support plate type		MG2-PWC	MG2-PLT	MG2-QTB	MG2-ETB
Markers and labels compatibles					
Terminal block markers	MG-CPM-01 (except 5x7 mm)			●	
	MG-CPM-02			●	
	MG-CPM-03			●	
	MG-CPM-04			●	
	MG-CPM-07			●	
	MG-CPM-13				●
Terminal block marker strips	MG-CPMF		●		
	MG-CPMFA		●		
Tie-on cable labels	MG-ETF		●		
Slide-in cable markers	MG-TPM	●			
Slide-in cable markers	MG-TPMF		●		
Labels	MG-TAR		●		
Labels	MG-TAP		●		
Labels 9 mm	MG-TAPW		●		
CCS Transparent markers	MG-TAP		●		
Self-adhesive labels	MG-TAA		●		
Self adhesive labels	MG-VYT		●		
PLC labels	MG-PLC		●		
Modular self-adhesive labels	MG-17.5		●		
Push button labels	MG-PTS		●		
Panel plates	MG-VRT		●		

Support plates to be purchased separately

								
Support plate type		MG2-PTD	MG2-PTM	MG2-WTB	MG2-STB	MG2-CTB	MG2-MTB	MG2-LTB
Markers and labels compatibles								
Terminal block markers	MG-CPM-01 (5x7 mm only)						●	
	MG-CPM-05			●				
	MG-CPM-06				●			
	MG-CPM-09							●
	MG-CPM-10					●		
	MG-CPM-12			●				
Slide-on cable markers	MG-TDM	4x12 mm	4x16 mm					
Clip-on cable markers	MG2-TDMO		●					

MG3 thermal transfer printer

Kit and accessories



MG3 KIT

Description

- Versatile,
- Compact and robust,
- Easy to install and use.

Ordering details

Description	Color	Type	Part Number	Pkg pce	Weight (1 pce) g
MG3 Thermal transfer printer KIT		MG3 KIT	1SNB419001R0000	1	12600.00
List of items included in the KIT:					
1 MG3 Thermal transfer printer		MG3			
1 Software CD		MG3 SOFTWARE			
1 Power supply cable		MG3 POWER			
1 USB cable		MG3 USB			
1 Protective cover		MG2 COVE 991680			
1 Ribbon take up spool		MG2-CRB 991654			
1 Black monochrome ribbon		MG2-ETR 991600			
1 Support plate for cable tags MG-TPM		MG2-PWC 991000			
1 Support plate for labels, cables, plates and various markers		MG2-PLT 991002			
1 Support plate for terminal block markers MG-CPM-01(5x10 and 5x15),02,03,04,07		MG2-QTB 991011			
1 Support plate for SNK series terminal block markers (MG-CPM-13)		MG2-ETB 991016			



Support plate MG2-...

Support plates

Description	Color	Type	Part Number	Pkg pce	Weight (1 pce) g
Support template for:					
Cable tags MG-TPM		MG2-PWC 991000	1SNB991000R0000	1	148.00
Labels, cable tags, plates and various markers		MG2-PLT 991002	1SNB991002R0000	1	148.00
Terminal block markers MG-CPM-05,12		MG2-WTB 991004	1SNB991004R0000	1	151.00
Terminal block markers MG-CPM-06		MG2-STB 991005	1SNB991005R0000	1	158.00
Terminal block markers MG-CPM-10		MG2-CTB 991006	1SNB991006R0000	1	156.00
Cable tags MG-TDM (4x12 mm)		MG2-PTD 991007	1SNB991007R0000	1	126.00
Terminal block markers MG-CPM-01 (5x7 mm)		MG2-MTB 991008	1SNB991008R0000	1	149.00
Cable tags MG2-TDMO and MG-TDM (4x16 mm)		MG2-PTM 991010	1SNB991010R0000	1	116.00
Terminal block markers MG-CPM-01 (5x10 and 5x15 mm),02,03,04,07		MG2-QTB 991011	1SNB991011R0000	1	120.00
Terminal block markers TE Connectivity RC and MC series		MG2-ABM 991012	1SNB991012R0000	1	146.00
Terminal block markers MG-CPM-09		MG2-LTB 991013	1SNB991013R0000	1	128.00
Terminal block markers SNK series MG-CPM-13		MG2-ETB 991016	1SNB991016R0000	1	100.00

PET blank cover for support plate

Description	Color	Type	Part Number	Pkg pce	Weight (1 pce) g
PET blank for support plate MG2-PWC		MG2-TWC 991502	1SNB991502R0000	3	16.70
PET blank for support plate MG2-PLT		MG2-TLT 991522	1SNB991522R0000	3	14.70
PET blank for support plate MG2-PTD		MG2-TTD 991563	1SNB991563R0000	3	11.70
PET blank for support plate MG2-MTB		MG2-TMT 991513	1SNB991513R0000	3	12.00
PET blank for support plate MG2-WTB		MG2-TWT 991542	1SNB991542R0000	3	12.00
PET blank for support plate MG2-STB		MG2-TST 991552	1SNB991552R0000	3	21.50
PET blank for support plate MG2-CTB		MG2-TCT 991562	1SNB991562R0000	3	12.00
PET blank for support plate MG2-QTB		MG2-TGT 991532	1SNB991532R0000	3	11.70
PET blank for support plate MG2-ETB		MG2-TTB 991512	1SNB991512R0000	3	10.70



Ribbons MG2-ETR...















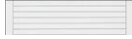



















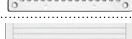

Accessories

Description	Color	Type	Part Number	Pkg pce	Weight (1 pce) g
Print head cleaning kit		MG2-CKP 991670	1SNB991670R0000	1	336.00
Black monochrome ribbon	Black	MG2-ETR 991600	1SNB991600R0000	1	227.00
Blue monochrome ribbon	Blue	MG2-ETR 991601	1SNB991601R0000	1	229.00
Red monochrome ribbon	Red	MG2-ETR 991602	1SNB991602R0000	1	255.00
Green monochrome ribbon	Green	MG2-ETR 991603	1SNB991603R0000	1	247.00
White monochrome ribbon	White	MG2-ETR 991606	1SNB991606R0000	1	333.00

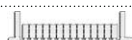
MG3 markers selection guide

Terminal block blank markers selection guide







Terminal blocks (Terminal blocks styles not listed on the chart do not have a marker compatible with this printer)

Connection technology	Terminal block part number	Marker type	Marker mounting
Screw clamp 	1SNK... 	Individual marker (3) 	Top and side marking 
		Adhesive strip label 	Top and side marking 
	1SNA... (1) 	Individual marker (3) 	Side marking 
		Strip marker 	Side marking 
		Strip label 	Side marking 
	PI-Spring 	1SNK... 	Individual marker (3) 
Adhesive strip label 			Top and side marking 
Spring clamp 	1SNA... 	Individual marker (3) 	Top marking 
			Side marking 
		Strip marker 	Side marking 
		Strip label 	Side marking 
Spring loaded screw clamp 	1SNA... 	Individual marker (3) 	Side marking 
		Strip marker 	Side marking 
Pluggable screw clamp 	1SNA... 	Individual marker (3) 	Side marking 





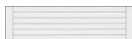







(1) Except mini-blocks.

(3) Can be strip mounted when marker spacing = terminal block spacing.

Special terminal blocks (Terminal blocks styles not listed on the chart do not have a marker compatible with this printer)

D4/6.T...	1SNA...	Strip label 	Side marking 
D2.5/6.D...	1SNA...	Strip label 	Side marking 
D4/6.P.T1	1SNA...	Strip label 	Side marking 

SNK series end stop and label holders

BAZ1 	Individual marker 	Top marking 	MG-CPM 13 41790
BAM4 		Top and side marking 	MG-CPM 13 41791 (6 mm spacing)
LH (label holder for BAM4, BAZH1, BAZ1) 	Label 	Top marking 	MG-TAA 49498
LH-R1 (label holder for BAM4, BAZH1, BAZ1) 			MG-TAA 49198 MG-TAR 45194
UMH (Universal wire markers holder for BAM4, BAZ1) 	Wire marker 	Top marking 	MG2-TDMO













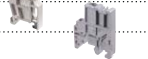



Terminal blocks spacing												
5 mm 0.197 in	5.08 mm 0.200 in	5.2 mm 0.205 in	6 mm 0.236 in	8 mm 0.315 in	10 mm 0.394 in	12 mm 0.472 in	16 mm 0.630 in	22 mm 0.866 in	26 mm 1.024 in	31 mm 1.220 in	36 mm 1.417 in	
		MG-CPM-13 41790	MG-CPM-13 41791	MG-CPM-13 41791 (2)								
		MG-CPMFA 43196										
MG-CPM-03 41291				MG-CPM-04 41390 (2)								
			MG-CPM-04 41391	MG-CPM-04 41396								
MG-CPMF 43090				MG-CPMF 43090								
		MG-CPM-13 41790	MG-CPM-13 41791	MG-CPM-13 41791 (2)								
		MG-CPMFA 43196										
MG-CPM-05 41490				MG-CPM-05 41490 (2)								
MG-CPM-01 41094				MG-CPM-01 41094 (2)								
MG-CPM-12 46391				MG-CPMF 43094								
MG-CPMF 43094				MG-CPM-04 41390 (2)								
			MG-CPM-04 41391									
	MG-CPM-03 41291											

(2) Marker width < marking's area size - markers must be mounted individually.

			MG-CPMF 43094								
			MG-CPMF 43094								
			MG-CPMF 43094								

SNA series end stop and label holders

BAM2, BADL, BADH		Individual marker		Top and side marking		RC810TT
BADRL		Individual marker		Top marking		MG-CPM 04 41391
BAMH		Label		Top marking		RC810TT
PEAD (Label holder for BAM2 and BADL)		Label		Top marking		MG-TAPW 49096
PEB (Label holder for BAM2, BADL, BADH, BAMH, BAR and BADRL)		Label		Top marking		MG-TAA 49198 MG-TAR 45194

MG3 terminal block markers are available in various versions adapted to the usual identification requirements of your terminal blocks.



Individual markers



Strip markers



Strip labels

MG-CPM terminal block markers

Blank markers for SNK, SNA and Solution series

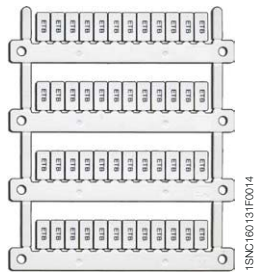

MG-CPM-13

Description

- Available in different versions to suit all terminal block formats,
- Partially printed marker cards may be re-used to avoid wastage,
- Made of halogen free self-extinguishing polycarbonate,
- Refer to MG3 markers' selection guide for terminal blocks and end stop markers to find the suitable marker for your needs.

Main technical data

Material	Flammability	Temperature range
Polycarbonate	V0	-40°C to +140°C -40°F to +284°F

Ordering details

Spacing		Dimensions		Nb. of markers per card	Color	Type	Part Number	SW code	Pkg	Weight
mm	in	mm	in							

SNK series terminal block markers

MG-CPM-13

Individual markers for SNK series terminal blocks, can be strip mounted when marker and terminal block spacing are equal.

5.2	0.205	5 x 12	0.197 x 0.472	56	White <input type="checkbox"/>	MG-CPM-13 41790	1SNB041790R0512	113	1960	0.20
					Yellow <input type="checkbox"/>	MG-CPM-13 41740	1SNB041740R0512	113	1960	0.20
6	0.236	6 x 12	0.236 x 0.472	48	White <input type="checkbox"/>	MG-CPM-13 41791	1SNB041791R0612	114	1680	0.30
					Yellow <input type="checkbox"/>	MG-CPM-13 41741	1SNB041741R0612	114	1680	0.30

Support plate

Included in the MG3 Kit	MG2-ETB 991016	1SNB991016R0000	1	100.00
-------------------------	----------------	-----------------	---	--------

SNA and Solution series terminal block markers

MG-CPM-01

Individual markers, can be strip mounted when marker and terminal block spacing are equal.

5.1	0.201	5 x 7	0.197 x 0.276	56	White <input type="checkbox"/>	MG-CPM-01 41094	1SNB041094R0507	13	1960	0.20
-----	-------	-------	---------------	----	--------------------------------	-----------------	-----------------	----	------	------

Support plate

Purchased separately	MG2-MTB 991008	1SNB991008R0000	1	149.00
----------------------	----------------	-----------------	---	--------

MG-CPM-03

Individual markers, can be strip mounted when marker and terminal block spacing are equal.

5	0.197	5 x 10	0.197 x 0.394	56	White <input type="checkbox"/>	MG-CPM-03 41291	1SNB041291R0510	25	1960	0.20
---	-------	--------	---------------	----	--------------------------------	-----------------	-----------------	----	------	------

Support plate

Included in the MG3 Kit	MG2-QTB 991011	1SNB991011R0000	1	120.00
-------------------------	----------------	-----------------	---	--------

MG-CPM-04

Individual markers, can be strip mounted when marker and terminal block spacing are equal.

8	0.315	5 x 10	0.197 x 0.394	32	White <input type="checkbox"/>	MG-CPM-04 41390	1SNB041390R0510	42	1680	0.30
					Yellow <input type="checkbox"/>	MG-CPM-04 41340	1SNB041340R0510	42	1680	0.40

Strip markers

6	0.236	6 x 10	0.236 x 0.394	48	White <input type="checkbox"/>	MG-CPM-04 41391	1SNB041391R0610	45	1344	0.20
8	0.315	8 x 10	0.315 x 0.394	36		MG-CPM-04 41396	1SNB041396R0810	48	1120	

Support plate

Included in the MG3 Kit	MG2-QTB 991011	1SNB991011R0000	1	120.00
-------------------------	----------------	-----------------	---	--------

MG-CPM-05

Individual markers

5	0.197	5 x 10	0.197 x 0.394	56	White <input type="checkbox"/>	MG-CPM-05 41490	1SNB041490R0510	51	1960	0.40
---	-------	--------	---------------	----	--------------------------------	-----------------	-----------------	----	------	------

Support plate

Purchased separately	MG2-WTB 991004	1SNB991004R0000	1	151.00
----------------------	----------------	-----------------	---	--------

MG-CPM-12

Flexible pitch strip markers

5 ... 6	0.197 ... 0.236	4.2 x 9	0.165 x 0.354	56	White <input type="checkbox"/>	MG-CPM-12 46390	1SNB046390R4209	112	1960	0.20
---------	-----------------	---------	---------------	----	--------------------------------	-----------------	-----------------	-----	------	------

Support plate

Purchased separately	MG2-WTB 991004	1SNB991004R0000	1	151.00
----------------------	----------------	-----------------	---	--------

Refer to selection page for information on strip markers.



MG-CPMF terminal block markers

Blank strip labels for SNK, SNA and Solution series



MG-CPMF

Description

- To be directly used on terminal block assembly,
- Available in precut or self-adhesive versions to fit all applications.

Main technical data

Material	Flammability	Temperature range
Rigid PVC	V0	-30°C to +80°C -22°F to +176°F

Ordering details

Dimensions	Nb. of markers per card	Color	Type	Part Number	SW code	Pkg	Weight
mm : in						marker	(1 marker) g

SNA and Solution series terminal block markers

MG-CPMF

Strip labels for all terminal blocks from the SNA and Solution series

5.2 x 105	0.205 x 4.134	20	White <input type="checkbox"/>	MG-CPMF 43094	1SNB043094R0052	551	1000	0.30
7.6 x 105	0.299 x 4.134	12	White <input type="checkbox"/>	MG-CPMF 43091	1SNB043091R0076	652	600	1.00
10 x 105	0.394 x 4.134	10	White <input type="checkbox"/>	MG-CPMF 43090	1SNB043090R0010	630	500	1.20

SNK series terminal block markers

MG-CPMFA

Self-adhesive strip labels for all terminal blocks from the SNK series

12 x 105	0.472 x 4.134	8	White <input type="checkbox"/>	MG-CPMFA 43196	1SNB043196R0012	330	400	2.60
			Yellow <input type="checkbox"/>	MG-CPMFA 43146	1SNB043146R0012	330	400	2.60

Component and equipment markers

MG-CPMFA

Self-adhesive strip labels for various applications

10 x 105	0.394 x 4.134	10	White <input type="checkbox"/>	MG-CPMFA 46990	1SNB046990R0010	530	100	6.23
----------	---------------	----	--------------------------------	----------------	-----------------	-----	-----	------

Marking system accessories

MG2-PLT

Support plate

Included in the MG3 Kit				MG2-PLT 991002	1SNB991002R0000		1	148.50
-------------------------	--	--	--	----------------	-----------------	--	---	--------

Mounting instruction

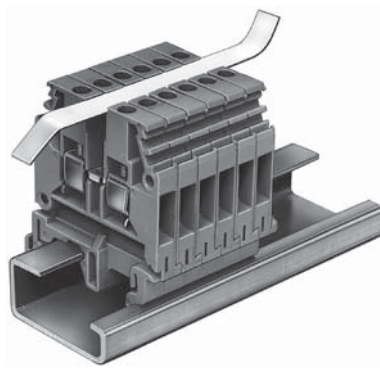

MG-CPM terminal block markers

Blank markers for other manufacturers

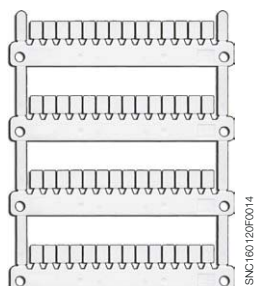

MG-CPM-01

Description

- Available in different versions to suit other manufacturers terminal block formats,
- Partially printed marker cards may be re-used to avoid wastage,
- Made of halogen free self-extinguishing polycarbonate,
- Refer to MG3 markers' selection guide for other manufacturer terminal blocks and end stop markers to find the suitable marker for your needs.

Main technical data

Material	Flammability	Temperature range
Polycarbonate	V0	-40°C to +140°C -40°F to +284°F

Ordering details

Spacing		Dimensions		Nb. of markers per card	Color	Type	Part Number	SW code	Pkg	Weight
mm	in	mm	in							

MG-CPM-01

Individual markers

5.1	0.201	5 x 10	0.197 x 0.394	56	White <input type="checkbox"/>	MG-CPM-01 41090N	1SNB041090R0510	14	1960	0.20
		5 x 15	0.197 x 0.591		White <input type="checkbox"/>	MG-CPM-01 41091N	1SNB041091R0515	16	1680	0.20

Support plate

Included in the MG3 Kit						MG2-QTB 991011	1SNB991011R0000		1	120.00
-------------------------	--	--	--	--	--	----------------	-----------------	--	---	--------

Individual markers

5.1	0.201	5 x 7	0.197 x 0.276	56	White <input type="checkbox"/>	MG-CPM-01 41094	1SNB041094R0507	13	1960	0.20
-----	-------	-------	---------------	----	--------------------------------	-----------------	-----------------	----	------	------

Support plate

Purchased separately						MG2-MTB 991008	1SNB991008R0000		1	149.00
----------------------	--	--	--	--	--	----------------	-----------------	--	---	--------

MG-CPM-02

Individual markers

5.1	0.201	5 x 10	0.197 x 0.394	56	White <input type="checkbox"/>	MG-CPM-02 41190N	1SNB041190R0510	22	1680	0.40
					Yellow <input type="checkbox"/>	MG-CPM-02 41140N	1SNB041140R0510	22	1680	0.40

Support plate

Included in the MG3 Kit						MG2-QTB 991011	1SNB991011R0000		1	120.00
-------------------------	--	--	--	--	--	----------------	-----------------	--	---	--------

MG-CPM-03

Individual markers

5	0.197	5 x 10	0.197 x 0.394	56	White <input type="checkbox"/>	MG-CPM-03 41291	1SNB041291R0510	25	1960	0.20
					White <input type="checkbox"/>	MG-CPM-03 41293	1SNB041293R0510	25	1960	0.20

Support plate

Included in the MG3 Kit						MG2-QTB 991011	1SNB991011R0000		1	120.00
-------------------------	--	--	--	--	--	----------------	-----------------	--	---	--------

MG-CPM-04

Individual markers

8	0.315	5 x 10	0.197 x 0.394	32	White <input type="checkbox"/>	MG-CPM-04 41390	1SNB041390R0510	41	1680	0.30
					Yellow <input type="checkbox"/>	MG-CPM-04 41340	1SNB041340R0510	41	1680	0.40

Strip markers

6	0.236	6 x 10	0.236 x 0.394	48	White <input type="checkbox"/>	MG-CPM-04 41391	1SNB041391R0610	45	1344	0.20
5.2	0.205	5 x 10	0.197 x 0.394		White <input type="checkbox"/>	MG-CPM-04 41395	1SNB041395R0510	31	1680	0.30

Support plate

Included in the MG3 Kit						MG2-QTB 991011	1SNB991011R0000		1	120.00
-------------------------	--	--	--	--	--	----------------	-----------------	--	---	--------

MG-CPM-05

Individual markers

5	0.197	5 x 10	0.197 x 0.394	56	White <input type="checkbox"/>	MG-CPM-05 41490	1SNB041490R0510	51	1960	0.40
---	-------	--------	---------------	----	--------------------------------	-----------------	-----------------	----	------	------

Strip markers

5	0.197	5 x 10	0.197 x 0.394	56	White <input type="checkbox"/>	MG-CPM-05 41494	1SNB041494R0510	51	1960	0.20
---	-------	--------	---------------	----	--------------------------------	-----------------	-----------------	----	------	------

Support plate

Purchased separately						MG2-WTB 991004	1SNB991004R0000		1	151.00
----------------------	--	--	--	--	--	----------------	-----------------	--	---	--------

MG-CPM-06

Individual markers

6	0.236	5 x 10	0.197 x 0.394	44	White <input type="checkbox"/>	MG-CPM-06 41591	1SNB041591R0510	61	1540	0.20
---	-------	--------	---------------	----	--------------------------------	-----------------	-----------------	----	------	------

Support plate

Purchased separately						MG2-STB 991005	1SNB991005R0000		1	158.00
----------------------	--	--	--	--	--	----------------	-----------------	--	---	--------

See other manufacturers selection guide at the end of this catalogue

Continue on next page →



MG-CPM terminal block markers

Blank markers for other manufacturers

Ordering details

Spacing		Dimensions		Nb. of markers per card	Color	Type	Part Number	SW code	Pkg marker	Weight 1 marker
mm	in	mm	in							

← Continuation of previous page

MG-CPM-07

Individual markers

5.2	0.205	5 x 10	0.197 x 0.394	48	White	MG-CPM-07 41691	1SNB041691R0510	71	1680	0.30
-----	-------	--------	---------------	----	-------	-----------------	-----------------	----	------	------

Support plate

Included in the MG3 Kit						MG2-QTB 991011	1SNB991011R0000		1	120.00
-------------------------	--	--	--	--	--	----------------	-----------------	--	---	--------

MG-CPM-09

Flexible pitch strip markers

5 ... 6	0.197 ... 0.236	5 x 10	0.197 x 0.394	56	White	MG-CPM-09 41890	1SNB041890R0510	92	1960	0.20
---------	-----------------	--------	---------------	----	-------	-----------------	-----------------	----	------	------

Support plate

Purchased separately						MG2-LTB 991013	1SNB991013R0000		1	128.00
----------------------	--	--	--	--	--	----------------	-----------------	--	---	--------

MG-CPM-10

Individual markers

5.5	0.217	5 x 12	0.197 x 0.472	48	White	MG-CPM-10 46192	1SNB046192R0512	101	1680	0.30
-----	-------	--------	---------------	----	-------	-----------------	-----------------	-----	------	------

Support plate

Purchased separately						MG2-CTB 991006	1SNB991006R0000		1	156.00
----------------------	--	--	--	--	--	----------------	-----------------	--	---	--------

MG-CPM-12

Flexible pitch strip markers

5 ... 6	0.197 ... 0.236	4.2 x 9	0.165 x 0.354	56	White	MG-CPM-12 46390	1SNB046390R4209	112	1960	0.20
		4.2 x 6	0.165 x 0.236		White	MG-CPM-12 46391	1SNB046391R4206	111	1960	0.20

Support plate

Purchased separately						MG2-WTB 991004	1SNB991004R0000		1	151.00
----------------------	--	--	--	--	--	----------------	-----------------	--	---	--------

See other manufacturers selection guide at the end of this catalogue

Mounting instruction

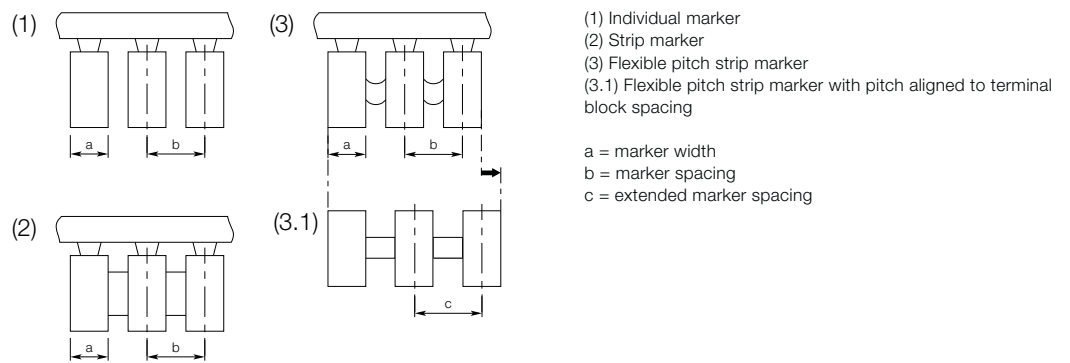

3

1SNB160167S0201

RC810TT end stop markers

Blank markers for BAM2, BADL, BADH



1SNC160246R0014

RC810TT

Description

- Blank marker card designed for high marking quality,
- Excellent marking durability in the most severe environments,
- Made of rigid polycarbonate.

Main technical data

Material	Flammability	Temperature range
Polycarbonate	V0	-50°C to +120°C -58°F to +248°F

Ordering details

Dimensions		Maximum printed digits		Nb. of markers per card	Color	Type	Part Number	SW code	Pkg card	Weight (1 card) g
mm	in	Hor.	Vert.							

SNA and Solution series markers



RC810TT

Dimensions	Maximum printed digits	Nb. of markers per card	Color	Type	Part Number	SW code	Pkg	Weight	
10 x 8	0.394 x 0.315	4	7	30	White <input type="checkbox"/> RC810TT	1SNA234600R1000	138	22	12.00
					Yellow <input type="checkbox"/> RC810TT-YL	1SNA234700R1400	138	22	12.00

Marking system accessories

MG2-ABM

Support plate

Support template for terminal block markers RCTT and MC series	MG2-ABM 991012	1SNB991012R0000		1	146.00
--	----------------	-----------------	--	---	--------



Compatible end stops



BAM2
1SNA206351R1600



BADL
1SNA399903R0200



BADH
1SNA116900R2700



BAMH
1SNA114836R0000



LH, LH-R1 end stop label holders

For MG-TAA and MG-TAR labels



1SNK160210R0014

Description

- Easily identify your terminal blocks assembly with white or yellow labels,
- Adjustable in height for best visibility,
- Compatible with all SNK end stops.

Main technical data

Material	Flammability	Temperature range
Polyamide	V0	-55°C to +110°C -67°F to +230°F

Ordering details

Spacing		Dimensions		Color	Type	Part Number	SW code	Pkg	Weight
mm	in	mm	in					pce	(1 pce) g

For MG-TAA 49498 and MG-TAA 49448

LH

10	0.394	8.8 x 30	0.35 x 1.18	Dark Grey	LH	1SNK900605R0000		50	0.60
----	-------	----------	-------------	-----------	----	-----------------	--	----	------

For MG-TAA 49198, MG-TAA 49148 and MG-TAR 45194

LH-R1

19.5	0.768	17.9 x 35.65	0.70 x 1.40	Dark Grey	LH-R1	1SNK900607R0000		50	1.10
------	-------	--------------	-------------	-----------	-------	-----------------	--	----	------

Dimensions given apply to the labelling area.



LH



LH-R1

Compatible end stops



BAM4
1SNK900001R0000



BAZ1
1SNK900002R0000



BAZH1
1SNK900102R0000

1SNK160180S0201

PEB end stop label holders

For MG-TAA and MG-TAR labels

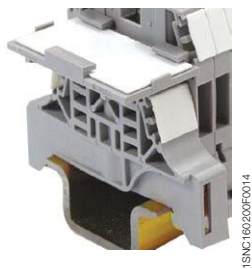

PEB

1SNC160200F0014

Description

- To be used for terminal block assembly identification,
- Direct insertion onto end stops from SNA series.

Main technical data

Material	Flammability	Temperature range
Polyamide (PEB)	V0	-55°C to +110°C -67°F to +230°F
PVC (EPR1)		

Ordering details

Dimensions	Color	Type	Part Number	Pkg	Weight
mm				pce	(1 pce) g

PEB

Label holder for end stop 35 x 17 mm 1.378 x .669 in, to be snapped onto end stop

18 x 35.5	0.709 x 1.378	Grey <input type="checkbox"/> PEB	1SNA113077R1100	50	1.70
-----------	---------------	-----------------------------------	-----------------	----	------

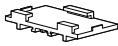

EPR1

Card of 54 PVC protective covers

17.5 x 35	0.689 x 1.378	Transparent <input checked="" type="checkbox"/> EPR1	1SNA178431R2200	1	0.054
-----------	---------------	--	-----------------	---	-------





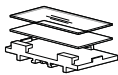

PEBM

"All in one": PEB marker holder with marker and protection included

		PEBM	1SNA113084R0100	50	2.80
--	--	------	-----------------	----	------



Compatible end stops

					
BAM2 1SNA206351R1600	BADL 1SNA399903R0200	BADH 1SNA116900R2700	BAMH 1SNA114836R0000	BAR 1SNA164519R2400	BADRL 1SNA199420R2100

1SNC160186S0201 - Rev. A



PEAD end stop label holders

For MG-TAPW49096 label



1SNC160068F0014

PEAD

Description

- Easily identify your terminal block assemblies with white or yellow labels,
- Adjustable in height for best visibility,
- Compatible with MG-TAPW 49096 and 49046,
- Compatible with BAM2 and BADL SNA series end stops.

Main technical data

Material	Flammability
Polyamide	V0

Ordering details

Dimensions	Color	Type	Part Number	Pkg	Weight
mm				pce	(1 pce) g

PEAD

Label holder for end stop, compatible with MG-TAPW49096 markers and EPR2 cover.

9 x 29	0.354 x 1.142	Grey <input type="checkbox"/> PEAD	1SNA399719R1000	20	0.78
--------	---------------	------------------------------------	-----------------	----	------

EPR2

Card of 20 covers compatible with MG-TAPW 49096 and 49046.

9 x 29	0.354 x 1.142	Transparent <input checked="" type="checkbox"/> EPR2	1SNA399726R0700	1	4.00
--------	---------------	--	-----------------	---	------

Dimensions given apply to the labelling area.

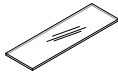

Compatible end stops



BAM2
1SNA206351R1600



BADL
1SNA399903R0200

3

1SNC160189S0201 - Rev. A

MG3 wire and cable markers

Selection guide

Fast and direct wire and cable identification

Save time on your cable identification job by using direct insertion cable markers MG-TDM, MG-TDMO or MG-ETF. Directly print the marker and attached it to the cable of your choice.



MG-TDM
Slide-on cable marker



MG-TDMO
Clip-on cable marker



MG-ETF
Tie-on cable marker

Evolute and protected wire and cable identification

Each individual label and label holder is easily detached from the stem for installation onto cable. The printed label in its holder is perfectly protected over time.



MG-TPMF
Easy entry thanks to profiled shape



MG-TPM
For more efficiency, stems can be cable tied together using the holes provided

For fast and easy cable identification

Markers directly mounted on wires and cables

Wire external diameter		Conductor section mm ²	Marker length		Marker color	Slide-on cable marker MG-TDM	Clip-on cable marker MG2-TDMO
mm	in		mm	in			
Ø 1.6 ... 3.25	Ø 0.06 ... 0.12	0.5 ... 1.5	12	0.472	White <input type="checkbox"/>	MG-TDM-01 49190	–
					Yellow <input checked="" type="checkbox"/>	MG-TDM-01 40140	–
			16	0.630	White <input type="checkbox"/>	MG-TDM-01 49191	–
					Yellow <input checked="" type="checkbox"/>	MG-TDM-01 40141	–
Ø 2 ... 2.9	Ø 0.07 ... 0.11	0.5 ... 1.5	12	0.472	White <input type="checkbox"/>	–	MG2-TDMO-01 40390
					Yellow <input checked="" type="checkbox"/>	–	MG2-TDMO-01 40340
			16	0.630	White <input type="checkbox"/>	–	MG2-TDMO-01 40391
					Yellow <input checked="" type="checkbox"/>	–	MG2-TDMO-01 40341
Ø 2.9 ... 3.5	Ø 0.11 ... 0.14	1.5 ... 2.5	12	0.472	White <input type="checkbox"/>	–	MG2-TDMO-02 40490
					Yellow <input checked="" type="checkbox"/>	–	MG2-TDMO-02 40440
			16	0.630	White <input type="checkbox"/>	–	MG2-TDMO-02 40491
					Yellow <input checked="" type="checkbox"/>	–	MG2-TDMO-02 40441
Ø 2 ... 4.4	Ø 0.07 ... 0.17	1 ... 6	12	0.472	White <input type="checkbox"/>	MG-TDM-02 40290	–
					Yellow <input checked="" type="checkbox"/>	MG-TDM-02 40240	–
			16	0.630	White <input type="checkbox"/>	MG-TDM-02 40291	–
					Yellow <input checked="" type="checkbox"/>	MG-TDM-02 40241	–
Ø 4 ... 4.6	Ø 0.16 ... 0.18	4 ... 6	12	0.472	White <input type="checkbox"/>	–	MG2-TDMO-03 40590
					Yellow <input checked="" type="checkbox"/>	–	MG2-TDMO-03 40540
			16	0.630	White <input type="checkbox"/>	–	MG2-TDMO-03 40591
					Yellow <input checked="" type="checkbox"/>	–	MG2-TDMO-03 40541

15NC160214S0201

For evolutive identification

Marker holders + slide-in markers

Wire external diameter		Conductor section mm ²	Label holder length		PM	Compatible labels	PMF	Compatible labels
mm	in		mm	in				
Ø 1.3 ... 2.2	Ø 0.051 ... 0.087	0.25 ... 0.5	10	0.394	-	-	PMF-00 90000	MG-TPMF 42090B
			12	0.472	-	-	PMF-00 90020	MG-TPMF 42091B
			15	0.591	-	-	PMF-00 90010	MG-TPMF 42092B
Ø 2 ... 3.7	Ø 0.079 ... 0.146	0.5 ... 2.5	10	0.394	PM-01 50100	MG-TPM 40090	PMF-01 90100	MG-TPMF 42090B
			12	0.472	PM-01 50110	MG-TPM 40091	PMF-01 90110	MG-TPMF 42091B
			15	0.591	PM-01 50120	MG-TPM 40092	PMF-01 90120	MG-TPMF 42092B
Ø 3.5 ... 4.3	Ø 0.138 ... 0.169	2.5 ... 4	10	0.394	PM-02 50200	MG-TPM 40090	PMF-02 90200	MG-TPMF 42090B
			12	0.472	PM-02 50210	MG-TPM 40091	PMF-02 90210	MG-TPMF 42091B
			15	0.591	PM-02 50220	MG-TPM 40092	PMF-02 90220	MG-TPMF 42092B
Ø 4 ... 6.3	Ø 0.157 ... 0.248	4 ... 10	10	0.394	PM-03 50300	MG-TPM 40090	PMF-03 90300	MG-TPMF 42090B
			12	0.472	PM-03 50310	MG-TPM 40091	PMF-03 90310	MG-TPMF 42091B
			15	0.591	PM-03 50320	MG-TPM 40092	PMF-03 90320	MG-TPMF 42092B
Ø 6 ... 10	Ø 0.236 ... 0.394	10 ... 25	10	0.394	PM-04 50400	MG-TPM 40090	PMF-04 90400	MG-TPMF 42090B
			12	0.472	PM-04 50410	MG-TPM 40091	PMF-04 90410	MG-TPMF 42091B
			15	0.591	PM-04 50420	MG-TPM 40092	PMF-04 90420	MG-TPMF 42092B
Ø 9 ... 15	Ø 0.354 ... 0.591	25 ... 70	10	0.394	PM-05 50500	MG-TPM 40090	PMF-05 90500	MG-TPMF 42090B
			12	0.472	PM-05 50510	MG-TPM 40091	PMF-05 90510	MG-TPMF 42091B
			15	0.591	PM-05 50521	MG-TPM 40092	PMF-05 90520	MG-TPMF 42092B
Ø 14 ... 26	Ø 0.551 ... 1.024	70 ... 240	10	0.394	PM-06 50600	MG-TPM 40090	-	-
			12	0.472	PM-06 50610	MG-TPM 40091	-	-
			15	0.591	PM-06 50620	MG-TPM 40092	-	-

Label holders are given for biggest packaging. For smaller packaging see product page. Compatible labels are given in White color, see product page for more colors.

For identification of thick tubes

Tie-on markers / label holders

Marker / Marker holder length		Marker color	Marker holder color	MG-ETF	PM-ET	Compatible marker	PMF-ET	Compatible marker
mm	in							
13 x 57	0.512 x 2.244	White <input type="checkbox"/>	-	MG-ETF 54192	-	-	-	-
		Yellow <input type="checkbox"/>	-	MG-ETF 54142	-	-	-	-
12	0.472	White <input type="checkbox"/>	Transparent <input checked="" type="checkbox"/>	-	PM-ET 53010	MG-TPM 40091	-	-
15	0.591	White <input type="checkbox"/>	Transparent <input checked="" type="checkbox"/>	-	PM-ET 53020	MG-TPM 40092	PMF-ET 63020	MG-TPMF 42092B

MG-TDM wire and cable markers

Slide-on cable blank markers

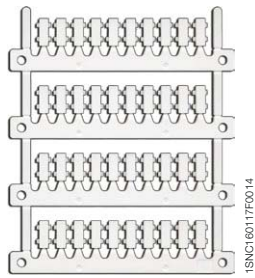

MG-TDM-01

Description

- To be directly printed and slid onto the wire,
- Partially printed marker cards may be re-used to avoid wastage,
- Made of rigid polycarbonate.

Main technical data

Material	Flammability	Temperature range
Polycarbonate	V0	-40°C to +140°C -40°F to +284°F

Ordering details

Dimensions	Nb. of markers per card	Color	Type	Part Number	SW code	Pkg	Weight
mm in						marker (1 marker)	g

Cable Ø 1.6-3.25 mm 0.06-0.12 in Section 0.5-1.5 mm²

MG-TDM-01 Length 12 mm 0.472 in

4 x 12	0.157 x 0.472	66	White <input type="checkbox"/>	MG-TDM-01 40190	1SNB040190R0412	121	1320	0.30
			Yellow <input type="checkbox"/>	MG-TDM-01 40140	1SNB040140R0412	121	1320	0.30

Support plate

Purchased separately				MG2-PTD 991007	1SNB991007R0000		1	126.00
----------------------	--	--	--	----------------	-----------------	--	---	--------

MG-TDM-01 Length 16 mm 0.630 in

4 x 16	0.157 x 0.630	40	White <input type="checkbox"/>	MG-TDM-01 40191	1SNB040191R0416	123	800	0.30
			Yellow <input type="checkbox"/>	MG-TDM-01 40141	1SNB040141R0416	123	800	0.30

Support plate

Purchased separately				MG2-PTM 991010	1SNB991010R0000		1	116.00
----------------------	--	--	--	----------------	-----------------	--	---	--------

Cable Ø 2-4.4 mm 0.07-0.17 in Section 1-6 mm²

MG-TDM-02 Length 12 mm 0.472 in

4 x 12	0.157 x 0.472	66	White <input type="checkbox"/>	MG-TDM-02 40290	1SNB040290R0412	122	1056	0.30
			Yellow <input type="checkbox"/>	MG-TDM-02 40240	1SNB040240R0412	122	1056	0.30

Support plate

Purchased separately				MG2-PTD 991007	1SNB991007R0000		1	126.00
----------------------	--	--	--	----------------	-----------------	--	---	--------

MG-TDM-02 Length 16 mm 0.630 in

4 x 16	0.157 x 0.630	40	White <input type="checkbox"/>	MG-TDM-02 40291	1SNB040291R0416	124	640	0.40
			Yellow <input type="checkbox"/>	MG-TDM-02 40241	1SNB040241R0416	124	640	0.40

Support plate

Purchased separately				MG2-PTM 991010	1SNB991010R0000		1	116.00
----------------------	--	--	--	----------------	-----------------	--	---	--------

Mounting instruction





MG2-TDMO wire and cable markers

Clip-on cable blank markers

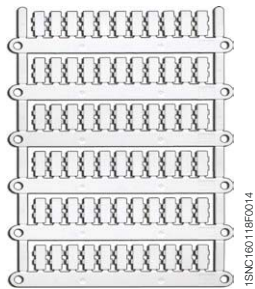

MG2-TDMO-01

Description

- To be directly printed and clip onto the wire,
- Partially printed marker cards may be re-used to avoid wastage,
- Made of rigid polycarbonate.

Main technical data

Material	Flammability	Temperature range
Polycarbonate	V0	-40°C to +140°C -40°F to +284°F

Ordering details

Dimensions	Nb. of markers per card	Color	Type	Part Number	SW code	Pkg	Weight
mm in						marker	1 marker g

Cable Ø 2-2.9 mm 0.07-0.11 in Section 0.5-1.5 mm²

MG2-TDMO-01

4 x 12	0.157 x 0.472	40	White □	MG2-TDMO-01 40390	1SNB040390R0412	125	880	0.30
			Yellow ■	MG2-TDMO-01 40340	1SNB040340R0412	125	800	0.30
4 x 16	0.157 x 0.630		White □	MG2-TDMO-01 40391	1SNB040391R0416	128	880	0.30
			Yellow ■	MG2-TDMO-01 40341	1SNB040341R0416	128	800	0.30

Cable Ø 2.9-3.5 mm 0.11-0.14 in Section 1.5-2.5 mm²

MG2-TDMO-02

4 x 12	0.157 x 0.472	40	White □	MG2-TDMO-02 40490	1SNB040490R0412	126	640	0.40
			Yellow ■	MG2-TDMO-02 40440	1SNB040440R0412	126	640	0.40
4 x 16	0.157 x 0.630		White □	MG2-TDMO-02 40491	1SNB040491R0416	129	640	0.40
			Yellow ■	MG2-TDMO-02 40441	1SNB040441R0416	129	640	0.40

Cable Ø 4-4.6 mm 0.16-0.18 in Section 4-6 mm²

MG2-TDMO-03

4 x 12	0.157 x 0.472	40	White □	MG2-TDMO-03 40590	1SNB040590R0412	127	560	0.40
			Yellow ■	MG2-TDMO-03 40540	1SNB040540R0412	127	560	0.40
4 x 16	0.157 x 0.630		White □	MG2-TDMO-03 40591	1SNB040591R0416	130	560	0.40
			Yellow ■	MG2-TDMO-03 40541	1SNB040541R0416	130	560	0.40

Marking system accessories

MG2-PTM

Support plate

Purchased separately		MG2-PTM 991010	1SNB991010R0000		1	116.00
----------------------	--	----------------	-----------------	--	---	--------



Mounting instruction

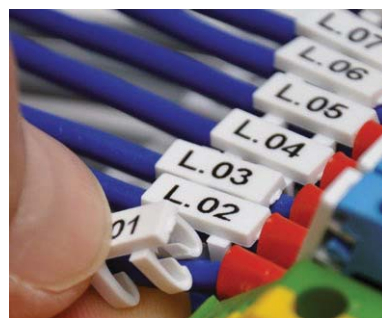

Compatible holders



UMH

UMH wire and cable marker holders

Universal wire marker holders



1SNK190061R0000

UMH

Description

- Compatible with most of the wire markers available on the market (wire markers not supplied with UMH),
- Quickly fit to any SNK terminal blocks and accessories: strip mounting of 10 parts for 5.2 mm 0.205 in spacing, unitary mounting for other spacings

Main technical data

Material	Flammability	Temperature range
Polyamide	V0	-55°C to +110°C -67°F to +230°F

Ordering details

Dimensions		Nb. of markers per card	Color	Type	Part Number	Pkg	Weight
mm	in						
14.5 x 6	0.571 x 0.236	10	Grey	<input type="checkbox"/> UMH	1SNK900611R0000	10	0.20

Mounting instruction



Install the UMH on the terminal blocks (strip mounting) and slide on the wire markers.

1SNK190186S0201



MG-ETF wire and cable markers

Tie-on cable precut blank labels

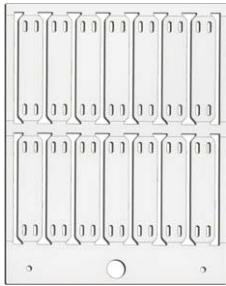

1SNB054192R1357

MG-ETF

Description

- Recommended for marking large diameter cables, hoses, tubes and conduits,
- To be used with cable ties (max. width 4.8 mm 0.19 in),
- Print area 15 x 20 mm 0.59 x 0.79 in,
- Made of rigid PVC.

Main technical data

Material	Flammability	Temperature range
Rigid PVC	V0	-30°C to +80°C -22°F to +176°F

Ordering details

Dimensions		Nb. of markers per card	Color	Type	Part Number	SW code	Pkg	Weight
mm	in							
13 x 57	0.512 x 2.244	14	White <input type="checkbox"/>	MG-ETF 54192	1SNB054192R1357	581	700	0.70
			Yellow <input type="checkbox"/>	MG-ETF 54142	1SNB054142R1357	581	700	0.70

Marking system accessories

MG2-PLT

Support plate

Included in the MG3 Kit		MG2-PLT 991002	1SNB991002R0000		1	148.50
-------------------------	--	----------------	-----------------	--	---	--------



Mounting instruction





MG-TPM wire and cable markers

Slide-in precut blank labels

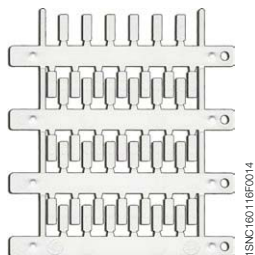

1SNB00116P0014

MG-TPM

Description

- To be slid into PM holder,
- For cable up to 240 mm²,
- PM holders can be directly inserted on the markers without removing them from the stems,
- Made of rigid ABS.

Main technical data

Material	Flammability	Temperature range
Acrylonitrile Butadienne Styrene (ABS)	V0	-30°C to +80°C -22°F to +176°F

Ordering details

Dimensions		Nb. of markers per card	Color	Type	Part Number	SW code	Pkg	Weight
mm	in							
MG-TPM								
4 x 10	0.157 x 0.394	45	White	MG-TPM 40090	1SNB040090R0410	1	2250	0.30
4 x 12	0.157 x 0.472		White	MG-TPM 40091	1SNB040091R0412	2	2250	0.30
4 x 15	0.157 x 0.591		White	MG-TPM 40092	1SNB040092R0415	3	2250	

14B3V1

Marking system accessories

MG2-PWC

Support plate

Included in the MG3 Kit		MG2-PWC 991000	1SNB991000R0000		1	148.50
-------------------------	--	----------------	-----------------	--	---	--------



Compatible holders



PM



PM-ET



PM-AC

1SNB00171S0201



PM, PM-ET and PM-AC transparent marker holders

For MG-TPM markers



1SN0160251F0014

PM

Description

- Compatible with MG-TPM markers,
- Made of plasticised PVC.

Main technical data

Material	Flammability	Temperature range
PVC	V0	-40°C to +90°C -40°F to +194°F

Ordering details

Wire ext. diameter	Wire section	Holder length	Color	Type	Part Number	Pkg	Weight
mm	mm ²	mm				pce	(1 pce) g

For cable mounting

PM



PM-01

Profiled transparent holder to allow each type to accommodate a range of cable sizes

2 ... 3.7	0.079 ... 0.146	0.5 ... 2.5	10	0.394	Transparent	<input checked="" type="checkbox"/>	PM-01 50100	1SNB050100R0000	6000	0.20
					Transparent	<input checked="" type="checkbox"/>	PM-01 50102	1SNB050102R0001	2000	0.20
					Transparent	<input checked="" type="checkbox"/>	PM-01 50102-HF	1SNB050102R0002	2000	0.10
3.5 ... 4.3	0.138 ... 0.169	2.5 ... 4	10	0.394	Transparent	<input checked="" type="checkbox"/>	PM-01 50110	1SNB050110R0000	5000	0.20
					Transparent	<input checked="" type="checkbox"/>	PM-01 50120	1SNB050120R0000	4000	0.20
					Transparent	<input checked="" type="checkbox"/>	PM-01 50122	1SNB050122R0000	1000	0.20
				0.472	Transparent	<input checked="" type="checkbox"/>	PM-02 50200	1SNB050200R0000	4000	0.30
					Transparent	<input checked="" type="checkbox"/>	PM-02 50202	1SNB050202R0000	1000	0.30
					Transparent	<input checked="" type="checkbox"/>	PM-02 50210	1SNB050210R0000	4000	0.30
4 ... 6.3	0.157 ... 0.248	4 ... 10	10	0.394	Transparent	<input checked="" type="checkbox"/>	PM-02 50212	1SNB050212R0000	1000	0.30
					Transparent	<input checked="" type="checkbox"/>	PM-02 50220	1SNB050220R0000	3000	0.35
					Transparent	<input checked="" type="checkbox"/>	PM-02 50222	1SNB050222R0000	1000	0.35
				0.472	Transparent	<input checked="" type="checkbox"/>	PM-02 50222	1SNB050222R0000	1000	0.35
					Transparent	<input checked="" type="checkbox"/>	PM-03 50300	1SNB050300R0000	3000	0.30
					Transparent	<input checked="" type="checkbox"/>	PM-03 50302	1SNB050302R0000	1000	0.30
				0.591	Transparent	<input checked="" type="checkbox"/>	PM-03 50310	1SNB050310R0000	2000	0.40
					Transparent	<input checked="" type="checkbox"/>	PM-03 50312	1SNB050312R0000	500	0.40
					Transparent	<input checked="" type="checkbox"/>	PM-03 50320	1SNB050320R0000	2000	0.45
6 ... 10	0.236 ... 0.394	10 ... 25	10	0.394	Transparent	<input checked="" type="checkbox"/>	PM-03 50322	1SNB050322R0000	500	0.45
					Transparent	<input checked="" type="checkbox"/>	PM-04 50400	1SNB050400R0000	2000	0.45
					Transparent	<input checked="" type="checkbox"/>	PM-04 50402	1SNB050402R0000	500	0.45
				0.472	Transparent	<input checked="" type="checkbox"/>	PM-04 50410	1SNB050410R0000	1000	0.50
					Transparent	<input checked="" type="checkbox"/>	PM-04 50411	1SNB050411R0000	500	0.50
					Transparent	<input checked="" type="checkbox"/>	PM-04 50420	1SNB050420R0000	1000	0.60
9 ... 15	0.354 ... 0.591	25 ... 70	10	0.394	Transparent	<input checked="" type="checkbox"/>	PM-04 50421	1SNB050421R0000	500	0.60
				0.472	Transparent	<input checked="" type="checkbox"/>	PM-05 50500	1SNB050500R0000	500	0.70
					Transparent	<input checked="" type="checkbox"/>	PM-05 50510	1SNB050510R0000	500	0.80
14 ... 26	0.551 ... 1.024	70 ... 240	10	0.591	Transparent	<input checked="" type="checkbox"/>	PM-05 50521	1SNB050521R0000	250	1.10
				0.394	Transparent	<input checked="" type="checkbox"/>	PM-06 50600	1SNB050600R0000	500	1.30
				0.472	Transparent	<input checked="" type="checkbox"/>	PM-06 50610	1SNB050610R0000	250	1.40
				0.591	Transparent	<input checked="" type="checkbox"/>	PM-06 50620	1SNB050620R0000	250	2.70

PM-ET



PM-ET

Tie-on transparent holder for longitudinal mounting on cables, hoses, tubes and conduit (tie width max 6 mm 0.236 in)

			12	0.472	Transparent	<input checked="" type="checkbox"/>	PM-ET 53010	1SNB053010R0000	2000	0.40
			15	0.591	Transparent	<input checked="" type="checkbox"/>	PM-ET 53020	1SNB053020R0000	2000	0.50

For surface mounting

PM-AC



PM-AC

Self-adhesive transparent holder to be used over all plane surfaces

			10	0.394	Transparent	<input checked="" type="checkbox"/>	PM-AC 51000N	1SNB051000R0000	5000	0.20
			12	0.472	Transparent	<input checked="" type="checkbox"/>	PM-AC 51010N	1SNB051010R0000	4000	0.20
			15	0.591	Transparent	<input checked="" type="checkbox"/>	PM-AC 51020N	1SNB051020R0000	4000	0.30

Use holders only with designated cable marker of the same or a shorter length.

3

1SN0160172S0201 - Rev. A



MG-TPMF wire and cable markers

Slide-in precut blank labels



1SNB042090R0410

MG-TPMF

Description

- To be slid into PMF holder,
- For wire and cable up to 70 mm²,
- Made of rigid PVC.

Main technical data

Material	Flammability	Temperature range
Rigid PVC	V0	-30°C to +80°C -22°F to +176°F

Ordering details

Dimensions	Nb. of markers per card	Color	Type	Part Number	SW code	Pkg	Weight
mm in						marker (1 marker)	g
MG-TPMF							
4 x 10	0.157 x 0.394	112	White <input type="checkbox"/>	MG-TPMF 42090B	1SNB042090R0410	502	5600 0.10
4 x 12	0.157 x 0.472	80	White <input type="checkbox"/>	MG-TPMF 42091B	1SNB042091R0412	505	4000 0.10
4 x 15	0.157 x 0.591		White <input type="checkbox"/>	MG-TPMF 42092B	1SNB042092R0415	503	4000 0.10

13021-1

Marking system accessories

MG2-PLT

Support plate

Included in the MG3 Kit		MG2-PLT 991002	1SNB991002R0000			1	148.50
-------------------------	--	----------------	-----------------	--	--	---	--------



Compatible holders



PMF



PMF-ET



PMF-AC

1SNB042090R0410



PMF, PMF-ET and PMF-AC transparent marker holders

For MG-TPMF markers



PMF-00

1SNC160251F0014

Description

- Compatible with MG-TPMF markers,
- Made of plasticised PVC.

Main technical data

Material	Flammability	Temperature range
PVC	V0	-40°C to +90°C -40°F to +194°F

Ordering details

Wire ext. diameter	Wire section	Holder length	Color	Type	Part Number	Pkg	Weight
mm : in	mm ²	mm : in				pce	(1 pce) g

For cable mounting

PMF



Profiled transparent holder to allow each type to accommodate a range of cable sizes

1.3 ... 2.2	0.051 ... 0.087	0.25 ... 0.5	10	0.394	Transparent	<input checked="" type="checkbox"/>	PMF-00 90000	1SNB090000R0000	8000	0.10
			12	0.472	Transparent	<input checked="" type="checkbox"/>	PMF-00 90010	1SNB090010R0000	7000	0.10
			15	0.591	Transparent	<input checked="" type="checkbox"/>	PMF-00 90020	1SNB090020R0000	6000	0.10
2 ... 3.7	0.079 ... 0.146	0.5 ... 2.5	10	0.394	Transparent	<input checked="" type="checkbox"/>	PMF-01 90100	1SNB090100R0000	6000	0.20
			12	0.472	Transparent	<input checked="" type="checkbox"/>	PMF-01 90110	1SNB090110R0000	5000	0.20
			15	0.591	Transparent	<input checked="" type="checkbox"/>	PMF-01 90120	1SNB090120R0000	4000	0.20
3.4 ... 4.3	0.134 ... 0.169	2.5 ... 4	10	0.394	Transparent	<input checked="" type="checkbox"/>	PMF-02 90200	1SNB090200R0000	4000	0.20
			12	0.472	Transparent	<input checked="" type="checkbox"/>	PMF-02 90210	1SNB090210R0000	4000	0.30
			15	0.591	Transparent	<input checked="" type="checkbox"/>	PMF-02 90220	1SNB090220R0000	3000	0.30
4 ... 6.3	0.157 ... 0.248	4 ... 10	10	0.394	Transparent	<input checked="" type="checkbox"/>	PMF-03 90300	1SNB090300R0000	3000	0.40
			12	0.472	Transparent	<input checked="" type="checkbox"/>	PMF-03 90310	1SNB090310R0000	2000	0.40
			15	0.591	Transparent	<input checked="" type="checkbox"/>	PMF-03 90320	1SNB090320R0000	2000	0.50
6 ... 10	0.236 ... 0.394	10 ... 25	10	0.394	Transparent	<input checked="" type="checkbox"/>	PMF-04 90400	1SNB090400R0000	2000	0.40
			12	0.472	Transparent	<input checked="" type="checkbox"/>	PMF-04 90410	1SNB090410R0000	1000	0.60
			15	0.591	Transparent	<input checked="" type="checkbox"/>	PMF-04 90420	1SNB090420R0000	1000	0.70
			10	0.394	Transparent	<input checked="" type="checkbox"/>	PMF-05 90500	1SNB090500R0000	500	0.90
			12	0.472	Transparent	<input checked="" type="checkbox"/>	PMF-05 90510	1SNB090510R0000	500	1.10
9 ... 15	0.354 ... 0.591	25 ... 70	15	0.591	Transparent	<input checked="" type="checkbox"/>	PMF-05 90520	1SNB090520R0000	250	1.40

PMF-ET



Tie-on transparent holder for longitudinal mounting on cables, hoses, tubes and conduit (tie width max 6 mm 0.236 in)

			15	0.591	Transparent	<input checked="" type="checkbox"/>	PMF-ET 63020	1SNB063020R0000	2000	0.40
--	--	--	----	-------	-------------	-------------------------------------	--------------	-----------------	------	------

For surface mounting

PMF-AC



Self-adhesive transparent holder to be used over all plane surfaces

			10	0.394	Transparent	<input checked="" type="checkbox"/>	PMF-AC 66000N	1SNB066000R0000	5000	0.20
			12	0.472	Transparent	<input checked="" type="checkbox"/>	PMF-AC 66010N	1SNB066010R0000	4000	0.20
			15	0.591	Transparent	<input checked="" type="checkbox"/>	PMF-AC 66020N	1SNB066020R0000	4000	0.30
			20	0.787	Transparent	<input checked="" type="checkbox"/>	PMF-AC 66040N	1SNB066040R0000	4000	0.30

Use holders only with designated cable marker of the same or a shorter length.

MG-TAA component and equipment markers

Self-adhesive precut blank labels

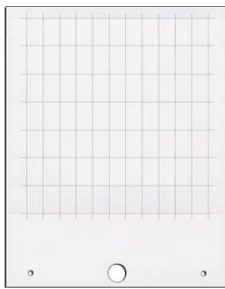

1SNC160199F0014

MG-TAA

Description

- To be used for external marking of components and equipment,
- Direct application on suitable surfaces (self-adhesive),
- Made of rigid PVC.

Main technical data

Material	Flammability	Temperature range
Rigid PVC	V0	-30°C to +80°C -22°F to +176°F

Ordering details

Dimensions		Nb. of markers per card	Color	Type	Part Number	SW code	Pkg marker	Weight (marker)
mm	in							
7 x 20	0.276 x 0.787	60	White	MG-TAA 49196	1SNB049196R0720	179	1500	0.30
8 x 17	0.315 x 0.669	72	White	MG-TAA 49493	1SNB049493R0817	194	1800	0.30
8.5 x 30	0.335 x 1.181	33	White	MG-TAA 49498	1SNB049498R8530	720	825	0.55
			Yellow	MG-TAA 49448	1SNB049448R8530	720	825	0.55
9 x 15	0.354 x 0.591	77	White	MG-TAA 49397N	1SNB049397R0915	961	1925	0.30
9 x 20	0.354 x 0.787	55	White	MG-TAA 49190N	1SNB049190N0920	962	1375	0.40
9 x 35	0.354 x 1.378	33	White	MG-TAA 49191N	1SNB049191R0935	964	825	0.60
15 x 27	0.591 x 1.063	28	White	MG-TAA 49193N	1SNB049193R1527	966	700	0.70
			Yellow	MG-TAA 49143N	1SNB049143R1527	966	700	0.70
15 x 44	0.591 x 1.732	12	White	MG-TAA 49298	1SNB049298R1544	854	300	1.20
15 x 49	0.591 x 1.929	14	White	MG-TAA 49194N	1SNB049194R1549	967	350	1.40
			Yellow	MG-TAA 49144N	1SNB049144R1549	967	350	1.50
15 x 67	0.591 x 2.638	7	White	MG-TAA 49195N	1SNB049195R1567	968	175	2.80
			Yellow	MG-TAA 49145N	1SNB049145R1567	968	175	2.80
17 x 35	0.669 x 1.378	18	White	MG-TAA 49198	1SNB049198R1735	711	450	0.91
			Yellow	MG-TAA 49148	1SNB049148R1735	711	450	0.91

Marking system accessories

MG2-PLT

Support plate

Included in the MG3 Kit	MG2-PLT 991002	1SNB991002R0000	1	148.50
-------------------------	----------------	-----------------	---	--------



Mounting instruction

AF09 contactor with MG-TAA 49196 marker



Compatible holders



LH
(only for MG-TAA 49498 and 49448)



LH-R1
(only for MG-TAA 49198 and 49148)



PEB
(only for MG-TAA 49198 and 49148)



MG-VYT component and equipment markers

Self-adhesive precut blank labels

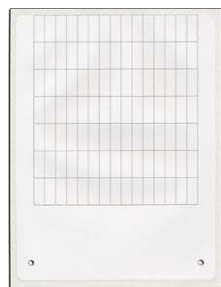

MG-VYT 46915

1SNC160140F0014

Description

- To be used for external or internal marking of components and equipment,
- Direct application on suitable surfaces (self-adhesive),
- Made of dielectric PVC film.

Main technical data

Material	Flammability	Temperature range
Dielectric PVC film	V0	-40°C to +80°C -40°F to +176°F

Ordering details

Dimensions		Nb. of markers per card	Color	Type	Part Number	SW code	Pkg marker	Weight (1 marker)
mm	in							
For internal marking								
6 x 15	0.236 x 0.591	105	White <input type="checkbox"/>	MG-VYT 46915	1SNB046915R0615	181	5250	0.10
			Yellow <input type="checkbox"/>	MG-VYT 46415	1SNB046415R0615	181	5250	
			Grey <input type="checkbox"/>	MG-VYT 46815	1SNB046815R0615	181	5250	
7 x 10	0.276 x 0.394	120	Grey <input type="checkbox"/>	MG-VYT 46891	1SNB046891R0710	191	6000	0.10
7 x 15	0.276 x 0.591	60	Grey <input type="checkbox"/>	MG-VYT 46828	1SNB046828R0715	182	3000	0.10
7 x 20	0.276 x 0.787		White <input type="checkbox"/>	MG-VYT 46935	1SNB046935R0720	179	3000	0.10
8 x 21	0.315 x 0.827		Grey <input type="checkbox"/>	MG-VYT 46824	1SNB046824R0821	196	3000	0.10
9 x 15	0.354 x 0.591	70	White <input type="checkbox"/>	MG-VYT 44895	1SNB044895R0915	161	3500	0.10
			Yellow <input type="checkbox"/>	MG-VYT 44845	1SNB044845R0915	161	3500	0.10
9 x 20	0.354 x 0.787	55	White <input type="checkbox"/>	MG-VYT 44896N	1SNB044896R0920	162	2750	0.10
			Grey <input type="checkbox"/>	MG-VYT 46896N	1SNB046896R0920	162	2750	0.10
9 x 35	0.354 x 1.378	33	White <input type="checkbox"/>	MG-VYT 46910N	1SNB046910R0935	164	1650	0.10
For external marking								
52 x 107	2.047 x 4.213	2	Grey <input type="checkbox"/>	MG-VYT 46811	1SNB046811R0052	204	100	2.40
For Allen Bradley internal marking								
5 x 12	0.197 x 0.472	120	White <input type="checkbox"/>	MG-VYT 46927	1SNB046927R0512	195	6000	
For Telemecanique								
8 x 17	0.315 x 0.669	72	Yellow <input type="checkbox"/>	MG-VYT 46423	1SNB046423R0817	194	3600	0.10
For Telemecanique internal marking								
8 x 17	0.315 x 0.669	72	White <input type="checkbox"/>	MG-VYT 46923	1SNB046923R0817	194	3600	0.10
			Grey <input type="checkbox"/>	MG-VYT 46823	1SNB046823R0817	194	3600	0.10

Marking system accessories

MG2-PLT

Support plate

Included in the MG3 Kit	MG2-PLT 991002	1SNB991002R0000	1	148.50
-------------------------	----------------	-----------------	---	--------



Mounting instruction

AF09 contactor with MG-VYT 46935 marker



1SNC160181S0201



MG-17.5A component and equipment markers

Self-adhesive precut blank labels



MG-17.5-A 990824

1SNC160265F0014

Description

- Used for marking modular components,
- Direct application on suitable surfaces (self-adhesive),
- Made of rigid PVC.

Main technical data

Material	Flammability	Temperature range
Rigid PVC	V0	-30°C to +80°C -22°F to +176°F

Ordering details

Dimensions		Nb. of markers per card	Color	Type	Part Number	SW code	Pkg	Weight
mm	in							
15 x 107.5	0.591 x 4.232	7	White <input type="checkbox"/>	MG-17.5-A 990824	1SNB990824R0015	929	175	2.80
			Yellow <input type="checkbox"/>	MG-17.5-A 990826	1SNB990826R0015	929	175	1.00

Marking system accessories

MG2-PLT

Support plate

Included in the MG3 Kit	MG2-PLT 991002	1SNB991002R0000	1	148.50
-------------------------	----------------	-----------------	---	--------



Mounting instruction

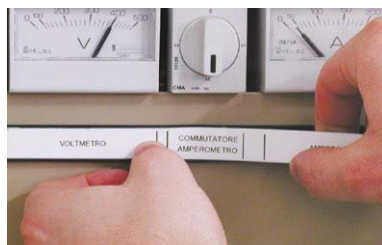



MG-PTS component and equipment markers

Precut blank labels

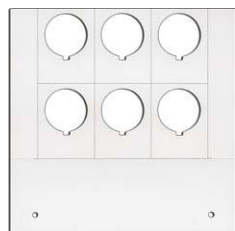

1SNB160136F0014

MG-PTS 15090

Description

- To be used for Ø 22.5 mm 0.886 in or Ø 31 mm 1.220 in push buttons identification,
- Direct application on suitable surfaces,
- Made of rigid PVC.

Main technical data

Material	Flammability	Temperature range
Rigid PVC	V0	-30°C to +80°C -22°F to +176°F

Ordering details

Dimensions		Nb. of markers per card	Color	Type	Part Number	SW code	Pkg	Weight
mm	in							
40 x 30	1.575 x 1.181	6	White □	MG-PTS 15090	1SNB015090R4030	1000	300	1.40

Marking system accessories

MG2-PLT

Support plate

Included in the MG3 Kit	MG2-PLT 991002	1SNB991002R0000	1	148.50
-------------------------	----------------	-----------------	---	--------



Mounting instruction



MG-TAP component and equipment markers

Precut blank labels

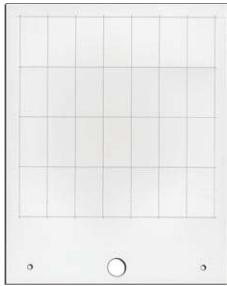

1SNB160194F0014

MG-TAP

Description

- Versatile precut label used to identify a wide range of devices : modular, component, push button, etc.,
- Can be used with legend rail RTA-TAP,
- Made of rigid PVC.

Main technical data

Material	Flammability	Temperature range
Rigid PVC	V0	-30°C to +80°C -22°F to +176°F

Ordering details

Dimensions	Nb. of markers per card	Color	Type	Part Number	SW code	Pkg	Weight
mm	in					marker	marker g

8.2 mm 0.323 in width

8.2 x 27	0.323 x 1.063	44	White <input type="checkbox"/>	MG-TAP 47096	1SNB047096R0827	807	2200	0.30
----------	---------------	----	--------------------------------	--------------	-----------------	-----	------	------

15 mm 0.591 in width

15 x 27	0.591 x 1.063	28	White <input type="checkbox"/>	MG-TAP 47091N	1SNB047091R1527	166	1400	0.40
			Yellow <input type="checkbox"/>	MG-TAP 47041N	1SNB047041R1527	166	1400	0.50
15 x 43	0.591 x 1.693	14	White <input type="checkbox"/>	MG-TAP 47198	1SNB047198R1543	353	700	0.10
15 x 49	0.591 x 1.929		White <input type="checkbox"/>	MG-TAP 47092N	1SNB047092R1549	167	700	0.90
15 x 67	0.591 x 2.638	7	White <input type="checkbox"/>	MG-TAP 47093N	1SNB047093R1567	168	350	1.80

18 mm 0.709 in width

18 x 27	0.709 x 1.063	20	White <input type="checkbox"/>	MG-TAP 47097	1SNB047097R1827	178	1000	0.60
			Yellow <input type="checkbox"/>	MG-TAP 47047	1SNB047047R1827	178	1000	0.60

Marking system accessories

MG2-PLT

Support plate

Included in the MG3 Kit	MG2-PLT 991002	1SNB991002R0000	1	148.50
-------------------------	----------------	-----------------	---	--------



Compatible holders



RTR-TAP 990454 and 990452
Pre-drilled rails (only for 15 mm 0.591 in MG-TAP)



RTA-TAP 990455N and 990453N
Self-adhesive rails (only for 15 mm 0.591 in MG-TAP)



RT... rail marker holders & protective covers

For MG-TAP labels



RTR-TAP

1SNB700114F0000

Description

- Provide an alternative to direct marking on components,
- Compatible with MG-TAP labels with a width of 15 mm (0.591 in),
- Non-deformable up to 90°C, resistant to acid, alcohol, solvents,
- Made of rigid dielectric high-impact PVC .

Main technical data

Material	Flammability	Temperature range
Rigid dielectric high-impact PVC	V0	+10°C to +40°C +50°F to +104°F

Ordering details

Dimensions	Nb. of markers per card	Color	Type	Part Number	Pkg	Weight
mm in					pce	(1 pce) g

RTR-TAP

Pre-drilled rail

15 x 430	0.591 x 16.929	Black <input checked="" type="checkbox"/>	RTR-TAP 990454	1SNB990454R0000	25	37.60
		Grey <input type="checkbox"/>	RTR-TAP 990452	1SNB990452R0000	25	0.50

RTA-TAP

Self-adhesive rail

15 x 430	0.591 x 16.929	Black <input checked="" type="checkbox"/>	RTA-TAP 990455N	1SNB990455R0000	25	19.50
		Grey <input type="checkbox"/>	RTA-TAP 990453N	1SNB990453R0000	25	0.50

RT-CCP

Protective cover

15 x 430	0.591 x 16.929	Transparent <input checked="" type="checkbox"/>	RT-CCP 990456	1SNB990456R0000	25	12.60
----------	----------------	---	---------------	-----------------	----	-------

3

1SNB160222S0201

MG-TAPW component and equipment markers

Precut blank labels



1SNB160137F0014

MG-TAPW

Description

- 9 mm 0.354 in width versatile label used to identify a wide range of devices,
- Use with label rail holders RTA-TAPW 990653N,
- Made of rigid PVC.

Main technical data

Material	Flammability	Temperature range
Rigid PVC	V0	-30°C to +80°C -22°F to +176°F

Ordering details

Dimensions		Nb. of markers per card	Color	Type	Part Number	SW code	Pkg	Weight
mm	in							
9 x 12	0.354 x 0.472	88	Yellow <input checked="" type="checkbox"/>	MG-TAPW 49042N	1SNB049042R0912	360	2200	0.10
9 x 15	0.354 x 0.591	77	White <input type="checkbox"/>	MG-TAPW 49093N	1SNB049093R0915	361	1925	0.20
9 x 20	0.354 x 0.787	55	Yellow <input checked="" type="checkbox"/>	MG-TAPW 49043N	1SNB049043R0915	361	1925	0.20
			White <input type="checkbox"/>	MG-TAPW 49090N	1SNB049090R0920	362	2750	0.20
9 x 29	0.354 x 1.142	30	White <input type="checkbox"/>	MG-TAPW 49096	1SNB049096R0929	363	1500	0.30
			Yellow <input checked="" type="checkbox"/>	MG-TAPW 49040N	1SNB049040R0920	362	2750	0.60
9 x 35	0.354 x 1.378	33	White <input type="checkbox"/>	MG-TAPW 49096	1SNB049096R0929	363	1500	0.30
			Yellow <input checked="" type="checkbox"/>	MG-TAPW 49046	1SNB049046R0929	363	1500	0.30
			White <input type="checkbox"/>	MG-TAPW 49091N	1SNB049091R0935	364	1650	0.40

Marking system accessories

MG2-PLT

Support plate

Included in the MG3 Kit	MG2-PLT 991002	1SNB991002R0000	1	148.50
-------------------------	----------------	-----------------	---	--------

Compatible holders



PEAD

(only for MG-TAPW 49096 and 49046)

RTA-TAPW self-adhesive rail marker holders

For MG-TAPW labels



1SNB700116F0000

RTA-TAPW

Description

- Provide an alternative to direct marking on components,
- Compatible with 9 mm 0.354 in MG-TAPW labels,
- Non-deformable up to 90°C, resistant to acid, alcohol, solvents.

Main technical data

Material	Flammability	Temperature range
Rigid dielectric high-impact PVC	V0	+10°C to +40°C +50°F to +104°F

Ordering details

Dimensions		Nb. of markers per card	Color	Type	Part Number	Pkg	Weight
mm	in						

RTA-TAPW

Self-adhesive rail

9 x 430	0.354 x 16.929		Grey <input type="checkbox"/>	RTA-TAPW 990653N	1SNB990653R0000	25	47.50
---------	----------------	--	-------------------------------	------------------	-----------------	----	-------



MG-TAP-CCS component and equipment markers

Precut transparent labels



1SNB990513R1549

MG-TAP-CCS

Description

- To be directly printed,
- Can also be used as a protective cover with 15 mm 0.591 in MG-TAP or MG-TAPW labels and 15 mm 0.591 in RTR-TAP and RTA-TAP legend rails,
- Made of rigid PVC.

Main technical data

Material	Flammability	Temperature range
Rigid PVC	V0	-30°C to +80°C -22°F to +176°F

Ordering details

Dimensions		Nb. of markers per card	Color	Type	Part Number	SW code	Pkg	Weight
mm	in							
15 x 49	0.591 x 1.929	12	Transparent	<input checked="" type="checkbox"/> MG-TAP-CCS 990513	1SNB990513R1549	167	600	0.90
15 x 67	0.591 x 2.638	6	Transparent	<input checked="" type="checkbox"/> MG-TAP-CCS 990514	1SNB990514R1567	168	300	1.30

Marking system accessories



MG2-PLT

Support plate

Included in the MG3 Kit		MG2-PLT 991002	1SNB991002R0000		1	148.50
-------------------------	--	----------------	-----------------	--	---	--------

Mounting instruction

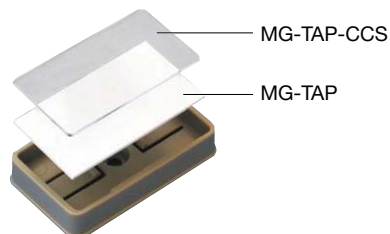

Compatible holders



RTR-TAP 990454 and 990452
Pre-drilled rails



RTA-TAP 990455N and 990453N
Self-adhesive rails

1SNB990513R1549

MG-TAR component and equipment markers

Precut blank labels



1SNB045194R0014

MG-TAR 45194

Description

- Designed to fit particular components with a suitable clip-in location,
- Made of rigid PVC.

Main technical data

Material	Flammability	Temperature range
Rigid PVC	V0	-30°C to +80°C -22°F to +176°F

Ordering details

Dimensions		Nb. of markers per card	Color	Type	Part Number	SW code	Pkg	Weight
mm	in							
17 x 35	0.669 x 1.378	18	White	<input type="checkbox"/> MG-TAR 45194	1SNB045194R1735	711	900	0.60
17 x 44	0.669 x 1.732	12	White	<input type="checkbox"/> MG-TAR 45195	1SNB045195R1744	717	600	0.90

Marking system accessories

MG2-PLT

Support plate

Included in the MG3 Kit	MG2-PLT 991002	1SNB991002R0000	1	148.50
-------------------------	----------------	-----------------	---	--------



Compatible holders



PEB
(only for MG-TAR 45194)



LH-R1
(only for MG-TAR 45194)



MG-PLC component and equipment markers

Precut blank labels

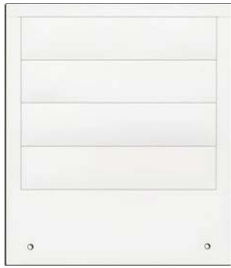

1SNC160141F0014

MG-PLC 71092

Description

- To be used for PLC's marking,
- Direct application on PLC to replace the neutral plates supplied as original equipment,
- Made of rigid PVC.

Main technical data

Material	Flammability	Temperature range
Rigid PVC	V0	-30°C to +80°C -22°F to +176°F

Ordering details

Dimensions		Nb. of markers per card	Color	Type	Part Number	SW code	Pkg	Weight
mm	in							
12.7 x 50	0.500 x 1.969	14	White <input type="checkbox"/>	MG-PLC 71092	1SNB071092R0012	884/886	700	0.40
			Yellow <input type="checkbox"/>	MG-PLC 71042	1SNB071042R0012	884/886	700	0.50
			Siemens Green <input type="checkbox"/>	MG-PLC 71052	1SNB071052R0012	884/886	700	0.80
			Grey <input type="checkbox"/>	MG-PLC 71002	1SNB071002R0012	884/886	700	0.40
17.5 x 103.5	0.689 x 4.075	6	White <input type="checkbox"/>	MG-PLC 71090	1SNB071090R0017	880	300	2.20
			Yellow <input type="checkbox"/>	MG-PLC 71040	1SNB071040R0017	880	300	2.00
			Siemens Green <input type="checkbox"/>	MG-PLC 71050	1SNB071050R0017	880	300	2.20
			Grey <input type="checkbox"/>	MG-PLC 71000	1SNB071000R0017	880	300	1.00
22.75 x 103.5	0.896 x 4.075	4	White <input type="checkbox"/>	MG-PLC 71091	1SNB071091R0022	883	200	2.90
			Yellow <input type="checkbox"/>	MG-PLC 71041	1SNB071041R0022	883	200	2.80
			Siemens Green <input type="checkbox"/>	MG-PLC 71051	1SNB071051R0022	883	200	3.00
			Grey <input type="checkbox"/>	MG-PLC 71001	1SNB071001R0022	883	200	1.00
25 x 50	0.984 x 1.969	8	White <input type="checkbox"/>	MG-PLC 71094	1SNB071094R0025	887/888	400	1.00
			Yellow <input type="checkbox"/>	MG-PLC 71044	1SNB071044R0025	887/888	400	0.90

Marking system accessories

MG2-PLT

Support plate

Included in the MG3 Kit	MG2-PLT 991002	1SNB991002R0000	1	148.50
-------------------------	----------------	-----------------	---	--------



Mounting instruction

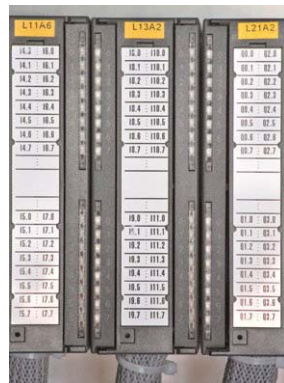

1SNC160182S0201



MG-VRT-A panel plates

Self-adhesive blank panel plates



1SNB088903R0052

MG-VRT-A 88903

Description

- To be used in identifying panels and cabinets with technical data or logos,
- Made of rigid PVC.

Main technical data

Material	Flammability	Temperature range
Rigid PVC	V0	-30°C to +80°C -22°F to +176°F

Ordering details

Dimensions	Nb. of markers per card	Color	Type	Part Number	SW code	Pkg	Weight
mm						marker	marker
	in						g

Self-adhesive panel plate for direct application on suitable surfaces

52 x 107	2.047 x 4.213	2	White	MG-VRT-A 88903	1SNB088903R0052	204	50	9.90
----------	---------------	---	-------	----------------	-----------------	-----	----	------



Marking system accessories

MG2-PLT

Support plate

Included in the MG3 Kit			MG2-PLT 991002	1SNB991002R0000		1	148.50
-------------------------	--	--	----------------	-----------------	--	---	--------

MG-VRT-R panel plates

Blank panel plates



1SNB048903R0052

MG-VRT-R 48903

Description

- To be used in identifying panels and cabinets with technical data or logos,
- To be fixed with rivets,
- Made of rigid PVC.

Main technical data

Material	Flammability	Temperature range
Rigid PVC	V0	-30°C to +80°C -22°F to +176°F

Ordering details

Dimensions	Nb. of markers per card	Color	Type	Part Number	SW code	Pkg	Weight
mm						marker	marker
	in						g

Rivet fixing panel plate

52 x 107	2.047 x 4.213	2	White	MG-VRT-R 48903	1SNB048903R0052	204	100	6.40
----------	---------------	---	-------	----------------	-----------------	-----	-----	------



Marking system accessories

MG2-PLT

Support plate

Included in the MG3 Kit			MG2-PLT 991002	1SNB991002R0000		1	148.50
-------------------------	--	--	----------------	-----------------	--	---	--------

Mounting instruction

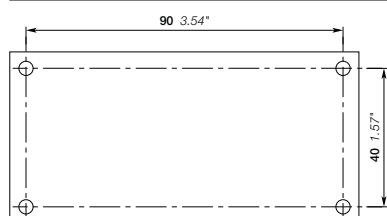





4

Solution series

Blank markers and labels for AMS 600 and AMS 250 plotter

AMS 600 and AMS 250 plotter	76
AMS kit and accessories	78



Terminal block identification

Selection guide for terminal block markers		80	
Terminal block markers	MC...PA	for SNK series	82
	RC...10	for SNA and Solution series	83
	RC55, RC65, RCAL85	for SNA and Solution series	84
	RCT...	for top marking	85
	RB-12W7		86
	RPEV	for PEV label holder	87
	RTM7	strip labels	88
	REH3	for Solution series	89
End stop markers	MCLH, MCLH-R1		90
	RCPEAD		92
	RPEH		93
	RCPEB, PIB, PIB3		94
End stop label holders and covers	LH, LH-R1	for SNK series	91
	PEAD, EPR2	for SNA and Solution series	92
	PEB, PEBM, EPR1	for SNA and Solution series	95



Wire and cable identification

Selection guide for wire and cable markers		96	
Wire and cable markers	WM	PVC label (need label holder)	98
	PCGS	large label (need label holder)	100
Wire and cables label holders	RING, SNAP, RINGT23	transparent label holder	99
	RINGT209	for large label tied-on thick cables	100

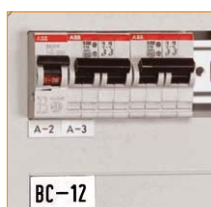

Component and equipment identification

Self-adhesive labels	RPA, PIB2		102
	PSP	for engraving job	103
	PAM	for strip identification	104
Pre-cut labels	BA4	for contactors, relays...	105
	PPB	two-colored label	106
Label holders and covers	PAM10015,PCT	15 mm rail and protective cover	107
	KA1-8120	push-button marker holder	107



Panel identification

Self-adhesive panel plates	PAT		108
Rivet fixing panel plates	PPT		108

AMS 600 and AMS 250 plotter

The universal standard for printing jobs



AMS 600

Universal printing plotter

Compatible with all original manufacturer terminal block markers (polyamide), it can also print other identification supports such as: wire and cable markers, push buttons, panels... This plotter offers a large working area, hosting up to 4 different support plates for one plot job.

Error detection mode

The A3 panel automatically recognises the support plate and avoids the need to select marking elements, it also warns the user when the support is wrongly installed.

Dry out protection system

Pens are prevented from drying out thanks to AMS 600 integrated pen station.



AMS 250

Compact

This A4 plotter is smaller than AMS 600 and is more suited to a cluttered environment.

Automatic installation

The installation program starts automatically. The computer just needs to be rebooted after it has finished and printing can start.

What you see is what you get !

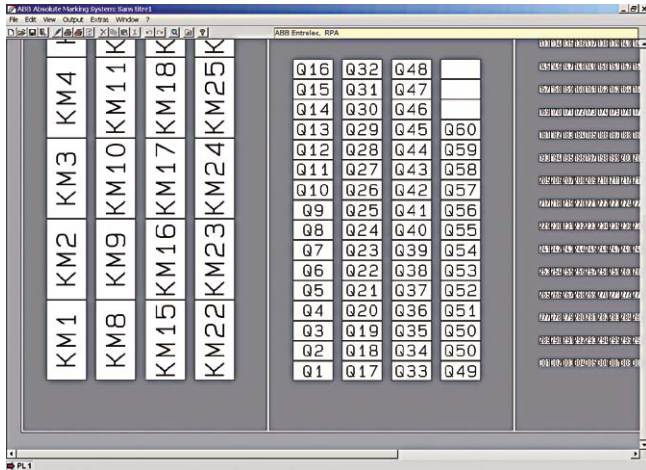

User friendly
Microsoft® Windows® software

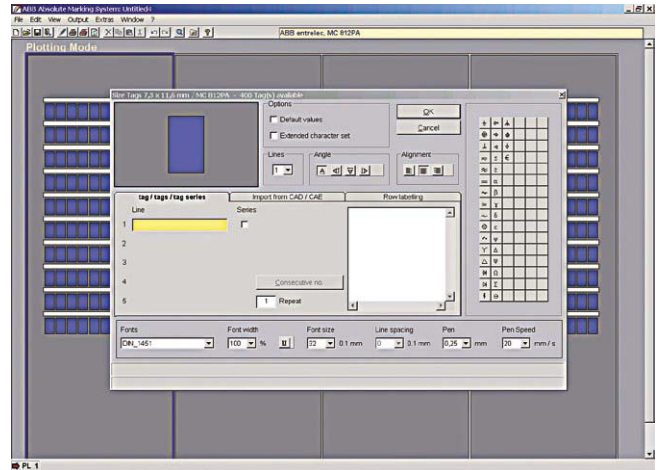

Time saving: data import function
from CAD, TXT and Excel® files



New special ink disposable plotter pens ED-R

- Disposable pens ED-R almost never clog, they are ideal for use in particularly dry environments.
- These pens are filled with the permanent ink ED, most suitable for marking various plastic surfaces.
- The ED ink should only be used on plastic material. Do not clean or touch with aggressive fluids.
- For applications outside of the control panel the ink P 2.0 is more suitable and durable.

AMS plotter

Kit and accessories



AMS 600

AMS 600

Description

- For basic marking applications,
- Economic,
- Full-size format,
- Print original manufacturers' markers.

Ordering details

Description	Color	Type	Part Number	Pkg pce	Weight (1 pce) g
AMS 600 Plotter KIT		AMS 600 KIT	1SNA360000R2400	1	12600
List of items included in the KIT:					
1 AMS 600 plotter pen printer		AMS 600			
1 Software CD		AMS SOFTWARE			
1 Power supply cable		AMS POWER			
1 USB cable		AMS USB			
1 Support plate for RC / MC / RCTT / WMTT / BA4 / RCT		SPRC1			
1 Support plate for MC...PA		SPRC 30-3			
1 Plotter pen Ø 0.25 mm .01 in		AMS PEN 0.25			
1 Plotter pen Ø 0.35 mm .014 in		AMS PEN 0.35			
5 Ink cartridges		AMS INK CARTRIDGES			
1 Cleaner fluid		AMS CLEANER FLUID			
1 Cleaner kit		AMS CLEANER KIT			



AMS 250

AMS 250

Description

- Basic needs,
- Economic,
- Half-size format
- Compatible with most of AMS 600 accessories.

Ordering details

Description	Color	Type	Part Number	Pkg pce	Weight (1 pce) g
AMS 250 Plotter KIT		AMS 250 BASIC KIT	1SNA360000R2500	1	8800
List of items included in the KIT:					
1 AMS 250 plotter pen printer		AMS 250 BASIC			
1 Software CD		AMS SOFTWARE			
1 Power supply cable		AMS POWER			
1 USB cable		AMS USB			
1 Support plate for BA4 / MC / RC / RCAL / RCT / RCTT		SPRC2			
1 Disposable plotter pen Ø 0.25 mm .01 in EDR ink		DISPOSABLE AMS PEN ED-R 0.25			
1 Disposable plotter pen Ø 0.35 mm .014 in EDR ink		DISPOSABLE AMS PEN ED-R 0.35			

AMS plotter

Kit and accessories

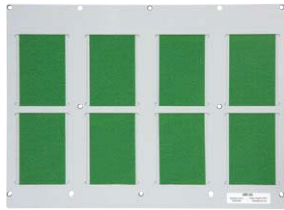

SPRC1

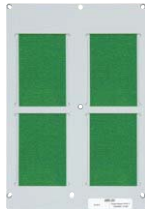

SPRC2



SPRC30-3

Support plates for TE Connectivity markers

Description	Compatibility		Type	Part Number	Pkg pce	Weight (1 pce) g
	AMS 500 AMS 600	AMS 250				
Support plates for:						
RC/MC/RCTT/WMTT/BA4/RCT full format	●		SPRC 1	1SNA360010R1500	1	1500.00
RC/MC/RCTT/WMTT/BA4/RCT		●	SPRC 2	1SNA360011R1500	1	600.00
RB strips	●	●	SPRC 4	1SNA360014R0500	1	300.00
RTM7-9	●		SPRC 5	1SNA360015R0600	1	1700.00
PIB	●	●	SPRC 13	1SNA360023R0600	1	260.00
BA5-50	●	●	SPRC 14	1SNA360024R0700	1	300.00
RC-X10A	●	●	SPRC 15	1SNA360025R0000	1	300.00
2 RC cards	●	●	SPRC 16	1SNA360026R0100	1	300.00
WM markers	●	●	SPRC 26	1SNA360036R0300	1	300.00
PAM strip	●	●	SPRC 27	1SNA360037R0400	1	300.00
RPCV markers	●	●	SPRC 28	1SNA360040R2300	1	300.00
RCL, P, W510	●	●	SPRC 29	1SNA360038R1500	1	300.00
MC... PA	●	●	SPRC 30-3	1SNA360039R1700	1	500.00
A4 universal support plate	●	●	SPRC 21	1SNA360031R0600	1	500.00

Support plates for other manufacturers

Description	Compatibility		Type	Part Number	Pkg pce	Weight (1 pce) g
	AMS 500 AMS 600	AMS 250				
Support plates for markers:						
Wieland	●	●	SPRC 6	1SNA360016R0700	1	350.00
Weidmüller	●	●	SPRC 7	1SNA360017R0000	1	400.00
Phoenix ZBM 5/6	●	●	SPRC 8	1SNA360018R1100	1	300.00
Phoenix ZB	●	●	SPRC 9	1SNA360019R1200	1	300.00
Allen Bradley WRZ	●	●	SPRC 10	1SNA360020R1700	1	330.00
Wago mini WSBS	●	●	SPRC 11	1SNA360021R0400	1	300.00

Accessories

Description	Diameter Color	Type	Part Number	Pkg pce	Weight (1 pce) g
	Ø 0.25 mm 0.01 in	White □ AMS PEN 0.25	1SNA360100R2500	1	15.00
	Ø 0.35 mm 0.014 in	Yellow ■ AMS PEN 0.35	1SNA360101R1200	1	15.00
	Ø 0.50 mm 0.02 in	Brown ■ AMS PEN 0.50	1SNA360104R1500	1	26.00
	Ø 0.70 mm 0.028 in	Blue ■ AMS PEN 0.70	1SNA360105R1600	1	26.00
	Ø 1.00 mm 0.039 in	Orange ■ AMS PEN 1.00	1SNA360106R1700	1	26.00
Disposable plotter pen P 2.0 black ink	Ø 0.25 mm 0.01 in	White □ DISPOSABLE AMS PEN 0.25	1SNA360120R1000	1	24.00
	Ø 0.35 mm 0.014 in	Yellow ■ DISPOSABLE AMS PEN 0.35	1SNA360121R0500	1	24.00
Disposable plotter pen ED-R black ink	Ø 0.18 mm 0.007 in	Red ■ DISPOSABLE AMS PEN ED-R 0.18	1SNA360124R1000	1	24.00
	Ø 0.25 mm 0.01 in	White □ DISPOSABLE AMS PEN ED-R 0.25	1SNA360122R1000	1	24.00
	Ø 0.35 mm 0.014 in	Yellow ■ DISPOSABLE AMS PEN ED-R 0.35	1SNA360123R0500	1	24.00
5 ink cartridges 1 ml		AMS INK CARTRIDGES	1SNA360150R2600	1	18.00
2 cleaner fluid bottles, 2x10 ml		AMS CLEANER FLUID	1SNA360155R1700	1	40.00
Cleaner kit including: 1 rinse bottle and 1 blotting paper		AMS CLEANER KIT	1SNA360156R1000	1	34.00
Dust cover		DUST COVER	1SNA360161R1500	1	200.00
Service kit for pen maintenance		SERVICE KIT FOR AMS 600	1SNA360162R1600	1	12.00
Self-adhesive support for support plate SPRC 1		SPDST1	1SNA360163R1700	1	70.00
Plotter head for AMS 600 including 1 printing module, 1 pen holder and 1 dust cover		PEN HOLDER	1SNA360098R1200	1	85.00



AMS PEN



AMS CLEANER KIT

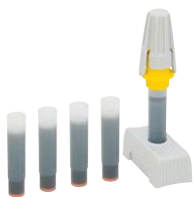















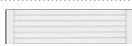































AMS INK CARTRIDGES











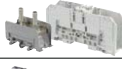

AMS 600 / AMS 250 markers selection guide

Terminal block blank markers selection guide











Terminal blocks

Connection technology	Terminal block part number	Marker type	Marker mounting
Screw clamp 	1SNK... 	Individual marker 	Top and side marking 
	1SNA... 	Individual marker 	Side marking 
		Strip label 	Top marking 
		Individual marker 	Side marking 
	1SNA... Miniblocks (MS...) 	Individual marker 	Side marking 
1SNA... Miniblocks (DR...) 	Individual marker 	Side marking 	
PI-Spring and pluggable PI-Spring 	1SNK... 	Individual marker 	Top and side marking 
Spring clamp 	1SNA... 	Individual marker 	Top marking 
	1SNA... Miniblocks 	Individual marker 	Side marking 
ADO System® 	1SNA... 	Individual marker 	Side marking 
		Strip label 	Top marking 
	1SNA... Miniblocks 	Individual marker 	Top marking 
		Individual marker 	Side marking 
Spring loaded screw clamp 	1SNA... 	Individual marker 	Top marking 
		Strip label 	Top marking 
		Individual marker 	Side marking 

Special terminal blocks spacing

Connection technology	Terminal block	Marker type	Marker mounting
Ring lug 	1SNA... 	Individual marker 	Top and side marking 
Stud 	1SNA... 	Individual marker 	Top and side marking 
Screw clamp pluggable terminal block 	1SNA... 	Individual marker 	Side marking 
		Strip label 	Top marking (MA2.5/5-CPE) 

SNK series end stop and label holders

BAZ1 	Individual marker 	Top marking 	MC512PA
BAM4 	Individual marker 	Top and side marking 	MC812PA
LH (label holder for BAM4, BAZH1, BAZ1) 	Label 	Top marking 	MC-LH
LH-R1 (label holder for BAM4, BAZH1, BAZ1) 			MC-LHR1























Spacing												
4 mm	5 mm	5.2 mm	6 mm	8 mm	10 mm	12 mm	16 mm	22 mm	26 mm	31 mm	36 mm	
0.157 in	0.197 in	0.205 in	0.236 in	0.315 in	0.394 in	0.472 in	0.630 in	0.866 in	1.024 in	1.220 in	1.417 in	
		MC512PA	MC612PA	MC812PA	MC812PA (1)							
	RC510		RC610	RC810	RC1010	RC1010 (1)						
	RC510		RCT610	RCT810								
	RTM9	RTM7										
			RC610	RC810								
RC410	RC55		RC65	RC810								
		MC512PA	MC612PA	MC812PA	MC812PA (1)							
RC410	RC510		RC610	RC810	RC1010	RC1010 (1)						
	RC55		RC65	RCAL85								
	RC55				RC55							
	RC510		RC610	RC810								
			RCT610	RCT810								
		RTM7										
	RC55		RC65	RCAL85								
			RC610	RC810	RC1010							
			RCT610	RCT810								
					RTM9							

(1) Marker width < marking's area size - markers must be mounted individually.

Spacing												
5.08 mm	7.62 mm	9.5 mm	12.5 mm	13 mm	16 mm	26 mm	27 mm	31 mm	32 mm	35 mm	42 mm	55 mm
0.200 in	0.300 in	0.374 in	0.492 in	0.512 in	0.630 in	1.024 in	1.063 in	1.220 in	1.260 in	1.378 in	1.654 in	2.165 in
		RCT810		RC1010 / REH3	REH3							
						PEP + RC610	RC810 (1)	PEP + RC610	RC810 (1)	PEP + RC610	RC810 (power) PEP+RC610 (stud)	RC810 (1)
RC510	RB-12W7											
RTM7												

(1) Marker width < marking's area size - markers must be mounted individually.

SNA series end stop and label holders

BAM2, BADH		Individual marker		Top and side marking		RC1010
BADL		Individual marker		Top marking		RC810
BADRL, BAR		Individual marker		Top marking		RC610
BAMH		Individual marker		Top marking		RC1010
PEAD (Label holder for BAM2 and BADL)		Label		Top marking		RCPEAD
PEB (Label holder for BAM2, BADL, BADH, BAMH, BAR and BADRL)		Label		Top marking		PIB
PEH (Label holder for BAM2, BADL, BADH, BAMH, BAR and BADRL)		Label		Top marking		RPEH

15NC160216S0201

MC..PA terminal block markers

Blank markers for SNK series



1SNK160024FC014

MC512PA

Description

- Blank marker card in polyamide,
- Terminal blocks are directly independent after strip mounting,
- Improved marking visibility thanks to the increased marking surface +20% (12 mm 0.472 in).

Main technical data

Material	Flammability
Polyamide	V2

Ordering details

Dimensions		Maximum printed digits		Nb. of markers per card	Color	Type	Part Number	Pkg	Weight
mm	in	Hor.	Vert.					card	(1 card) g

For 5.2 mm 0.205 in spacing



MC512PA										
12 x 5	0.472 x 0.197	3	8	100	White	<input type="checkbox"/>	MC512PA	1SNK149999R0000	20	10.00

For 6 mm 0.236 in spacing



MC612PA										
12 x 5.6	0.472 x 0.220	3	8	100	White	<input type="checkbox"/>	MC612PA	1SNK159999R0000	20	11.00

For 8 mm 0.315 in spacing



MC812PA										
12 x 7.6	0.472 x 0.299	4	8	100	White	<input type="checkbox"/>	MC812PA	1SNK169999R0000	20	14.00



Marking system accessories

SPRC 30-3

Support plate for AMS600 and AMS250

Included in KIT MAO AMS 600 only	SPRC 30-3	1SNA360039R1700	1	500.00
----------------------------------	-----------	-----------------	---	--------

Mounting instruction



1SNC160133S0201

RC..10 terminal block markers

Blank markers for SNA and solution series

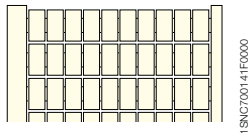

1SNC700141F000

RC510

Description

- Blank card in polyamide,
- Terminal blocks are directly independent after strip mounting,
- To be used to mark spring clamp, ADO System® and screw clamp pluggable SNA terminal blocks.

Main technical data

Material	Flammability
Polyamide	V2

Ordering details

Dimensions	Maximum printed digits		Nb. of markers per card	Color	Type	Part Number	Pkg card	Weight (1 card) g
	mm	in						

For 4 mm 0.157 in terminal block spacing



RC410

10 x 4	0.394 x 0.157	2	7	100	White <input type="checkbox"/>	RC410	1SNA229000R1500	10	5.20
--------	---------------	---	---	-----	--------------------------------	-------	-----------------	----	------

For 5 mm 0.197 in terminal block spacing



RC510

10 x 5	0.394 x 0.197	3	7	100	White <input type="checkbox"/>	RC510	1SNA231000R0700	10	5.20
		4	4		Yellow <input type="checkbox"/>	RC510-YL	1SNA103890R2100		

For 6 mm 0.236 in terminal block spacing



RC610

10 x 6	0.394 x 0.236	4	4	100	White <input type="checkbox"/>	RC610	1SNA233000R0100	10	6.70		
					Blue <input type="checkbox"/>	RC610	1SNA206233R0000			10	6.70
					Orange <input type="checkbox"/>	RC610	1SNA206232R0700			10	6.70
					Yellow <input type="checkbox"/>	RC610	1SNA206231R0600			10	6.70
					Green <input type="checkbox"/>	RC610	1SNA206230R1100			10	6.70
					Red <input type="checkbox"/>	RC610	1SNA206235R0200			10	6.70

For 8 mm 0.315 in terminal block spacing



RC810

10 x 8	0.394 x 0.315	4	4	100	White <input type="checkbox"/>	RC810	1SNA234000R0200	10	8.20
--------	---------------	---	---	-----	--------------------------------	-------	-----------------	----	------

For 10 mm 0.394 in terminal block spacing



RC1010

10 x 10	0.394 x 0.394	7	7	80	White <input type="checkbox"/>	RC1010	1SNA238000R1600	10	1.30
---------	---------------	---	---	----	--------------------------------	--------	-----------------	----	------

Marking system accessories

SPRC 1

Support plate for AMS600

Included in KIT MAO AMS 600	SPRC 1	1SNA360010R1500	1	1500.00
-----------------------------	--------	-----------------	---	---------

SPRC 2

Support plate for AMS250

Included in AMS 250 BASIC KIT	SPRC 2	1SNA360011R1500	1	600.00
-------------------------------	--------	-----------------	---	--------

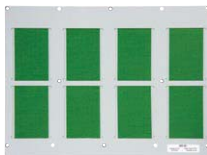

Mounting instruction



RC55, RC65, RCAL85 terminal block markers

Blank markers for SNA and Solution series

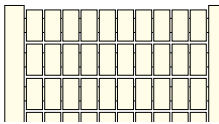

1SNC700141F000

RC55

Description

- Blank card in polyamide,
- Terminal blocks are directly independent after strip mounting,
- To be used to mark screw clamp (1) and spring clamp (side mounting) SNA terminal blocks, and all Mini-blocks.

Main technical data

Material	Flammability
Polyamide	V2

Ordering details

Dimensions		Maximum printed digits		Nb. of markers per card	Color	Type	Part Number	Pkg card	Weight (1 card) g
mm	in	Hor.	Vert.						

For 5 mm 0.197 in terminal block spacing



RC55										
5 x 5	0.197 x 0.197	3	3	100	White	<input type="checkbox"/>	RC55	1SNA230000R1200	10	2.90

For 6 mm 0.236 in terminal block spacing



RC65										
5 x 6	0.197 x 0.236	3	3	100	White	<input type="checkbox"/>	RC65	1SNA232000R0000	10	3.60
					Blue	<input type="checkbox"/>	RC65	1SNA103775R0000	10	3.40
					Red	<input type="checkbox"/>	RC65	1SNA103776R0100	10	3.40

For 8 mm 0.315 in terminal block spacing (1)



RCAL85										
5 x 8	0.197 x 0.315	5	3	100	White	<input type="checkbox"/>	RCAL85	1SNA237000R0500	10	2.90

Marking system accessories

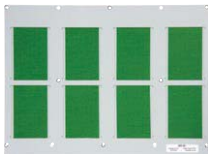

SPRC 1

Support plate for AMS600

Included in KIT MAO AMS 600	SPRC 1	1SNA360010R1500	1	1500.00
-----------------------------	--------	-----------------	---	---------



SPRC 2

Support plate for AMS250

Included in AMS 250 BASIC KIT	SPRC 2	1SNA360011R1500	1	600.00
-------------------------------	--------	-----------------	---	--------

(1) RCAL85 not compatible with screw clamp terminal blocks

Mounting instruction

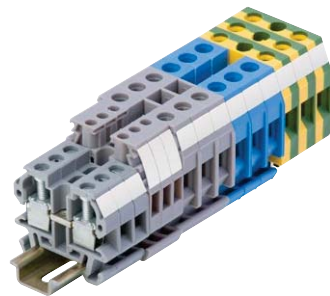



RCT.. terminal block markers

Blank markers for SNA and Solution series

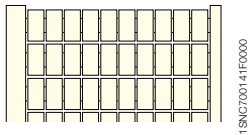

1SNC700141F000

RCT610

Description

- Blank card in polyamide,
- Terminal blocks are directly independent after strip mounting,
- To be used for top marking of screw clamp and ADO System® terminal blocks from the SNA and Solution series.

Main technical data

Material	Flammability
Polyamide	V2

Ordering details

Dimensions	Nb. of markers per card	Color	Type	Part Number	Pkg	Weight
mm : in					card	(1 card) g

For 6 mm 0.236 in terminal block spacing



RCT610

10 x 6	0.394 x 0.236	100	White <input type="checkbox"/>	RCT610	1SNA236000R0400	10	6.40
--------	---------------	-----	--------------------------------	--------	-----------------	----	------

For 8 mm 0.315 in terminal block spacing



RCT810

10 x 8	0.394 x 0.315	100	White <input type="checkbox"/>	RCT810	1SNA236500R0600	10	7.60
--------	---------------	-----	--------------------------------	--------	-----------------	----	------

Marking system accessories

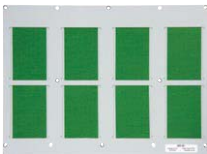

SPRC 1

Support plate for AMS600

Included in KIT MAO AMS 600	SPRC 1	1SNA360010R1500	1	1500.00
-----------------------------	--------	-----------------	---	---------



SPRC 2

Support plate for AMS250

Included in AMS 250 BASIC KIT	SPRC 2	1SNA360011R1500	1	600.00
-------------------------------	--------	-----------------	---	--------

Mounting instruction

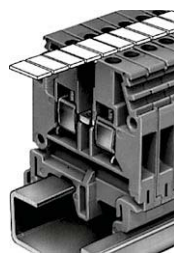

Top marking

RB-12W7 terminal block markers

Blank strip markers for SNA and Solution series

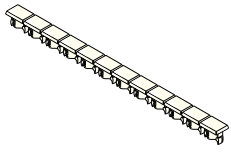

1SNC700164R0000

RB-12W7

Description

- Blank marking strip,
- Strip of 12 markers available in pre-printed on request,
- To be used for top marking of ADO System® pluggable terminal blocks.

Main technical data

Material	Flammability
Polyamide	V2

Ordering details

Dimensions	Nb. of markers per card	Color	Type	Part Number	Pkg card	Weight (1 card) g
mm : in						
RB-12W7						
3.6 x 7.62 : 0.141 x 0.300	12	White <input type="checkbox"/>	RB-12W7	1SNA290455R0700	50	6.00



Marking system accessories

SPRC 4

Support plate for AMS600 and AMS250

Purchased separately		SPRC 4	1SNA360014R0500	1	300.00
----------------------	--	--------	-----------------	---	--------



Mounting instruction

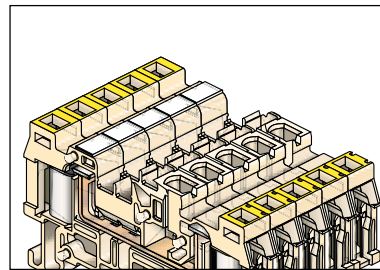

Strip marking

1SNC1601BS0201



RPEV terminal block markers

Precut blank labels for SNA and Solution series



1SNC700163F000

RPEV

Description

- Precut PVC label,
- To be used with PEV pivoting marker holder.

Main technical data

Material	Flammability
PVC	

Ordering details

Dimensions		Nb. of markers per card	Color	Type	Part Number	Pkg card	Weight (1 card) g
mm	in						
RPEV							
6 x 29	0.236 x 1.142	99	White	<input type="checkbox"/> RPEV	1SNA173178R0700	1	9.20

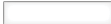

Marking system accessories

SPRC 21

Support plate for AMS600 and AMS250

Purchased separately				SPRC 21	1SNA360031R0600	1	500.00
----------------------	--	--	--	---------	-----------------	---	--------

PEV pivoting terminal block marker holders

For RPEV markers

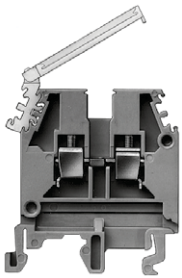

1SNC160192F0014

PEV

Description

- To be slid into 6 mm *0.236 in* spacing terminal blocks,
- Can be placed side by side from 10 mm *0.394 in* spacing,
- The pivoting upper part provides access to the compression screws,
- Designed to be mounted individually.

Main technical data

Material	Flammability

Ordering details

Dimensions		Nb. of markers per card	Color	Type	Part Number	Pkg pce	Weight (1 pce) g
mm	in						
PEV							
Pivoting marker holder							
6 x 29	0.236 x 1.142		Grey	<input type="checkbox"/> PEV	1SNA113180R1200	10	1.00

Dimensions given apply to the labelling area.

Mounting instruction

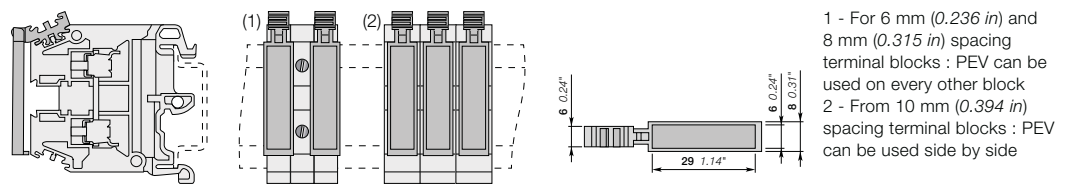

1SNC160119S0201

RTM terminal block markers

Blank strip labels for SNA and Solution series

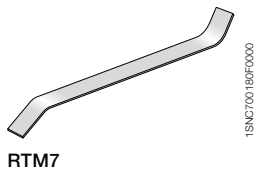

Description

- Blank marking strip,
- To be top mounted by sliding it in terminal blocks.

Main technical data

Material	Flammability
PVC	

Ordering details

Dimensions		Nb. of markers per card	Color	Type	Part Number	Pkg card	Weight (1 card) g
mm	in						

RTM7

For screw clamp and ADO System® terminal blocks from the SNA and Solution series, 6 mm 0.236 in to 12 mm 0.472 in spacing

7.6 x 500	0.299 x 19.685	1	White	<input type="checkbox"/> RTM7	1SNA168410R0700	1	5.00
-----------	----------------	---	-------	-------------------------------	-----------------	---	------



RTM9

For terminal blocks type MA 2.5/5 and M 35/16

10 x 500	0.394 x 19.685	1	White	<input type="checkbox"/> RTM9	1SNA164602R0000	1	5.00
----------	----------------	---	-------	-------------------------------	-----------------	---	------



Marking system accessories

SPRC 5

Support plate for AMS600

Purchased separately				SPRC 5	1SNA360015R0600	1	1700.00
----------------------	--	--	--	--------	-----------------	---	---------

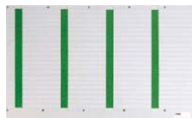

Mounting instruction

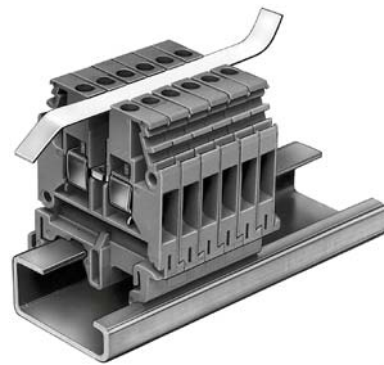

REH3 terminal block markers

Precut blank labels for Solution series



REH3

1SNA163155R2600

Description

- Precut blank labels in cellulose acetate,
- Terminal blocks are directly independent after mounting,
- To be used to mark 13 mm 0.512 in or 16 mm 0.630 in spacing ring lug terminal blocks from the Solution series.

Main technical data

Material	Flammability
Cellulose Acetate	V2

Ordering details

Dimensions	Nb. of markers per card	Color	Type	Part Number	Pkg	Weight
mm : in					card	(1 card) g
REH3						
7 x 5	0.276 x 0.197	680	White <input type="checkbox"/> REH3	1SNA163155R2600	1	20.00



Marking system accessories

SPRC 21

Support plate for AMS600 and AMS250

Purchased separately	SPRC 21	1SNA360031R0600	1	500.00
----------------------	---------	-----------------	---	--------



MCLH end stop markers

Self-adhesive precut blank labels for SNK series

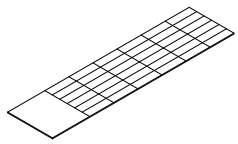

1SNK700301R0000

MCLH, MCLH-R1

Description

– Identify your terminal blocks assembly with the self-adhesive label adapted to the LH label holders.

Main technical data

Material	Flammability	Temperature range
PVC + Adhesive acrylic	V0	-55°C to +110°C -67°F to +230°F

Ordering details

Dimensions	Nb. of markers per card	Color	Type	Part Number	Pkg	Weight
mm : in					card	(1 card) g

For LH label holder

MCLH

30 x 8.8	1.181 x 0.346	36	White <input type="checkbox"/>	MCLH	1SNK900630R0000	25	10.00
			Yellow <input type="checkbox"/>	MCLH-YL	1SNK900633R0000	25	10.00

For LH-R1 label holder

MCLH-R1

35.35 x 17.65	1.392 x 0.695	15	White <input type="checkbox"/>	MCLH-R1	1SNK900631R0000	25	10.00
			Yellow <input type="checkbox"/>	MCLH-R1-YL	1SNK900634R0000	25	10.00

Marking system accessories

SPRC 21

Support plate for AMS600 and AMS250

Purchased separately		SPRC 21	1SNA360031R0600	1	500.00
----------------------	--	---------	-----------------	---	--------



Mounting instruction

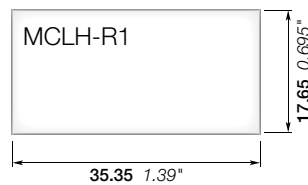
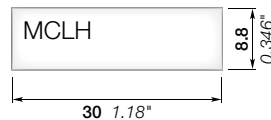

Compatible holders



LH



LH-R1

1SNK160125S0201

LH, LH-R1 end stop label holders

For MCLH labels



1SNK160210FC014

Description

- Easily identify your terminal blocks assembly with white or yellow labels,
- Adjustable in height for best visibility,
- Compatible with all SNK end stops.

Main technical data

Material	Flammability	Temperature range
Polyamide	V0	-55°C to +110°C -67°F to +230°F

Ordering details

Spacing		Dimensions		Color	Type	Part Number	Pkg	Weight
mm	in	mm	in					

For MCLH

LH									
10	0.394	8.8 x 30	0.35 x 1.18	Dark Grey	■	LH	1SNK900605R0000	50	0.60

For MCLH-R1

LH-R1									
19.5	0.768	17.9 x 35.65	0.70 x 1.40	Dark Grey	■	LH-R1	1SNK900607R0000	50	1.10

Dimensions given apply to the labelling area.



LH



LH-R1

Compatible end stops



BAM4
1SNK900001R0000



BAZ1
1SNK900002R0000



BAZH1
1SNK900102R0000

1SNK160129S0201

RCPEAD end stop labels

Precut blank labels

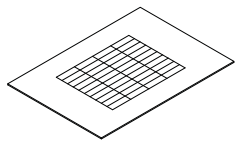

1SNC1700232R0000

RCPEAD

Description

- Identify your terminal block assemblies with the self-adhesive label adapted to the PEAD label holders.

Main technical data

Material	Flammability
PVC	

Ordering details

Dimensions	Nb. of markers per card	Color	Type	Part Number	Pkg	Weight
mm : in					card	(1 card) g
RCPEAD						
9 x 29 : 0.354 x 1.142	40	White <input type="checkbox"/>	RCPEAD	1SNA399725R0600	1	5.00

Marking system accessories

SPRC 21

Support plate for AMS600 and AMS250

Purchased separately		SPRC 21		1SNA360031R0600	1	500.00
----------------------	--	---------	--	-----------------	---	--------



Mounting instruction

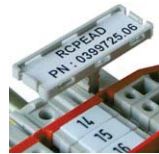

PEAD + RCPEAD

PEAD end stop label holders

For RCPEAD label



1SNC160058FD014

PEAD

Description

- Easily identify your terminal block assemblies with white or yellow labels,
- Adjustable in height for best visibility,
- Compatible with BAM2 and BADL SNA series end stops.

Main technical data

Material	Flammability
Polyamide	V0

Ordering details

Dimensions	Color	Type	Part Number	Pkg	Weight
mm : in				pc	(1 pc) g
PEAD					
9 x 29 : 0.354 x 1.142	Grey <input type="checkbox"/>	PEAD	1SNA399719R1000	20	0.78

EPR2

Card of 20 covers for RCPEAD and RCPEAD-TT markers

9 x 29	0.354 x 1.142	Transparent <input checked="" type="checkbox"/>	EPR2	1SNA399726R0700	1	4.00
--------	---------------	---	------	-----------------	---	------

Dimensions given apply to the labelling area.



Compatible end stops



BAM2
1SNA206351R1600



BADL
1SNA399903R0200



RPEH end stop labels

Precut blank labels

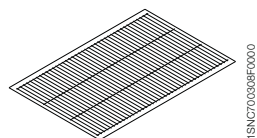

RPEH

1SNCT00369F000

Description

– Blank markers to be slid into PEH holders.

Main technical data

Material	Flammability
PVC	

Ordering details

Dimensions	Nb. of markers per card	Color	Type	Part Number	Pkg	Weight
mm in					card	(1 card) g

RPEH

Precut markers to be slid into PEH 40 x 5 mm 1.575 x .197 in holders

5 x 40	0.197 x 1.575	120	White <input type="checkbox"/>	RPEH	1SNA163007R2600	1	20.00
--------	---------------	-----	--------------------------------	------	-----------------	---	-------



Marking system accessories

SPRC 21

Support plate for AMS600 and AMS250

Purchased separately				SPRC 21	1SNA360031R0600	1	500.00
----------------------	--	--	--	---------	-----------------	---	--------



PEH end stop label holders

For RPEH



PEH

1SNCT162269F0014

Description

– Compatible with marker PEH.

Main technical data

Material	Flammability

Ordering details

Dimensions	Nb. of markers per card	Color	Type	Part Number	Pkg	Weight
mm in					pce	(1 pce) g

PEH

Horizontal label holder for end stop, to be attached across end stop.

5 x 40	0.197 x 1.575		Transparent <input checked="" type="checkbox"/>	PEH	1SNA163211R2600	10	382.00
--------	---------------	--	---	-----	-----------------	----	--------

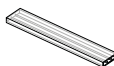

Compatible end stops



BAM2

1SNA206351R1600



BADL

1SNA399903R0200



BADH

1SNA116900R2700



BAMH

1SNA114836R0000



BAR

1SNA164519R2400



BADRL

1SNA199420R2100

1SNCT160123S0201 - Rev. B

RCPEB, PIB, PIB3 end stop markers

Precut blank labels

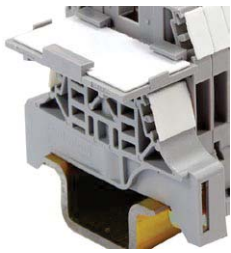

1SNC160120CF0014

RCPEB

Description

- Blank markers to be inserted onto PEB label holder,
- To be used for terminal block assembly identification.

Main technical data

Material	Flammability
PVC	

Ordering details

Dimensions	Nb. of markers per card	Color	Type	Part Number	Pkg	Weight
mm	in				pcs	(1 pcs) g

RCPEB

Card of 54 precut labels to be inserted onto PEB label holder

17.5 x 35	0.689 x 1.378	54	White <input type="checkbox"/>	RCPEB	1SNA178430R0500	1	0.05
-----------	---------------	----	--------------------------------	-------	-----------------	---	------

PIB3

Strip of 7 labels to be inserted onto PEB label holder

17.5 x 35	0.689 x 1.378	7	White <input type="checkbox"/>	PIB3	1SNA235462R2200	50	0.40
-----------	---------------	---	--------------------------------	------	-----------------	----	------

PIB

Individual labels to be inserted onto PEB label holder, white marking on black background

17.5 x 35	0.689 x 1.378	1	Black <input checked="" type="checkbox"/>	PIB	1SNA173812R1300	100	0.60
-----------	---------------	---	---	-----	-----------------	-----	------



Marking system accessories

SPRC 13

Support plate for AMS600 and AMS250

Purchased separately				SPRC 13	1SNA360023R0600	1	260.00
----------------------	--	--	--	---------	-----------------	---	--------



Compatible holders

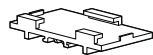

PEB

1SNC160124S0201

PEB end stop label holders

For RCPEB, PIB, PIB3 labels

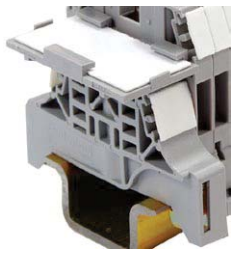

PEB

Description

- To be used for terminal block assembly identification,
- Direct insertion onto end stops from SNA series,
- Compatible with RCPEB, PIB, PIB3 labels.

Main technical data

Material	Flammability	Temperature range
Polyamide (PEB) PVC (EPR1)	V0	-55°C to +110°C -67°F to +230°F

Ordering details

Dimensions	Color	Type	Part Number	Pkg	Weight
mm	in			pce	(1 pce) g

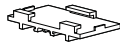

PEB

Label holder for end stop 35 x 17 mm 1.378 x .669 in, to be snapped onto end stop

18 x 35.5	0.709 x 1.378	Grey <input type="checkbox"/>	PEB	1SNA113077R1100	50	1.70
-----------	---------------	-------------------------------	-----	-----------------	----	------



EPR1

Card of 54 PVC protective covers

17.5 x 35	0.689 x 1.378	Transparent <input checked="" type="checkbox"/>	EPR1	1SNA178431R2200	1	0.054
-----------	---------------	---	------	-----------------	---	-------

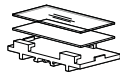

PEBM

"All in one": PEB marker holder with marker and protection included

			PEBM	1SNA113084R0100	50	2.80
--	--	--	------	-----------------	----	------

Compatible end stops



BAM2

1SNA206351R1600



BADL

1SNA399903R0200



BADH

1SNA116900R2700



BAMH

1SNA114836R0000



BAR

1SNA164519R2400



BADRL

1SNA199420R2100

AMS 600, AMS 250 wire and cable markers

Selection guide

Evolutionary and protected wire and cable identification

Each individual label and label holder is easily detached from the stem for installation onto cable. The printed label in its holder is perfectly protected over time.

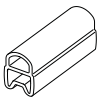

RING

Slide-on cable label holders to be used before connecting the wires.

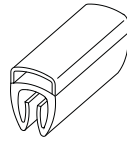

SNAP

Clip-on cable label holders to be snap-on the wire already connected or not.

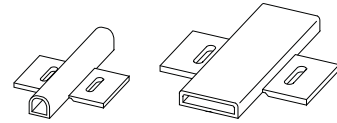

RINGT

Tie-on cable label holders recommended for thick tube, hose and conduit.

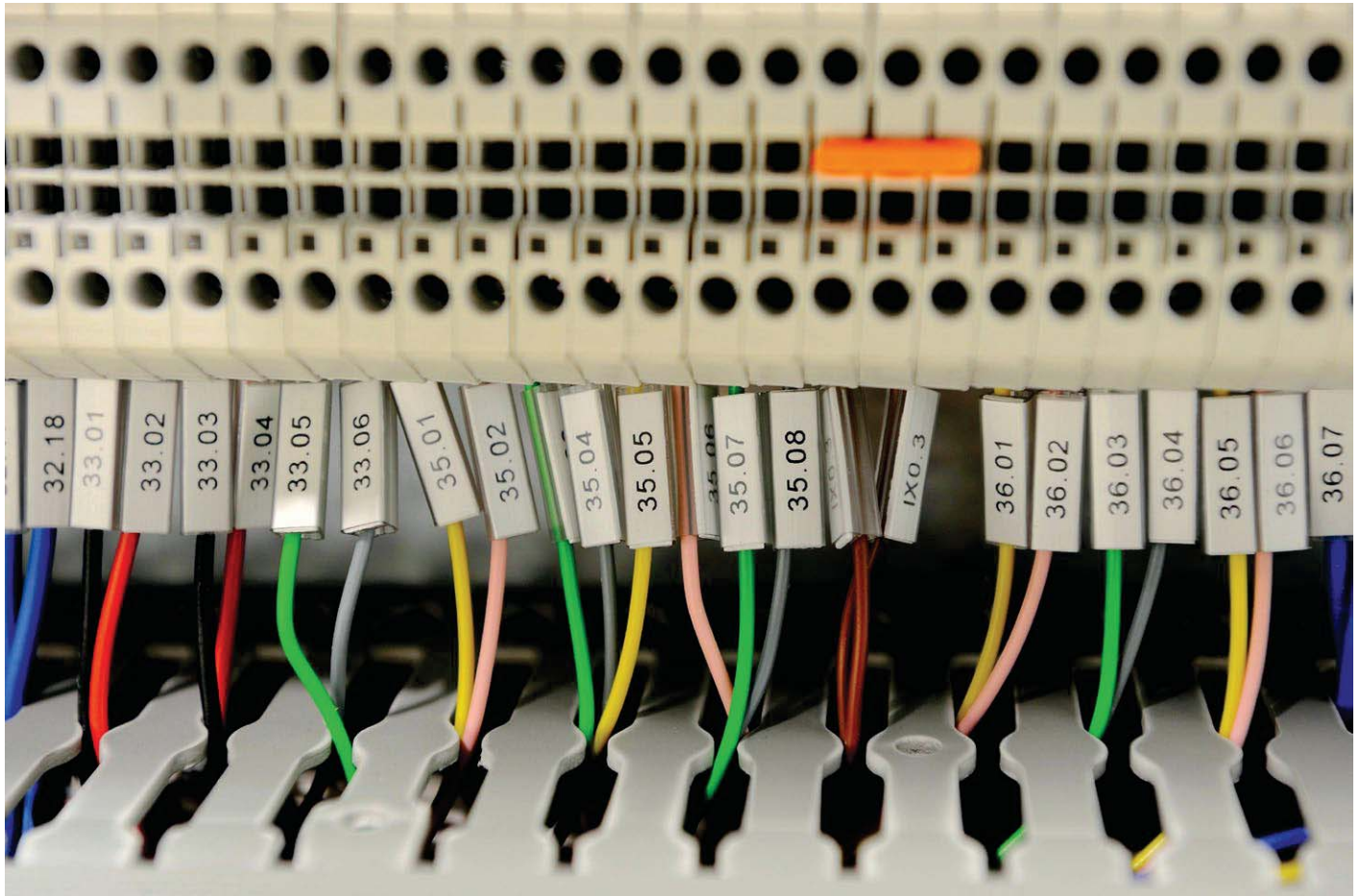

1SNC160217S0201

For evolutive identification

Marker holders + slide-in markers

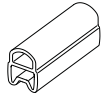

RING

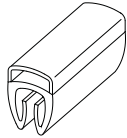

SNAP

Wire external diameter		Marker holder length		Marker holder	Compatible marker
mm	in	mm	in		
Slide-on cable marker holder					
Ø 1.5 ... 2.5	Ø 0.059 ... 0.098	12	0.472	RING122	WM 12
		18	0.709	RING182	WM 18
Ø 2 ... 4	Ø 0.079 ... 0.157	12	0.472	RING124	WM 12
		18	0.709	RING184	WM 18
Ø 4 ... 7	Ø 0.157 ... 0.276	12	0.472	RING127	WM 12
		18	0.709	RING187	WM 18
Ø 6 ... 10	Ø 0.236 ... 0.394	12	0.472	RING1210	WM 12
		18	0.709	RING1810	WM 18
Clip-on cable marker holder					
Ø 2 ... 3.5	Ø 0.079 ... 0.138	15	0.591	SNAP152	WM 12
		23	0.906	SNAP232	WM 18
Ø 2.8 ... 5	Ø 0.11 ... 0.197	15	0.591	SNAP154	WM 12
		23	0.906	SNAP234	WM 18
Ø 5 ... 8	Ø 0.197 ... 0.315	15	0.591	SNAP157	WM 12
		23	0.906	SNAP237	WM 18
Ø 8 ... 10	Ø 0.315 ... 0.394	15	0.591	SNAP1510	WM 12
		23	0.906	SNAP2310	WM 18

For identification of thick tubes

Tie-on markers / marker holders

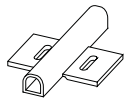

RINGT23

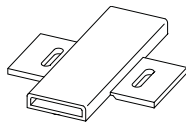

RINGT209

Marker holder length		Marker holder	Compatible marker
mm	in		
23	23	RINGT23	WM 18
28	28	RINGT209	PCGS209

WM wire and cable markers

Slide-in precut blank labels



1SNC70018R0000

WM12

Description

- Blank marker card for wire and cable identification,
- Markers are protected in the marker holders,
- To be slid into RING or SNAP transparent holders,
- Made of ABS.

Main technical data

Material	Flammability	Temperature range
Acrylonitrile Butadienne Styrene (ABS)	V0	-50°C to +80°C -58°F to +176°F

Ordering details

Dimensions		Maximum printed digits		Nb. of markers per card	Color	Type	Part Number	Pkg card	Weight (1 card) g
mm	in	Hor.	Vert.						

WM12

For 12 mm 0.472 in RING or SNAP holders

12 x 4	0.472 x 0.157	2	8	60	White <input type="checkbox"/>	WM12	1SNA235148R0700	50	12.00
--------	---------------	---	---	----	--------------------------------	------	-----------------	----	-------

WM18

For 18 mm 0.709 in RING or SNAP holders

18 x 4	0.709 x 0.157	2	10	60	White <input type="checkbox"/>	WM18	1SNA235149R0000	50	15.00
--------	---------------	---	----	----	--------------------------------	------	-----------------	----	-------

Marking system accessories

SPRC 26

Support plate for AMS600 and AMS250

Purchased separately						SPRC 26	1SNA360036R0300	1	300.00
----------------------	--	--	--	--	--	---------	-----------------	---	--------



Compatible holders



RING
Sealed transparent holder



SNAP
Unsealed transparent holder



RINGT23
Tie-on sealed transparent holder

RING, SNAP transparent marker holders

For WM markers



1SNC160251F0014

Description

- Transparent marker holder profiled to allow marking on various cable sizes, up to \varnothing 10 mm 0.394 in,
- Use with WM and WMTT markers,
- Made of PVC.

Main technical data

Material	Flammability	Temperature range
PVC	V0	-50°C to +80°C -58°F to +176°F

Ordering details

Wire ext. diameter		Wire section mm ²	Holder length		Color	Type	Part Number	Pkg pce	Weight (1 pce) g
mm	in		mm	in					

For cable mounting

RING



RING

12 mm 0.472 in sealed transparent holder for WM12 and WMTT12 markers

1.5 ... 2.5	0.059 ... 0.098		12	0.472	Transparent	<input checked="" type="checkbox"/>	RING122	1SNA235117R1000	3000	1.80
2 ... 4	0.079 ... 0.157				Transparent	<input checked="" type="checkbox"/>	RING124	1SNA235118R2100	3000	2.20
4 ... 7	0.157 ... 0.276				Transparent	<input checked="" type="checkbox"/>	RING127	1SNA235119R2200	2000	0.30
6 ... 10	0.236 ... 0.394				Transparent	<input checked="" type="checkbox"/>	RING1210	1SNA235120R2700	2000	0.50

18 mm 0.709 in sealed transparent holder for WM18 and WMTT18 markers

1.5 ... 2.5	0.059 ... 0.098		18	0.709	Transparent	<input checked="" type="checkbox"/>	RING182	1SNA235123R1600	3000	0.30
2 ... 4	0.079 ... 0.157				Transparent	<input checked="" type="checkbox"/>	RING184	1SNA235124R1700	3000	0.30
4 ... 7	0.157 ... 0.276				Transparent	<input checked="" type="checkbox"/>	RING187	1SNA235125R1000	2000	0.50
6 ... 10	0.236 ... 0.394				Transparent	<input checked="" type="checkbox"/>	RING1810	1SNA235126R1100	1000	0.70

SNAP



SNAP

12 mm 0.472 in un-sealed transparent holder for WM12 and WMTT12 markers

2 ... 3.5	0.079 ... 0.138		15	0.591	Transparent	<input checked="" type="checkbox"/>	SNAP152	1SNA235129R2400	1000	0.40
2.8 ... 5	0.110 ... 0.197				Transparent	<input checked="" type="checkbox"/>	SNAP154	1SNA235130R2100	1000	0.40
5 ... 8	0.197 ... 0.315				Transparent	<input checked="" type="checkbox"/>	SNAP157	1SNA235131R1600	500	0.50
8 ... 10	0.315 ... 0.394				Transparent	<input checked="" type="checkbox"/>	SNAP1510	1SNA235132R1700	500	1.40

23 mm 0.906 in un-sealed transparent holder for WM18 and WMTT18 markers

2 ... 3.5	0.079 ... 0.138		23	0.906	Transparent	<input checked="" type="checkbox"/>	SNAP232	1SNA235133R1000	500	0.40
2.8 ... 5	0.110 ... 0.197				Transparent	<input checked="" type="checkbox"/>	SNAP234	1SNA235134R1100	500	0.60
5 ... 8	0.197 ... 0.315				Transparent	<input checked="" type="checkbox"/>	SNAP237	1SNA235135R1200	200	0.90
8 ... 10	0.315 ... 0.394				Transparent	<input checked="" type="checkbox"/>	SNAP2310	1SNA235136R1300	200	2.20

For thick tube mounting

RINGT23



RINGT23

23 mm 0.906 in tie-on sealed transparent holder for WM and WMTT markers

			23	0.906	Transparent	<input checked="" type="checkbox"/>	RINGT23	1SNA235137R1400	200	0.40
--	--	--	----	-------	-------------	-------------------------------------	---------	-----------------	-----	------

Use holders only with designated cable marker of the same or a shorter length.

4

1SNC160137S0201

PCGS wire and cable markers

Slide-in precut blank labels

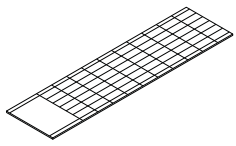

PCGS209

1SNC700181P0000

Description

- Blank marker card for thick wires,
- To be inserted in RINGT209 holder,
- Made of PVC.

Main technical data

Material	Flammability	Temperature range
PVC	V0	-40°C to +60°C -40°F to +140°F

Ordering details

Dimensions	Nb. of markers per card	Color	Type	Part Number	Pkg	Weight
mm in					card	(1 card) g

PCGS

For RINGT holders

20 x 9.3	0.787 x 0.366	60	White <input type="checkbox"/>	PCGS209	1SNA235150R0500	40	10.00
----------	---------------	----	--------------------------------	---------	-----------------	----	-------



Marking system accessories

SPRC 21

Support plate for AMS600 and AMS250

Purchased separately				SPRC 21	1SNA360031R0600	1	500.00
----------------------	--	--	--	---------	-----------------	---	--------

Use holders only with designated cable marker of the same or a shorter length.

RINGT209 transparent marker holders

For PCGS markers



RINGT209

1SNC16010P0014

Description

- Transparent tie-on marker holders profiled to allow thick tube identification,
- Use with PCGS209 markers,
- Made of PVC.

Main technical data

Material	Flammability	Temperature range
PVC	V0	-50°C to +80°C -58°F to +176°F

Ordering details

Dimensions	Color	Type	Part Number	Pkg	Weight
mm in				pce	(1 pce) g

For thick tube mounting

RINGT209

Tie-on sealed transparent holder for PCGS markers

9,5 x 20	0.374 x 0.787	Transparent <input checked="" type="checkbox"/>	RINGT209	1SNA235142R2100	240	6.00
----------	---------------	---	----------	-----------------	-----	------

Use holders only with designated cable marker of the same or a shorter length.
Dimensions given apply to the labelling area.

1SNC16012IS0201



RCCV wire and cable markers

Slide-in blank label

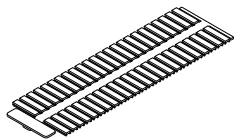

RCCV

1SNCT0027F0000

Description

- Blank marker card for wire and cable identification,
- Markers are protected in the marker holders,
- To be slided in PETC transparent holder,
- Made of halogen-free PVC.

Main technical data

Material	Flammability	Temperature range
PVC	V0	-20°C to +60°C -4°F to +140°F

Ordering details

Dimensions		Maximum printed digits		Nb. of markers per card	Color	Type	Part Number	Pkg	Weight
mm	in	Hor.	Vert.						

Card of 48 blank markers compatible with PETC holders

4.2 x 16.5	0.165 x 0.650		48	White	<input type="checkbox"/> RCCV	1SNA235460R0400	1	10.00
------------	---------------	--	----	-------	-------------------------------	-----------------	---	-------

Marking system accessories

SPRCC 2

Support plate for AMS600

Purchased separately						SPRCC 2	1SNA360011R0200	1	330.00
----------------------	--	--	--	--	--	---------	-----------------	---	--------

Mounting instruction

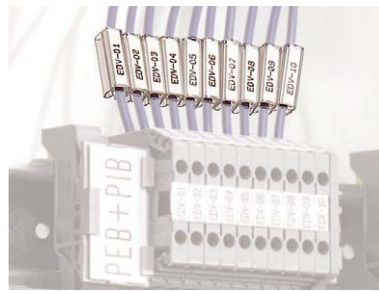

PETC transparent marker holders

For RCCV makers



1SNCT60251F0014

Description

- Transparent marker holder for wire and cable identification,
- To be used with RCCV markers,
- Made of PVC.

Main technical data

Material	Flammability	Temperature range
PVC		-20°C to +90°C -4°F to +194°F

Ordering details

Wire ext. diameter		Wire section mm ²	Holder length		Color	Type	Part Number	Pkg	Weight
mm	in		mm	in					
1.1 ... 3.3	0.043 ... 0.130	0.1 ... 1	18	0.709	Transparent	<input checked="" type="checkbox"/> PETC 51	1SNA168737R0200	100	
1.5 ... 4.5	0.059 ... 0.177	1 ... 2.5			Transparent	<input checked="" type="checkbox"/> PETC 53	1SNA168741R1600	100	
3 ... 8	0.118 ... 0.315	2.5 ... 10			Transparent	<input checked="" type="checkbox"/> PETC 56	1SNA168747R1400	100	

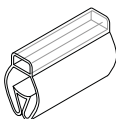

1SNCT60134S0201

RPA, PIB2 component and equipment markers

Self-adhesive precut blank labels

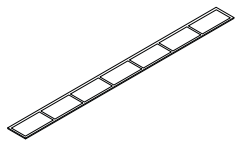

1SNC700241F000

PIB2

Description

- Self-adhesive precut blank labels for general purpose,
- High performance adhesive compatible with most surface types.

Main technical data

Material	Flammability
PVC	

Ordering details

Dimensions		Nb. of markers per card	Color	Type	Part Number	Pkg card	Weight (1 card) g
mm	in						
RPA							
8 x 17.5	0.315 x 0.689	16	White <input type="checkbox"/>	RPA	1SNA235463R2300	50	0.20
PIB2							
35 x 17.5	1.378 x 0.689	7	White <input type="checkbox"/>	PIB2	1SNA235461R2100	50	0.60



Marking system accessories

SPRC 13

Support plate for AMS600 and AMS250

Purchased separately		SPRC 13	1SNA360023R0600	1	260.00
----------------------	--	---------	-----------------	---	--------



Mounting instruction

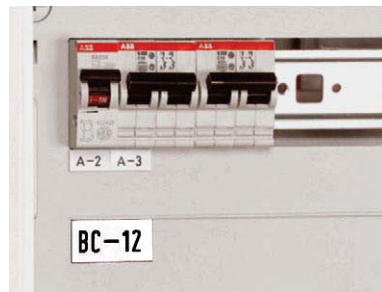

1SNC160126S0201



PSP component and equipment markers

Self-adhesive precut blank labels

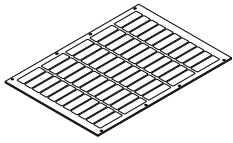

1SNC700198F000

PSP

Description

- Self-adhesive blank precut markers with round shaped edges,
- Can be used as plate for sub-assembly identification,
- Double-layered, can be engraved (black layer underneath).

Main technical data

Material	Flammability	Temperature range
MMA	UB	-40°C to +82°C -40°F to +180°F

Ordering details

Dimensions		Nb. of markers per card	Color	Type	Part Number	Pkg	Weight
mm	in						
15 x 50	0.591 x 1.969	55	White <input type="checkbox"/>	PSP5015	1SNA235109R0100	2	10.00



Marking system accessories

SPRC 21

Support plate for AMS600 and AMS250

Purchased separately	SPRC 21	1SNA360031R0600	1	500.00
----------------------	---------	-----------------	---	--------

Compatible holders

PCT100015

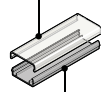

PAM100015

Protective cover and self-adhesive marking profile

PAM component and equipment markers

Self-adhesive precut blank labels

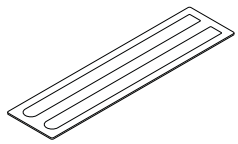

1SNCT00197F0000

PAM

Description

- Self-adhesive blank labels used to identified different components and equipments in a cabinet,
- Can be used directly on equipment.

Main technical data

Material	Flammability	Temperature range
PVC	V0	-40°C to +60°C -40°F to +140°F

Ordering details

Dimensions		Nb. of markers per card	Color	Type	Part Number	Pkg card	Weight (1 card) g
mm	in						

PAM

Self-adhesive blank label compatible with PAM100015 and PCT100015 transparent cover

15 x 215	0.591 x 8.465	2	White <input type="checkbox"/>	PAM21515	1SNA235103R2300	20	12.00
15 x 430	0.591 x 16.930		White <input type="checkbox"/>	PAM43015	1SNA235104R2400	20	22.00

Self-adhesive blank label

20 x 215	0.787 x 8.465	2	White <input type="checkbox"/>	PAM21520	1SNA235105R2500	20	14.00
20 x 430	0.787 x 16.930		White <input type="checkbox"/>	PAM43020	1SNA235106R2600	20	27.00

Marking system accessories

SPRC 27

Support plate for AMS600

Purchased separately		SPRC 27	1SNA360037R0400	1	300.00
----------------------	--	---------	-----------------	---	--------



Compatible holders

PCT100015

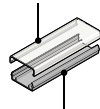

PAM100015

Protective cover and self-adhesive marking profile

(only for PAM21515 and PAM43015)

1SNCT00130S0201



BA4 component and equipment markers

Precut blank label



1SNC16010F0014

Description

- Precut blank label used to identify contactors, overload relays and manual motor starters,
- Compatible with: AF09 ... AF370 contactors, TF thermal overload relays, EF electronic overload relays, and MS116, MS132 manual motor starters.

Main technical data

Material	Flammability
Polycarbonate	V0

Ordering details

Dimensions	Color	Type	Part Number	Pkg	Weight
mm in				card	(1 card) g

BA4

Card of 16 blank labels



7 x 20	0.276 x 0.787	White <input type="checkbox"/>	BA4	1SNA235156R2700	16	11.00
--------	---------------	--------------------------------	-----	-----------------	----	-------

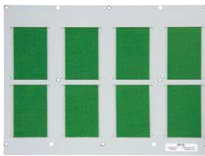

Marking system accessories

SPRC 1

Support plate for AMS600

Included in KIT MAO AMS 600		SPRC 1	1SNA360010R1500	1	1500.00
-----------------------------	--	--------	-----------------	---	---------

Mounting instruction



PPB component and equipment markers

Two-colored precut blank labels

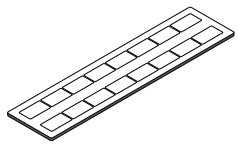

1SNC1002001R0000

PPB

Description

- Two-colored blank label cards, white side / black side,
- For push button or sub-assembly identification,
- To be used with a label holder.

Main technical data

Material	Flammability	Temperature range
MMA	HB	-40°C to +82°C -40°F to +180°F

Ordering details

Dimensions		Nb. of markers per card	Color	Type	Part Number	Pkg card	Weight (1 card) g
mm	in						
15 x 27	0.591 x 1.063	16	White and Black	PPB2715	1SNA235111R1200	12	13.30



Marking system accessories

SPRC 21

Support plate for AMS600 and AMS250

Purchased separately	SPRC 21	1SNA360031R0600	1	500.00
----------------------	---------	-----------------	---	--------

Compatible holders

PCT100015

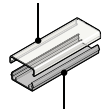

PAM100015

Protective cover and self-adhesive marking profile



KA1-8120

Push button marker holder

1SNC160132S0201

PAM100015, PCT, KA marker holders

For component and equipment markers



1SNC160288FC014

Description

- Self-adhesive marking profile (PAM), transparent cover (PCT) and push-button marker holder (KA1),
- To be used with PAM21515, PAM43015, PSP and PPB labels.

Main technical data

Material	Flammability	Temperature range
PVC (for PAM and PCT)	V0 (for PAM and PCT)	-10°C to +70°C +14°F to +158°F (for PAM and PCT)
Polycarbonate (for KA1)	V2 (for KA1)	-25°C to +70°C -13°F to +158°F (for KA1)

Ordering details

Dimensions	Color	Type	Part Number	Pkg	Weight
mm	in			pce	(1 pce) g



KA1-8120

Push-button marker holder

KA1

Push button marker holder for PPB markers.

15 x 27	0.591 x 1.063	Black ■	KA1-8120	1SFA616920R8120	10	2.00
---------	---------------	---------	----------	-----------------	----	------

Self-adhesive marking profile for PAM, PSP and PPB markers.

PCT

Transparent cover for PAM100015

15 x 1000	0.591 x 39.370	Transparent ☑	PCT100015	1SNA235147R2600	35	34.00
-----------	----------------	---------------	-----------	-----------------	----	-------

PAM100015

Self-adhesive marking profile for PAM, PSP and PPB markers.

15 x 1000	0.591 x 39.370	Black ■	PAM100015	1SNA235146R2500	35	40.00
-----------	----------------	---------	-----------	-----------------	----	-------

Dimensions given apply to the labelling area.

PCT100015

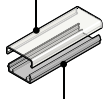

PAM100015

PAT panel plates

Self-adhesive blank panel plates

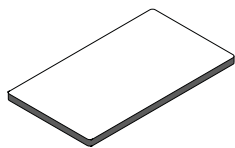

PAT

1SNCT00214FP000

Description

- Self-adhesive blank plate for identification of electrical boxes or cabinets.

Main technical data

Material	Flammability	Temperature range
PVC	V0	-40°C to +120°C -40°F to +248°F

Ordering details

Dimensions	Nb. of markers per card	Color	Type	Part Number	Pkg	Weight
mm : in					pce	(1 pce) g

PAT

Adhesive plate for external marking

60 x 100	2.262 x 3.937	1	White <input type="checkbox"/>	PAT10060	1SNA235114R1500	15	5.30
----------	---------------	---	--------------------------------	----------	-----------------	----	------



Marking system accessories

SPRC 21

Support plate for AMS600 and AMS250

Purchased separately				SPRC 21	1SNA360031R0600	1	500.00
----------------------	--	--	--	---------	-----------------	---	--------

PPT panel plates

Blank panel plates

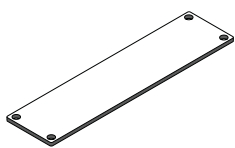

PPT

1SNCT00213FP000

Description

- Blank perforated plate for identification of electrical boxes or cabinets,
- To be fixed with rivets.

Main technical data

Material	Flammability	Temperature range
MMA	HB	-40°C to +82°C -40°F to +180°F

Ordering details

Dimensions	Nb. of markers per card	Color	Type	Part Number	Pkg	Weight
mm : in					pce	(1 pce) g

PPT

Perforated blank plate

30 x 120	1.181 x 4.724	1	White <input type="checkbox"/>	PPT12030	1SNA235115R1600	50	3.50
50 x 180	1.969 x 7.087		White <input type="checkbox"/>	PPT18050	1SNA235116R1700	30	8.80



Marking system accessories

SPRC 21

Support plate for AMS600 and AMS250

Purchased separately				SPRC 21	1SNA360031R0600	1	500.00
----------------------	--	--	--	---------	-----------------	---	--------

Mounting instruction

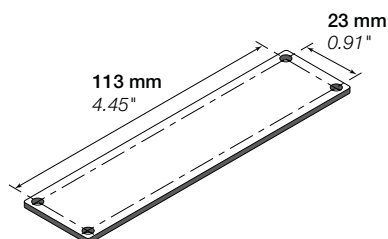

1SNCT160136S0201



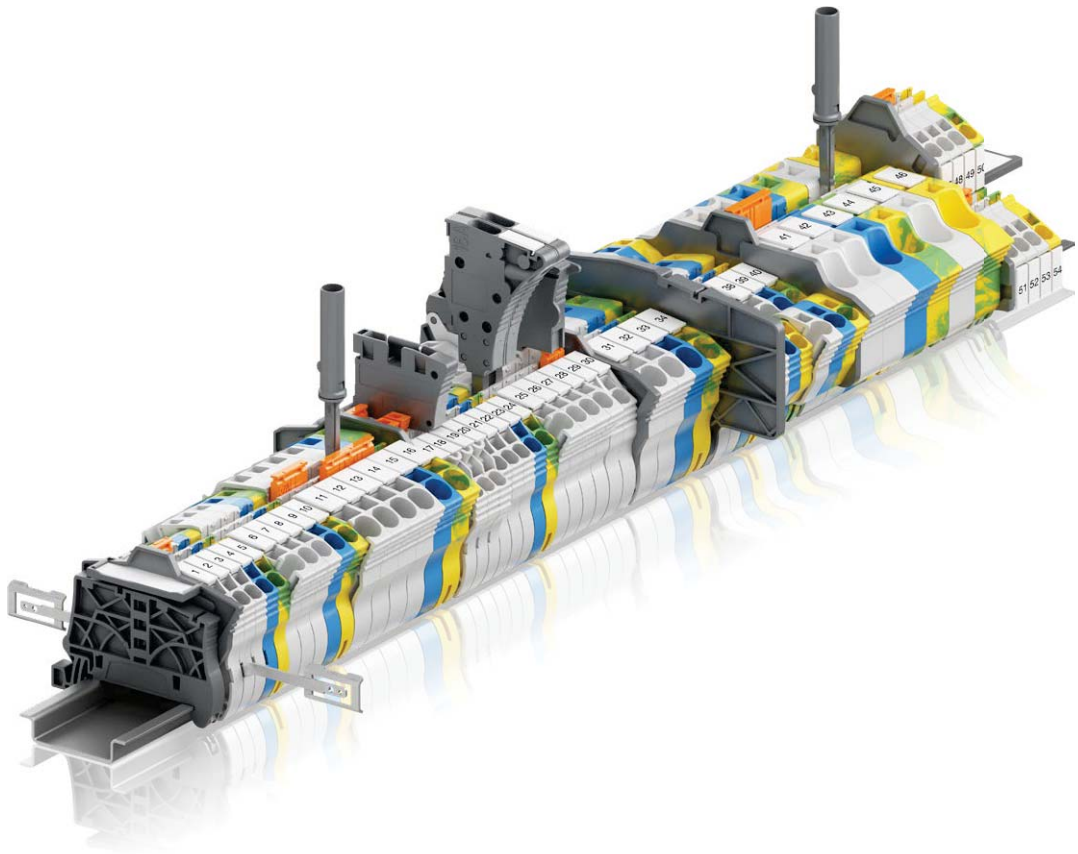

Solution series

Pre-printed markers

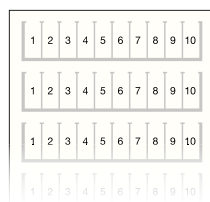

SNK series terminal block identification

5.2 mm <i>0.205 in</i> spacing	MC512PA	horizontal mounting	112
		vertical mounting	114
6 mm <i>0.236 in</i> spacing	MC612PA	horizontal mounting	116
		vertical mounting	118
8 mm <i>0.315 in</i> spacing	MC812PA	horizontal mounting	120
		vertical mounting	122



SNA series terminal block identification

4 mm <i>0.157 in</i> spacing	RC410	horizontal mounting	124
		vertical mounting	126
5 mm <i>0.197 in</i> spacing	RC510	horizontal mounting	128
		vertical mounting	130
6 mm <i>0.236 in</i> spacing	RC610	horizontal mounting	132
		vertical mounting	135
8 mm <i>0.315 in</i> spacing	RC810	horizontal mounting	137
		vertical mounting	139
10 mm <i>0.394 in</i> spacing	RC1010	horizontal mounting	140
		vertical mounting	141



Specific terminal block identification

5 mm <i>0.197 in</i> spacing	RC55	horizontal mounting	142
		vertical mounting	144
6 mm <i>0.236 in</i> spacing	RC65	horizontal mounting	145
		vertical mounting	147
8 mm <i>0.315 in</i> spacing	RCAL85	horizontal mounting	149
		vertical mounting	150
6 mm <i>0.236 in</i> spacing	RCT		151
6 mm <i>0.236 in</i> to 12 mm <i>0.472 in</i> spacing	RTM	top marking	152
13 mm <i>0.512 in</i> or 16 mm <i>0.630 in</i> spacing	REH3		153
5 mm <i>0.197 in</i> to 12 mm <i>0.472 in</i> spacing	EPU	top marking	154
6 mm <i>0.236 in</i> to 22 mm <i>0.866 in</i> spacing	EP	top marking	155

Customized marking

Order form			156
------------	--	--	-----

MC512PA terminal block markers

Pre-printed markers for SNK series - 5.2 mm 0.205 in spacing - horizontal mounting



Horizontal terminal block assembly

Description

- Save printing time with our large pre-printed card offer with pre-printed numbers, letters or symbols.

Main technical data

Material	Flammability
Polyamide	V2

Ordering details

Description	Color	Type	Part Number	Pkg card	Weight (1 card) g
-------------	-------	------	-------------	----------	-------------------

Card with 100 markers, ascending order repeated 10 times

0->9 (x10)	White	<input type="checkbox"/>	MC512PA	1SNK140091R0000	5	10.00
1->10 (x10)	White	<input type="checkbox"/>	MC512PA	1SNK140011R0000	5	10.00
11->20 (x10)	White	<input type="checkbox"/>	MC512PA	1SNK140021R0000	5	10.00
21->30 (x10)	White	<input type="checkbox"/>	MC512PA	1SNK140031R0000	5	10.00
31->40 (x10)	White	<input type="checkbox"/>	MC512PA	1SNK140041R0000	5	10.00
41->50 (x10)	White	<input type="checkbox"/>	MC512PA	1SNK140051R0000	5	10.00
51->60 (x10)	White	<input type="checkbox"/>	MC512PA	1SNK140061R0000	5	10.00
61->70 (x10)	White	<input type="checkbox"/>	MC512PA	1SNK140071R0000	5	10.00
71->80 (x10)	White	<input type="checkbox"/>	MC512PA	1SNK140081R0000	5	10.00
81->90 (x10)	White	<input type="checkbox"/>	MC512PA	1SNK140083R0000	5	10.00
91->100 (x10)	White	<input type="checkbox"/>	MC512PA	1SNK140101R0000	5	10.00
101->110 (x10)	White	<input type="checkbox"/>	MC512PA	1SNK140111R0000	5	10.00
111->120 (x10)	White	<input type="checkbox"/>	MC512PA	1SNK140121R0000	5	10.00
121->130 (x10)	White	<input type="checkbox"/>	MC512PA	1SNK140131R0000	5	10.00
131->140 (x10)	White	<input type="checkbox"/>	MC512PA	1SNK140141R0000	5	10.00
141->150 (x10)	White	<input type="checkbox"/>	MC512PA	1SNK140151R0000	5	10.00
151->160 (x10)	White	<input type="checkbox"/>	MC512PA	1SNK140161R0000	5	10.00
161->170 (x10)	White	<input type="checkbox"/>	MC512PA	1SNK140171R0000	5	10.00
171->180 (x10)	White	<input type="checkbox"/>	MC512PA	1SNK140181R0000	5	10.00
181->190 (x10)	White	<input type="checkbox"/>	MC512PA	1SNK140191R0000	5	10.00
191->200 (x10)	White	<input type="checkbox"/>	MC512PA	1SNK140201R0000	5	10.00

Card with 100 markers, ascending order

1->100	White	<input type="checkbox"/>	MC512PA	1SNK145011R0000	5	10.00
101->200	White	<input type="checkbox"/>	MC512PA	1SNK145021R0000	5	10.00
201->300	White	<input type="checkbox"/>	MC512PA	1SNK145031R0000	5	10.00
301->400	White	<input type="checkbox"/>	MC512PA	1SNK145041R0000	5	10.00
401->500	White	<input type="checkbox"/>	MC512PA	1SNK145051R0000	5	10.00
501->600	White	<input type="checkbox"/>	MC512PA	1SNK145061R0000	5	10.00
601->700	White	<input type="checkbox"/>	MC512PA	1SNK145071R0000	5	10.00
701->800	White	<input type="checkbox"/>	MC512PA	1SNK145081R0000	5	10.00
801->900	White	<input type="checkbox"/>	MC512PA	1SNK145091R0000	5	10.00

Card with 100 markers, repeated identical numbers

0 (x100)	White	<input type="checkbox"/>	MC512PA	1SNK147001R0000	5	10.00
1 (x100)	White	<input type="checkbox"/>	MC512PA	1SNK147011R0000	5	10.00
2 (x100)	White	<input type="checkbox"/>	MC512PA	1SNK147021R0000	5	10.00
3 (x100)	White	<input type="checkbox"/>	MC512PA	1SNK147031R0000	5	10.00
4 (x100)	White	<input type="checkbox"/>	MC512PA	1SNK147041R0000	5	10.00
5 (x100)	White	<input type="checkbox"/>	MC512PA	1SNK147051R0000	5	10.00
6 (x100)	White	<input type="checkbox"/>	MC512PA	1SNK147061R0000	5	10.00
7 (x100)	White	<input type="checkbox"/>	MC512PA	1SNK147071R0000	5	10.00
8 (x100)	White	<input type="checkbox"/>	MC512PA	1SNK147081R0000	5	10.00
9 (x100)	White	<input type="checkbox"/>	MC512PA	1SNK147091R0000	5	10.00

Continue on next page →

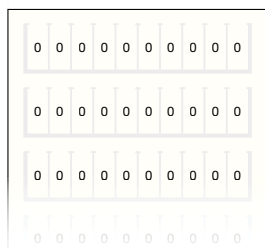
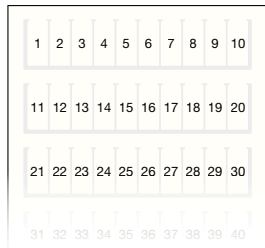
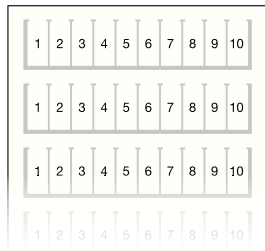

MC512PA terminal block markers

Pre-printed markers for SNK series - 5.2 mm 0.205 in spacing - horizontal mounting

Ordering details

Description	Color	Type	Part Number	Pkg card	Weight (1 card) g
-------------	-------	------	-------------	----------	-------------------

← Continuation of previous page

Card with 100 markers, repeated identical letters

A (x100)	White	MC512PA	1SNK146011R0000	5	10.00
B (x100)	White	MC512PA	1SNK146021R0000	5	10.00
C (x100)	White	MC512PA	1SNK146031R0000	5	10.00
D (x100)	White	MC512PA	1SNK146041R0000	5	10.00
E (x100)	White	MC512PA	1SNK146051R0000	5	10.00
F (x100)	White	MC512PA	1SNK146061R0000	5	10.00
G (x100)	White	MC512PA	1SNK146071R0000	5	10.00
H (x100)	White	MC512PA	1SNK146081R0000	5	10.00
I (x100)	White	MC512PA	1SNK146091R0000	5	10.00
J (x100)	White	MC512PA	1SNK146101R0000	5	10.00
K (x100)	White	MC512PA	1SNK146111R0000	5	10.00
L (x100)	White	MC512PA	1SNK146121R0000	5	10.00
M (x100)	White	MC512PA	1SNK146131R0000	5	10.00
N (x100)	White	MC512PA	1SNK146141R0000	5	10.00
O (x100)	White	MC512PA	1SNK146151R0000	5	10.00
P (x100)	White	MC512PA	1SNK146161R0000	5	10.00
Q (x100)	White	MC512PA	1SNK146171R0000	5	10.00
R (x100)	White	MC512PA	1SNK146181R0000	5	10.00
S (x100)	White	MC512PA	1SNK146191R0000	5	10.00
T (x100)	White	MC512PA	1SNK146201R0000	5	10.00
U (x100)	White	MC512PA	1SNK146211R0000	5	10.00
V (x100)	White	MC512PA	1SNK146221R0000	5	10.00
W (x100)	White	MC512PA	1SNK146231R0000	5	10.00
X (x100)	White	MC512PA	1SNK146241R0000	5	10.00
Y (x100)	White	MC512PA	1SNK146251R0000	5	10.00
Z (x100)	White	MC512PA	1SNK146261R0000	5	10.00

Card with 100 markers, repeated identical symbols

+ (x100)	White	MC512PA	1SNK148001R0000	5	10.00
- (x100)	White	MC512PA	1SNK148011R0000	5	10.00
~ (x100)	White	MC512PA	1SNK148021R0000	5	10.00
= (x100)	White	MC512PA	1SNK148031R0000	5	10.00
± (x100)	White	MC512PA	1SNK148041R0000	5	10.00
L1 (x100)	White	MC512PA	1SNK148051R0000	5	10.00
L2 (x100)	White	MC512PA	1SNK148061R0000	5	10.00
L3 (x100)	White	MC512PA	1SNK148071R0000	5	10.00
PE (x100)	White	MC512PA	1SNK148091R0000	5	10.00
U1 (x100)	White	MC512PA	1SNK148101R0000	5	10.00
U2 (x100)	White	MC512PA	1SNK148111R0000	5	10.00
U3 (x100)	White	MC512PA	1SNK148121R0000	5	10.00
V1 (x100)	White	MC512PA	1SNK148131R0000	5	10.00
V2 (x100)	White	MC512PA	1SNK148141R0000	5	10.00
V3 (x100)	White	MC512PA	1SNK148151R0000	5	10.00
W1 (x100)	White	MC512PA	1SNK148161R0000	5	10.00
W2 (x100)	White	MC512PA	1SNK148171R0000	5	10.00
W3 (x100)	White	MC512PA	1SNK148181R0000	5	10.00

Card with 100 markers, 5 different symbols repeated 20 times

L1-L2-L3-N-PE (x20)	White	MC512PA	1SNK149001R0000	5	10.00
---------------------	-------	---------	-----------------	---	-------

Card with 100 markers, 9 different symbols repeated 10 times

U1-U2-U3-V1-V2-V3-W1-W2-W3 (x10) + U1 (x10)	White	MC512PA	1SNK149011R0000	5	10.00
---	-------	---------	-----------------	---	-------

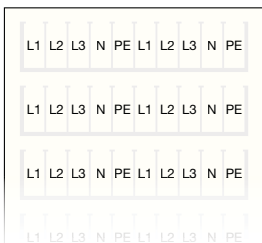
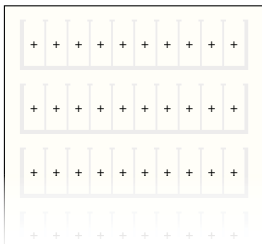
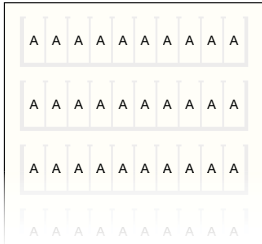

MC512PA terminal block markers

Pre-printed markers for SNK series

5.2 mm 0.205 in spacing - vertical mounting

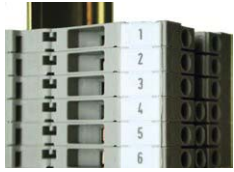

Vertical terminal block assembly

Description

– Save printing time with our large pre-printed card offer with pre-printed numbers, letters or symbols.

Main technical data

Material	Flammability
Polyamide	V2

Ordering details

Description	Color	Type	Part Number	Pkg card	Weight (1 card) g
Card with 100 markers, ascending order repeated 10 times					
0->9 (x10)	White <input type="checkbox"/>	MC512PA	1SNK140092R0000	5	10.00
1->10 (x10)	White <input type="checkbox"/>	MC512PA	1SNK140012R0000	5	10.00
11->20 (x10)	White <input type="checkbox"/>	MC512PA	1SNK140022R0000	5	10.00
21->30 (x10)	White <input type="checkbox"/>	MC512PA	1SNK140032R0000	5	10.00
31->40 (x10)	White <input type="checkbox"/>	MC512PA	1SNK140042R0000	5	10.00
41->50 (x10)	White <input type="checkbox"/>	MC512PA	1SNK140052R0000	5	10.00
51->60 (x10)	White <input type="checkbox"/>	MC512PA	1SNK140062R0000	5	10.00
61->70 (x10)	White <input type="checkbox"/>	MC512PA	1SNK140072R0000	5	10.00
71->80 (x10)	White <input type="checkbox"/>	MC512PA	1SNK140082R0000	5	10.00
81->90 (x10)	White <input type="checkbox"/>	MC512PA	1SNK140084R0000	5	10.00
91->100 (x10)	White <input type="checkbox"/>	MC512PA	1SNK140102R0000	5	10.00
101->110 (x10)	White <input type="checkbox"/>	MC512PA	1SNK140112R0000	5	10.00
111->120 (x10)	White <input type="checkbox"/>	MC512PA	1SNK140122R0000	5	10.00
121->130 (x10)	White <input type="checkbox"/>	MC512PA	1SNK140132R0000	5	10.00
131->140 (x10)	White <input type="checkbox"/>	MC512PA	1SNK140142R0000	5	10.00
141->150 (x10)	White <input type="checkbox"/>	MC512PA	1SNK140152R0000	5	10.00
151->160 (x10)	White <input type="checkbox"/>	MC512PA	1SNK140162R0000	5	10.00
161->170 (x10)	White <input type="checkbox"/>	MC512PA	1SNK140172R0000	5	10.00
171->180 (x10)	White <input type="checkbox"/>	MC512PA	1SNK140182R0000	5	10.00
181->190 (x10)	White <input type="checkbox"/>	MC512PA	1SNK140192R0000	5	10.00
191->200 (x10)	White <input type="checkbox"/>	MC512PA	1SNK140202R0000	5	10.00
Card with 100 markers, ascending order					
1->100	White <input type="checkbox"/>	MC512PA	1SNK145012R0000	5	10.00
101->200	White <input type="checkbox"/>	MC512PA	1SNK145022R0000	5	10.00
201->300	White <input type="checkbox"/>	MC512PA	1SNK145032R0000	5	10.00
301->400	White <input type="checkbox"/>	MC512PA	1SNK145042R0000	5	10.00
401->500	White <input type="checkbox"/>	MC512PA	1SNK145052R0000	5	10.00
501->600	White <input type="checkbox"/>	MC512PA	1SNK145062R0000	5	10.00
601->700	White <input type="checkbox"/>	MC512PA	1SNK145072R0000	5	10.00
701->800	White <input type="checkbox"/>	MC512PA	1SNK145082R0000	5	10.00
801->900	White <input type="checkbox"/>	MC512PA	1SNK145092R0000	5	10.00
901->1000	White <input type="checkbox"/>	MC512PA	1SNK145102R0000	5	10.00
Card with 100 markers, repeated identical numbers					
0 (x100)	White <input type="checkbox"/>	MC512PA	1SNK147002R0000	5	10.00
1 (x100)	White <input type="checkbox"/>	MC512PA	1SNK147012R0000	5	10.00
2 (x100)	White <input type="checkbox"/>	MC512PA	1SNK147022R0000	5	10.00
3 (x100)	White <input type="checkbox"/>	MC512PA	1SNK147032R0000	5	10.00
4 (x100)	White <input type="checkbox"/>	MC512PA	1SNK147042R0000	5	10.00
5 (x100)	White <input type="checkbox"/>	MC512PA	1SNK147052R0000	5	10.00
6 (x100)	White <input type="checkbox"/>	MC512PA	1SNK147062R0000	5	10.00
7 (x100)	White <input type="checkbox"/>	MC512PA	1SNK147072R0000	5	10.00
8 (x100)	White <input type="checkbox"/>	MC512PA	1SNK147082R0000	5	10.00
9 (x100)	White <input type="checkbox"/>	MC512PA	1SNK147092R0000	5	10.00
Card with 100 markers, repeated identical letters					
A (x100)	White <input type="checkbox"/>	MC512PA	1SNK146012R0000	5	10.00
B (x100)	White <input type="checkbox"/>	MC512PA	1SNK146022R0000	5	10.00
C (x100)	White <input type="checkbox"/>	MC512PA	1SNK146032R0000	5	10.00
D (x100)	White <input type="checkbox"/>	MC512PA	1SNK146042R0000	5	10.00
E (x100)	White <input type="checkbox"/>	MC512PA	1SNK146052R0000	5	10.00
F (x100)	White <input type="checkbox"/>	MC512PA	1SNK146062R0000	5	10.00
G (x100)	White <input type="checkbox"/>	MC512PA	1SNK146072R0000	5	10.00
H (x100)	White <input type="checkbox"/>	MC512PA	1SNK146082R0000	5	10.00
I (x100)	White <input type="checkbox"/>	MC512PA	1SNK146092R0000	5	10.00
J (x100)	White <input type="checkbox"/>	MC512PA	1SNK146102R0000	5	10.00

Continue on next page →

MC512PA terminal block markers

Pre-printed markers for SNK series

5.2 mm 0.205 in spacing - vertical mounting

Ordering details

Description	Color	Type	Part Number	Pkg card	Weight (1 card) g
← Continuation of previous page					
K (x100)	White	□ MC512PA	1SNK146112R0000	5	10.00
L (x100)	White	□ MC512PA	1SNK146122R0000	5	10.00
M (x100)	White	□ MC512PA	1SNK146132R0000	5	10.00
N (x100)	White	□ MC512PA	1SNK146142R0000	5	10.00
O (x100)	White	□ MC512PA	1SNK146152R0000	5	10.00
P (x100)	White	□ MC512PA	1SNK146162R0000	5	10.00
Q (x100)	White	□ MC512PA	1SNK146172R0000	5	10.00
R (x100)	White	□ MC512PA	1SNK146182R0000	5	10.00
S (x100)	White	□ MC512PA	1SNK146192R0000	5	10.00
T (x100)	White	□ MC512PA	1SNK146202R0000	5	10.00
U (x100)	White	□ MC512PA	1SNK146212R0000	5	10.00
V (x100)	White	□ MC512PA	1SNK146222R0000	5	10.00
W (x100)	White	□ MC512PA	1SNK146232R0000	5	10.00
X (x100)	White	□ MC512PA	1SNK146242R0000	5	10.00
Y (x100)	White	□ MC512PA	1SNK146252R0000	5	10.00
Z (x100)	White	□ MC512PA	1SNK146262R0000	5	10.00

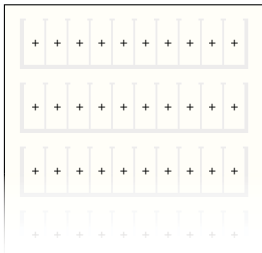

Card with 100 markers, repeated identical symbols

+ (x100)	White	□ MC512PA	1SNK148002R0000	5	10.00
- (x100)	White	□ MC512PA	1SNK148012R0000	5	10.00
~ (x100)	White	□ MC512PA	1SNK148022R0000	5	10.00
= (x100)	White	□ MC512PA	1SNK148032R0000	5	10.00
± (x100)	White	□ MC512PA	1SNK148042R0000	5	10.00
L1 (x100)	White	□ MC512PA	1SNK148052R0000	5	10.00
L2 (x100)	White	□ MC512PA	1SNK148062R0000	5	10.00
L3 (x100)	White	□ MC512PA	1SNK148072R0000	5	10.00
PE (x100)	White	□ MC512PA	1SNK148092R0000	5	10.00
U1 (x100)	White	□ MC512PA	1SNK148102R0000	5	10.00
U2 (x100)	White	□ MC512PA	1SNK148112R0000	5	10.00
U3 (x100)	White	□ MC512PA	1SNK148122R0000	5	10.00
V1 (x100)	White	□ MC512PA	1SNK148132R0000	5	10.00
V2 (x100)	White	□ MC512PA	1SNK148142R0000	5	10.00
V3 (x100)	White	□ MC512PA	1SNK148152R0000	5	10.00
W1 (x100)	White	□ MC512PA	1SNK148162R0000	5	10.00
W2 (x100)	White	□ MC512PA	1SNK148172R0000	5	10.00
W3 (x100)	White	□ MC512PA	1SNK148182R0000	5	10.00
+24V (x100)	White	□ MC512PA	1SNK148192R0000	5	10.00
+48V (x100)	White	□ MC512PA	1SNK148202R0000	5	10.00
-24V (x100)	White	□ MC512PA	1SNK148212R0000	5	10.00
-48V (x100)	White	□ MC512PA	1SNK148222R0000	5	10.00

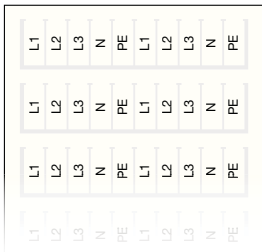

Card with 100 markers, 5 different symbols repeated 20 times

L1-L2-L3-N-PE (x20)	White	□ MC512PA	1SNK149002R0000	5	10.00
---------------------	-------	-----------	-----------------	---	-------

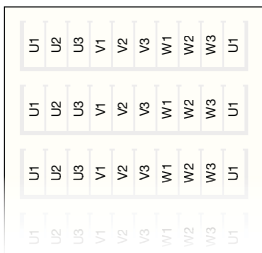

Card with 100 markers, 9 different symbols repeated 10 times

U1-U2-U3-V1-V2-V3-W1-W2-W3 (x10) + U1 (x10)	White	□ MC512PA	1SNK149012R0000	5	10.00
---	-------	-----------	-----------------	---	-------

5

1SNK160160S0201

MC612PA terminal block markers

Pre-printed markers for SNK series

6 mm 0.236 in spacing - horizontal mounting

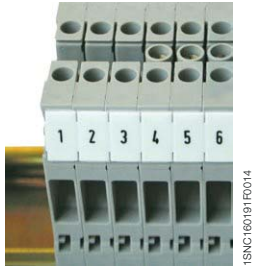

Horizontal terminal block assembly

Description

– Save printing time with our large pre-printed card offer with pre-printed numbers, letters or symbols.

Main technical data

Material	Flammability
Polyamide	V2

Ordering details

Description	Color	Type	Part Number	Pkg card	Weight (1 card) g
Card with 100 markers, ascending order repeated 10 times					
0->9 (x10)	White <input type="checkbox"/>	MC612PA	1SNK150091R0000	5	11.00
1->10 (x10)	White <input type="checkbox"/>	MC612PA	1SNK150011R0000	5	11.00
11->20 (x10)	White <input type="checkbox"/>	MC612PA	1SNK150021R0000	5	11.00
21->30 (x10)	White <input type="checkbox"/>	MC612PA	1SNK150031R0000	5	11.00
31->40 (x10)	White <input type="checkbox"/>	MC612PA	1SNK150041R0000	5	11.00
41->50 (x10)	White <input type="checkbox"/>	MC612PA	1SNK150051R0000	5	11.00
51->60 (x10)	White <input type="checkbox"/>	MC612PA	1SNK150061R0000	5	11.00
61->70 (x10)	White <input type="checkbox"/>	MC612PA	1SNK150071R0000	5	11.00
71->80 (x10)	White <input type="checkbox"/>	MC612PA	1SNK150081R0000	5	11.00
81->90 (x10)	White <input type="checkbox"/>	MC612PA	1SNK150083R0000	5	11.00
91->100 (x10)	White <input type="checkbox"/>	MC612PA	1SNK150101R0000	5	11.00
101->110 (x10)	White <input type="checkbox"/>	MC612PA	1SNK150111R0000	5	11.00
111->120 (x10)	White <input type="checkbox"/>	MC612PA	1SNK150121R0000	5	11.00
121->130 (x10)	White <input type="checkbox"/>	MC612PA	1SNK150131R0000	5	11.00
131->140 (x10)	White <input type="checkbox"/>	MC612PA	1SNK150141R0000	5	11.00
141->150 (x10)	White <input type="checkbox"/>	MC612PA	1SNK150151R0000	5	11.00
151->160 (x10)	White <input type="checkbox"/>	MC612PA	1SNK150161R0000	5	11.00
161->170 (x10)	White <input type="checkbox"/>	MC612PA	1SNK150171R0000	5	11.00
171->180 (x10)	White <input type="checkbox"/>	MC612PA	1SNK150181R0000	5	11.00
181->190 (x10)	White <input type="checkbox"/>	MC612PA	1SNK150191R0000	5	11.00
191->200 (x10)	White <input type="checkbox"/>	MC612PA	1SNK150201R0000	5	11.00
Card with 100 markers, ascending order					
1->100	White <input type="checkbox"/>	MC612PA	1SNK155011R0000	5	11.00
101->200	White <input type="checkbox"/>	MC612PA	1SNK155021R0000	5	11.00
201->300	White <input type="checkbox"/>	MC612PA	1SNK155031R0000	5	11.00
301->400	White <input type="checkbox"/>	MC612PA	1SNK155041R0000	5	11.00
401->500	White <input type="checkbox"/>	MC612PA	1SNK155051R0000	5	11.00
501->600	White <input type="checkbox"/>	MC612PA	1SNK155061R0000	5	11.00
601->700	White <input type="checkbox"/>	MC612PA	1SNK155071R0000	5	11.00
701->800	White <input type="checkbox"/>	MC612PA	1SNK155081R0000	5	11.00
801->900	White <input type="checkbox"/>	MC612PA	1SNK155091R0000	5	11.00
Card with 100 markers, repeated identical numbers					
0 (x100)	White <input type="checkbox"/>	MC612PA	1SNK157001R0000	5	11.00
1 (x100)	White <input type="checkbox"/>	MC612PA	1SNK157011R0000	5	11.00
2 (x100)	White <input type="checkbox"/>	MC612PA	1SNK157021R0000	5	11.00
3 (x100)	White <input type="checkbox"/>	MC612PA	1SNK157031R0000	5	11.00
4 (x100)	White <input type="checkbox"/>	MC612PA	1SNK157041R0000	5	11.00
5 (x100)	White <input type="checkbox"/>	MC612PA	1SNK157051R0000	5	11.00
6 (x100)	White <input type="checkbox"/>	MC612PA	1SNK157061R0000	5	11.00
7 (x100)	White <input type="checkbox"/>	MC612PA	1SNK157071R0000	5	11.00
8 (x100)	White <input type="checkbox"/>	MC612PA	1SNK157081R0000	5	11.00
9 (x100)	White <input type="checkbox"/>	MC612PA	1SNK157091R0000	5	11.00
Card with 100 markers, repeated identical letters					
A (x100)	White <input type="checkbox"/>	MC612PA	1SNK156011R0000	5	11.00
B (x100)	White <input type="checkbox"/>	MC612PA	1SNK156021R0000	5	11.00
C (x100)	White <input type="checkbox"/>	MC612PA	1SNK156031R0000	5	11.00
D (x100)	White <input type="checkbox"/>	MC612PA	1SNK156041R0000	5	11.00
E (x100)	White <input type="checkbox"/>	MC612PA	1SNK156051R0000	5	11.00
F (x100)	White <input type="checkbox"/>	MC612PA	1SNK156061R0000	5	11.00
G (x100)	White <input type="checkbox"/>	MC612PA	1SNK156071R0000	5	11.00
H (x100)	White <input type="checkbox"/>	MC612PA	1SNK156081R0000	5	11.00
I (x100)	White <input type="checkbox"/>	MC612PA	1SNK156091R0000	5	11.00
J (x100)	White <input type="checkbox"/>	MC612PA	1SNK156101R0000	5	11.00
K (x100)	White <input type="checkbox"/>	MC612PA	1SNK156111R0000	5	11.00

Continue on next page →

MC612PA terminal block markers

Pre-printed markers for SNK series

6 mm 0.236 in spacing - horizontal mounting

Ordering details

Description	Color	Type	Part Number	Pkg card	Weight (1 card) g
← Continuation of previous page					
L (x100)	White	<input type="checkbox"/> MC612PA	1SNK156121R0000	5	11.00
M (x100)	White	<input type="checkbox"/> MC612PA	1SNK156131R0000	5	11.00
N (x100)	White	<input type="checkbox"/> MC612PA	1SNK156141R0000	5	11.00
O (x100)	White	<input type="checkbox"/> MC612PA	1SNK156151R0000	5	11.00
P (x100)	White	<input type="checkbox"/> MC612PA	1SNK156161R0000	5	11.00
Q (x100)	White	<input type="checkbox"/> MC612PA	1SNK156171R0000	5	11.00
R (x100)	White	<input type="checkbox"/> MC612PA	1SNK156181R0000	5	11.00
S (x100)	White	<input type="checkbox"/> MC612PA	1SNK156191R0000	5	11.00
T (x100)	White	<input type="checkbox"/> MC612PA	1SNK156201R0000	5	11.00
U (x100)	White	<input type="checkbox"/> MC612PA	1SNK156211R0000	5	11.00
V (x100)	White	<input type="checkbox"/> MC612PA	1SNK156221R0000	5	11.00
W (x100)	White	<input type="checkbox"/> MC612PA	1SNK156231R0000	5	11.00
X (x100)	White	<input type="checkbox"/> MC612PA	1SNK156241R0000	5	11.00
Y (x100)	White	<input type="checkbox"/> MC612PA	1SNK156251R0000	5	11.00
Z (x100)	White	<input type="checkbox"/> MC612PA	1SNK156261R0000	5	11.00

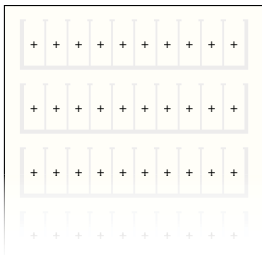

Card with 100 markers, repeated identical symbols

+ (x100)	White	<input type="checkbox"/> MC612PA	1SNK158001R0000	5	11.00
- (x100)	White	<input type="checkbox"/> MC612PA	1SNK158011R0000	5	11.00
~ (x100)	White	<input type="checkbox"/> MC612PA	1SNK158021R0000	5	11.00
= (x100)	White	<input type="checkbox"/> MC612PA	1SNK158031R0000	5	11.00
± (x100)	White	<input type="checkbox"/> MC612PA	1SNK158041R0000	5	11.00
L1 (x100)	White	<input type="checkbox"/> MC612PA	1SNK158051R0000	5	11.00
L2 (x100)	White	<input type="checkbox"/> MC612PA	1SNK158061R0000	5	11.00
L3 (x100)	White	<input type="checkbox"/> MC612PA	1SNK158071R0000	5	11.00
PE (x100)	White	<input type="checkbox"/> MC612PA	1SNK158091R0000	5	11.00
U1 (x100)	White	<input type="checkbox"/> MC612PA	1SNK158101R0000	5	11.00
U2 (x100)	White	<input type="checkbox"/> MC612PA	1SNK158111R0000	5	11.00
U3 (x100)	White	<input type="checkbox"/> MC612PA	1SNK158121R0000	5	11.00
V1 (x100)	White	<input type="checkbox"/> MC612PA	1SNK158131R0000	5	11.00
V2 (x100)	White	<input type="checkbox"/> MC612PA	1SNK158141R0000	5	11.00
V3 (x100)	White	<input type="checkbox"/> MC612PA	1SNK158151R0000	5	11.00
W1 (x100)	White	<input type="checkbox"/> MC612PA	1SNK158161R0000	5	11.00
W2 (x100)	White	<input type="checkbox"/> MC612PA	1SNK158171R0000	5	11.00
W3 (x100)	White	<input type="checkbox"/> MC612PA	1SNK158181R0000	5	11.00

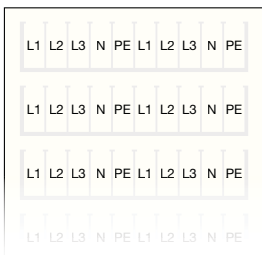

Card with 100 markers, 5 different symbols repeated 20 times

L1-L2-L3-N-PE (x20)	White	<input type="checkbox"/> MC612PA	1SNK159001R0000	5	11.00
---------------------	-------	----------------------------------	-----------------	---	-------



Card with 100 markers, 9 different symbols repeated 10 times

U1-U2-U3-V1-V2-V3-W1-W2-W3 (x10) + U1 (x10)	White	<input type="checkbox"/> MC612PA	1SNK159011R0000	5	11.00
---	-------	----------------------------------	-----------------	---	-------

MC612PA terminal block markers

Pre-printed markers for SNK series

6 mm 0.236 in spacing - vertical mounting

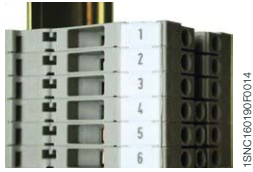

Vertical terminal block assembly

Description

– Save printing time with our large pre-printed card offer with pre-printed numbers, letters or symbols.

Main technical data

Material	Flammability
Polyamide	V2

Ordering details

Description	Color	Type	Part Number	Pkg card	Weight (1 card) g
Card with 100 markers, ascending order repeated 10 times					
1->10 (x10)	White <input type="checkbox"/>	MC612PA	1SNK150012R0000	5	11.00
11->20 (x10)	White <input type="checkbox"/>	MC612PA	1SNK150022R0000	5	11.00
21->30 (x10)	White <input type="checkbox"/>	MC612PA	1SNK150032R0000	5	11.00
31->40 (x10)	White <input type="checkbox"/>	MC612PA	1SNK150042R0000	5	11.00
41->50 (x10)	White <input type="checkbox"/>	MC612PA	1SNK150052R0000	5	11.00
51->60 (x10)	White <input type="checkbox"/>	MC612PA	1SNK150062R0000	5	11.00
61->70 (x10)	White <input type="checkbox"/>	MC612PA	1SNK150072R0000	5	11.00
71->80 (x10)	White <input type="checkbox"/>	MC612PA	1SNK150082R0000	5	11.00
81->90 (x10)	White <input type="checkbox"/>	MC612PA	1SNK150084R0000	5	11.00
0->9 (x10)	White <input type="checkbox"/>	MC612PA	1SNK150092R0000	5	11.00
91->100 (x10)	White <input type="checkbox"/>	MC612PA	1SNK150102R0000	5	11.00
101->110 (x10)	White <input type="checkbox"/>	MC612PA	1SNK150112R0000	5	11.00
111->120 (x10)	White <input type="checkbox"/>	MC612PA	1SNK150122R0000	5	11.00
121->130 (x10)	White <input type="checkbox"/>	MC612PA	1SNK150132R0000	5	11.00
131->140 (x10)	White <input type="checkbox"/>	MC612PA	1SNK150142R0000	5	11.00
141->150 (x10)	White <input type="checkbox"/>	MC612PA	1SNK150152R0000	5	11.00
151->160 (x10)	White <input type="checkbox"/>	MC612PA	1SNK150162R0000	5	11.00
161->170 (x10)	White <input type="checkbox"/>	MC612PA	1SNK150172R0000	5	11.00
171->180 (x10)	White <input type="checkbox"/>	MC612PA	1SNK150182R0000	5	11.00
181->190 (x10)	White <input type="checkbox"/>	MC612PA	1SNK150192R0000	5	11.00
191->200 (x10)	White <input type="checkbox"/>	MC612PA	1SNK150202R0000	5	11.00
Card with 100 markers, ascending order					
1->100	White <input type="checkbox"/>	MC612PA	1SNK155012R0000	5	11.00
101->200	White <input type="checkbox"/>	MC612PA	1SNK155022R0000	5	11.00
201->300	White <input type="checkbox"/>	MC612PA	1SNK155032R0000	5	11.00
301->400	White <input type="checkbox"/>	MC612PA	1SNK155042R0000	5	11.00
401->500	White <input type="checkbox"/>	MC612PA	1SNK155052R0000	5	11.00
501->600	White <input type="checkbox"/>	MC612PA	1SNK155062R0000	5	11.00
601->700	White <input type="checkbox"/>	MC612PA	1SNK155072R0000	5	11.00
701->800	White <input type="checkbox"/>	MC612PA	1SNK155082R0000	5	11.00
801->900	White <input type="checkbox"/>	MC612PA	1SNK155092R0000	5	11.00
901->1000	White <input type="checkbox"/>	MC612PA	1SNK155102R0000	5	11.00
Card with 100 markers, repeated identical numbers					
0 (x100)	White <input type="checkbox"/>	MC612PA	1SNK157002R0000	5	11.00
1 (x100)	White <input type="checkbox"/>	MC612PA	1SNK157012R0000	5	11.00
2 (x100)	White <input type="checkbox"/>	MC612PA	1SNK157022R0000	5	11.00
3 (x100)	White <input type="checkbox"/>	MC612PA	1SNK157032R0000	5	11.00
4 (x100)	White <input type="checkbox"/>	MC612PA	1SNK157042R0000	5	11.00
5 (x100)	White <input type="checkbox"/>	MC612PA	1SNK157052R0000	5	11.00
6 (x100)	White <input type="checkbox"/>	MC612PA	1SNK157062R0000	5	11.00
7 (x100)	White <input type="checkbox"/>	MC612PA	1SNK157072R0000	5	11.00
8 (x100)	White <input type="checkbox"/>	MC612PA	1SNK157082R0000	5	11.00
9 (x100)	White <input type="checkbox"/>	MC612PA	1SNK157092R0000	5	11.00
Card with 100 markers, repeated identical letters					
A (x100)	White <input type="checkbox"/>	MC612PA	1SNK156012R0000	5	11.00
B (x100)	White <input type="checkbox"/>	MC612PA	1SNK156022R0000	5	11.00
C (x100)	White <input type="checkbox"/>	MC612PA	1SNK156032R0000	5	11.00
D (x100)	White <input type="checkbox"/>	MC612PA	1SNK156042R0000	5	11.00
E (x100)	White <input type="checkbox"/>	MC612PA	1SNK156052R0000	5	11.00
F (x100)	White <input type="checkbox"/>	MC612PA	1SNK156062R0000	5	11.00
G (x100)	White <input type="checkbox"/>	MC612PA	1SNK156072R0000	5	11.00
H (x100)	White <input type="checkbox"/>	MC612PA	1SNK156082R0000	5	11.00
I (x100)	White <input type="checkbox"/>	MC612PA	1SNK156092R0000	5	11.00
J (x100)	White <input type="checkbox"/>	MC612PA	1SNK156102R0000	5	11.00

Continue on next page →

MC612PA terminal block markers

Pre-printed markers for SNK series

6 mm 0.236 in spacing - vertical mounting

Ordering details

Description	Color	Type	Part Number	Pkg card	Weight (1 card) g
← Continuation of previous page					
K (x100)	White	MC612PA	1SNK156112R0000	5	11.00
L (x100)	White	MC612PA	1SNK156122R0000	5	11.00
M (x100)	White	MC612PA	1SNK156132R0000	5	11.00
N (x100)	White	MC612PA	1SNK156142R0000	5	11.00
O (x100)	White	MC612PA	1SNK156152R0000	5	11.00
P (x100)	White	MC612PA	1SNK156162R0000	5	11.00
Q (x100)	White	MC612PA	1SNK156172R0000	5	11.00
R (x100)	White	MC612PA	1SNK156182R0000	5	11.00
S (x100)	White	MC612PA	1SNK156192R0000	5	11.00
T (x100)	White	MC612PA	1SNK156202R0000	5	11.00
U (x100)	White	MC612PA	1SNK156212R0000	5	11.00
V (x100)	White	MC612PA	1SNK156222R0000	5	11.00
W (x100)	White	MC612PA	1SNK156232R0000	5	11.00
X (x100)	White	MC612PA	1SNK156242R0000	5	11.00
Y (x100)	White	MC612PA	1SNK156252R0000	5	11.00
Z (x100)	White	MC612PA	1SNK156262R0000	5	11.00

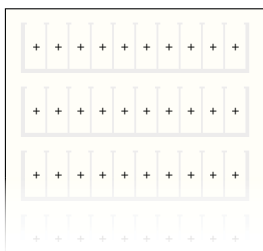

Card with 100 markers, repeated identical symbols

+ (x100)	White	MC612PA	1SNK158002R0000	5	11.00
- (x100)	White	MC612PA	1SNK158012R0000	5	11.00
~ (x100)	White	MC612PA	1SNK158022R0000	5	11.00
= (x100)	White	MC612PA	1SNK158032R0000	5	11.00
± (x100)	White	MC612PA	1SNK158042R0000	5	11.00
L1 (x100)	White	MC612PA	1SNK158052R0000	5	11.00
L2 (x100)	White	MC612PA	1SNK158062R0000	5	11.00
L3 (x100)	White	MC612PA	1SNK158072R0000	5	11.00
PE (x100)	White	MC612PA	1SNK158092R0000	5	11.00
U1 (x100)	White	MC612PA	1SNK158102R0000	5	11.00
U2 (x100)	White	MC612PA	1SNK158112R0000	5	11.00
U3 (x100)	White	MC612PA	1SNK158122R0000	5	11.00
V1 (x100)	White	MC612PA	1SNK158132R0000	5	11.00
V2 (x100)	White	MC612PA	1SNK158142R0000	5	11.00
V3 (x100)	White	MC612PA	1SNK158152R0000	5	11.00
W1 (x100)	White	MC612PA	1SNK158162R0000	5	11.00
W2 (x100)	White	MC612PA	1SNK158172R0000	5	11.00
W3 (x100)	White	MC612PA	1SNK158182R0000	5	11.00
+24V (x100)	White	MC612PA	1SNK158192R0000	5	11.00
+48V (x100)	White	MC612PA	1SNK158202R0000	5	11.00
-24V (x100)	White	MC612PA	1SNK158212R0000	5	11.00
-48V (x100)	White	MC612PA	1SNK158222R0000	5	11.00



Card with 100 markers, 5 different symbols repeated 20 times

L1-L2-L3-N-PE (x20)	White	MC612PA	1SNK159002R0000	5	11.00
---------------------	-------	---------	-----------------	---	-------

Card with 100 markers, 9 different symbols repeated 10 times

U1-U2-U3-V1-V2-V3-W1-W2-W3 (x10) + U1 (x10)	White	MC612PA	1SNK159012R0000	5	11.00
---	-------	---------	-----------------	---	-------

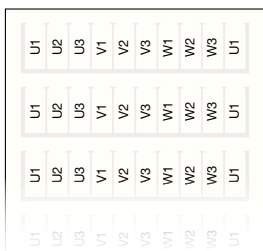

MC812PA terminal block markers

Pre-printed markers for SNK series

8 mm 0.315 in spacing - horizontal mounting



Horizontal terminal block assembly

Description

– Save printing time with our large pre-printed card offer with pre-printed numbers, letters or symbols.

Main technical data

Material	Flammability
Polyamide	V2

Ordering details

Description	Color	Type	Part Number	Pkg card	Weight (1 card) g
-------------	-------	------	-------------	----------	-------------------

Card with 100 markers, ascending order repeated 10 times

0->9 (x10)	White	<input type="checkbox"/>	MC812PA	1SNK160091R0000	5	14.00
1->10 (x10)	White	<input type="checkbox"/>	MC812PA	1SNK160011R0000	5	14.00
11->20 (x10)	White	<input type="checkbox"/>	MC812PA	1SNK160021R0000	5	14.00
21->30 (x10)	White	<input type="checkbox"/>	MC812PA	1SNK160031R0000	5	14.00
31->40 (x10)	White	<input type="checkbox"/>	MC812PA	1SNK160041R0000	5	14.00
41->50 (x10)	White	<input type="checkbox"/>	MC812PA	1SNK160051R0000	5	14.00
51->60 (x10)	White	<input type="checkbox"/>	MC812PA	1SNK160061R0000	5	14.00
61->70 (x10)	White	<input type="checkbox"/>	MC812PA	1SNK160071R0000	5	14.00
71->80 (x10)	White	<input type="checkbox"/>	MC812PA	1SNK160081R0000	5	14.00
81->90 (x10)	White	<input type="checkbox"/>	MC812PA	1SNK160083R0000	5	14.00
91->100 (x10)	White	<input type="checkbox"/>	MC812PA	1SNK160101R0000	5	14.00
101->110 (x10)	White	<input type="checkbox"/>	MC812PA	1SNK160111R0000	5	14.00
111->120 (x10)	White	<input type="checkbox"/>	MC812PA	1SNK160121R0000	5	14.00
121->130 (x10)	White	<input type="checkbox"/>	MC812PA	1SNK160131R0000	5	14.00
131->140 (x10)	White	<input type="checkbox"/>	MC812PA	1SNK160141R0000	5	14.00
141->150 (x10)	White	<input type="checkbox"/>	MC812PA	1SNK160151R0000	5	14.00
151->160 (x10)	White	<input type="checkbox"/>	MC812PA	1SNK160161R0000	5	14.00
161->170 (x10)	White	<input type="checkbox"/>	MC812PA	1SNK160171R0000	5	14.00
171->180 (x10)	White	<input type="checkbox"/>	MC812PA	1SNK160181R0000	5	14.00
181->190 (x10)	White	<input type="checkbox"/>	MC812PA	1SNK160191R0000	5	14.00
191->200 (x10)	White	<input type="checkbox"/>	MC812PA	1SNK160201R0000	5	14.00

Card with 100 markers, ascending order

1->100	White	<input type="checkbox"/>	MC812PA	1SNK165011R0000	5	14.00
101->200	White	<input type="checkbox"/>	MC812PA	1SNK165021R0000	5	14.00
201->300	White	<input type="checkbox"/>	MC812PA	1SNK165031R0000	5	14.00
301->400	White	<input type="checkbox"/>	MC812PA	1SNK165041R0000	5	14.00
401->500	White	<input type="checkbox"/>	MC812PA	1SNK165051R0000	5	14.00
501->600	White	<input type="checkbox"/>	MC812PA	1SNK165061R0000	5	14.00
601->700	White	<input type="checkbox"/>	MC812PA	1SNK165071R0000	5	14.00
701->800	White	<input type="checkbox"/>	MC812PA	1SNK165081R0000	5	14.00
801->900	White	<input type="checkbox"/>	MC812PA	1SNK165091R0000	5	14.00

Card with 100 markers, repeated identical numbers

0 (x100)	White	<input type="checkbox"/>	MC812PA	1SNK167001R0000	5	14.00
1 (x100)	White	<input type="checkbox"/>	MC812PA	1SNK167011R0000	5	14.00
2 (x100)	White	<input type="checkbox"/>	MC812PA	1SNK167021R0000	5	14.00
3 (x100)	White	<input type="checkbox"/>	MC812PA	1SNK167031R0000	5	14.00
4 (x100)	White	<input type="checkbox"/>	MC812PA	1SNK167041R0000	5	14.00
5 (x100)	White	<input type="checkbox"/>	MC812PA	1SNK167051R0000	5	14.00
6 (x100)	White	<input type="checkbox"/>	MC812PA	1SNK167061R0000	5	14.00
7 (x100)	White	<input type="checkbox"/>	MC812PA	1SNK167071R0000	5	14.00
8 (x100)	White	<input type="checkbox"/>	MC812PA	1SNK167081R0000	5	14.00
9 (x100)	White	<input type="checkbox"/>	MC812PA	1SNK167091R0000	5	14.00

Card with 100 markers, repeated identical letters

A (x100)	White	<input type="checkbox"/>	MC812PA	1SNK166011R0000	5	14.00
B (x100)	White	<input type="checkbox"/>	MC812PA	1SNK166021R0000	5	14.00
C (x100)	White	<input type="checkbox"/>	MC812PA	1SNK166031R0000	5	14.00
D (x100)	White	<input type="checkbox"/>	MC812PA	1SNK166041R0000	5	14.00
E (x100)	White	<input type="checkbox"/>	MC812PA	1SNK166051R0000	5	14.00
F (x100)	White	<input type="checkbox"/>	MC812PA	1SNK166061R0000	5	14.00
G (x100)	White	<input type="checkbox"/>	MC812PA	1SNK166071R0000	5	14.00
H (x100)	White	<input type="checkbox"/>	MC812PA	1SNK166081R0000	5	14.00
I (x100)	White	<input type="checkbox"/>	MC812PA	1SNK166091R0000	5	14.00
J (x100)	White	<input type="checkbox"/>	MC812PA	1SNK166101R0000	5	14.00
K (x100)	White	<input type="checkbox"/>	MC812PA	1SNK166111R0000	5	14.00

Continue on next page →

MC812PA terminal block markers

Pre-printed markers for SNK series

8 mm 0.315 in spacing - horizontal mounting

Ordering details

Description	Color	Type	Part Number	Pkg card	Weight (1 card) g
← Continuation of previous page					
L (x100)	White	<input type="checkbox"/> MC812PA	1SNK166121R0000	5	14.00
M (x100)	White	<input type="checkbox"/> MC812PA	1SNK166131R0000	5	14.00
N (x100)	White	<input type="checkbox"/> MC812PA	1SNK166141R0000	5	14.00
O (x100)	White	<input type="checkbox"/> MC812PA	1SNK166151R0000	5	14.00
P (x100)	White	<input type="checkbox"/> MC812PA	1SNK166161R0000	5	14.00
Q (x100)	White	<input type="checkbox"/> MC812PA	1SNK166171R0000	5	14.00
R (x100)	White	<input type="checkbox"/> MC812PA	1SNK166181R0000	5	14.00
S (x100)	White	<input type="checkbox"/> MC812PA	1SNK166191R0000	5	14.00
T (x100)	White	<input type="checkbox"/> MC812PA	1SNK166201R0000	5	14.00
U (x100)	White	<input type="checkbox"/> MC812PA	1SNK166211R0000	5	14.00
V (x100)	White	<input type="checkbox"/> MC812PA	1SNK166221R0000	5	14.00
W (x100)	White	<input type="checkbox"/> MC812PA	1SNK166231R0000	5	14.00
X (x100)	White	<input type="checkbox"/> MC812PA	1SNK166241R0000	5	14.00
Y (x100)	White	<input type="checkbox"/> MC812PA	1SNK166251R0000	5	14.00
Z (x100)	White	<input type="checkbox"/> MC812PA	1SNK166261R0000	5	14.00

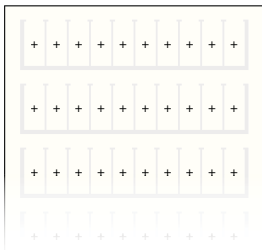

Card with 100 markers, repeated identical symbols

+ (x100)	White	<input type="checkbox"/> MC812PA	1SNK168001R0000	5	14.00
- (x100)	White	<input type="checkbox"/> MC812PA	1SNK168011R0000	5	14.00
~ (x100)	White	<input type="checkbox"/> MC812PA	1SNK168021R0000	5	14.00
= (x100)	White	<input type="checkbox"/> MC812PA	1SNK168031R0000	5	14.00
≡ (x100)	White	<input type="checkbox"/> MC812PA	1SNK168041R0000	5	14.00
L1 (x100)	White	<input type="checkbox"/> MC812PA	1SNK168051R0000	5	14.00
L2 (x100)	White	<input type="checkbox"/> MC812PA	1SNK168061R0000	5	14.00
L3 (x100)	White	<input type="checkbox"/> MC812PA	1SNK168071R0000	5	14.00
PE (x100)	White	<input type="checkbox"/> MC812PA	1SNK168091R0000	5	14.00
U1 (x100)	White	<input type="checkbox"/> MC812PA	1SNK168101R0000	5	14.00
U2 (x100)	White	<input type="checkbox"/> MC812PA	1SNK168111R0000	5	14.00
U3 (x100)	White	<input type="checkbox"/> MC812PA	1SNK168121R0000	5	14.00
V1 (x100)	White	<input type="checkbox"/> MC812PA	1SNK168131R0000	5	14.00
V2 (x100)	White	<input type="checkbox"/> MC812PA	1SNK168141R0000	5	14.00
V3 (x100)	White	<input type="checkbox"/> MC812PA	1SNK168151R0000	5	14.00
W1 (x100)	White	<input type="checkbox"/> MC812PA	1SNK168161R0000	5	14.00
W2 (x100)	White	<input type="checkbox"/> MC812PA	1SNK168171R0000	5	14.00
W3 (x100)	White	<input type="checkbox"/> MC812PA	1SNK168181R0000	5	14.00

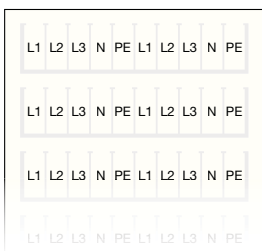

Card with 100 markers, 5 different symbols repeated 20 times

L1-L2-L3-N-PE (x20)	White	<input type="checkbox"/> MC812PA	1SNK169001R0000	5	14.00
---------------------	-------	----------------------------------	-----------------	---	-------



Card with 100 markers, 9 different symbols repeated 10 times

U1-U2-U3-V1-V2-V3-W1-W2-W3 (x10) + U1 (x10)	White	<input type="checkbox"/> MC812PA	1SNK169011R0000	5	14.00
---	-------	----------------------------------	-----------------	---	-------

MC812PA terminal block markers

Pre-printed markers for SNK series

8 mm 0.315 in spacing - vertical mounting



Vertical terminal block assembly

Description

– Save printing time with our large pre-printed card offer with pre-printed numbers, letters or symbols.

Main technical data

Material	Flammability
Polyamide	V2

Ordering details

Description	Color	Type	Part Number	Pkg card	Weight (1 card) g
Card with 100 markers, ascending order repeated 10 times					
0->9 (x10)	White <input type="checkbox"/>	MC812PA	1SNK160092R0000	5	14.00
1->10 (x10)	White <input type="checkbox"/>	MC812PA	1SNK160012R0000	5	14.00
11->20 (x10)	White <input type="checkbox"/>	MC812PA	1SNK160022R0000	5	14.00
21->30 (x10)	White <input type="checkbox"/>	MC812PA	1SNK160032R0000	5	14.00
31->40 (x10)	White <input type="checkbox"/>	MC812PA	1SNK160042R0000	5	14.00
41->50 (x10)	White <input type="checkbox"/>	MC812PA	1SNK160052R0000	5	14.00
51->60 (x10)	White <input type="checkbox"/>	MC812PA	1SNK160062R0000	5	14.00
61->70 (x10)	White <input type="checkbox"/>	MC812PA	1SNK160072R0000	5	14.00
71->80 (x10)	White <input type="checkbox"/>	MC812PA	1SNK160082R0000	5	14.00
81->90 (x10)	White <input type="checkbox"/>	MC812PA	1SNK160084R0000	5	14.00
91->100 (x10)	White <input type="checkbox"/>	MC812PA	1SNK160102R0000	5	14.00
101->110 (x10)	White <input type="checkbox"/>	MC812PA	1SNK160112R0000	5	14.00
111->120 (x10)	White <input type="checkbox"/>	MC812PA	1SNK160122R0000	5	14.00
121->130 (x10)	White <input type="checkbox"/>	MC812PA	1SNK160132R0000	5	14.00
131->140 (x10)	White <input type="checkbox"/>	MC812PA	1SNK160142R0000	5	14.00
141->150 (x10)	White <input type="checkbox"/>	MC812PA	1SNK160152R0000	5	14.00
151->160 (x10)	White <input type="checkbox"/>	MC812PA	1SNK160162R0000	5	14.00
161->170 (x10)	White <input type="checkbox"/>	MC812PA	1SNK160172R0000	5	14.00
171->180 (x10)	White <input type="checkbox"/>	MC812PA	1SNK160182R0000	5	14.00
181->190 (x10)	White <input type="checkbox"/>	MC812PA	1SNK160192R0000	5	14.00
191->200 (x10)	White <input type="checkbox"/>	MC812PA	1SNK160202R0000	5	14.00
Card with 100 markers, ascending order					
1->100	White <input type="checkbox"/>	MC812PA	1SNK165012R0000	5	14.00
101->200	White <input type="checkbox"/>	MC812PA	1SNK165022R0000	5	14.00
201->300	White <input type="checkbox"/>	MC812PA	1SNK165032R0000	5	14.00
301->400	White <input type="checkbox"/>	MC812PA	1SNK165042R0000	5	14.00
401->500	White <input type="checkbox"/>	MC812PA	1SNK165052R0000	5	14.00
501->600	White <input type="checkbox"/>	MC812PA	1SNK165062R0000	5	14.00
601->700	White <input type="checkbox"/>	MC812PA	1SNK165072R0000	5	14.00
701->800	White <input type="checkbox"/>	MC812PA	1SNK165082R0000	5	14.00
801->900	White <input type="checkbox"/>	MC812PA	1SNK165092R0000	5	14.00
901->1000	White <input type="checkbox"/>	MC812PA	1SNK165102R0000	5	14.00
Card with 100 markers, repeated identical numbers					
0 (x100)	White <input type="checkbox"/>	MC812PA	1SNK167002R0000	5	14.00
1 (x100)	White <input type="checkbox"/>	MC812PA	1SNK167012R0000	5	14.00
2 (x100)	White <input type="checkbox"/>	MC812PA	1SNK167022R0000	5	14.00
3 (x100)	White <input type="checkbox"/>	MC812PA	1SNK167032R0000	5	14.00
4 (x100)	White <input type="checkbox"/>	MC812PA	1SNK167042R0000	5	14.00
5 (x100)	White <input type="checkbox"/>	MC812PA	1SNK167052R0000	5	14.00
6 (x100)	White <input type="checkbox"/>	MC812PA	1SNK167062R0000	5	14.00
7 (x100)	White <input type="checkbox"/>	MC812PA	1SNK167072R0000	5	14.00
8 (x100)	White <input type="checkbox"/>	MC812PA	1SNK167082R0000	5	14.00
9 (x100)	White <input type="checkbox"/>	MC812PA	1SNK167092R0000	5	14.00
Card with 100 markers, repeated identical letters					
A (x100)	White <input type="checkbox"/>	MC812PA	1SNK166012R0000	5	14.00
B (x100)	White <input type="checkbox"/>	MC812PA	1SNK166022R0000	5	14.00
C (x100)	White <input type="checkbox"/>	MC812PA	1SNK166032R0000	5	14.00
D (x100)	White <input type="checkbox"/>	MC812PA	1SNK166042R0000	5	14.00
E (x100)	White <input type="checkbox"/>	MC812PA	1SNK166052R0000	5	14.00
F (x100)	White <input type="checkbox"/>	MC812PA	1SNK166062R0000	5	14.00
G (x100)	White <input type="checkbox"/>	MC812PA	1SNK166072R0000	5	14.00
H (x100)	White <input type="checkbox"/>	MC812PA	1SNK166082R0000	5	14.00
I (x100)	White <input type="checkbox"/>	MC812PA	1SNK166092R0000	5	14.00
J (x100)	White <input type="checkbox"/>	MC812PA	1SNK166102R0000	5	14.00

Continue on next page →

MC812PA terminal block markers

Pre-printed markers for SNK series

8 mm 0.315 in spacing - vertical mounting

Ordering details

Description	Color	Type	Part Number	Pkg card	Weight (1 card) g
← Continuation of previous page					
K (x100)	White	MC812PA	1SNK166112R0000	5	14.00
L (x100)	White	MC812PA	1SNK166122R0000	5	14.00
M (x100)	White	MC812PA	1SNK166132R0000	5	14.00
N (x100)	White	MC812PA	1SNK166142R0000	5	14.00
O (x100)	White	MC812PA	1SNK166152R0000	5	14.00
P (x100)	White	MC812PA	1SNK166162R0000	5	14.00
Q (x100)	White	MC812PA	1SNK166172R0000	5	14.00
R (x100)	White	MC812PA	1SNK166182R0000	5	14.00
S (x100)	White	MC812PA	1SNK166192R0000	5	14.00
T (x100)	White	MC812PA	1SNK166202R0000	5	14.00
U (x100)	White	MC812PA	1SNK166212R0000	5	14.00
V (x100)	White	MC812PA	1SNK166222R0000	5	14.00
W (x100)	White	MC812PA	1SNK166232R0000	5	14.00
X (x100)	White	MC812PA	1SNK166242R0000	5	14.00
Y (x100)	White	MC812PA	1SNK166252R0000	5	14.00
Z (x100)	White	MC812PA	1SNK166262R0000	5	14.00

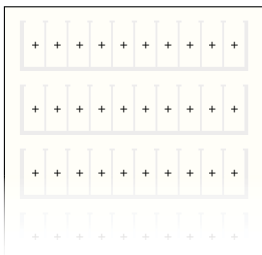

Card with 100 markers, repeated identical symbols

+ (x100)	White	MC812PA	1SNK168002R0000	5	14.00
- (x100)	White	MC812PA	1SNK168012R0000	5	14.00
~ (x100)	White	MC812PA	1SNK168022R0000	5	14.00
= (x100)	White	MC812PA	1SNK168032R0000	5	14.00
± (x100)	White	MC812PA	1SNK168042R0000	5	14.00
L1 (x100)	White	MC812PA	1SNK168052R0000	5	14.00
L2 (x100)	White	MC812PA	1SNK168062R0000	5	14.00
L3 (x100)	White	MC812PA	1SNK168072R0000	5	14.00
PE (x100)	White	MC812PA	1SNK168092R0000	5	14.00
U1 (x100)	White	MC812PA	1SNK168102R0000	5	14.00
U2 (x100)	White	MC812PA	1SNK168112R0000	5	14.00
U3 (x100)	White	MC812PA	1SNK168122R0000	5	14.00
V1 (x100)	White	MC812PA	1SNK168132R0000	5	14.00
V2 (x100)	White	MC812PA	1SNK168142R0000	5	14.00
V3 (x100)	White	MC812PA	1SNK168152R0000	5	14.00
W1 (x100)	White	MC812PA	1SNK168162R0000	5	14.00
W2 (x100)	White	MC812PA	1SNK168172R0000	5	14.00
W3 (x100)	White	MC812PA	1SNK168182R0000	5	14.00
+24V (x100)	White	MC812PA	1SNK168192R0000	5	14.00
+48V (x100)	White	MC812PA	1SNK168202R0000	5	14.00
-24V (x100)	White	MC812PA	1SNK168212R0000	5	14.00
-48V (x100)	White	MC812PA	1SNK168222R0000	5	14.00

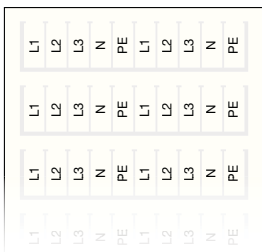

Card with 100 markers, 5 different symbols repeated 20 times

L1-L2-L3-N-PE (x20)	White	MC812PA	1SNK169002R0000	5	14.00
---------------------	-------	---------	-----------------	---	-------

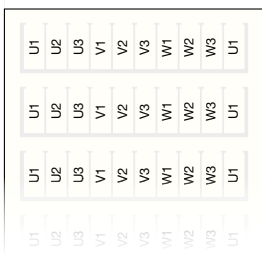

Card with 100 markers, 9 different symbols repeated 10 times

U1-U2-U3-V1-V2-V3-W1-W2-W3 (x10) + U1 (x10)	White	MC812PA	1SNK169012R0000	5	14.00
---	-------	---------	-----------------	---	-------

RC410 terminal block markers

Pre-printed markers for SNA and Solution series

4 mm 0.157 in spacing - horizontal mounting



Horizontal terminal block assembly



Description

- Save printing time with our large pre-printed card offer with pre-printed numbers, letters or symbols,
- To be used to mark spring clamp terminal blocks and screw clamp miniblocks (DR..) from the SNA and Solution series.

Main technical data

Material	Flammability
Polyamide	V2

Ordering details

Description	Color	Type	Part Number	Pkg card	Weight (1 card) g
Card with 100 markers, ascending order repeated 10 times					
0->9 (x10)	White <input type="checkbox"/>	RC410	1SNA229001R0200	5	5.20
1->10 (x10)	White <input type="checkbox"/>	RC410	1SNA229002R0300	5	5.20
11->20 (x10)	White <input type="checkbox"/>	RC410	1SNA229003R0400	5	5.20
21->30 (x10)	White <input type="checkbox"/>	RC410	1SNA229004R0500	5	5.20
31->40 (x10)	White <input type="checkbox"/>	RC410	1SNA229005R0600	5	5.20
41->50 (x10)	White <input type="checkbox"/>	RC410	1SNA229006R0700	5	5.20
51->60 (x10)	White <input type="checkbox"/>	RC410	1SNA229007R0000	5	5.20
61->70 (x10)	White <input type="checkbox"/>	RC410	1SNA229008R1100	5	5.20
71->80 (x10)	White <input type="checkbox"/>	RC410	1SNA229009R1200	5	5.20
81->90 (x10)	White <input type="checkbox"/>	RC410	1SNA229010R0600	5	5.20
91->100 (x10)	White <input type="checkbox"/>	RC410	1SNA229011R2300	5	5.20
Card with 100 markers, ascending order					
1->100	White <input type="checkbox"/>	RC410	1SNA229030R0200	5	5.20
Card with 100 markers, repeated identical numbers					
0 (x100)	White <input type="checkbox"/>	RC410	1SNA229210R1300	5	5.20
1 (x100)	White <input type="checkbox"/>	RC410	1SNA229211R0000	5	5.20
2 (x100)	White <input type="checkbox"/>	RC410	1SNA229212R0100	5	5.20
3 (x100)	White <input type="checkbox"/>	RC410	1SNA229213R0200	5	5.20
4 (x100)	White <input type="checkbox"/>	RC410	1SNA229214R0300	5	5.20
5 (x100)	White <input type="checkbox"/>	RC410	1SNA229215R0400	5	5.20
6 (x100) / 9 (x100)	White <input type="checkbox"/>	RC410	1SNA229216R0500	5	5.20
7 (x100)	White <input type="checkbox"/>	RC410	1SNA229217R0600	5	5.20
8 (x100)	White <input type="checkbox"/>	RC410	1SNA229218R1700	5	5.20
10 (x100)	White <input type="checkbox"/>	RC410	1SNA229220R1500	5	5.20
11 (x100)	White <input type="checkbox"/>	RC410	1SNA229221R0200	5	5.20
12 (x100)	White <input type="checkbox"/>	RC410	1SNA229222R0300	5	5.20
13 (x100)	White <input type="checkbox"/>	RC410	1SNA229223R0400	5	5.20
14 (x100)	White <input type="checkbox"/>	RC410	1SNA229224R0500	5	5.20
15 (x100)	White <input type="checkbox"/>	RC410	1SNA229225R0600	5	5.20
16 (x100)	White <input type="checkbox"/>	RC410	1SNA229226R0700	5	5.20
17 (x100)	White <input type="checkbox"/>	RC410	1SNA229227R0000	5	5.20
18 (x100)	White <input type="checkbox"/>	RC410	1SNA229228R1100	5	5.20
19 (x100)	White <input type="checkbox"/>	RC410	1SNA229229R1200	5	5.20
20 (x100)	White <input type="checkbox"/>	RC410	1SNA229230R1700	5	5.20

Continue on next page →

RC410 terminal block markers

Pre-printed markers for SNA and Solution series

4 mm 0.157 in spacing - horizontal mounting

Ordering details

Description	Color	Type	Part Number	Pkg card	Weight (1 card) g
-------------	-------	------	-------------	-------------	----------------------

← Continuation of previous page

Card with 100 markers, repeated identical letters

A (x100)	White	<input type="checkbox"/>	RC410	1SNA229150R1700	5	5.20
B (x100)	White	<input type="checkbox"/>	RC410	1SNA229151R0400	5	5.20
C (x100)	White	<input type="checkbox"/>	RC410	1SNA229152R0500	5	5.20
D (x100)	White	<input type="checkbox"/>	RC410	1SNA229153R0600	5	5.20
E (x100)	White	<input type="checkbox"/>	RC410	1SNA229154R0700	5	5.20
F (x100)	White	<input type="checkbox"/>	RC410	1SNA229155R0000	5	5.20
G (x100)	White	<input type="checkbox"/>	RC410	1SNA229156R0100	5	5.20
H (x100)	White	<input type="checkbox"/>	RC410	1SNA229157R0200	5	5.20
I (x100)	White	<input type="checkbox"/>	RC410	1SNA229158R1300	5	5.20
J (x100)	White	<input type="checkbox"/>	RC410	1SNA229159R1400	5	5.20
K (x100)	White	<input type="checkbox"/>	RC410	1SNA229160R1100	5	5.20
L (x100)	White	<input type="checkbox"/>	RC410	1SNA229161R0600	5	5.20
M (x100)	White	<input type="checkbox"/>	RC410	1SNA229162R0700	5	5.20
N (x100)	White	<input type="checkbox"/>	RC410	1SNA229163R0000	5	5.20
O (x100)	White	<input type="checkbox"/>	RC410	1SNA229164R0100	5	5.20
P (x100)	White	<input type="checkbox"/>	RC410	1SNA229165R0200	5	5.20
Q (x100)	White	<input type="checkbox"/>	RC410	1SNA229166R0300	5	5.20
R (x100)	White	<input type="checkbox"/>	RC410	1SNA229167R0400	5	5.20
S (x100)	White	<input type="checkbox"/>	RC410	1SNA229168R1500	5	5.20
T (x100)	White	<input type="checkbox"/>	RC410	1SNA229169R1600	5	5.20
U (x100)	White	<input type="checkbox"/>	RC410	1SNA229170R1300	5	5.20
V (x100)	White	<input type="checkbox"/>	RC410	1SNA229171R0000	5	5.20
W (x100)	White	<input type="checkbox"/>	RC410	1SNA229172R0100	5	5.20
X (x100)	White	<input type="checkbox"/>	RC410	1SNA229173R0200	5	5.20
Y (x100)	White	<input type="checkbox"/>	RC410	1SNA229174R0300	5	5.20
Z (x100)	White	<input type="checkbox"/>	RC410	1SNA229175R0400	5	5.20

Card with 100 markers, repeated identical symbols

+ (x100)	White	<input type="checkbox"/>	RC410	1SNA229111R2400	5	5.20
- (x100)	White	<input type="checkbox"/>	RC410	1SNA229112R2500	5	5.20
= (x100)	White	<input type="checkbox"/>	RC410	1SNA229113R2600	5	5.20
~ (x100)	White	<input type="checkbox"/>	RC410	1SNA229114R2700	5	5.20
≡ (x100)	White	<input type="checkbox"/>	RC410	1SNA229115R2000	5	5.20

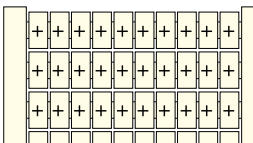

RC410 terminal block markers

Pre-printed markers for SNA and Solution series

4 mm 0.157 in spacing - vertical mounting

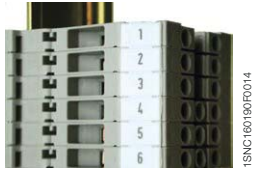

Vertical terminal block assembly

Description

- Save printing time with our large pre-printed card offer with pre-printed numbers, letters or symbols,
- To be used to mark spring clamp terminal blocks and screw clamp miniblocks (DR..) from the SNA and Solution series.

Main technical data

Material	Flammability
Polyamide	V2

Ordering details

Description	Color	Type	Part Number	Pkg card	Weight (1 card) g
Card with 100 markers, ascending order repeated 10 times					
0->9 (x10)	White <input type="checkbox"/>	RC410	1SNA229040R1400	5	5.20
1->10 (x10)	White <input type="checkbox"/>	RC410	1SNA229041R0100	5	5.20
11->20 (x10)	White <input type="checkbox"/>	RC410	1SNA229042R0200	5	5.20
21->30 (x10)	White <input type="checkbox"/>	RC410	1SNA229043R0300	5	5.20
31->40 (x10)	White <input type="checkbox"/>	RC410	1SNA229044R0400	5	5.20
41->50 (x10)	White <input type="checkbox"/>	RC410	1SNA229045R0500	5	5.20
51->60 (x10)	White <input type="checkbox"/>	RC410	1SNA229046R0600	5	5.20
61->70 (x10)	White <input type="checkbox"/>	RC410	1SNA229047R0700	5	5.20
71->80 (x10)	White <input type="checkbox"/>	RC410	1SNA229048R1000	5	5.20
81->90 (x10)	White <input type="checkbox"/>	RC410	1SNA229049R1100	5	5.20
91->100 (x10)	White <input type="checkbox"/>	RC410	1SNA229050R1600	5	5.20
101->110 (x10)	White <input type="checkbox"/>	RC410	1SNA229051R0300	5	5.20
111->120 (x10)	White <input type="checkbox"/>	RC410	1SNA229052R0400	5	5.20
121->130 (x10)	White <input type="checkbox"/>	RC410	1SNA229053R0500	5	5.20
131->140 (x10)	White <input type="checkbox"/>	RC410	1SNA229054R0600	5	5.20
141->150 (x10)	White <input type="checkbox"/>	RC410	1SNA229055R0700	5	5.20
151->160 (x10)	White <input type="checkbox"/>	RC410	1SNA229056R0000	5	5.20
161->170 (x10)	White <input type="checkbox"/>	RC410	1SNA229057R0100	5	5.20
171->180 (x10)	White <input type="checkbox"/>	RC410	1SNA229058R1200	5	5.20
181->190 (x10)	White <input type="checkbox"/>	RC410	1SNA229059R1300	5	5.20
191->200 (x10)	White <input type="checkbox"/>	RC410	1SNA229072R0000	5	5.20
Card with 100 markers, ascending order					
1->100	White <input type="checkbox"/>	RC410	1SNA229060R1000	5	5.20
101->200	White <input type="checkbox"/>	RC410	1SNA229061R0500	5	5.20
201->300	White <input type="checkbox"/>	RC410	1SNA229062R0600	5	5.20
301->400	White <input type="checkbox"/>	RC410	1SNA229063R0700	5	5.20
401->500	White <input type="checkbox"/>	RC410	1SNA229064R0000	5	5.20
501->600	White <input type="checkbox"/>	RC410	1SNA229065R0100	5	5.20
601->700	White <input type="checkbox"/>	RC410	1SNA229066R0200	5	5.20
701->800	White <input type="checkbox"/>	RC410	1SNA229067R0300	5	5.20
801->900	White <input type="checkbox"/>	RC410	1SNA229068R1400	5	5.20
901->1000	White <input type="checkbox"/>	RC410	1SNA229069R1500	5	5.20

Continue on next page →

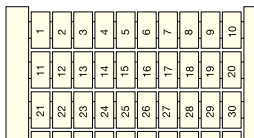

RC410 terminal block markers

Pre-printed markers for SNA and Solution series

4 mm 0.157 in spacing - vertical mounting

Ordering details

Description	Color	Type	Part Number	Pkg card	Weight (1 card) g
-------------	-------	------	-------------	-------------	----------------------

← Continuation of previous page

Card with 100 markers, repeated identical letters

A (x100)	White	<input type="checkbox"/>	RC410	1SNA229180R0600	5	5.20
B (x100)	White	<input type="checkbox"/>	RC410	1SNA229181R2300	5	5.20
C (x100)	White	<input type="checkbox"/>	RC410	1SNA229182R2400	5	5.20
D (x100)	White	<input type="checkbox"/>	RC410	1SNA229183R2500	5	5.20
E (x100)	White	<input type="checkbox"/>	RC410	1SNA229184R2600	5	5.20
F (x100)	White	<input type="checkbox"/>	RC410	1SNA229185R2700	5	5.20
G (x100)	White	<input type="checkbox"/>	RC410	1SNA229186R2000	5	5.20
H (x100)	White	<input type="checkbox"/>	RC410	1SNA229187R2100	5	5.20
I (x100)	White	<input type="checkbox"/>	RC410	1SNA229188R0200	5	5.20
J (x100)	White	<input type="checkbox"/>	RC410	1SNA229189R0300	5	5.20
K (x100)	White	<input type="checkbox"/>	RC410	1SNA229190R0000	5	5.20
L (x100)	White	<input type="checkbox"/>	RC410	1SNA229191R2500	5	5.20
M (x100)	White	<input type="checkbox"/>	RC410	1SNA229192R2600	5	5.20
N (x100)	White	<input type="checkbox"/>	RC410	1SNA229193R2700	5	5.20
O (x100)	White	<input type="checkbox"/>	RC410	1SNA229194R2000	5	5.20
P (x100)	White	<input type="checkbox"/>	RC410	1SNA229195R2100	5	5.20
Q (x100)	White	<input type="checkbox"/>	RC410	1SNA229196R2200	5	5.20
R (x100)	White	<input type="checkbox"/>	RC410	1SNA229197R2300	5	5.20
S (x100)	White	<input type="checkbox"/>	RC410	1SNA229198R0400	5	5.20
T (x100)	White	<input type="checkbox"/>	RC410	1SNA229199R0500	5	5.20
U (x100)	White	<input type="checkbox"/>	RC410	1SNA229200R2200	5	5.20
V (x100)	White	<input type="checkbox"/>	RC410	1SNA229201R1700	5	5.20
W (x100)	White	<input type="checkbox"/>	RC410	1SNA229202R1000	5	5.20
X (x100)	White	<input type="checkbox"/>	RC410	1SNA229203R1100	5	5.20
Y (x100)	White	<input type="checkbox"/>	RC410	1SNA229204R1200	5	5.20
Z (x100)	White	<input type="checkbox"/>	RC410	1SNA229205R1300	5	5.20

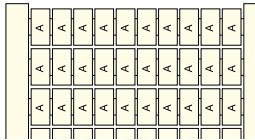

RC510 terminal block markers

Pre-printed markers for SNA and Solution series

5 mm 0.197 in spacing - horizontal mounting

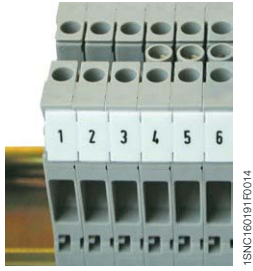

Horizontal terminal block assembly

Description

- Save printing time with our large pre-printed card offer with pre-printed numbers, letters or symbols,
- To be used to mark screw clamp, spring clamp, ADO System® and screw clamp pluggable (side marking) terminal blocks from the SNA and Solution series.

Main technical data

Material	Flammability
Polyamide	V2

Ordering details

Description	Color	Type	Part Number	Pkg card	Weight (1 card) g
-------------	-------	------	-------------	----------	-------------------

Card with 100 markers, ascending order repeated 10 times

0->9 (x10)	White	<input type="checkbox"/>	RC510	1SNA231001R2400	5	5.50
1->10 (x10)	White	<input type="checkbox"/>	RC510	1SNA231002R2500	5	5.50
11->20 (x10)	White	<input type="checkbox"/>	RC510	1SNA231003R2600	5	5.50
21->30 (x10)	White	<input type="checkbox"/>	RC510	1SNA231004R2700	5	5.50
31->40 (x10)	White	<input type="checkbox"/>	RC510	1SNA231005R2000	5	5.50
41->50 (x10)	White	<input type="checkbox"/>	RC510	1SNA231006R2100	5	5.50
51->60 (x10)	White	<input type="checkbox"/>	RC510	1SNA231007R2200	5	5.50
61->70 (x10)	White	<input type="checkbox"/>	RC510	1SNA231008R0300	5	5.50
71->80 (x10)	White	<input type="checkbox"/>	RC510	1SNA231009R0400	5	5.50
81->90 (x10)	White	<input type="checkbox"/>	RC510	1SNA231010R2000	5	5.50
91->100 (x10)	White	<input type="checkbox"/>	RC510	1SNA231011R1500	5	5.50
101->110 (x10)	White	<input type="checkbox"/>	RC510	1SNA231012R1600	5	5.50
111->120 (x10)	White	<input type="checkbox"/>	RC510	1SNA231013R1700	5	5.50
121->130 (x10)	White	<input type="checkbox"/>	RC510	1SNA231014R1000	5	5.50
131->140 (x10)	White	<input type="checkbox"/>	RC510	1SNA231015R1100	5	5.50
141->150 (x10)	White	<input type="checkbox"/>	RC510	1SNA231016R1200	5	5.50
151->160 (x10)	White	<input type="checkbox"/>	RC510	1SNA231017R1300	5	5.50
161->170 (x10)	White	<input type="checkbox"/>	RC510	1SNA231018R2400	5	5.50
171->180 (x10)	White	<input type="checkbox"/>	RC510	1SNA231019R2500	5	5.50
181->190 (x10)	White	<input type="checkbox"/>	RC510	1SNA231020R2200	5	5.50
191->200 (x10)	White	<input type="checkbox"/>	RC510	1SNA231021R1700	5	5.50

Card with 100 markers, ascending order

1->100	White	<input type="checkbox"/>	RC510	1SNA231030R2400	5	5.50
101->200	White	<input type="checkbox"/>	RC510	1SNA231031R1100	5	5.50
201->300	White	<input type="checkbox"/>	RC510	1SNA231032R1200	5	5.50
301->400	White	<input type="checkbox"/>	RC510	1SNA231033R1300	5	5.50
401->500	White	<input type="checkbox"/>	RC510	1SNA231034R1400	5	5.50
501->600	White	<input type="checkbox"/>	RC510	1SNA231035R1500	5	5.50
601->700	White	<input type="checkbox"/>	RC510	1SNA231036R1600	5	5.50
701->800	White	<input type="checkbox"/>	RC510	1SNA231037R1700	5	5.50
801->900	White	<input type="checkbox"/>	RC510	1SNA231038R2000	5	5.50
901->1000	White	<input type="checkbox"/>	RC510	1SNA231039R2100	5	5.50

Card with 100 markers, repeated identical numbers

0 (x100)	White	<input type="checkbox"/>	RC510	1SNA231210R0500	5	5.50
1 (x100)	White	<input type="checkbox"/>	RC510	1SNA231211R2200	5	5.50
2 (x100)	White	<input type="checkbox"/>	RC510	1SNA231212R2300	5	5.50
3 (x100)	White	<input type="checkbox"/>	RC510	1SNA231213R2400	5	5.50
4 (x100)	White	<input type="checkbox"/>	RC510	1SNA231214R2500	5	5.50
5 (x100)	White	<input type="checkbox"/>	RC510	1SNA231215R2600	5	5.50
6 (x100) / 9 (x100)	White	<input type="checkbox"/>	RC510	1SNA231216R2700	5	5.50
7 (x100)	White	<input type="checkbox"/>	RC510	1SNA231217R2000	5	5.50
8 (x100)	White	<input type="checkbox"/>	RC510	1SNA231218R0100	5	5.50
10 (x100)	White	<input type="checkbox"/>	RC510	1SNA231220R0700	5	5.50
11 (x100)	White	<input type="checkbox"/>	RC510	1SNA231221R2400	5	5.50
12 (x100)	White	<input type="checkbox"/>	RC510	1SNA231222R2500	5	5.50
13 (x100)	White	<input type="checkbox"/>	RC510	1SNA231223R2600	5	5.50
14 (x100)	White	<input type="checkbox"/>	RC510	1SNA231224R2700	5	5.50
15 (x100)	White	<input type="checkbox"/>	RC510	1SNA231225R2000	5	5.50
16 (x100)	White	<input type="checkbox"/>	RC510	1SNA231226R2100	5	5.50
17 (x100)	White	<input type="checkbox"/>	RC510	1SNA231227R2200	5	5.50
18 (x100)	White	<input type="checkbox"/>	RC510	1SNA231228R0300	5	5.50
19 (x100)	White	<input type="checkbox"/>	RC510	1SNA231229R0400	5	5.50
20 (x100)	White	<input type="checkbox"/>	RC510	1SNA231230R0100	5	5.50

Continue on next page →

RC510 terminal block markers

Pre-printed markers for SNA and Solution series

5 mm 0.197 in spacing - horizontal mounting

Ordering details

Description	Color	Type	Part Number	Pkg card	Weight (1 card) g
-------------	-------	------	-------------	-------------	----------------------

← Continuation of previous page

Card with 100 markers, repeated identical letters



A (x100)	White	<input type="checkbox"/>	RC510	1SNA231150R0100	5	5.50
B (x100)	White	<input type="checkbox"/>	RC510	1SNA231151R2600	5	5.50
C (x100)	White	<input type="checkbox"/>	RC510	1SNA231152R2700	5	5.50
D (x100)	White	<input type="checkbox"/>	RC510	1SNA231153R2000	5	5.50
E (x100)	White	<input type="checkbox"/>	RC510	1SNA231154R2100	5	5.50
F (x100)	White	<input type="checkbox"/>	RC510	1SNA231155R2200	5	5.50
G (x100)	White	<input type="checkbox"/>	RC510	1SNA231156R2300	5	5.50
H (x100)	White	<input type="checkbox"/>	RC510	1SNA231157R2400	5	5.50
I (x100)	White	<input type="checkbox"/>	RC510	1SNA231158R0500	5	5.50
J (x100)	White	<input type="checkbox"/>	RC510	1SNA231159R0600	5	5.50
K (x100)	White	<input type="checkbox"/>	RC510	1SNA231160R0300	5	5.50
L (x100)	White	<input type="checkbox"/>	RC510	1SNA231161R2000	5	5.50
M (x100)	White	<input type="checkbox"/>	RC510	1SNA231162R2100	5	5.50
N (x100)	White	<input type="checkbox"/>	RC510	1SNA231163R2200	5	5.50
O (x100)	White	<input type="checkbox"/>	RC510	1SNA231164R2300	5	5.50
P (x100)	White	<input type="checkbox"/>	RC510	1SNA231165R2400	5	5.50
Q (x100)	White	<input type="checkbox"/>	RC510	1SNA231166R2500	5	5.50
R (x100)	White	<input type="checkbox"/>	RC510	1SNA231167R2600	5	5.50
S (x100)	White	<input type="checkbox"/>	RC510	1SNA231168R0700	5	5.50
T (x100)	White	<input type="checkbox"/>	RC510	1SNA231169R0000	5	5.50
U (x100)	White	<input type="checkbox"/>	RC510	1SNA231170R0500	5	5.50
V (x100)	White	<input type="checkbox"/>	RC510	1SNA231171R2200	5	5.50
W (x100)	White	<input type="checkbox"/>	RC510	1SNA231172R2300	5	5.50
X (x100)	White	<input type="checkbox"/>	RC510	1SNA231173R2400	5	5.50
Y (x100)	White	<input type="checkbox"/>	RC510	1SNA231174R2500	5	5.50
Z (x100)	White	<input type="checkbox"/>	RC510	1SNA231175R2600	5	5.50

Card with 100 markers, repeated identical symbols

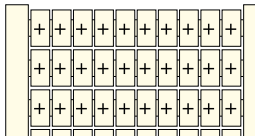

+ (x100)	White	<input type="checkbox"/>	RC510	1SNA231111R1600	5	5.50
- (x100)	White	<input type="checkbox"/>	RC510	1SNA231112R1700	5	5.50
= (x100)	White	<input type="checkbox"/>	RC510	1SNA231113R1000	5	5.50
~ (x100)	White	<input type="checkbox"/>	RC510	1SNA231114R1100	5	5.50
⏚ (x100)	White	<input type="checkbox"/>	RC510	1SNA231115R1200	5	5.50

Card with 100 markers, 5 different symbols repeated 20 times

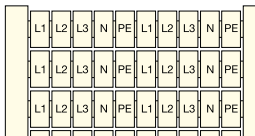

L1-L2-L3-N-PE (x20)	White	<input type="checkbox"/>	RC510	1SNA231131R1200	5	5.50
---------------------	-------	--------------------------	-------	-----------------	---	------

Card with 100 markers, repeated identical symbols



L1 (x100)	White	<input type="checkbox"/>	RC510	1SNA231116R1300	5	5.50
L2 (x100)	White	<input type="checkbox"/>	RC510	1SNA231117R1400	5	5.50
L3 (x100)	White	<input type="checkbox"/>	RC510	1SNA231118R2500	5	5.50
PE (x100)	White	<input type="checkbox"/>	RC510	1SNA231119R2600	5	5.50

RC510 terminal block markers

Pre-printed markers for SNA and Solution series

5 mm 0.197 in spacing - vertical mounting



Vertical terminal block assembly

Description

- Save printing time with our large pre-printed card offer with pre-printed numbers, letters or symbols,
- To be used to mark screw clamp, spring clamp, ADO System® and screw clamp pluggable (side marking) terminal blocks from the SNA and Solution series.

Main technical data

Material	Flammability
Polyamide	V2

Ordering details

Description	Color	Type	Part Number	Pkg card	Weight (1 card) g
-------------	-------	------	-------------	----------	-------------------

Card with 100 markers, ascending order repeated 10 times

0->9 (x10)	White	<input type="checkbox"/>	RC510	1SNA231040R0600	5	5.50
1->10 (x10)	White	<input type="checkbox"/>	RC510	1SNA231041R2300	5	5.50
11->20 (x10)	White	<input type="checkbox"/>	RC510	1SNA231042R2400	5	5.50
21->30 (x10)	White	<input type="checkbox"/>	RC510	1SNA231043R2500	5	5.50
31->40 (x10)	White	<input type="checkbox"/>	RC510	1SNA231044R2600	5	5.50
41->50 (x10)	White	<input type="checkbox"/>	RC510	1SNA231045R2700	5	5.50
51->60 (x10)	White	<input type="checkbox"/>	RC510	1SNA231046R2000	5	5.50
61->70 (x10)	White	<input type="checkbox"/>	RC510	1SNA231047R2100	5	5.50
71->80 (x10)	White	<input type="checkbox"/>	RC510	1SNA231048R0200	5	5.50
81->90 (x10)	White	<input type="checkbox"/>	RC510	1SNA231049R0300	5	5.50
91->100 (x10)	White	<input type="checkbox"/>	RC510	1SNA231050R0000	5	5.50
101->110 (x10)	White	<input type="checkbox"/>	RC510	1SNA231051R2500	5	5.50
111->120 (x10)	White	<input type="checkbox"/>	RC510	1SNA231052R2600	5	5.50
121->130 (x10)	White	<input type="checkbox"/>	RC510	1SNA231053R2700	5	5.50
131->140 (x10)	White	<input type="checkbox"/>	RC510	1SNA231054R2000	5	5.50
141->150 (x10)	White	<input type="checkbox"/>	RC510	1SNA231055R2100	5	5.50
151->160 (x10)	White	<input type="checkbox"/>	RC510	1SNA231056R2200	5	5.50
161->170 (x10)	White	<input type="checkbox"/>	RC510	1SNA231057R2300	5	5.50
171->180 (x10)	White	<input type="checkbox"/>	RC510	1SNA231058R0400	5	5.50
181->190 (x10)	White	<input type="checkbox"/>	RC510	1SNA231059R0500	5	5.50
191->200 (x10)	White	<input type="checkbox"/>	RC510	1SNA231072R2200	5	5.50

Card with 100 markers, ascending order

1->100	White	<input type="checkbox"/>	RC510	1SNA231060R0200	5	5.50
101->200	White	<input type="checkbox"/>	RC510	1SNA231061R2700	5	5.50
201->300	White	<input type="checkbox"/>	RC510	1SNA231062R2000	5	5.50
301->400	White	<input type="checkbox"/>	RC510	1SNA231063R2100	5	5.50
401->500	White	<input type="checkbox"/>	RC510	1SNA231064R2200	5	5.50
501->600	White	<input type="checkbox"/>	RC510	1SNA231065R2300	5	5.50
601->700	White	<input type="checkbox"/>	RC510	1SNA231066R2400	5	5.50
701->800	White	<input type="checkbox"/>	RC510	1SNA231067R2500	5	5.50
801->900	White	<input type="checkbox"/>	RC510	1SNA231068R0600	5	5.50
901->1000	White	<input type="checkbox"/>	RC510	1SNA231069R0700	5	5.50

Card with 100 markers, alternate odd/even numbers for double deck terminal blocks

1->20 alternate odd/even	White	<input type="checkbox"/>	RC510	1SNA231133R1400	5	5.50
21->40 alternate odd/even	White	<input type="checkbox"/>	RC510	1SNA231134R1500	5	5.50
41->60 alternate odd/even	White	<input type="checkbox"/>	RC510	1SNA231135R1600	5	5.50
61->80 alternate odd/even	White	<input type="checkbox"/>	RC510	1SNA231136R1700	5	5.50
81->100 alternate odd/even	White	<input type="checkbox"/>	RC510	1SNA231137R1000	5	5.50

Continue on next page →

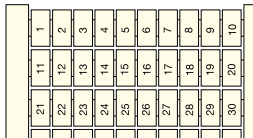
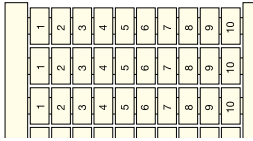

RC510 terminal block markers

Pre-printed markers for SNA and Solution series

5 mm 0.197 in spacing - vertical mounting

Ordering details

Description	Color	Type	Part Number	Pkg card	Weight (1 card) g
-------------	-------	------	-------------	-------------	----------------------

← Continuation of previous page

Card with 100 markers, repeated identical letters

A (x100)	White	<input type="checkbox"/>	RC510	1SNA231180R2000	5	5.50
B (x100)	White	<input type="checkbox"/>	RC510	1SNA231181R1500	5	5.50
C (x100)	White	<input type="checkbox"/>	RC510	1SNA231182R1600	5	5.50
D (x100)	White	<input type="checkbox"/>	RC510	1SNA231183R1700	5	5.50
E (x100)	White	<input type="checkbox"/>	RC510	1SNA231184R1000	5	5.50
F (x100)	White	<input type="checkbox"/>	RC510	1SNA231185R1100	5	5.50
G (x100)	White	<input type="checkbox"/>	RC510	1SNA231186R1200	5	5.50
H (x100)	White	<input type="checkbox"/>	RC510	1SNA231187R1300	5	5.50
I (x100)	White	<input type="checkbox"/>	RC510	1SNA231188R2400	5	5.50
J (x100)	White	<input type="checkbox"/>	RC510	1SNA231189R2500	5	5.50
K (x100)	White	<input type="checkbox"/>	RC510	1SNA231190R2200	5	5.50
L (x100)	White	<input type="checkbox"/>	RC510	1SNA231191R1700	5	5.50
M (x100)	White	<input type="checkbox"/>	RC510	1SNA231192R1000	5	5.50
N (x100)	White	<input type="checkbox"/>	RC510	1SNA231193R1100	5	5.50
O (x100)	White	<input type="checkbox"/>	RC510	1SNA231194R1200	5	5.50
P (x100)	White	<input type="checkbox"/>	RC510	1SNA231195R1300	5	5.50
Q (x100)	White	<input type="checkbox"/>	RC510	1SNA231196R1400	5	5.50
R (x100)	White	<input type="checkbox"/>	RC510	1SNA231197R1500	5	5.50
S (x100)	White	<input type="checkbox"/>	RC510	1SNA231198R2600	5	5.50
T (x100)	White	<input type="checkbox"/>	RC510	1SNA231199R2700	5	5.50
U (x100)	White	<input type="checkbox"/>	RC510	1SNA231200R1400	5	5.50
V (x100)	White	<input type="checkbox"/>	RC510	1SNA231201R0100	5	5.50
W (x100)	White	<input type="checkbox"/>	RC510	1SNA231202R0200	5	5.50
X (x100)	White	<input type="checkbox"/>	RC510	1SNA231203R0300	5	5.50
Y (x100)	White	<input type="checkbox"/>	RC510	1SNA231204R0400	5	5.50
Z (x100)	White	<input type="checkbox"/>	RC510	1SNA231205R0500	5	5.50

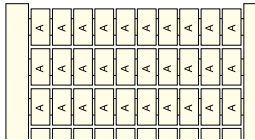

RC610 terminal block markers

Pre-printed markers for SNA and Solution series

6 mm 0.236 in spacing - horizontal mounting

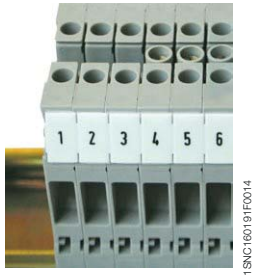

Horizontal terminal block assembly



Description

- Save printing time with our large pre-printed card offer with pre-printed numbers, letters or symbols,
- To be used to mark screw clamp, spring loaded screw clamp, spring clamp, distribution and ADO System® terminal blocks, and Miniblocks (MS..), from the SNA and Solution series.

Main technical data

Material	Flammability
Polyamide	V2

Ordering details

Description	Color	Type	Part Number	Pkg card	Weight (1 card) g
Card with 100 markers, ascending order repeated 10 times					
0->9 (x10)	White	RC610	1SNA233001R2600	5	6.80
1->10 (x10)	White	RC610	1SNA233002R2700	5	6.80
11->20 (x10)	White	RC610	1SNA233003R2000	5	6.80
21->30 (x10)	White	RC610	1SNA233004R2100	5	6.80
31->40 (x10)	White	RC610	1SNA233005R2200	5	6.80
41->50 (x10)	White	RC610	1SNA233006R2300	5	6.80
51->60 (x10)	White	RC610	1SNA233007R2400	5	6.80
61->70 (x10)	White	RC610	1SNA233008R0500	5	6.80
71->80 (x10)	White	RC610	1SNA233009R0600	5	6.80
81->90 (x10)	White	RC610	1SNA233010R2200	5	6.80
91->100 (x10)	White	RC610	1SNA233011R1700	5	6.80
101->110 (x10)	White	RC610	1SNA233012R1000	5	6.80
111->120 (x10)	White	RC610	1SNA233013R1100	5	6.80
121->130 (x10)	White	RC610	1SNA233014R1200	5	6.80
131->140 (x10)	White	RC610	1SNA233015R1300	5	6.80
141->150 (x10)	White	RC610	1SNA233016R1400	5	6.80
151->160 (x10)	White	RC610	1SNA233017R1500	5	6.80
161->170 (x10)	White	RC610	1SNA233018R2600	5	6.80
171->180 (x10)	White	RC610	1SNA233019R2700	5	6.80
181->190 (x10)	White	RC610	1SNA233020R2400	5	6.80
191->200 (x10)	White	RC610	1SNA233021R1100	5	6.80
201->210 (x10)	White	RC610	1SNA233022R1200	5	6.80
211->220 (x10)	White	RC610	1SNA233023R1300	5	6.80
221->230 (x10)	White	RC610	1SNA233024R1400	5	6.80
231->240 (x10)	White	RC610	1SNA233025R1500	5	6.80
241->250 (x10)	White	RC610	1SNA233026R1600	5	6.80
251->260 (x10)	White	RC610	1SNA233027R1700	5	6.80
261->270 (x10)	White	RC610	1SNA233028R2000	5	6.80
271->280 (x10)	White	RC610	1SNA233029R2100	5	6.80
281->290 (x10)	White	RC610	1SNA233030R2300	5	6.80
291->300 (x10)	White	RC610	1SNA233091R1000	5	6.80
301->310 (x10)	White	RC610	1SNA233092R1100	5	6.80
311->320 (x10)	White	RC610	1SNA233093R1200	5	6.80
321->330 (x10)	White	RC610	1SNA233094R1300	5	6.80
331->340 (x10)	White	RC610	1SNA233095R1400	5	6.80
341->350 (x10)	White	RC610	1SNA233096R1500	5	6.80
351->360 (x10)	White	RC610	1SNA233097R1600	5	6.80
361->370 (x10)	White	RC610	1SNA233098R2700	5	6.80
371->380 (x10)	White	RC610	1SNA233099R2000	5	6.80
381->390 (x10)	White	RC610	1SNA233100R0200	5	6.80
391->400 (x10)	White	RC610	1SNA233101R2700	5	6.80
401->410 (x10)	White	RC610	1SNA233102R2000	5	6.80
411->420 (x10)	White	RC610	1SNA233103R2100	5	6.80
421->430 (x10)	White	RC610	1SNA233104R2200	5	6.80
431->440 (x10)	White	RC610	1SNA233105R2300	5	6.80
441->450 (x10)	White	RC610	1SNA233106R2400	5	6.80
451->460 (x10)	White	RC610	1SNA233107R2500	5	6.80
461->470 (x10)	White	RC610	1SNA233108R0600	5	6.80
471->480 (x10)	White	RC610	1SNA233109R0700	5	6.80
481->490 (x10)	White	RC610	1SNA233110R2300	5	6.80
491->500 (x10)	White	RC610	1SNA233120R2500	5	6.80

Continue on next page →

RC610 terminal block markers

Pre-printed markers for SNA and Solution series

6 mm 0.236 in spacing - horizontal mounting

Ordering details

Description	Color	Type	Part Number	Pkg card	Weight (1 card) g
-------------	-------	------	-------------	-------------	----------------------

← Continuation of previous page

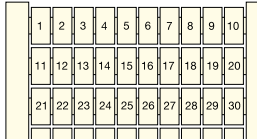

Card with 100 markers, ascending order

1->100	White	<input type="checkbox"/>	RC610	1SNA233030R2600	5	6.80
101->200	White	<input type="checkbox"/>	RC610	1SNA233031R1300	5	6.80
201->300	White	<input type="checkbox"/>	RC610	1SNA233032R1400	5	6.80
301->400	White	<input type="checkbox"/>	RC610	1SNA233033R1500	5	6.80
401->500	White	<input type="checkbox"/>	RC610	1SNA233034R1600	5	6.80
501->600	White	<input type="checkbox"/>	RC610	1SNA233035R1700	5	6.80
601->700	White	<input type="checkbox"/>	RC610	1SNA233036R1000	5	6.80
701->800	White	<input type="checkbox"/>	RC610	1SNA233074R2600	5	6.80
801->900	White	<input type="checkbox"/>	RC610	1SNA233075R2700	5	6.80
901->1000	White	<input type="checkbox"/>	RC610	1SNA233076R2000	5	6.80



Card with 100 markers, repeated identical numbers

0 (x100)	White	<input type="checkbox"/>	RC610	1SNA233201R0300	5	6.80
1 (x100)	White	<input type="checkbox"/>	RC610	1SNA233202R0400	5	6.80
2 (x100)	White	<input type="checkbox"/>	RC610	1SNA233203R0500	5	6.80
3 (x100)	White	<input type="checkbox"/>	RC610	1SNA233204R0600	5	6.80
4 (x100)	White	<input type="checkbox"/>	RC610	1SNA233205R0700	5	6.80
5 (x100)	White	<input type="checkbox"/>	RC610	1SNA233206R0000	5	6.80
6 (x100) / 9 (x100)	White	<input type="checkbox"/>	RC610	1SNA233207R0100	5	6.80
7 (x100)	White	<input type="checkbox"/>	RC610	1SNA233208R1200	5	6.80
8 (x100)	White	<input type="checkbox"/>	RC610	1SNA233209R1300	5	6.80
10 (x100)	White	<input type="checkbox"/>	RC610	1SNA233211R2400	5	6.80
11 (x100)	White	<input type="checkbox"/>	RC610	1SNA233212R2500	5	6.80
12 (x100)	White	<input type="checkbox"/>	RC610	1SNA233213R2600	5	6.80
13 (x100)	White	<input type="checkbox"/>	RC610	1SNA233214R2700	5	6.80
14 (x100)	White	<input type="checkbox"/>	RC610	1SNA233215R2000	5	6.80
15 (x100)	White	<input type="checkbox"/>	RC610	1SNA233216R2100	5	6.80
16 (x100)	White	<input type="checkbox"/>	RC610	1SNA233217R2200	5	6.80
17 (x100)	White	<input type="checkbox"/>	RC610	1SNA233218R0300	5	6.80
18 (x100)	White	<input type="checkbox"/>	RC610	1SNA233219R0400	5	6.80
19 (x100)	White	<input type="checkbox"/>	RC610	1SNA233220R0100	5	6.80
20 (x100)	White	<input type="checkbox"/>	RC610	1SNA233221R2600	5	6.80

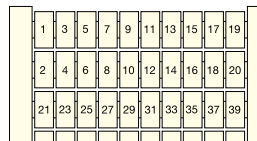

Card with 100 markers, alternate odd/even numbers for double deck terminal blocks

1->20 alternate odd/even	White	<input type="checkbox"/>	RC610	1SNA233133R1600	5	6.80
21->40 alternate odd/even	White	<input type="checkbox"/>	RC610	1SNA233134R1700	5	6.80
41->60 alternate odd/even	White	<input type="checkbox"/>	RC610	1SNA233135R1000	5	6.80
61->80 alternate odd/even	White	<input type="checkbox"/>	RC610	1SNA233136R1100	5	6.80
81->100 alternate odd/even	White	<input type="checkbox"/>	RC610	1SNA233137R1200	5	6.80



Card with 100 markers, ascending order repeated 10 times

1->9+blank (x10)	White	<input type="checkbox"/>	RC610	1SNA233142R2700	5	6.80
------------------	-------	--------------------------	-------	-----------------	---	------



Card with 100 markers, ascending order repeated twice (from 1 to 50)

1->50 (x2)	White	<input type="checkbox"/>	RC610	1SNA233141R2600	5	6.80
------------	-------	--------------------------	-------	-----------------	---	------

Continue on next page →

RC610 terminal block markers

Pre-printed markers for SNA and Solution series

6 mm 0.236 in spacing - horizontal mounting

Ordering details

Description	Color	Type	Part Number	Pkg card	Weight (1 card) g
-------------	-------	------	-------------	----------	-------------------

← Continuation of previous page

Card with 100 markers, repeated identical letters

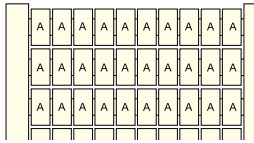

A (x100)	White	<input type="checkbox"/>	RC610	1SNA233150R0300	5	6.80
B (x100)	White	<input type="checkbox"/>	RC610	1SNA233151R2000	5	6.80
C (x100)	White	<input type="checkbox"/>	RC610	1SNA233152R2100	5	6.80
D (x100)	White	<input type="checkbox"/>	RC610	1SNA233153R2200	5	6.80
E (x100)	White	<input type="checkbox"/>	RC610	1SNA233154R2300	5	6.80
F (x100)	White	<input type="checkbox"/>	RC610	1SNA233155R2400	5	6.80
G (x100)	White	<input type="checkbox"/>	RC610	1SNA233156R2500	5	6.80
H (x100)	White	<input type="checkbox"/>	RC610	1SNA233157R2600	5	6.80
I (x100)	White	<input type="checkbox"/>	RC610	1SNA233158R0700	5	6.80
J (x100)	White	<input type="checkbox"/>	RC610	1SNA233159R0000	5	6.80
K (x100)	White	<input type="checkbox"/>	RC610	1SNA233160R0500	5	6.80
L (x100)	White	<input type="checkbox"/>	RC610	1SNA233161R2200	5	6.80
M (x100)	White	<input type="checkbox"/>	RC610	1SNA233162R2300	5	6.80
N (x100)	White	<input type="checkbox"/>	RC610	1SNA233163R2400	5	6.80
O (x100)	White	<input type="checkbox"/>	RC610	1SNA233164R2500	5	6.80
P (x100)	White	<input type="checkbox"/>	RC610	1SNA233165R2600	5	6.80
Q (x100)	White	<input type="checkbox"/>	RC610	1SNA233166R2700	5	6.80
R (x100)	White	<input type="checkbox"/>	RC610	1SNA233167R2000	5	6.80
S (x100)	White	<input type="checkbox"/>	RC610	1SNA233168R0100	5	6.80
T (x100)	White	<input type="checkbox"/>	RC610	1SNA233169R0200	5	6.80
U (x100)	White	<input type="checkbox"/>	RC610	1SNA233170R0700	5	6.80
V (x100)	White	<input type="checkbox"/>	RC610	1SNA233171R2400	5	6.80
W (x100)	White	<input type="checkbox"/>	RC610	1SNA233172R2500	5	6.80
X (x100)	White	<input type="checkbox"/>	RC610	1SNA233173R2600	5	6.80
Y (x100)	White	<input type="checkbox"/>	RC610	1SNA233174R2700	5	6.80
Z (x100)	White	<input type="checkbox"/>	RC610	1SNA233175R2000	5	6.80

Card with 100 markers, repeated identical symbols

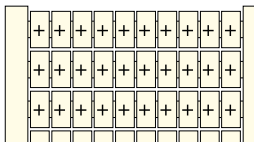

+ (x100)	White	<input type="checkbox"/>	RC610	1SNA233111R1000	5	6.80
- (x100)	White	<input type="checkbox"/>	RC610	1SNA233112R1100	5	6.80
= (x100)	White	<input type="checkbox"/>	RC610	1SNA233113R1200	5	6.80
~ (x100)	White	<input type="checkbox"/>	RC610	1SNA233114R1300	5	6.80
⏚ (x100)	White	<input type="checkbox"/>	RC610	1SNA233115R1400	5	6.80

Card with 100 markers, 5 different symbols repeated 20 times

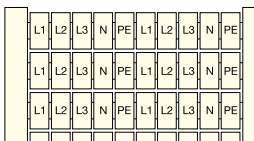

L1-L2-L3-N-PE (x20)	White	<input type="checkbox"/>	RC610	1SNA233131R1400	5	6.80
---------------------	-------	--------------------------	-------	-----------------	---	------

Card with 100 markers, repeated identical symbols



L1 (x100)	White	<input type="checkbox"/>	RC610	1SNA233116R1500	5	6.80
L2 (x100)	White	<input type="checkbox"/>	RC610	1SNA233117R1600	5	6.80
L3 (x100)	White	<input type="checkbox"/>	RC610	1SNA233118R2700	5	6.80
PE (x100)	White	<input type="checkbox"/>	RC610	1SNA233119R2000	5	6.80

Card with 100 markers, 9 different symbols repeated 10 times



U1-U2-U3-V1-V2-V3-W1-W2-W3 (x10) + U1 (x10)	White	<input type="checkbox"/>	RC610	1SNA233132R1500	5	6.80
---	-------	--------------------------	-------	-----------------	---	------

RC610 terminal block markers

Pre-printed markers for SNA and Solution series

6 mm 0.236 in spacing - vertical mounting

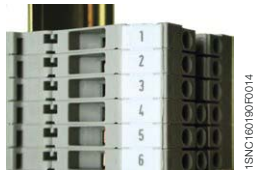

Vertical terminal block assembly

Description

- Save printing time with our large pre-printed card offer with pre-printed numbers, letters or symbols,
- To be used to mark screw clamp, spring loaded screw clamp, spring clamp, distribution and ADO System® terminal blocks, and Miniblocks (MS.), from the SNA and Solution series.

Main technical data

Material	Flammability
Polyamide	V2

Ordering details

Description	Color	Type	Part Number	Pkg card	Weight (1 card) g
-------------	-------	------	-------------	----------	-------------------

Card with 100 markers, ascending order repeated 10 times

0->9 (x10)	White	<input type="checkbox"/>	RC610	1SNA233040R0000	5	6.80
1->10 (x10)	White	<input type="checkbox"/>	RC610	1SNA233041R2500	5	6.80
11->20 (x10)	White	<input type="checkbox"/>	RC610	1SNA233042R2600	5	6.80
21->30 (x10)	White	<input type="checkbox"/>	RC610	1SNA233043R2700	5	6.80
31->40 (x10)	White	<input type="checkbox"/>	RC610	1SNA233044R2000	5	6.80
41->50 (x10)	White	<input type="checkbox"/>	RC610	1SNA233045R2100	5	6.80
51->60 (x10)	White	<input type="checkbox"/>	RC610	1SNA233046R2200	5	6.80
61->70 (x10)	White	<input type="checkbox"/>	RC610	1SNA233047R2300	5	6.80
71->80 (x10)	White	<input type="checkbox"/>	RC610	1SNA233048R0400	5	6.80
81->90 (x10)	White	<input type="checkbox"/>	RC610	1SNA233049R0500	5	6.80
91->100 (x10)	White	<input type="checkbox"/>	RC610	1SNA233050R0200	5	6.80
101->110 (x10)	White	<input type="checkbox"/>	RC610	1SNA233051R2700	5	6.80
111->120 (x10)	White	<input type="checkbox"/>	RC610	1SNA233080R2100	5	6.80
121->130 (x10)	White	<input type="checkbox"/>	RC610	1SNA233081R1600	5	6.80
131->140 (x10)	White	<input type="checkbox"/>	RC610	1SNA233082R1700	5	6.80
141->150 (x10)	White	<input type="checkbox"/>	RC610	1SNA233083R1000	5	6.80
151->160 (x10)	White	<input type="checkbox"/>	RC610	1SNA233084R1100	5	6.80
161->170 (x10)	White	<input type="checkbox"/>	RC610	1SNA233085R1200	5	6.80
171->180 (x10)	White	<input type="checkbox"/>	RC610	1SNA233086R1300	5	6.80
181->190 (x10)	White	<input type="checkbox"/>	RC610	1SNA233087R1400	5	6.80
191->200 (x10)	White	<input type="checkbox"/>	RC610	1SNA233088R2500	5	6.80

Card with 100 markers, ascending order

1->100	White	<input type="checkbox"/>	RC610	1SNA233060R0400	5	6.80
101->200	White	<input type="checkbox"/>	RC610	1SNA233061R2100	5	6.80
201->300	White	<input type="checkbox"/>	RC610	1SNA233062R2200	5	6.80
301->400	White	<input type="checkbox"/>	RC610	1SNA233063R2300	5	6.80
401->500	White	<input type="checkbox"/>	RC610	1SNA233064R2400	5	6.80
501->600	White	<input type="checkbox"/>	RC610	1SNA233065R2500	5	6.80
601->700	White	<input type="checkbox"/>	RC610	1SNA233066R2600	5	6.80
701->800	White	<input type="checkbox"/>	RC610	1SNA233067R2700	5	6.80
801->900	White	<input type="checkbox"/>	RC610	1SNA233068R0000	5	6.80
901->1000	White	<input type="checkbox"/>	RC610	1SNA233069R0100	5	6.80

Card with 100 markers, repeated identical numbers

0 (x100)	White	<input type="checkbox"/>	RC610	1SNA233240R1500	5	6.80
1 (x100)	White	<input type="checkbox"/>	RC610	1SNA233241R0200	5	6.80
2 (x100)	White	<input type="checkbox"/>	RC610	1SNA233242R0300	5	6.80
3 (x100)	White	<input type="checkbox"/>	RC610	1SNA233243R0400	5	6.80
4 (x100)	White	<input type="checkbox"/>	RC610	1SNA233244R0500	5	6.80
5 (x100)	White	<input type="checkbox"/>	RC610	1SNA233245R0600	5	6.80
6 (x100) / 9 (x100)	White	<input type="checkbox"/>	RC610	1SNA233246R0700	5	6.80
7 (x100)	White	<input type="checkbox"/>	RC610	1SNA233247R0000	5	6.80
8 (x100)	White	<input type="checkbox"/>	RC610	1SNA233248R1100	5	6.80
10 (x100)	White	<input type="checkbox"/>	RC610	1SNA233250R1700	5	6.80
11 (x100)	White	<input type="checkbox"/>	RC610	1SNA233251R0400	5	6.80
12 (x100)	White	<input type="checkbox"/>	RC610	1SNA233252R0500	5	6.80
13 (x100)	White	<input type="checkbox"/>	RC610	1SNA233253R0600	5	6.80
14 (x100)	White	<input type="checkbox"/>	RC610	1SNA233254R0700	5	6.80
15 (x100)	White	<input type="checkbox"/>	RC610	1SNA233255R0000	5	6.80
16 (x100)	White	<input type="checkbox"/>	RC610	1SNA233256R0100	5	6.80
17 (x100)	White	<input type="checkbox"/>	RC610	1SNA233257R0200	5	6.80
18 (x100)	White	<input type="checkbox"/>	RC610	1SNA233258R1300	5	6.80
19 (x100)	White	<input type="checkbox"/>	RC610	1SNA233259R1400	5	6.80
20 (x100)	White	<input type="checkbox"/>	RC610	1SNA233260R1100	5	6.80



Continue on next page →

RC610 terminal block markers

Pre-printed markers for SNA and Solution series

6 mm 0.236 in spacing - vertical mounting

Ordering details

Description	Color	Type	Part Number	Pkg card	Weight (1 card) g
-------------	-------	------	-------------	----------	-------------------

← Continuation of previous page

Card with 100 markers, alternate odd/even numbers for double deck terminal blocks

1->20 (x100)	White	<input type="checkbox"/>	RC610	1SNA233143R2000	5	6.80
21->40 (x100)	White	<input type="checkbox"/>	RC610	1SNA233144R2100	5	6.80
41->60 (x100)	White	<input type="checkbox"/>	RC610	1SNA233145R2200	5	6.80
61->80 (x100)	White	<input type="checkbox"/>	RC610	1SNA233146R2300	5	6.80
81->100 (x100)	White	<input type="checkbox"/>	RC610	1SNA233147R2400	5	6.80

Card with 100 markers, repeated identical letters

A (x100)	White	<input type="checkbox"/>	RC610	1SNA233180R2200	5	6.80
B (x100)	White	<input type="checkbox"/>	RC610	1SNA233181R1700	5	6.80
C (x100)	White	<input type="checkbox"/>	RC610	1SNA233182R1000	5	6.80
D (x100)	White	<input type="checkbox"/>	RC610	1SNA233183R1100	5	6.80
E (x100)	White	<input type="checkbox"/>	RC610	1SNA233184R1200	5	6.80
F (x100)	White	<input type="checkbox"/>	RC610	1SNA233185R1300	5	6.80
G (x100)	White	<input type="checkbox"/>	RC610	1SNA233186R1400	5	6.80
H (x100)	White	<input type="checkbox"/>	RC610	1SNA233187R1500	5	6.80
I (x100)	White	<input type="checkbox"/>	RC610	1SNA233188R2600	5	6.80
J (x100)	White	<input type="checkbox"/>	RC610	1SNA233189R2700	5	6.80
K (x100)	White	<input type="checkbox"/>	RC610	1SNA233190R2400	5	6.80
L (x100)	White	<input type="checkbox"/>	RC610	1SNA233191R1100	5	6.80
M (x100)	White	<input type="checkbox"/>	RC610	1SNA233192R1200	5	6.80
N (x100)	White	<input type="checkbox"/>	RC610	1SNA233193R1300	5	6.80
O (x100)	White	<input type="checkbox"/>	RC610	1SNA233194R1400	5	6.80
P (x100)	White	<input type="checkbox"/>	RC610	1SNA233195R1500	5	6.80
Q (x100)	White	<input type="checkbox"/>	RC610	1SNA233196R1600	5	6.80
R (x100)	White	<input type="checkbox"/>	RC610	1SNA233197R1700	5	6.80
S (x100)	White	<input type="checkbox"/>	RC610	1SNA233198R2000	5	6.80
T (x100)	White	<input type="checkbox"/>	RC610	1SNA233199R2100	5	6.80
U (x100)	White	<input type="checkbox"/>	RC610	1SNA233200R1600	5	6.80
V (x100)	White	<input type="checkbox"/>	RC610	1SNA233235R2400	5	6.80
W (x100)	White	<input type="checkbox"/>	RC610	1SNA233236R2500	5	6.80
X (x100)	White	<input type="checkbox"/>	RC610	1SNA233237R2600	5	6.80
Y (x100)	White	<input type="checkbox"/>	RC610	1SNA233238R0700	5	6.80
Z (x100)	White	<input type="checkbox"/>	RC610	1SNA233239R0000	5	6.80

Card with 100 markers, repeated identical symbols

+24V (x100)	White	<input type="checkbox"/>	RC610	1SNA233124R1500	5	6.80
+48V (x100)	White	<input type="checkbox"/>	RC610	1SNA233125R1600	5	6.80
-24V (x100)	White	<input type="checkbox"/>	RC610	1SNA233126R1700	5	6.80
-48V (x100)	White	<input type="checkbox"/>	RC610	1SNA233127R1000	5	6.80

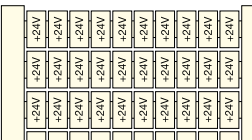
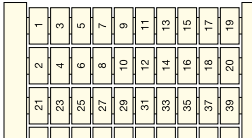

RC810 terminal block markers

Pre-printed markers for SNA and Solution series

8 mm 0.315 in spacing - horizontal mounting

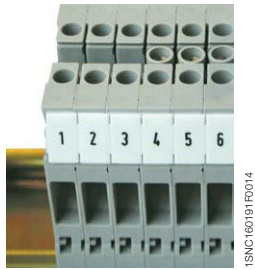

Horizontal terminal block assembly

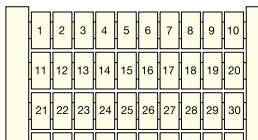

Description

- Save printing time with our large pre-printed card offer with pre-printed numbers, letters or symbols,
- To be used to mark screw clamp, spring loaded screw clamp, spring clamp, distribution, power and ADO System® terminal blocks, and screw clamp Miniblocks, from the SNA and Solution series.

Main technical data

Material	Flammability
Polyamide	V2

Ordering details

Description	Color	Type	Part Number	Pkg card	Weight (1 card) g
Card with 100 markers, ascending order repeated 10 times					
0->9 (x10)	White	<input type="checkbox"/> RC810	1SNA234001R2700	5	7.20
1->10 (x10)	White	<input type="checkbox"/> RC810	1SNA234002R2000	5	7.20
11->20 (x10)	White	<input type="checkbox"/> RC810	1SNA234003R2100	5	7.20
21->30 (x10)	White	<input type="checkbox"/> RC810	1SNA234004R2200	5	7.20
31->40 (x10)	White	<input type="checkbox"/> RC810	1SNA234005R2300	5	7.20
41->50 (x10)	White	<input type="checkbox"/> RC810	1SNA234006R2400	5	7.20
51->60 (x10)	White	<input type="checkbox"/> RC810	1SNA234007R2500	5	7.20
61->70 (x10)	White	<input type="checkbox"/> RC810	1SNA234008R0600	5	7.20
71->80 (x10)	White	<input type="checkbox"/> RC810	1SNA234009R0700	5	7.20
81->90 (x10)	White	<input type="checkbox"/> RC810	1SNA234010R2300	5	7.20
91->100 (x10)	White	<input type="checkbox"/> RC810	1SNA234011R1000	5	7.20
101->110 (x10)	White	<input type="checkbox"/> RC810	1SNA234012R1100	5	7.20
111->120 (x10)	White	<input type="checkbox"/> RC810	1SNA234013R1200	5	7.20
121->130 (x10)	White	<input type="checkbox"/> RC810	1SNA234014R1300	5	7.20
131->140 (x10)	White	<input type="checkbox"/> RC810	1SNA234015R1400	5	7.20
141->150 (x10)	White	<input type="checkbox"/> RC810	1SNA234016R1500	5	7.20
151->160 (x10)	White	<input type="checkbox"/> RC810	1SNA234017R1600	5	7.20
161->170 (x10)	White	<input type="checkbox"/> RC810	1SNA234018R2700	5	7.20
171->180 (x10)	White	<input type="checkbox"/> RC810	1SNA234019R2000	5	7.20
181->190 (x10)	White	<input type="checkbox"/> RC810	1SNA234020R2500	5	7.20
191->200 (x10)	White	<input type="checkbox"/> RC810	1SNA234021R1200	5	7.20
Card with 100 markers, ascending order					
1->100	White	<input type="checkbox"/> RC810	1SNA234030R2700	5	7.20
101->200	White	<input type="checkbox"/> RC810	1SNA234031R1400	5	7.20
201->300	White	<input type="checkbox"/> RC810	1SNA234032R1500	5	7.20
301->400	White	<input type="checkbox"/> RC810	1SNA234033R1600	5	7.20
401->500	White	<input type="checkbox"/> RC810	1SNA234034R1700	5	7.20
501->600	White	<input type="checkbox"/> RC810	1SNA234035R1000	5	7.20
601->700	White	<input type="checkbox"/> RC810	1SNA234036R1100	5	7.20
701->800	White	<input type="checkbox"/> RC810	1SNA234037R1200	5	7.20
801->900	White	<input type="checkbox"/> RC810	1SNA234038R2300	5	7.20
901->1000	White	<input type="checkbox"/> RC810	1SNA234039R2400	5	7.20
Card with 100 markers, ascending order repeated 10 times					
1->9+blank (x10)	White	<input type="checkbox"/> RC810	1SNA234130R2000	5	7.20

Continue on next page →

RC810 terminal block markers

Pre-printed markers for SNA and Solution series

8 mm 0.315 in spacing - horizontal mounting

Description

- Save printing time with our large pre-printed card offer with pre-printed numbers, letters or symbols,
- To be used to mark screw clamp, spring loaded screw clamp, spring clamp, distribution, power and ADO System® terminal blocks, and screw clamp Miniblocks, from the SNA and Solution series.

Main technical data

Material	Flammability
Polyamide	V2

Ordering details

Description	Color	Type	Part Number	Pkg card	Weight (1 card) g
-------------	-------	------	-------------	-------------	----------------------

← Continuation of previous page

Card with 100 markers, repeated identical letters

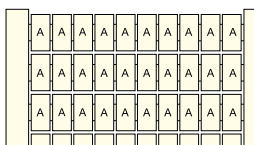

A (x100)	White	<input type="checkbox"/>	RC810	1SNA234150R0400	5	7.20
B (x100)	White	<input type="checkbox"/>	RC810	1SNA234151R2100	5	7.20
C (x100)	White	<input type="checkbox"/>	RC810	1SNA234152R2200	5	7.20
D (x100)	White	<input type="checkbox"/>	RC810	1SNA234153R2300	5	7.20
E (x100)	White	<input type="checkbox"/>	RC810	1SNA234154R2400	5	7.20
F (x100)	White	<input type="checkbox"/>	RC810	1SNA234155R2500	5	7.20
G (x100)	White	<input type="checkbox"/>	RC810	1SNA234156R2600	5	7.20
H (x100)	White	<input type="checkbox"/>	RC810	1SNA234157R2700	5	7.20
I (x100)	White	<input type="checkbox"/>	RC810	1SNA234158R0000	5	7.20
J (x100)	White	<input type="checkbox"/>	RC810	1SNA234159R0100	5	7.20
K (x100)	White	<input type="checkbox"/>	RC810	1SNA234160R0600	5	7.20
L (x100)	White	<input type="checkbox"/>	RC810	1SNA234161R2300	5	7.20
M (x100)	White	<input type="checkbox"/>	RC810	1SNA234162R2400	5	7.20
N (x100)	White	<input type="checkbox"/>	RC810	1SNA234163R2500	5	7.20
O (x100)	White	<input type="checkbox"/>	RC810	1SNA234164R2600	5	7.20
P (x100)	White	<input type="checkbox"/>	RC810	1SNA234165R2700	5	7.20
Q (x100)	White	<input type="checkbox"/>	RC810	1SNA234166R2000	5	7.20
R (x100)	White	<input type="checkbox"/>	RC810	1SNA234167R2100	5	7.20
S (x100)	White	<input type="checkbox"/>	RC810	1SNA234168R0200	5	7.20
T (x100)	White	<input type="checkbox"/>	RC810	1SNA234169R0300	5	7.20
U (x100)	White	<input type="checkbox"/>	RC810	1SNA234170R0000	5	7.20
V (x100)	White	<input type="checkbox"/>	RC810	1SNA234171R2500	5	7.20
W (x100)	White	<input type="checkbox"/>	RC810	1SNA234172R2600	5	7.20
X (x100)	White	<input type="checkbox"/>	RC810	1SNA234173R2700	5	7.20
Y (x100)	White	<input type="checkbox"/>	RC810	1SNA234174R2000	5	7.20
Z (x100)	White	<input type="checkbox"/>	RC810	1SNA234175R2100	5	7.20

Card with 100 markers, repeated identical symbols

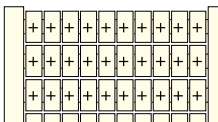

+ (x100)	White	<input type="checkbox"/>	RC810	1SNA234111R1100	5	7.20
- (x100)	White	<input type="checkbox"/>	RC810	1SNA234112R1200	5	7.20
= (x100)	White	<input type="checkbox"/>	RC810	1SNA234113R1300	5	7.20
~ (x100)	White	<input type="checkbox"/>	RC810	1SNA234114R1400	5	7.20
≡ (x100)	White	<input type="checkbox"/>	RC810	1SNA234115R1500	5	7.20

Card with 100 markers, 5 different symbols repeated 20 times

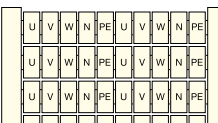

U-V-W-N-PE (x20)	White	<input type="checkbox"/>	RC810	1SNA234116R1600	5	7.20
------------------	-------	--------------------------	-------	-----------------	---	------

RC810 terminal block markers

Pre-printed markers for SNA and Solution series

8 mm 0.315 in spacing - vertical mounting

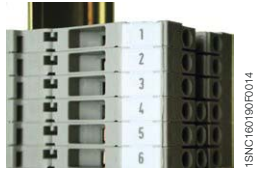

Vertical terminal block assembly

Description

- Save printing time with our large pre-printed card offer with pre-printed numbers, letters or symbols,
- To be used to mark screw clamp, spring loaded screw clamp, spring clamp, distribution, power and ADO System® terminal blocks, and screw clamp Miniblocks, from the SNA and Solution series.

Main technical data

Material	Flammability
Polyamide	V2

Ordering details

Description	Color	Type	Part Number	Pkg card	Weight (1 card) g
Card with 100 markers, ascending order repeated 10 times					
0->9 (x10)	White	RC810	1SNA234040R0100	5	7.20
1->10 (x10)	White	RC810	1SNA234041R2600	5	7.20
11->20 (x10)	White	RC810	1SNA234042R2700	5	7.20
21->30 (x10)	White	RC810	1SNA234043R2000	5	7.20
31->40 (x10)	White	RC810	1SNA234044R2100	5	7.20
41->50 (x10)	White	RC810	1SNA234045R2200	5	7.20
51->60 (x10)	White	RC810	1SNA234046R2300	5	7.20
61->70 (x10)	White	RC810	1SNA234047R2400	5	7.20
71->80 (x10)	White	RC810	1SNA234048R0500	5	7.20
81->90 (x10)	White	RC810	1SNA234049R0600	5	7.20
91->100 (x10)	White	RC810	1SNA234050R0300	5	7.20
101->110 (x10)	White	RC810	1SNA234051R2000	5	7.20
111->120 (x10)	White	RC810	1SNA234052R2100	5	7.20
121->130 (x10)	White	RC810	1SNA234053R2200	5	7.20
131->140 (x10)	White	RC810	1SNA234054R2300	5	7.20
141->150 (x10)	White	RC810	1SNA234055R2400	5	7.20
151->160 (x10)	White	RC810	1SNA234056R2500	5	7.20
161->170 (x10)	White	RC810	1SNA234057R2600	5	7.20
171->180 (x10)	White	RC810	1SNA234058R0700	5	7.20
181->190 (x10)	White	RC810	1SNA234059R0000	5	7.20
191->200 (x10)	White	RC810	1SNA234072R2500	5	7.20
Card with 100 markers, ascending order					
1->100	White	RC810	1SNA234060R0500	5	7.20
101->200	White	RC810	1SNA234061R2200	5	7.20
201->300	White	RC810	1SNA234062R2300	5	7.20
301->400	White	RC810	1SNA234063R2400	5	7.20
401->500	White	RC810	1SNA234064R2500	5	7.20
501->600	White	RC810	1SNA234065R2600	5	7.20
601->700	White	RC810	1SNA234066R2700	5	7.20
701->800	White	RC810	1SNA234067R2000	5	7.20
801->900	White	RC810	1SNA234068R0100	5	7.20
901->1000	White	RC810	1SNA234069R0200	5	7.20
Card with 100 markers, repeated identical letters					
A (x100)	White	RC810	1SNA234180R2300	5	7.20
B (x100)	White	RC810	1SNA234181R1000	5	7.20
C (x100)	White	RC810	1SNA234182R1100	5	7.20
D (x100)	White	RC810	1SNA234183R1200	5	7.20
E (x100)	White	RC810	1SNA234184R1300	5	7.20
F (x100)	White	RC810	1SNA234185R1400	5	7.20
G (x100)	White	RC810	1SNA234186R1500	5	7.20
H (x100)	White	RC810	1SNA234187R1600	5	7.20
I (x100)	White	RC810	1SNA234188R2700	5	7.20
J (x100)	White	RC810	1SNA234189R2000	5	7.20
K (x100)	White	RC810	1SNA234190R2500	5	7.20
L (x100)	White	RC810	1SNA234191R1200	5	7.20
M (x100)	White	RC810	1SNA234192R1300	5	7.20
N (x100)	White	RC810	1SNA234193R1400	5	7.20
O (x100)	White	RC810	1SNA234194R1500	5	7.20
P (x100)	White	RC810	1SNA234195R1600	5	7.20
Q (x100)	White	RC810	1SNA234196R1700	5	7.20
R (x100)	White	RC810	1SNA234197R1000	5	7.20
S (x100)	White	RC810	1SNA234198R2100	5	7.20
T (x100)	White	RC810	1SNA234199R2200	5	7.20
U (x100)	White	RC810	1SNA234200R1700	5	7.20
V (x100)	White	RC810	1SNA234201R0400	5	7.20
W (x100)	White	RC810	1SNA234202R0500	5	7.20
X (x100)	White	RC810	1SNA234203R0600	5	7.20
Y (x100)	White	RC810	1SNA234204R0700	5	7.20
Z (x100)	White	RC810	1SNA234205R0000	5	7.20

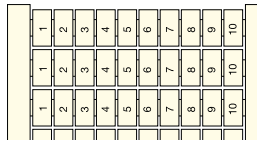

RC1010 terminal block markers

Pre-printed markers for SNA and Solution series

10 mm 0.394 in spacing - horizontal mounting



Horizontal terminal block assembly

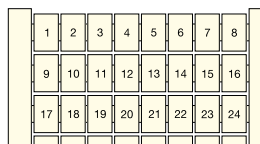

Description

- Save printing time with our large pre-printed cards offer with pre-printed numbers, letters or symbols,
- To be used to mark screw clamp, spring loaded screw clamp, spring clamp and distribution terminal blocks from the SNA and Solution series.

Main technical data

Material	Flammability
Polyamide	V2

Ordering details

Description	Color	Type	Part Number	Pkg card	Weight (1 card) g
Card with 80 markers, ascending order repeated 10 times					
0->7 (x10)	White <input type="checkbox"/>	RC1010	1SNA238001R0300	5	8.00
1->8 (x10)	White <input type="checkbox"/>	RC1010	1SNA238002R0400	5	8.00
9->16 (x10)	White <input type="checkbox"/>	RC1010	1SNA238003R0500	5	8.00
17->24 (x10)	White <input type="checkbox"/>	RC1010	1SNA238004R0600	5	8.00
25->32 (x10)	White <input type="checkbox"/>	RC1010	1SNA238005R0700	5	8.00
33->40 (x10)	White <input type="checkbox"/>	RC1010	1SNA238006R0800	5	8.00
41->48 (x10)	White <input type="checkbox"/>	RC1010	1SNA238007R0900	5	8.00
49->56 (x10)	White <input type="checkbox"/>	RC1010	1SNA238008R1000	5	8.00
57->64 (x10)	White <input type="checkbox"/>	RC1010	1SNA238009R1100	5	8.00
65->72 (x10)	White <input type="checkbox"/>	RC1010	1SNA238010R1200	5	8.00
73->80 (x10)	White <input type="checkbox"/>	RC1010	1SNA238011R1300	5	8.00
81->88 (x10)	White <input type="checkbox"/>	RC1010	1SNA238012R1400	5	8.00
89->96 (x10)	White <input type="checkbox"/>	RC1010	1SNA238013R1500	5	8.00
97->104 (x10)	White <input type="checkbox"/>	RC1010	1SNA238014R1600	5	8.00
105->112 (x10)	White <input type="checkbox"/>	RC1010	1SNA238015R1700	5	8.00
113->120 (x10)	White <input type="checkbox"/>	RC1010	1SNA238016R1800	5	8.00
121->128 (x10)	White <input type="checkbox"/>	RC1010	1SNA238017R1900	5	8.00
129->136 (x10)	White <input type="checkbox"/>	RC1010	1SNA238018R2000	5	8.00
137->144 (x10)	White <input type="checkbox"/>	RC1010	1SNA238019R2100	5	8.00
145->152 (x10)	White <input type="checkbox"/>	RC1010	1SNA238020R2200	5	8.00
153->160 (x10)	White <input type="checkbox"/>	RC1010	1SNA238021R2300	5	8.00
161->168 (x10)	White <input type="checkbox"/>	RC1010	1SNA238022R2400	5	8.00
169->176 (x10)	White <input type="checkbox"/>	RC1010	1SNA238023R2500	5	8.00
177->184 (x10)	White <input type="checkbox"/>	RC1010	1SNA238024R2600	5	8.00
185->192 (x10)	White <input type="checkbox"/>	RC1010	1SNA238025R2700	5	8.00
193->200 (x10)	White <input type="checkbox"/>	RC1010	1SNA238026R2800	5	8.00
Card with 80 markers, ascending order					
1->80	White <input type="checkbox"/>	RC1010	1SNA238030R0300	5	8.00
81->160	White <input type="checkbox"/>	RC1010	1SNA238031R0400	5	8.00
161->240	White <input type="checkbox"/>	RC1010	1SNA238032R0500	5	8.00
241->320	White <input type="checkbox"/>	RC1010	1SNA238033R0600	5	8.00
321->400	White <input type="checkbox"/>	RC1010	1SNA238034R0700	5	8.00
401->480	White <input type="checkbox"/>	RC1010	1SNA238035R0800	5	8.00
481->560	White <input type="checkbox"/>	RC1010	1SNA238036R0900	5	8.00
561->640	White <input type="checkbox"/>	RC1010	1SNA238037R1000	5	8.00
641->720	White <input type="checkbox"/>	RC1010	1SNA238038R1100	5	8.00
721->800	White <input type="checkbox"/>	RC1010	1SNA238039R1200	5	8.00
801->880	White <input type="checkbox"/>	RC1010	1SNA238040R1300	5	8.00
881->960	White <input type="checkbox"/>	RC1010	1SNA238041R1400	5	8.00

RC1010 terminal block markers

Pre-printed markers for SNA and Solution series

10 mm 0.394 in spacing - vertical mounting

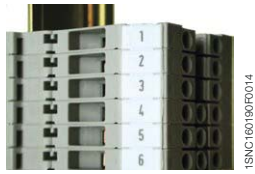

Vertical terminal block assembly

Description

- Save printing time with our large pre-printed cards offer with pre-printed numbers, letters or symbols,
- To be used to mark screw clamp, spring loaded screw clamp, spring clamp and distribution terminal blocks from the SNA and Solution series.

Main technical data

Material	Flammability
Polyamide	V2

Ordering details

Description	Color	Type	Part Number	Pkg card	Weight (1 card) g
-------------	-------	------	-------------	-------------	----------------------

Card with 80 markers, ascending order repeated 10 times

0->7 (x10)	White	<input type="checkbox"/>	RC1010	1SNA238050R1700	5	8.00
1->8 (x10)	White	<input type="checkbox"/>	RC1010	1SNA238051R0400	5	8.00
9->16 (x10)	White	<input type="checkbox"/>	RC1010	1SNA238052R0500	5	8.00
17->24 (x10)	White	<input type="checkbox"/>	RC1010	1SNA238053R0600	5	8.00
25->32 (x10)	White	<input type="checkbox"/>	RC1010	1SNA238054R0700	5	8.00
33->40 (x10)	White	<input type="checkbox"/>	RC1010	1SNA238055R0000	5	8.00
41->48 (x10)	White	<input type="checkbox"/>	RC1010	1SNA238056R0100	5	8.00
49->56 (x10)	White	<input type="checkbox"/>	RC1010	1SNA238057R0200	5	8.00
57->64 (x10)	White	<input type="checkbox"/>	RC1010	1SNA238058R1300	5	8.00
65->72 (x10)	White	<input type="checkbox"/>	RC1010	1SNA238059R1400	5	8.00
73->80 (x10)	White	<input type="checkbox"/>	RC1010	1SNA238060R1100	5	8.00
81->88 (x10)	White	<input type="checkbox"/>	RC1010	1SNA238061R0600	5	8.00
89->96 (x10)	White	<input type="checkbox"/>	RC1010	1SNA238062R0700	5	8.00
97->104 (x10)	White	<input type="checkbox"/>	RC1010	1SNA238063R0000	5	8.00
105->112 (x10)	White	<input type="checkbox"/>	RC1010	1SNA238064R0100	5	8.00
113->120 (x10)	White	<input type="checkbox"/>	RC1010	1SNA238065R0200	5	8.00
121->128 (x10)	White	<input type="checkbox"/>	RC1010	1SNA238066R0300	5	8.00
129->136 (x10)	White	<input type="checkbox"/>	RC1010	1SNA238067R0400	5	8.00
137->144 (x10)	White	<input type="checkbox"/>	RC1010	1SNA238068R1500	5	8.00
145->152 (x10)	White	<input type="checkbox"/>	RC1010	1SNA238069R1600	5	8.00
153->160 (x10)	White	<input type="checkbox"/>	RC1010	1SNA238070R1300	5	8.00
161->168 (x10)	White	<input type="checkbox"/>	RC1010	1SNA238071R0000	5	8.00
169->176 (x10)	White	<input type="checkbox"/>	RC1010	1SNA238072R0100	5	8.00
177->184 (x10)	White	<input type="checkbox"/>	RC1010	1SNA238073R0200	5	8.00
185->192 (x10)	White	<input type="checkbox"/>	RC1010	1SNA238074R0300	5	8.00
193->200 (x10)	White	<input type="checkbox"/>	RC1010	1SNA238075R0400	5	8.00

Card with 80 markers, ascending order

1->80	White	<input type="checkbox"/>	RC1010	1SNA238080R0600	5	8.00
81->160	White	<input type="checkbox"/>	RC1010	1SNA238081R2300	5	8.00
161->240	White	<input type="checkbox"/>	RC1010	1SNA238082R2400	5	8.00
241->320	White	<input type="checkbox"/>	RC1010	1SNA238083R2500	5	8.00
321->400	White	<input type="checkbox"/>	RC1010	1SNA238084R2600	5	8.00
401->480	White	<input type="checkbox"/>	RC1010	1SNA238085R2700	5	8.00
481->560	White	<input type="checkbox"/>	RC1010	1SNA238086R2000	5	8.00
561->640	White	<input type="checkbox"/>	RC1010	1SNA238087R2100	5	8.00
641->720	White	<input type="checkbox"/>	RC1010	1SNA238088R0200	5	8.00



RC55 terminal block markers

Pre-printed markers for SNA and Solution series

5 mm 0.197 in spacing - horizontal mounting

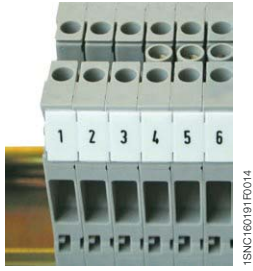

Horizontal terminal block assembly

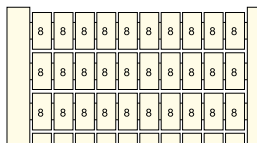
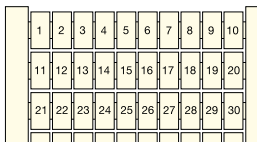

Description

- Save printing time with our large pre-printed card offer with pre-printed numbers, letters or symbols,
- To be used to mark screw clamp and spring clamp terminal blocks, and all Miniblocks, from the SNA and Solution series.

Main technical data

Material	Flammability
Polyamide	V2

Ordering details

Description	Color	Type	Part Number	Pkg card	Weight (1 card) g
-------------	-------	------	-------------	----------	-------------------

Card with 100 markers, ascending order repeated 10 times

0->9 (x10)	White	<input type="checkbox"/>	RC55	1SNA230001R0700	5	2.70
1->10 (x10)	White	<input type="checkbox"/>	RC55	1SNA230002R0000	5	2.70
11->20 (x10)	White	<input type="checkbox"/>	RC55	1SNA230003R0100	5	2.70
21->30 (x10)	White	<input type="checkbox"/>	RC55	1SNA230004R0200	5	2.70
31->40 (x10)	White	<input type="checkbox"/>	RC55	1SNA230005R0300	5	2.70
41->50 (x10)	White	<input type="checkbox"/>	RC55	1SNA230006R0400	5	2.70
51->60 (x10)	White	<input type="checkbox"/>	RC55	1SNA230007R0500	5	2.70
61->70 (x10)	White	<input type="checkbox"/>	RC55	1SNA230008R1600	5	2.70
71->80 (x10)	White	<input type="checkbox"/>	RC55	1SNA230009R1700	5	2.70
81->90 (x10)	White	<input type="checkbox"/>	RC55	1SNA230010R0300	5	2.70
91->100 (x10)	White	<input type="checkbox"/>	RC55	1SNA230011R2000	5	2.70
101->110 (x10)	White	<input type="checkbox"/>	RC55	1SNA230012R2100	5	2.70
111->120 (x10)	White	<input type="checkbox"/>	RC55	1SNA230013R2200	5	2.70
121->130 (x10)	White	<input type="checkbox"/>	RC55	1SNA230014R2300	5	2.70
131->140 (x10)	White	<input type="checkbox"/>	RC55	1SNA230015R2400	5	2.70
141->150 (x10)	White	<input type="checkbox"/>	RC55	1SNA230016R2500	5	2.70
151->160 (x10)	White	<input type="checkbox"/>	RC55	1SNA230017R2600	5	2.70
161->170 (x10)	White	<input type="checkbox"/>	RC55	1SNA230018R0700	5	2.70
171->180 (x10)	White	<input type="checkbox"/>	RC55	1SNA230019R0000	5	2.70
181->190 (x10)	White	<input type="checkbox"/>	RC55	1SNA230020R0500	5	2.70
191->200 (x10)	White	<input type="checkbox"/>	RC55	1SNA230021R2200	5	2.70

Card with 100 markers, ascending order

1->100	White	<input type="checkbox"/>	RC55	1SNA230030R0700	5	2.70
101->200	White	<input type="checkbox"/>	RC55	1SNA230031R2400	5	2.70
201->300	White	<input type="checkbox"/>	RC55	1SNA230032R2500	5	2.70
301->400	White	<input type="checkbox"/>	RC55	1SNA230033R2600	5	2.70
401->500	White	<input type="checkbox"/>	RC55	1SNA230034R2700	5	2.70
501->600	White	<input type="checkbox"/>	RC55	1SNA230035R2000	5	2.70
601->700	White	<input type="checkbox"/>	RC55	1SNA230036R2100	5	2.70
701->800	White	<input type="checkbox"/>	RC55	1SNA230037R2200	5	2.70
801->900	White	<input type="checkbox"/>	RC55	1SNA230038R0300	5	2.70
901->1000	White	<input type="checkbox"/>	RC55	1SNA230039R0400	5	2.70

Card with 100 markers, repeated identical numbers

0 (x100)	White	<input type="checkbox"/>	RC55	1SNA230240R2600	5	2.70
1 (x100)	White	<input type="checkbox"/>	RC55	1SNA230241R1300	5	2.70
2 (x100)	White	<input type="checkbox"/>	RC55	1SNA230242R1400	5	2.70
3 (x100)	White	<input type="checkbox"/>	RC55	1SNA230243R1500	5	2.70
4 (x100)	White	<input type="checkbox"/>	RC55	1SNA230244R1600	5	2.70
5 (x100)	White	<input type="checkbox"/>	RC55	1SNA230245R1700	5	2.70
6 (x100) / 9 (x100)	White	<input type="checkbox"/>	RC55	1SNA230246R1000	5	2.70
7 (x100)	White	<input type="checkbox"/>	RC55	1SNA230247R1100	5	2.70
8 (x100)	White	<input type="checkbox"/>	RC55	1SNA230248R2200	5	2.70
10 (x100)	White	<input type="checkbox"/>	RC55	1SNA230250R2000	5	2.70
11 (x100)	White	<input type="checkbox"/>	RC55	1SNA230251R1500	5	2.70
12 (x100)	White	<input type="checkbox"/>	RC55	1SNA230252R1600	5	2.70
13 (x100)	White	<input type="checkbox"/>	RC55	1SNA230253R1700	5	2.70
14 (x100)	White	<input type="checkbox"/>	RC55	1SNA230254R1000	5	2.70
15 (x100)	White	<input type="checkbox"/>	RC55	1SNA230255R1100	5	2.70
16 (x100)	White	<input type="checkbox"/>	RC55	1SNA230256R1200	5	2.70
17 (x100)	White	<input type="checkbox"/>	RC55	1SNA230257R1300	5	2.70
18 (x100)	White	<input type="checkbox"/>	RC55	1SNA230258R2400	5	2.70
19 (x100)	White	<input type="checkbox"/>	RC55	1SNA230259R2500	5	2.70
20 (x100)	White	<input type="checkbox"/>	RC55	1SNA230260R2200	5	2.70

Continue on next page →

RC55 terminal block markers

Pre-printed markers for SNA and Solution series

5 mm 0.197 in spacing - horizontal mounting

Ordering details

Description	Color	Type	Part Number	Pkg card	Weight (1 card) g
-------------	-------	------	-------------	-------------	----------------------

← Continuation of previous page

Card with 100 markers, repeated identical letters

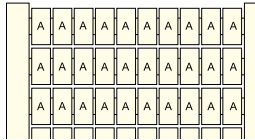

A (x100)	White	<input type="checkbox"/>	RC55	1SNA230150R1400	5	2.70
B (x100)	White	<input type="checkbox"/>	RC55	1SNA230151R0100	5	2.70
C (x100)	White	<input type="checkbox"/>	RC55	1SNA230152R0200	5	2.70
D (x100)	White	<input type="checkbox"/>	RC55	1SNA230153R0300	5	2.70
E (x100)	White	<input type="checkbox"/>	RC55	1SNA230154R0400	5	2.70
F (x100)	White	<input type="checkbox"/>	RC55	1SNA230155R0500	5	2.70
G (x100)	White	<input type="checkbox"/>	RC55	1SNA230156R0600	5	2.70
H (x100)	White	<input type="checkbox"/>	RC55	1SNA230157R0700	5	2.70
I (x100)	White	<input type="checkbox"/>	RC55	1SNA230158R1000	5	2.70
J (x100)	White	<input type="checkbox"/>	RC55	1SNA230159R1100	5	2.70
K (x100)	White	<input type="checkbox"/>	RC55	1SNA230160R1600	5	2.70
L (x100)	White	<input type="checkbox"/>	RC55	1SNA230161R0300	5	2.70
M (x100)	White	<input type="checkbox"/>	RC55	1SNA230162R0400	5	2.70
N (x100)	White	<input type="checkbox"/>	RC55	1SNA230163R0500	5	2.70
O (x100)	White	<input type="checkbox"/>	RC55	1SNA230164R0600	5	2.70
P (x100)	White	<input type="checkbox"/>	RC55	1SNA230165R0700	5	2.70
Q (x100)	White	<input type="checkbox"/>	RC55	1SNA230166R0000	5	2.70
R (x100)	White	<input type="checkbox"/>	RC55	1SNA230167R0100	5	2.70
S (x100)	White	<input type="checkbox"/>	RC55	1SNA230168R1200	5	2.70
T (x100)	White	<input type="checkbox"/>	RC55	1SNA230169R1300	5	2.70
U (x100)	White	<input type="checkbox"/>	RC55	1SNA230170R1000	5	2.70
V (x100)	White	<input type="checkbox"/>	RC55	1SNA230171R0500	5	2.70
W (x100)	White	<input type="checkbox"/>	RC55	1SNA230172R0600	5	2.70
X (x100)	White	<input type="checkbox"/>	RC55	1SNA230173R0700	5	2.70
Y (x100)	White	<input type="checkbox"/>	RC55	1SNA230174R0000	5	2.70
Z (x100)	White	<input type="checkbox"/>	RC55	1SNA230175R0100	5	2.70

Card with 100 markers, repeated identical symbols



+ (x100)	White	<input type="checkbox"/>	RC55	1SNA230111R2100	5	2.70
- (x100)	White	<input type="checkbox"/>	RC55	1SNA230112R2200	5	2.70
= (x100)	White	<input type="checkbox"/>	RC55	1SNA230113R2300	5	2.70
~ (x100)	White	<input type="checkbox"/>	RC55	1SNA230114R2400	5	2.70
≡ (x100)	White	<input type="checkbox"/>	RC55	1SNA230115R2500	5	2.70

Card with 100 markers, 5 different symbols repeated 20 times

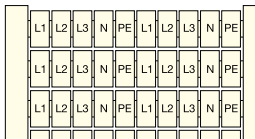

L1-L2-L3-N-PE (x20)	White	<input type="checkbox"/>	RC55	1SNA230131R2500	5	2.70
---------------------	-------	--------------------------	------	-----------------	---	------

Card with 100 markers, repeated identical symbols



L1 (x100)	White	<input type="checkbox"/>	RC55	1SNA230116R2600	5	2.70
L2 (x100)	White	<input type="checkbox"/>	RC55	1SNA230117R2700	5	2.70
L3 (x100)	White	<input type="checkbox"/>	RC55	1SNA230118R0000	5	2.70
PE (x100)	White	<input type="checkbox"/>	RC55	1SNA230119R0100	5	2.70

RC55 terminal block markers

Pre-printed markers for SNA and Solution series

5 mm 0.197 in spacing - vertical mounting



Vertical terminal block assembly

Description

- Save printing time with our large pre-printed card offer with pre-printed numbers, letters or symbols,
- To be used to mark screw clamp and spring clamp terminal blocks, and all Miniblocks, from the SNA and Solution series.

Main technical data

Material	Flammability
Polyamide	V2

Ordering details

Description	Color	Type	Part Number	Pkg card	Weight (1 card) g
Card with 100 markers, ascending order repeated 10 times					
0->9 (x10)	White	<input type="checkbox"/> RC55	1SNA230040R1100	5	2.70
1->10 (x10)	White	<input type="checkbox"/> RC55	1SNA230041R0600	5	2.70
11->20 (x10)	White	<input type="checkbox"/> RC55	1SNA230042R0700	5	2.70
21->30 (x10)	White	<input type="checkbox"/> RC55	1SNA230043R0000	5	2.70
31->40 (x10)	White	<input type="checkbox"/> RC55	1SNA230044R0100	5	2.70
41->50 (x10)	White	<input type="checkbox"/> RC55	1SNA230045R0200	5	2.70
51->60 (x10)	White	<input type="checkbox"/> RC55	1SNA230046R0300	5	2.70
61->70 (x10)	White	<input type="checkbox"/> RC55	1SNA230047R0400	5	2.70
71->80 (x10)	White	<input type="checkbox"/> RC55	1SNA230048R1500	5	2.70
81->90 (x10)	White	<input type="checkbox"/> RC55	1SNA230049R1600	5	2.70
91->100 (x10)	White	<input type="checkbox"/> RC55	1SNA230050R1300	5	2.70
101->110 (x10)	White	<input type="checkbox"/> RC55	1SNA230051R0000	5	2.70
111->120 (x10)	White	<input type="checkbox"/> RC55	1SNA230052R0100	5	2.70
121->130 (x10)	White	<input type="checkbox"/> RC55	1SNA230053R0200	5	2.70
131->140 (x10)	White	<input type="checkbox"/> RC55	1SNA230054R0300	5	2.70
141->150 (x10)	White	<input type="checkbox"/> RC55	1SNA230055R0400	5	2.70
151->160 (x10)	White	<input type="checkbox"/> RC55	1SNA230056R0500	5	2.70
161->170 (x10)	White	<input type="checkbox"/> RC55	1SNA230057R0600	5	2.70
171->180 (x10)	White	<input type="checkbox"/> RC55	1SNA230058R1700	5	2.70
181->190 (x10)	White	<input type="checkbox"/> RC55	1SNA230059R1000	5	2.70
191->200 (x10)	White	<input type="checkbox"/> RC55	1SNA230072R0500	5	2.70

Card with 100 markers, ascending order

1->100	White	<input type="checkbox"/> RC55	1SNA230060R1500	5	2.70
101->200	White	<input type="checkbox"/> RC55	1SNA230061R0200	5	2.70
201->300	White	<input type="checkbox"/> RC55	1SNA230062R0300	5	2.70
301->400	White	<input type="checkbox"/> RC55	1SNA230063R0400	5	2.70
401->500	White	<input type="checkbox"/> RC55	1SNA230064R0500	5	2.70
501->600	White	<input type="checkbox"/> RC55	1SNA230065R0600	5	2.70
601->700	White	<input type="checkbox"/> RC55	1SNA230066R0700	5	2.70
701->800	White	<input type="checkbox"/> RC55	1SNA230067R0000	5	2.70
801->900	White	<input type="checkbox"/> RC55	1SNA230068R1100	5	2.70
901->1000	White	<input type="checkbox"/> RC55	1SNA230069R1200	5	2.70

Card with 100 markers, repeated identical letters

A (x100)	White	<input type="checkbox"/> RC55	1SNA230180R0300	5	2.70
B (x100)	White	<input type="checkbox"/> RC55	1SNA230181R2000	5	2.70
C (x100)	White	<input type="checkbox"/> RC55	1SNA230182R2100	5	2.70
D (x100)	White	<input type="checkbox"/> RC55	1SNA230183R2200	5	2.70
E (x100)	White	<input type="checkbox"/> RC55	1SNA230184R2300	5	2.70
F (x100)	White	<input type="checkbox"/> RC55	1SNA230185R2400	5	2.70
G (x100)	White	<input type="checkbox"/> RC55	1SNA230186R2500	5	2.70
H (x100)	White	<input type="checkbox"/> RC55	1SNA230187R2600	5	2.70
I (x100)	White	<input type="checkbox"/> RC55	1SNA230188R0700	5	2.70
J (x100)	White	<input type="checkbox"/> RC55	1SNA230189R0000	5	2.70
K (x100)	White	<input type="checkbox"/> RC55	1SNA230190R0500	5	2.70
L (x100)	White	<input type="checkbox"/> RC55	1SNA230191R2200	5	2.70
M (x100)	White	<input type="checkbox"/> RC55	1SNA230192R2300	5	2.70
N (x100)	White	<input type="checkbox"/> RC55	1SNA230193R2400	5	2.70
O (x100)	White	<input type="checkbox"/> RC55	1SNA230194R2500	5	2.70
P (x100)	White	<input type="checkbox"/> RC55	1SNA230195R2600	5	2.70
Q (x100)	White	<input type="checkbox"/> RC55	1SNA230196R2700	5	2.70
R (x100)	White	<input type="checkbox"/> RC55	1SNA230197R2000	5	2.70
S (x100)	White	<input type="checkbox"/> RC55	1SNA230198R0100	5	2.70
T (x100)	White	<input type="checkbox"/> RC55	1SNA230199R0200	5	2.70
U (x100)	White	<input type="checkbox"/> RC55	1SNA230200R2700	5	2.70
V (x100)	White	<input type="checkbox"/> RC55	1SNA230201R1400	5	2.70
W (x100)	White	<input type="checkbox"/> RC55	1SNA230202R1500	5	2.70
X (x100)	White	<input type="checkbox"/> RC55	1SNA230203R1600	5	2.70
Y (x100)	White	<input type="checkbox"/> RC55	1SNA230204R1700	5	2.70
Z (x100)	White	<input type="checkbox"/> RC55	1SNA230205R1000	5	2.70

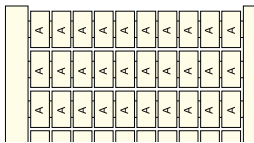
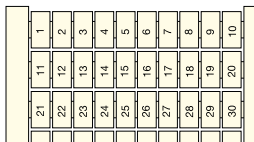
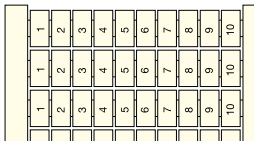

RC65 terminal block markers

Pre-printed markers for SNA and Solution series

6 mm 0.236 in spacing - horizontal mounting

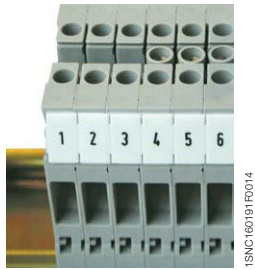

Horizontal terminal block assembly

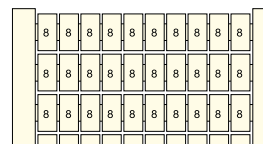
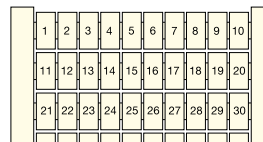

Description

- Save printing time with our large pre-printed card offer with pre-printed numbers, letters or symbols,
- To be used to mark screw clamp and spring clamp (side mounting) terminal blocks, and all Miniblocks from the SNA and Solution series.

Main technical data

Material	Flammability
Polyamide	V2

Ordering details

Description	Color	Type	Part Number	Pkg card	Weight (1 card) g
Card with 100 markers, ascending order repeated 10 times					
0->9 (x10)	White	RC65	1SNA232001R2500	5	3.50
1->10 (x10)	White	RC65	1SNA232002R2600	5	3.50
11->20 (x10)	White	RC65	1SNA232003R2700	5	3.50
21->30 (x10)	White	RC65	1SNA232004R2000	5	3.50
31->40 (x10)	White	RC65	1SNA232005R2100	5	3.50
41->50 (x10)	White	RC65	1SNA232006R2200	5	3.50
51->60 (x10)	White	RC65	1SNA232007R2300	5	3.50
61->70 (x10)	White	RC65	1SNA232008R0400	5	3.50
71->80 (x10)	White	RC65	1SNA232009R0500	5	3.50
81->90 (x10)	White	RC65	1SNA232010R2100	5	3.50
91->100 (x10)	White	RC65	1SNA232011R1600	5	3.50
101->110 (x10)	White	RC65	1SNA232012R1700	5	3.50
111->120 (x10)	White	RC65	1SNA232013R1000	5	3.50
121->130 (x10)	White	RC65	1SNA232014R1100	5	3.50
131->140 (x10)	White	RC65	1SNA232015R1200	5	3.50
141->150 (x10)	White	RC65	1SNA232016R1300	5	3.50
151->160 (x10)	White	RC65	1SNA232017R1400	5	3.50
161->170 (x10)	White	RC65	1SNA232018R2500	5	3.50
171->180 (x10)	White	RC65	1SNA232019R2600	5	3.50
181->190 (x10)	White	RC65	1SNA232020R2300	5	3.50
191->200 (x10)	White	RC65	1SNA232021R1000	5	3.50
Card with 100 markers, ascending order					
1->100	White	RC65	1SNA232030R2500	5	3.50
101->200	White	RC65	1SNA232031R1200	5	3.50
201->300	White	RC65	1SNA232032R1300	5	3.50
301->400	White	RC65	1SNA232033R1400	5	3.50
401->500	White	RC65	1SNA232034R1500	5	3.50
501->600	White	RC65	1SNA232035R1600	5	3.50
601->700	White	RC65	1SNA232036R1700	5	3.50
701->800	White	RC65	1SNA232037R1000	5	3.50
801->900	White	RC65	1SNA232038R2100	5	3.50
901->1000	White	RC65	1SNA232039R2200	5	3.50
Card with 100 markers, repeated identical numbers					
0 (x100)	White	RC65	1SNA232201R0200	5	3.50
1 (x100)	White	RC65	1SNA232202R0300	5	3.50
2 (x100)	White	RC65	1SNA232203R0400	5	3.50
3 (x100)	White	RC65	1SNA232204R0500	5	3.50
4 (x100)	White	RC65	1SNA232205R0600	5	3.50
5 (x100)	White	RC65	1SNA232206R0700	5	3.50
6 (x100) / 9 (x100)	White	RC65	1SNA232207R0000	5	3.50
7 (x100)	White	RC65	1SNA232208R1100	5	3.50
8 (x100)	White	RC65	1SNA232209R1200	5	3.50
10 (x100)	White	RC65	1SNA232211R2300	5	3.50
11 (x100)	White	RC65	1SNA232212R2400	5	3.50
12 (x100)	White	RC65	1SNA232213R2500	5	3.50
13 (x100)	White	RC65	1SNA232214R2600	5	3.50
14 (x100)	White	RC65	1SNA232215R2700	5	3.50
15 (x100)	White	RC65	1SNA232216R2000	5	3.50
16 (x100)	White	RC65	1SNA232217R2100	5	3.50
17 (x100)	White	RC65	1SNA232218R0200	5	3.50
18 (x100)	White	RC65	1SNA232219R0300	5	3.50
19 (x100)	White	RC65	1SNA232220R0000	5	3.50
20 (x100)	White	RC65	1SNA232221R2500	5	3.50

Continue on next page →

RC65 terminal block markers

Pre-printed markers for SNA and Solution series

6 mm 0.236 in spacing - horizontal mounting

Ordering details

Description	Color	Type	Part Number	Pkg card	Weight (1 card) g
-------------	-------	------	-------------	----------	-------------------

← Continuation of previous page

Card with 100 markers, alternate odd/even numbers for double deck terminal blocks

1->20 alternate odd/even	White	<input type="checkbox"/>	RC65	1SNA232133R1500	5	3.50
21->40 alternate odd/even	White	<input type="checkbox"/>	RC65	1SNA232134R1600	5	3.50
41->60 alternate odd/even	White	<input type="checkbox"/>	RC65	1SNA232135R1700	5	3.50
61->80 alternate odd/even	White	<input type="checkbox"/>	RC65	1SNA232136R1000	5	3.50
81->100 alternate odd/even	White	<input type="checkbox"/>	RC65	1SNA232137R1100	5	3.50

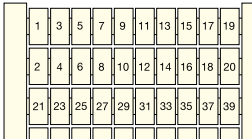

Card with 100 markers, repeated identical letters

A (x100)	White	<input type="checkbox"/>	RC65	1SNA232150R0200	5	3.50
B (x100)	White	<input type="checkbox"/>	RC65	1SNA232151R2700	5	3.50
C (x100)	White	<input type="checkbox"/>	RC65	1SNA232152R2000	5	3.50
D (x100)	White	<input type="checkbox"/>	RC65	1SNA232153R2100	5	3.50
E (x100)	White	<input type="checkbox"/>	RC65	1SNA232154R2200	5	3.50
F (x100)	White	<input type="checkbox"/>	RC65	1SNA232155R2300	5	3.50
G (x100)	White	<input type="checkbox"/>	RC65	1SNA232156R2400	5	3.50
H (x100)	White	<input type="checkbox"/>	RC65	1SNA232157R2500	5	3.50
I (x100)	White	<input type="checkbox"/>	RC65	1SNA232158R0600	5	3.50
J (x100)	White	<input type="checkbox"/>	RC65	1SNA232159R0700	5	3.50
K (x100)	White	<input type="checkbox"/>	RC65	1SNA232160R0400	5	3.50
L (x100)	White	<input type="checkbox"/>	RC65	1SNA232161R2100	5	3.50
M (x100)	White	<input type="checkbox"/>	RC65	1SNA232162R2200	5	3.50
N (x100)	White	<input type="checkbox"/>	RC65	1SNA232163R2300	5	3.50
O (x100)	White	<input type="checkbox"/>	RC65	1SNA232164R2400	5	3.50
P (x100)	White	<input type="checkbox"/>	RC65	1SNA232165R2500	5	3.50
Q (x100)	White	<input type="checkbox"/>	RC65	1SNA232166R2600	5	3.50
R (x100)	White	<input type="checkbox"/>	RC65	1SNA232167R2700	5	3.50
S (x100)	White	<input type="checkbox"/>	RC65	1SNA232168R0000	5	3.50
T (x100)	White	<input type="checkbox"/>	RC65	1SNA232169R0100	5	3.50
U (x100)	White	<input type="checkbox"/>	RC65	1SNA232170R0600	5	3.50
V (x100)	White	<input type="checkbox"/>	RC65	1SNA232171R2300	5	3.50
W (x100)	White	<input type="checkbox"/>	RC65	1SNA232172R2400	5	3.50
X (x100)	White	<input type="checkbox"/>	RC65	1SNA232173R2500	5	3.50
Y (x100)	White	<input type="checkbox"/>	RC65	1SNA232174R2600	5	3.50
Z (x100)	White	<input type="checkbox"/>	RC65	1SNA232175R2700	5	3.50

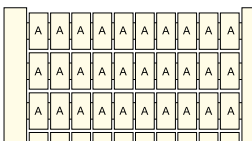

Card with 100 markers, repeated identical symbols

+ (x100)	White	<input type="checkbox"/>	RC65	1SNA232111R1700	5	3.50
- (x100)	White	<input type="checkbox"/>	RC65	1SNA232112R1000	5	3.50
= (x100)	White	<input type="checkbox"/>	RC65	1SNA232113R1100	5	3.50
~ (x100)	White	<input type="checkbox"/>	RC65	1SNA232114R1200	5	3.50
⊥ (x100)	White	<input type="checkbox"/>	RC65	1SNA232115R1300	5	3.50

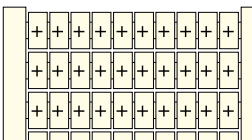

Card with 100 markers, 5 different symbols repeated 20 times

L1-L2-L3-N-PE (x20)	White	<input type="checkbox"/>	RC65	1SNA232131R1300	5	3.50
---------------------	-------	--------------------------	------	-----------------	---	------



Card with 100 markers, repeated identical symbols

L1 (x100)	White	<input type="checkbox"/>	RC65	1SNA232116R1400	5	3.50
L2 (x100)	White	<input type="checkbox"/>	RC65	1SNA232117R1500	5	3.50
L3 (x100)	White	<input type="checkbox"/>	RC65	1SNA232118R2600	5	3.50
PE (x100)	White	<input type="checkbox"/>	RC65	1SNA232119R2700	5	3.50



Card with 100 markers, 9 different symbols repeated 10 times

U1-U2-U3-V1-V2-V3-W1-W2-W3 (x10) + U1 (x10)	White	<input type="checkbox"/>	RC65	1SNA232132R1400	5	3.50
---	-------	--------------------------	------	-----------------	---	------



RC65 terminal block markers

Pre-printed markers for SNA and Solution series

6 mm 0.236 in spacing - vertical mounting

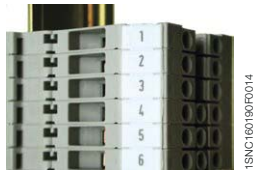

Vertical terminal block assembly

Description

- Save printing time with our large pre-printed card offer with pre-printed numbers, letters or symbols,
- To be used to mark screw clamp and spring clamp (side mounting) terminal blocks, and all Miniblocks from the SNA and Solution series.

Main technical data

Material	Flammability
Polyamide	V2

Ordering details

Description	Color	Type	Part Number	Pkg card	Weight (1 card) g
-------------	-------	------	-------------	----------	-------------------

Card with 100 markers, ascending order repeated 10 times

0->9 (x10)	White	<input type="checkbox"/>	RC65	1SNA232040R0700	5	3.50
1->10 (x10)	White	<input type="checkbox"/>	RC65	1SNA232041R2400	5	3.50
11->20 (x10)	White	<input type="checkbox"/>	RC65	1SNA232042R2500	5	3.50
21->30 (x10)	White	<input type="checkbox"/>	RC65	1SNA232043R2600	5	3.50
31->40 (x10)	White	<input type="checkbox"/>	RC65	1SNA232044R2700	5	3.50
41->50 (x10)	White	<input type="checkbox"/>	RC65	1SNA232045R2000	5	3.50
51->60 (x10)	White	<input type="checkbox"/>	RC65	1SNA232046R2100	5	3.50
61->70 (x10)	White	<input type="checkbox"/>	RC65	1SNA232047R2200	5	3.50
71->80 (x10)	White	<input type="checkbox"/>	RC65	1SNA232048R0300	5	3.50
81->90 (x10)	White	<input type="checkbox"/>	RC65	1SNA232049R0400	5	3.50
91->100 (x10)	White	<input type="checkbox"/>	RC65	1SNA232050R0100	5	3.50
101->110 (x10)	White	<input type="checkbox"/>	RC65	1SNA232051R2600	5	3.50
111->120 (x10)	White	<input type="checkbox"/>	RC65	1SNA232052R2700	5	3.50
121->130 (x10)	White	<input type="checkbox"/>	RC65	1SNA232053R2000	5	3.50
131->140 (x10)	White	<input type="checkbox"/>	RC65	1SNA232054R2100	5	3.50
141->150 (x10)	White	<input type="checkbox"/>	RC65	1SNA232055R2200	5	3.50
151->160 (x10)	White	<input type="checkbox"/>	RC65	1SNA232056R2300	5	3.50
161->170 (x10)	White	<input type="checkbox"/>	RC65	1SNA232057R2400	5	3.50
171->180 (x10)	White	<input type="checkbox"/>	RC65	1SNA232058R0500	5	3.50
181->190 (x10)	White	<input type="checkbox"/>	RC65	1SNA232059R0600	5	3.50
191->200 (x10)	White	<input type="checkbox"/>	RC65	1SNA232072R2300	5	3.50

Card with 100 markers, ascending order

1->100	White	<input type="checkbox"/>	RC65	1SNA232060R0300	5	3.50
101->200	White	<input type="checkbox"/>	RC65	1SNA232061R2000	5	3.50
201->300	White	<input type="checkbox"/>	RC65	1SNA232062R2100	5	3.50
301->400	White	<input type="checkbox"/>	RC65	1SNA232063R2200	5	3.50
401->500	White	<input type="checkbox"/>	RC65	1SNA232064R2300	5	3.50
501->600	White	<input type="checkbox"/>	RC65	1SNA232065R2400	5	3.50
601->700	White	<input type="checkbox"/>	RC65	1SNA232066R2500	5	3.50
701->800	White	<input type="checkbox"/>	RC65	1SNA232067R2600	5	3.50
801->900	White	<input type="checkbox"/>	RC65	1SNA232068R0700	5	3.50
901->1000	White	<input type="checkbox"/>	RC65	1SNA232069R0000	5	3.50

Card with 100 markers, repeated identical numbers

0 (x100)	White	<input type="checkbox"/>	RC65	1SNA232240R1400	5	3.50
1 (x100)	White	<input type="checkbox"/>	RC65	1SNA232241R0100	5	3.50
2 (x100)	White	<input type="checkbox"/>	RC65	1SNA232242R0200	5	3.50
3 (x100)	White	<input type="checkbox"/>	RC65	1SNA232243R0300	5	3.50
4 (x100)	White	<input type="checkbox"/>	RC65	1SNA232244R0400	5	3.50
5 (x100)	White	<input type="checkbox"/>	RC65	1SNA232245R0500	5	3.50
6 (x100) / 9 (x100)	White	<input type="checkbox"/>	RC65	1SNA232246R0600	5	3.50
7 (x100)	White	<input type="checkbox"/>	RC65	1SNA232247R0700	5	3.50
8 (x100)	White	<input type="checkbox"/>	RC65	1SNA232248R1000	5	3.50
10 (x100)	White	<input type="checkbox"/>	RC65	1SNA232250R1600	5	3.50
11 (x100)	White	<input type="checkbox"/>	RC65	1SNA232251R0300	5	3.50
12 (x100)	White	<input type="checkbox"/>	RC65	1SNA232252R0400	5	3.50
13 (x100)	White	<input type="checkbox"/>	RC65	1SNA232253R0500	5	3.50
14 (x100)	White	<input type="checkbox"/>	RC65	1SNA232254R0600	5	3.50
15 (x100)	White	<input type="checkbox"/>	RC65	1SNA232255R0700	5	3.50
16 (x100)	White	<input type="checkbox"/>	RC65	1SNA232256R0000	5	3.50
17 (x100)	White	<input type="checkbox"/>	RC65	1SNA232257R0100	5	3.50
18 (x100)	White	<input type="checkbox"/>	RC65	1SNA232258R1200	5	3.50
19 (x100)	White	<input type="checkbox"/>	RC65	1SNA232259R1300	5	3.50
20 (x100)	White	<input type="checkbox"/>	RC65	1SNA232260R1000	5	3.50

Continue on next page →



RC65 terminal block markers

Pre-printed markers for SNA and Solution series

6 mm 0.236 in spacing - vertical mounting

Ordering details

Description	Color	Type	Part Number	Pkg card	Weight (1 card) g
-------------	-------	------	-------------	----------	-------------------

← Continuation of previous page

Card with 100 markers, repeated identical letters

A (x100)	White	<input type="checkbox"/>	RC65	1SNA232180R2100	5	3.50
B (x100)	White	<input type="checkbox"/>	RC65	1SNA232181R1600	5	3.50
C (x100)	White	<input type="checkbox"/>	RC65	1SNA232182R1700	5	3.50
D (x100)	White	<input type="checkbox"/>	RC65	1SNA232183R1000	5	3.50
E (x100)	White	<input type="checkbox"/>	RC65	1SNA232184R1100	5	3.50
F (x100)	White	<input type="checkbox"/>	RC65	1SNA232185R1200	5	3.50
G (x100)	White	<input type="checkbox"/>	RC65	1SNA232186R1300	5	3.50
H (x100)	White	<input type="checkbox"/>	RC65	1SNA232187R1400	5	3.50
I (x100)	White	<input type="checkbox"/>	RC65	1SNA232188R2500	5	3.50
J (x100)	White	<input type="checkbox"/>	RC65	1SNA232189R2600	5	3.50
K (x100)	White	<input type="checkbox"/>	RC65	1SNA232190R2300	5	3.50
L (x100)	White	<input type="checkbox"/>	RC65	1SNA232191R1000	5	3.50
M (x100)	White	<input type="checkbox"/>	RC65	1SNA232192R1100	5	3.50
N (x100)	White	<input type="checkbox"/>	RC65	1SNA232193R1200	5	3.50
O (x100)	White	<input type="checkbox"/>	RC65	1SNA232194R1300	5	3.50
P (x100)	White	<input type="checkbox"/>	RC65	1SNA232195R1400	5	3.50
Q (x100)	White	<input type="checkbox"/>	RC65	1SNA232196R1500	5	3.50
R (x100)	White	<input type="checkbox"/>	RC65	1SNA232197R1600	5	3.50
S (x100)	White	<input type="checkbox"/>	RC65	1SNA232198R2700	5	3.50
T (x100)	White	<input type="checkbox"/>	RC65	1SNA232199R2000	5	3.50
U (x100)	White	<input type="checkbox"/>	RC65	1SNA232200R1500	5	3.50
V (x100)	White	<input type="checkbox"/>	RC65	1SNA232235R2300	5	3.50
W (x100)	White	<input type="checkbox"/>	RC65	1SNA232236R2400	5	3.50
X (x100)	White	<input type="checkbox"/>	RC65	1SNA232237R2500	5	3.50
Y (x100)	White	<input type="checkbox"/>	RC65	1SNA232238R0600	5	3.50
Z (x100)	White	<input type="checkbox"/>	RC65	1SNA232239R0700	5	3.50

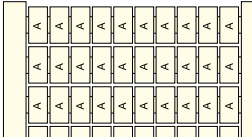

RCAL85 terminal block markers

Pre-printed markers for SNA and Solution series

8 mm 0.315 in spacing - horizontal mounting

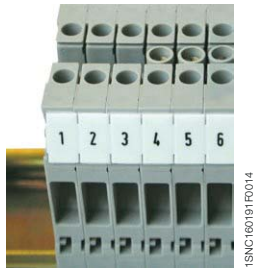

Horizontal terminal block assembly

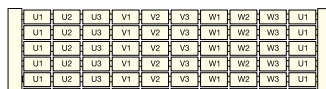
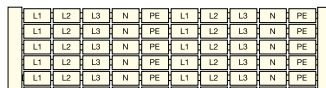
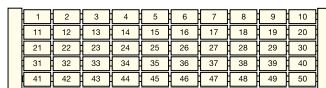

Description

- Save printing time with our large pre-printed card offer with pre-printed numbers, letters or symbols,
- To be used to mark spring clamp terminal blocks and ADO System® Miniblocks from the SNA and Solution series.

Main technical data

Material	Flammability
Polyamide	V2

Ordering details

Description	Color	Type	Part Number	Pkg card	Weight (1 card) g
Card with 100 markers, ascending order repeated 10 times					
0->9 (x10)	White	<input type="checkbox"/> RCAL85	1SNA237001R2200	5	2.90
1->10 (x10)	White	<input type="checkbox"/> RCAL85	1SNA237002R2300	5	2.90
11->20 (x10)	White	<input type="checkbox"/> RCAL85	1SNA237003R2400	5	2.90
21->30 (x10)	White	<input type="checkbox"/> RCAL85	1SNA237004R2500	5	2.90
31->40 (x10)	White	<input type="checkbox"/> RCAL85	1SNA237005R2600	5	2.90
41->50 (x10)	White	<input type="checkbox"/> RCAL85	1SNA237006R2700	5	2.90
51->60 (x10)	White	<input type="checkbox"/> RCAL85	1SNA237007R2000	5	2.90
61->70 (x10)	White	<input type="checkbox"/> RCAL85	1SNA237008R0100	5	2.90
71->80 (x10)	White	<input type="checkbox"/> RCAL85	1SNA237009R0200	5	2.90
81->90 (x10)	White	<input type="checkbox"/> RCAL85	1SNA237010R2600	5	2.90
91->100 (x10)	White	<input type="checkbox"/> RCAL85	1SNA237011R1300	5	2.90
101->110 (x10)	White	<input type="checkbox"/> RCAL85	1SNA237012R1400	5	2.90
111->120 (x10)	White	<input type="checkbox"/> RCAL85	1SNA237013R1500	5	2.90
121->130 (x10)	White	<input type="checkbox"/> RCAL85	1SNA237014R1600	5	2.90
131->140 (x10)	White	<input type="checkbox"/> RCAL85	1SNA237015R1700	5	2.90
141->150 (x10)	White	<input type="checkbox"/> RCAL85	1SNA237016R1000	5	2.90
151->160 (x10)	White	<input type="checkbox"/> RCAL85	1SNA237017R1100	5	2.90
161->170 (x10)	White	<input type="checkbox"/> RCAL85	1SNA237018R2200	5	2.90
171->180 (x10)	White	<input type="checkbox"/> RCAL85	1SNA237019R2300	5	2.90
181->190 (x10)	White	<input type="checkbox"/> RCAL85	1SNA237020R2000	5	2.90
191->200 (x10)	White	<input type="checkbox"/> RCAL85	1SNA237021R1500	5	2.90

Card with 100 markers, ascending order

1->100	White	<input type="checkbox"/> RCAL85	1SNA237030R2200	5	2.90
101->200	White	<input type="checkbox"/> RCAL85	1SNA237031R1700	5	2.90
201->300	White	<input type="checkbox"/> RCAL85	1SNA237032R1000	5	2.90
301->400	White	<input type="checkbox"/> RCAL85	1SNA237033R1100	5	2.90
401->500	White	<input type="checkbox"/> RCAL85	1SNA237034R1200	5	2.90
501->600	White	<input type="checkbox"/> RCAL85	1SNA237035R1300	5	2.90
601->700	White	<input type="checkbox"/> RCAL85	1SNA237036R1400	5	2.90
701->800	White	<input type="checkbox"/> RCAL85	1SNA237074R2200	5	2.90
801->900	White	<input type="checkbox"/> RCAL85	1SNA237075R2300	5	2.90
901->1000	White	<input type="checkbox"/> RCAL85	1SNA237076R2400	5	2.90

Card with 100 markers, 5 different symbols repeated 20 times

L1-L2-L3-N-PE (x20)	White	<input type="checkbox"/> RCAL85	1SNA237131R1000	5	2.90
---------------------	-------	---------------------------------	-----------------	---	------

Card with 100 markers, 9 different symbols repeated 10 times

U1-U2-U3-V1-V2-V3-W1-W2-W3 (x10) + U1 (x10)	White	<input type="checkbox"/> RCAL85	1SNA237132R1100	5	2.90
---	-------	---------------------------------	-----------------	---	------

5

1SNC160152S0201

RCAL85 terminal block markers

Pre-printed markers for SNA and Solution series

8 mm 0.315 in spacing - vertical mounting

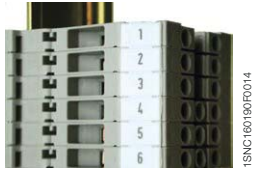

Vertical terminal block assembly

Description

- Save printing time with our large pre-printed card offer with pre-printed numbers, letters or symbols,
- To be used to mark spring clamp terminal blocks and ADO System® Miniblocks from the SNA and Solution series.

Main technical data

Material	Flammability
Polyamide	V2

Ordering details

Description	Color	Type	Part Number	Pkg card	Weight (1 card) g
-------------	-------	------	-------------	----------	-------------------

Card with 100 markers, ascending order repeated 10 times

0->9 (x10)	White	<input type="checkbox"/>	RCAL85	1SNA237040R0400	5	2.90
1->10 (x10)	White	<input type="checkbox"/>	RCAL85	1SNA237041R2100	5	2.90
11->20 (x10)	White	<input type="checkbox"/>	RCAL85	1SNA237042R2200	5	2.90
21->30 (x10)	White	<input type="checkbox"/>	RCAL85	1SNA237043R2300	5	2.90
31->40 (x10)	White	<input type="checkbox"/>	RCAL85	1SNA237044R2400	5	2.90
41->50 (x10)	White	<input type="checkbox"/>	RCAL85	1SNA237045R2500	5	2.90
51->60 (x10)	White	<input type="checkbox"/>	RCAL85	1SNA237046R2600	5	2.90
61->70 (x10)	White	<input type="checkbox"/>	RCAL85	1SNA237047R2700	5	2.90
71->80 (x10)	White	<input type="checkbox"/>	RCAL85	1SNA237048R0000	5	2.90
81->90 (x10)	White	<input type="checkbox"/>	RCAL85	1SNA237049R0100	5	2.90
91->100 (x10)	White	<input type="checkbox"/>	RCAL85	1SNA237050R0600	5	2.90
101->110 (x10)	White	<input type="checkbox"/>	RCAL85	1SNA237051R2300	5	2.90
111->120 (x10)	White	<input type="checkbox"/>	RCAL85	1SNA237080R2500	5	2.90
121->130 (x10)	White	<input type="checkbox"/>	RCAL85	1SNA237081R1200	5	2.90
131->140 (x10)	White	<input type="checkbox"/>	RCAL85	1SNA237082R1300	5	2.90
141->150 (x10)	White	<input type="checkbox"/>	RCAL85	1SNA237083R1400	5	2.90
151->160 (x10)	White	<input type="checkbox"/>	RCAL85	1SNA237084R1500	5	2.90
161->170 (x10)	White	<input type="checkbox"/>	RCAL85	1SNA237085R1600	5	2.90
171->180 (x10)	White	<input type="checkbox"/>	RCAL85	1SNA237086R1700	5	2.90
181->190 (x10)	White	<input type="checkbox"/>	RCAL85	1SNA237087R1000	5	2.90
191->200 (x10)	White	<input type="checkbox"/>	RCAL85	1SNA237088R2100	5	2.90

Card with 100 markers, ascending order

1->100	White	<input type="checkbox"/>	RCAL85	1SNA237060R0000	5	2.90
101->200	White	<input type="checkbox"/>	RCAL85	1SNA237061R2500	5	2.90
201->300	White	<input type="checkbox"/>	RCAL85	1SNA237062R2600	5	2.90
301->400	White	<input type="checkbox"/>	RCAL85	1SNA237063R2700	5	2.90
401->500	White	<input type="checkbox"/>	RCAL85	1SNA237064R2000	5	2.90
501->600	White	<input type="checkbox"/>	RCAL85	1SNA237065R2100	5	2.90
601->700	White	<input type="checkbox"/>	RCAL85	1SNA237066R2200	5	2.90
701->800	White	<input type="checkbox"/>	RCAL85	1SNA237067R2300	5	2.90
801->900	White	<input type="checkbox"/>	RCAL85	1SNA237068R0400	5	2.90

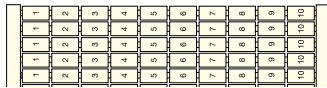

RCT terminal block markers

Pre-printed markers for SNA and Solution series

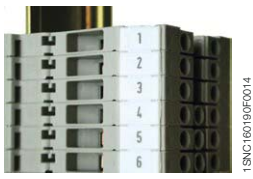

Vertical terminal block assembly

Description

- Save printing time with our large pre-printed card offer with pre-printed numbers, letters or symbols,
- Card with 100 markers, ascending order.

Main technical data

Material	Flammability
Polyamide	V2

Ordering details

Description	Color	Type	Part Number	Pkg card	Weight (1 card) g
-------------	-------	------	-------------	----------	-------------------

6 mm 0.236 in spacing

RCT610

To be used to top mark MA2,5/5-CPE..., screw clamp, ADO System® and spring loaded screw clamp (top marking) terminal blocks from the SNA and Solution series.

1 -> 100	White <input type="checkbox"/>	RCT610	1SNA236001R2100	5	6.00
----------	--------------------------------	--------	-----------------	---	------

8 mm 0.315 in spacing

RCT810

To be used to mark 9.5 mm 0.374 in or 12.5 mm 0.492 in spacing screw clamp (top marking), ADO System®, spring loaded screw clamp and ring lug terminal blocks from the SNA and Solution series.

1 -> 100	White <input type="checkbox"/>	RCT810	1SNA236501R2300	5	8.00
----------	--------------------------------	--------	-----------------	---	------

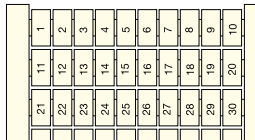

RTM terminal block markers

Pre-printed markers for SNA and Solution series

6 mm 0.236 in to 12 mm 0.472 in spacing - top marking

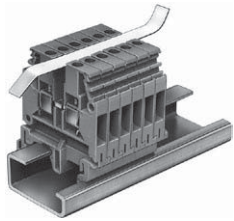

RTM7

1SNC160193FD014

Description

- Save printing time with our large pre-printed card offer with pre-printed numbers, letters or symbols,
- To be used to mark screw clamp and ADO System® terminal blocks from the SNA and Solution series,
- Spacing corresponds to the pitch between numbers.

Main technical data

Material	Flammability
PVC	V0

Ordering details

Length mm	Color	Type	Part Number	Pkg card	Weight (1 card) g
--------------	-------	------	-------------	-------------	----------------------

6 mm 0.236 in spacing

1 marking strip with black print from 1 to 50 on one side and 51 to 100 on the other side

300	White <input type="checkbox"/>	RTM7	1SNA103115R1300	1	1.00
-----	--------------------------------	------	-----------------	---	------

8 mm 0.315 in spacing

1 marking strip with black print from 1 to 50 on one side and 51 to 100 on the other side

400	White <input type="checkbox"/>	RTM7	1SNA103116R1400	1	1.00
-----	--------------------------------	------	-----------------	---	------

10 mm 0.394 in spacing

1 marking strip with black print from 1 to 50 on one side and 51 to 100 on the other side

500	White <input type="checkbox"/>	RTM7	1SNA103922R1400	1	1.00
-----	--------------------------------	------	-----------------	---	------

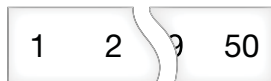
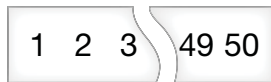

1SNC160156S0201

REH3 terminal block markers

Pre-printed markers for Solution series



Horizontal terminal block assembly



Description

- Save printing time with our large pre-printed card offer with pre-printed numbers, letters or symbols,
- To be used to mark 13 mm *0.512 in* or 16 mm *0.630 in* spacing ring lug terminal blocks from the Solution series,
- Red print on white background (black print on white background on request).

Main technical data

Material	Flammability
Cellulose acetate	V2

Ordering details

Description	Color	Type	Part Number	Pkg card	Weight (1 card) g
Card with 680 precut labels with numbers - Red print on white background					
6 series from 1 to 102 + 1 series from 103 to 170	Red	REH3	1SNA163167R2200	1	20.00
22 series from 1 to 30 + 1 series from 1 to 20	Red	REH3	1SNA164695R2500	1	20.00

EPU terminal block markers

Pre-printed cover marker for SNA series

5 mm 0.197 in to 12 mm 0.472 in spacing - top marking

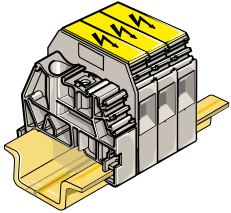

EPU5

Description

- Protective label used to indicate live circuits,
- Prohibits access to connection screws,
- To be snapped directly onto the terminal block,
- To be used to cover one single screw clamp terminal block from the SNA and Solution series.

Main technical data

Material	Flammability
Polyamide	V2

Ordering details

Description	Color	Type	Part Number	Pkg card	Weight (1 card) g
-------------	-------	------	-------------	-------------	----------------------

5 mm 0.197 in spacing

EPU5

For MA2,5/5 SNA terminal blocks

Yellow label with black arrow	Yellow 	EPU5	1SNA107033R1000	1	2.00
-------------------------------	--	------	-----------------	---	------

6 mm 0.237 in to 10 mm 0.394 in spacing

EPU6

For M4/6, M6/8, M10/10 and M16/12 SNA terminal blocks (use two labels for M16/12)

Yellow label with black arrow	Yellow 	EPU6	1SNA107038R2500	1	2.00
-------------------------------	---	------	-----------------	---	------

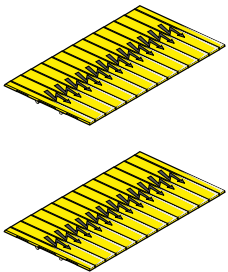

EP terminal block markers

Pre-printed cover marker for SNA and Solution series

6 mm 0.236 in to 22 mm 0.866 in spacing - top marking

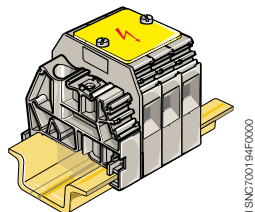

EP

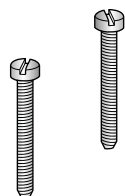
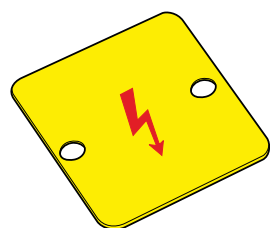

Description

- Yellow label with red arrow, used to indicate live circuits,
- Prohibits access to connection screws and protects connections from dust and from touch,
- To be mounted using 2 nylon VSP screws (ordered separately),
- Can cover 3 or 4 terminal blocks.

Main technical data

Material	Flammability
PVC	V0

Ordering details

Description	Color	Type	Part Number	Pkg card	Weight (1 card) g
EP6 For 4x M4/6, or 3x M6/8 or M6/8.RS terminal blocks	Yellow	EP6	1SNA163427R1700	10	0.41
EP8 For 4x M6/8 or M6/8.RS, or 3x M10/10 or M10/10.RS terminal blocks	Yellow	EP8	1SNA163428R2000	10	0.59
EP10 For 4x M10/10 or M10/10.RS, or 3x M16/12 terminal blocks	Yellow	EP10	1SNA163429R2100	10	0.74
EP12 For 4x M16/12 or 3x M35/16 terminal blocks	Yellow	EP12	1SNA163430R2600	10	0.85
EP16 For 4x M35/16 terminal blocks	Yellow	EP16	1SNA163431R1300	10	1.1
EP223 For 3x D70/22 terminal blocks	Yellow	EP223	1SNA173327R2400	10	
EP224 For 4x D70/22 terminal blocks	Yellow	EP224	1SNA173328R0500	10	10.00

Compatible screws

Nylon screw	VSP6	1SNA163433R1500	20	0.21
Nylon screw	VSP12	1SNA163432R1400	20	0.1
Nylon screw	VSP16	1SNA173147R2000	20	0.3
Nylon screw	VSP68	1SNA206103R0700	20	0.6
Nylon screw	VSP22	1SNA400252R1200	20	0.25

Selection guide for cover and fixing screw depending on terminal block type

Terminal block	3 terminal blocks aligned		4 terminal blocks aligned		Screws for protection label	
Type	Cover type	Cover part number	Cover type	Cover part number	Type	Part Number
M4/6	-	-	EP6	1SNA163427R1700	VSP6	1SNA163433R1500
M6/8	EP6	1SNA163427R1700	EP8	1SNA163428R2000		
M10/10	EP8	1SNA163428R2000	EP10	1SNA163429R2100		
M16/12	EP10	1SNA163429R2100	EP12	1SNA163430R2600	VSP12	1SNA163432R1400
M35/16	EP12	1SNA163430R2600	EP16	1SNA163431R1300	VSP16	1SNA173147R2000
D70/22	EP223	1SNA173327R2400	EP224	1SNA173328R0500	VSP22	1SNA400252R1200
M6/8.RS	EP6	1SNA163427R1700	EP8	1SNA163428R2000	VSP68	1SNA206103R0700
M10/10.RS	EP8	1SNA163428R2000	EP10	1SNA163429R2100		



MG3 markers selection guide for other manufacturers' terminal blocks

Terminal block

MG-CPM terminal block markers are available in versions to suit the particular terminal block formats of the most widely used products, see selection guide to side.

Depending on type, markers are presented as joined strips at a set or as separate markers for convenient individual insertion on mixed spacing terminal block assemblies.

Order form Customized marking

Markers

Strip markers

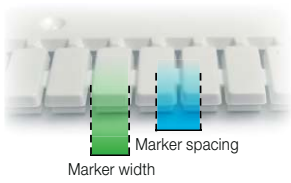

Individual markers

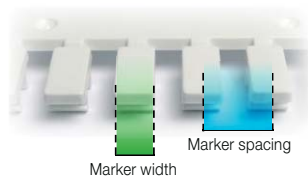

Strip mounting (Marker spacing = Terminal block spacing)

P - Single clips to spacing



Marker width = Terminal block width

M - Modular strip



Marker width < Terminal block width

CP - Single clips compatible to spacing



Marker width < Terminal block width

Individual mounting (Marker spacing ≠ Terminal block spacing)

S - Single clips



Marker width = Terminal block width

C - Single clips compatible



Marker width < Terminal block width

MG3 markers selection guide for other manufacturers' terminal blocks

BECKHOFF

Terminal block	Size mm	Marker
	KL 9010	4.2x9

Cabur

Terminal block	Size mm	Marker					
		5x10	5x10	5x10	6x10	5x12	4.2x9
CBD.2/4		S	P	P			
CBD.4/6		C	C	M	C	M	
CBD.2/4/SH		S	S		P		
CBD.4/6/SH		C	C	M	C	M	
CBD.6/10		C	CP		C		
CBD.10/6		C	C		C		
CBD.16/25		C	C		C		
CBD.35		C	C		C		
CBC.2/4		P	M	S	S		
CBC.4/6		C	C	M	C	M	
CBC 35/50		C	C		C		
DAS.4/6...DAS.4/6/SS		C	C		C		
DSS.4/6		C	C	M	C	M	
CBR.2/4		P	M	S	S		
FVS.4/6		C	C	M	C	M	
FFS.4/6		C	C	M	C	M	
TLS.2/4		C	C		C		
TLE.2/4		C	C		C		
TLD.2/4		C	C		C		
TDE.2/4		C	C		C		
PCE.4/6/...		C	C	M	C	M	
PCE.4/X...		C	C		C		
SFR.4/6...SFR.4/6/C230		C	CP		C		
SFO.4/6...SFO.4/6/C230		C	CP	M	C	M	
FPC.10/16		C	C		C		
FPL.10/16...FPL.10/16/C230		C	C		C		
SFR.4/D1A...SFR.4/D3A		C	CP		C		
MPS.2/4/SW...MPS.2/4/SV		S	S		P		
MPS.4/6...MPS.4/6/VS		C	C		C		
SCB.4/6...SCB.8/10/CD		C	C		C		
AFO.2/1+1...AFO.2/2+2/TP		C	C		C		
PDF.2		C	C		C		
FDP.2		C	C		C		
CVF.4/6...CVF.4/6/TP		C	C		C		
TC/PO		S	S		P		
VPC.2/4		S	S	S	S		
VPD.2/		S	S		S		
GPM.95/BB...GPM.240/300/CC		C	C		C		
GPA.70...GPA.240		C	C		C		
ACB.70/BB...ACB.185/240/CC		C	C		C		
BCA.70/BB...BCA.120/185/CC		C	C		C		

Cabur

Terminal block	Size mm	Marker					
		5x10	5x10	5x10	6x10	5x12	4.2x9
MBL.50/6...MBL.150/12		C	C		C		
TEO.2/4		S	S		P		
TEO.4/6		C	C	M	C		
CBE.2/4		P	M	S	S		
TE.4/6/D...TE.50/D...TE.50/O		C	C		S		
RN.2/4		P	M	S	S		
RP.4/6		C	C		C		
RFL.2		C	C		C		
TR.2/4		P	M	S	S		
TR.4/6		P	M	S	S		
MAC.6/10...MAC.6/10/N		C	CP		C		
CAM...CAM/C		C	CP		C		
NCS		C	C		C		
NCV		C	C		C		
CNT.6...CNT.35		C	P		C		
HMM.1/2,5...HMM.1/2,5/2+2						P	
HMM.2/4...HMM.6/10					C		
HTE.2/4...HTE.6/10					C		
HMD.2N...HMD.2/4					C	P	
HMS.2/4					C		
HMF.4/6...HMF.4/6/L115					C		
EDM.2/4		S	S		P		
EDM.4/6...EDM.70/50/BC		C	C	M			
SV.2...SV.2/VS		S	S		P		
SV.4/6...SV.10/16		C	C		C		
CPS.4/6		C	C		C		
SCX.10/16...SCX.10/16-PI		C	C		C		
SFC.10/16		C	C		C		
SFL.10/16		C	C		C		
FLD.10/16/F5...FLD.10/16/D		C	C		C		
VLM.10/16...VLM.10/16/O		C	C		C		
VL.16...VL.16/O-M		C	C		C		
TC/DIN		S	S		P		
VNF.6/10...VNF.6/10/STP		C	C		C		
CDA.70/BC...CDA.185/BB		C	C		C		
BTU		C	P		C		
BT/3		C	P		C		
BT/2		C	P		C		
BT/DIN/PO		C	P		C		

Connectwell

Terminal block	Size mm	Marker								
		5x10	5x15	5x7	5x10	5x10	5x10	5x10	5x12	4.2x9
CDB4/2(1)					S	S	P	P	M	
CMC2-2					S	S	P	P	M	
CGT6N					S	S	S	S		
CSCG10T					S	S	S	S		

MG3 markers selection guide for other manufacturers' terminal blocks

Connectwell

Terminal block	Size mm									
	5x10	5x15	5x7	5x10	5x10	5x10	5x10	5x10	5x12	4.2x9
Marker	MG-CPM-01 41090N	MG-CPM-01 41091N	MG-CPM-01 41094	MG-CPM-03 41291	MG-CPM-03 41293	MG-CPM-04 41390N	MG-CPM-04 41340N	MG-CPM-04 41395	MG-CPM-10 41692	MG-CPM-12 46390
CGT16N				S	S	S				
AS2.5/4				S	S	P	P	M		
CTU4U				S	S	P	P	M		
CTS6UCR				S	S	S				
CTS4UN				S	S	P	P	M		
CT25UCR				S	S	S				
CMDB4/2				S	S	S				
CSDL6U				S	S	S				
CSC2.5T1-2				S	S	P	P	M		
AS6				S	S	S				
CT25U				S	S	S				
CGT4UN				S	S	P	P	M		
CGT10N				S	S	S				
DDFL4UELR24V				S	S	S				
DDFL4UEL				S	S	S				
CSC2.5T2-2				S	S	P	P	M		
CTS10U				S	S	S				
AS4/3				S	S	S				
CTS10USC				S	S	S				
AS2.5/3				S	S	P	P	M		
CENC16				S	S	S				
DDFL4U				S	S	S				
CTS2.5UNCR				S	S	P	P	M		
CDTTU				S	S	S				
CSC4T1-2				S	S	P	P	M		
CKT4U				S	S	S				
CSC4T2-2				S	S	S				
CSCG4T				S	S	S				
CTS6U				S	S	S				
CSC4T				S	S	S				
CSCG2.5T				S	S	P	P	M		
CSFL6U				S	S	S				
CENC35				S	S	S				
CGT10U				S	S	S				
CSDL4U				S	S	S				
CSC6T				S	S	S				
CGT4U				S	S	S				
AS4/4				S	S	S				
AS4				S	S	S				
CTS4UNCR				S	S	S				
CTS6USC				S	S	S				
STH4				S	S	S				
CTS16U				S	S	S				
CSCG16T				S	S	S				
CSC6T1-2				S	S	S				
CSC2.5T				S	S	P	P	M		
ODL4U				S	S	S				
CMC1-2				S	S	S				
CDB6/2				S	S	S				
ODL4UA				S	S	S				
AS2.5				S	S	P	P	M		
ADL2.5				S	S	P	P	M		
CDB25/2				S	S	S				
CTS25U				S	S	S				
CDTTUSH				S	S	S				
CTS35UN				S	S	S				
CT35UCR				S	S	S				
CTS10UCR				S	S	S				
CMDB10/2				S	S	S				

Connectwell

Terminal block	Size mm									
	5x10	5x15	5x7	5x10	5x10	5x10	5x10	5x10	5x12	4.2x9
Marker	MG-CPM-01 41090N	MG-CPM-01 41091N	MG-CPM-01 41094	MG-CPM-03 41291	MG-CPM-03 41293	MG-CPM-04 41390N	MG-CPM-04 41340N	MG-CPM-04 41395	MG-CPM-10 41692	MG-CPM-12 46390
CTS25UN				S	S	S				
CMDB6/2				S	S	S				
CGT35U				S	S	S				
CSC16T				S	S	S				
CTS95U	S	S	S						S	M
CSC10T				S	S	S				
CTS35U				S	S	S				
CTS16UCR				S	S	S				
CTS50U	S	S	S						S	M
CSFL4U				S	S	S				
STH4DT				S	S	S				
CDB10/2				S	S	S				
ASF4				S	S	S				
DDFL4UE24V				S	S	S				
CSFL4UL24V				S	S	S				
DDDL4U				S	S	S				
DDFL4ULR				S	S	S				
CTS4UNCR				S	S	S				
CTS2.5UN				S	S	P	P	M		
CMDB6/2				S	S	S				
CTS2.5M					S					M
CTS4SC					S					M
CTS6					S					M
CTS6SC					S					M
CTSSRN5					S					M
CTS10SC										M
CTS16					S					M
CTS10					S					M

Conta Clip

Terminal block	Size mm			
	5x10	5x15	5x10	5x7
Marker	MG-CPM-01 41090N	MG-CPM-01 41091N	MG-CPM-02 41190N	MG-CPM-01 41094
PK-TS 15/35	C	C	C	C
ZRKG	C	C	C	C
ZSLG	C	C	C	C
ZSLN	C	C	C	C
ZSRK	C	C	C	C
ZVMAK	C	C	C	C

Legrand

Series Viking 3	MG-CPM-09 41890 5x10 mm white PVC legend
-----------------	--

MG3 markers selection guide for other manufacturers' terminal blocks

Phoenix Contact

Terminal block	Size mm				
	5x10	5x10	5x10	6x10	5x10
Marker	MG-CPM-03 41291	MG-CPM-04 41390N	MG-CPM-04 41395	MG-CPM-04 41391	MG-CPM-07 41691
	STF-04 42804 bracket				
UK 3 - EX	S	P	M		M
UK 3 - RETURN	S	P	M		M
UK 3 - RETURN - PE	S	P	M		M
UK 3 - TWIN	S	P	M		M
UK 3 - TWIN - PE	S	P	M		M
UK 3 N	S	P	M		M
UK 4	C	C	P		M
UK 4 - TG	C	C	P		M
UK 4 - TG - LOER - P/P	C	C	P		M
UK 4 FS / FS	C	C	P		M
UK 4 FSR	C	C	P		M
UK 4 LOER	C	C	P		M
UK 4 TP	C	C	P		M
UK 4 TP / TP	C	C	P		M
UK 5	C	C	C		M
UK 5 - HESI	C	C	C		M
UK 5 - MTK - P/P	C	C	C		M
UK 5 - R - L	C	C	C		M
UK 5 - TWIN	C	C	C		M
UK 5 - TWIN - EX	C	C	C		M
UK 5 / R - DRAHT	C	C	C		M
UK 5 N	C	C	C		M
UK 5 RETURN	C	C	C		M
UK 5 RETURN - PE	C	C	C		M
UK 5 TWIN	C	C	C		M
UK 5 TWIN - PE	C	C	C		M
UK 6	C	C	C		M
UK 6 N	C	C	C		M
UK 6,3 HESI	C	C	C		M
UK 10	C	C	C		M
UK 10 - DREHSI	C	C	C		M
UK 10 - EX	C	C	C		M
UK 10 - N-PE / N	C	C	C		M
UK 10 - PLUS	C	C	C		M
UK 10 - PLUS - PE	C	C	C		M
UK 10 - TWIN	C	C	C		M
UK 10 - TWIN - PE	C	C	C		M
UK 10 N	C	C	C		M
UK 10 RETURN	C	C	C		M
UK 10 RETURN - PE	C	C	C		M
UK 10,3 - HESI	C	C	C		M
UK 16	C	C	C		M
UK 16 - EX	C	C	C		M
UK 16 - PE / N	C	C	C		M
UK 16 N	C	C	C		M
UK 16 N - EX	C	C	C		M
UK 16 N - PE / N	C	C	C		M
UK 35	C	C	C		M
UK 35 - EX	C	C	C		M
UK 35 - PE / N	C	C	C		M
UK SI	C	C	C		M
UKB 4 FS ...	C	C	C		M
UKD 4 PE	C	C	C		M
UKH 25	C	C	C		M
UKH 50	C	C	C		M
UKH 50 - PE / N	C	C	C		M
UKH 95	C	C	C		M
UKH 95 - PE / N	C	C	C		M

Phoenix Contact

Terminal block	Size mm				
	5x10	5x10	5x10	6x10	5x10
Marker	MG-CPM-03 41291	MG-CPM-04 41390N	MG-CPM-04 41395	MG-CPM-04 41391	MG-CPM-07 41691
	STF-04 42804 bracket				
UKH 150	C	C	C		M
UKH 240	C	C	C		M
UKK 3	S	S	C		M
UKK 4 - FS	C	C	P		M
UKK 4 - FS / FS	C	C	P		M
UKK 5	C	C	C		M
UKK 5 - DIO	C	C	C		M
UKK 5 - TG	C	C	C		M
UKK 5 -2 -DIO	C	C	C		M
UKK 5 -LA	C	C	C		M
UKKB 3	S	P	M		C
UKKB 5	C	C	C		M
UKKB 10	C	C	C		M
UKKB 10 / 2.5	C	C	C		M
UKKB 10 / 2.5 - PE	C	C	C		M
UKN 2.5	C	C	C		M
UKN 4	C	C	P		M
UKN 5	C	C	C		M
UKN 10 (N)	C	C	C		M
UKN 16	C	C	C		M
UKN 16N	C	C	C		M
UKN 35	C	C	C		M
UKSN	C	C	C		M
URK - ND	C	C	C		M
URK - ND 2	C	C	C		M
URKN	C	C	C		M
URKN - A	C	C	C		M
URKN / S	C	C	C		M
URTK - BEN	C	C	C		M
URTK / S	C	C	C		M
URTK / S - BEN	C	C	C		M
URTK / SS	C	C	C		M
URTKD / SP	C	C	C		M
USED 16	C	C	C		M
USED 27	C	C	C		M
USEN 14	C	C	C		M
USEN 18	C	C	C		M
USK / SGSK	C	C	C		M
USK 4 FSR...	C	C	P		M
USLKG 2.5	S	S			M
USLKG 2.5 - N	S	S			M
USLKG 3	S	S			M
USLKG 4	C	C	P		M
USLKG 5	C	C	C		M
USLKG 10 (N)	C	C	C		M
USLKG 16	C	C	C		M
USLKG 16 N	C	C	C		M
USLKG 35	C	C	C		M
USLKG 50	C	C	C		M
USLKG 95	C	C	C		M
UT 4	C	C	P		M
UT 4 BU	C	C	P		M
UT 4 YE	C	C	P		M
UT 4-MTD BU	C	C	P		M
UT 4-MTD-PE	C	C	P		M
UTK 35	C	C	C		M
UXKK 4	C	C	C		M
VBSN 4 FS ...	C	C	C		M

MG3 markers selection guide for other manufacturers' terminal blocks

Phoenix Contact

Size mm	5x10	5x10	5x10	6x10	5x10															
Marker	MG-CPM-03 41291	MG-CPM-04 41390N	MG-CPM-04 41395	MG-CPM-04 41391	MG-CPM-07 41691	STF-04 42804 bracket														
Terminal block																				
VBST 4 FS / FS	C	C					M													
VIOK 1.5	C	C					M													
VIOK 1.5-2D	C	C					M													
VIOK 1.5-3D/PE	C	C					M													
VIOK 1.5-D/TG/D/PE	C	C					M	M												
VIOK 1.5-LA	C	C					M													
ZFDK 2.5	C	C					M													
ZFDK -PE	C	C					M													
ZFK 2.5 - PE	C	C					M													
ZFK 2.5 - PE / L / N	C	C					M													
ZFK 2.5 - TWIN	C	C					M													
ZFK 2.5 - TWIN - PE	C	C					M													
ZFK 4	C	C		P			M													
ZFK 4 - PE	C	C		P			M													
ZFK 4 - TG	C	C		P			M													
ZFK 6	C	C	C				M													
ZFK 16	C	C	C				M													
ZFK 14	C	C	C				M													
ZFKK 2.5 (-MT)	C	C	C				M													
ZFKN 4	C	C	C				M													

Schlegel

Size mm	5x10	5x10	6x10	5x10																
Marker	MG-CPM-04 41390N	MG-CPM-04 41395	MG-CPM-04 41391	MG-CPM-07 41691																
Terminal block																				
IK...	P	P	P	P																

Siemens

Size mm	5x10	5x10	5x10																	
Marker	MG-CPM-04 41390N	MG-CPM-06 41591	MG-CPM-07 41691	STF-04 42804 bracket																
Terminal block																				
8WH...	P		P																	
8WA1 011-0DF21		S		M																
8WA1 011-0DG21		S		M																
8WA1 011-1BF23		S		M																
8WA1 011-1DF11		S		M																
8WA1 011-1DG11		S		M																

Siemens

Size mm	5x10	5x10	5x10																	
Marker	MG-CPM-04 41390N	MG-CPM-06 41591	MG-CPM-07 41691	STF-04 42804 bracket																
Terminal block																				
8WA1 011-2DG11		S		M																
8WA1 011-3DF21		S		M																
8WA1 011-3DG21		S		M																
8WA1 011-1DH11		S		M																
8WA1 221		S		M																
8WA1 741-2X		S		M																
8WA2 011-1DF20		S		M																
8WA2 011-1DG20		S																		
8WA2 011-1DH20		S																		

Wago

Size mm	5x10	5x15	5x7	5x10	5x10	5x10	5x10	4,2x9												
Marker	MG-CPM-01 41090N	MG-CPM-01 41091N	MG-CPM-01 41094	MG-CPM-02 41190N	MG-CPM-03 41291	MG-CPM-03 41293	MG-CPM-04 41390N	MG-CPM-12 46390												
Terminal block																				
Top-Job 2000			C																	
Top-Job 2001			C																	
Top-Job 2002	C	S	C	S																
Top-Job 2004	C	C	C	C																
280-520					P	M	C													
280-560					P	M	C													
280-601					P	M	C													
280-607					P	M	C													
280-612					P	M	C													
280-622					P	M	C													
280-626					P	M	C													
280-641					P	M	C													
280-646					P	M	C													
280-649					P	M	C													
280-650					P	M	C													
280-651					P	M	C													
280-653					P	M	C													
280-654					P	M	C													
280-656					P	M	C													
280-671					P	M	C													
280-672					P	M	C													
280-676					P	M	C													
280-681					P	M	C													
280-683					P	M	C													
280-684					P	M	C													
280-685					P	M	C													
280-687					P	M	C													
280-695					P	M	C													
280-830					P	M	C													
280-831					P	M	C													
280-832					P	M	C													
280-833					P	M	C													
280-834					P	M	C													
280-835					P	M	C													

MG3 markers selection guide for other manufacturers' terminal blocks

Wago

Terminal block	Size mm	Marker
280-836	5x10	MG-CPM-01 41090N
280-837	5x15	MG-CPM-01 41091N
280-869	5x7	MG-CPM-01 41094
280-870	5x10	MG-CPM-02 41190N
280-871	5x10	MG-CPM-03 41291
280-874	5x10	MG-CPM-03 41293
280-875	5x10	MG-CPM-04 41390N
280-876	4,2x9	MG-CPM-12 46390
280-878		
280-880		
280-881		
280-882		
280-883		
280-884		
280-885		
280-901		
280-902		
280-903		
280-904		
280-905		
280-906		
280-907		
280-912		
280-946		
281-601		
281-604		
281-607		
281-631		
281-652		
281-653		
281-654		
281-657		
281-659		
281-660		
281-663		
281-664		
281-666		
281-668		
281-678		
281-679		
281-681		
281-683		
281-684		
281-685		
281-686		
281-687		
281-901		
281-902		
281-903		
281-904		
281-905		
281-906		
281-907		
281-912		
282-601		
282-604		
282-607		
282-681		
282-682		

Wago

Terminal block	Size mm	Marker
282-684	5x10	MG-CPM-01 41090N
282-687	5x15	MG-CPM-01 41091N
282-901	5x7	MG-CPM-01 41094
282-902	5x10	MG-CPM-02 41190N
282-904	5x10	MG-CPM-03 41291
282-907	5x10	MG-CPM-03 41293
283-602	5x10	MG-CPM-04 41390N
283-604	4,2x9	MG-CPM-12 46390
283-607		
283-609		
283-671		
283-672		
283-674		
283-677		
283-901		
283-902		
283-904		
283-907		
284-601		
284-604		
284-607		
284-681		
284-682		
284-684		
284-687		
284-901		
284-902		
284-904		
284-907		
285-601		
285-605		
290-681		
750-xxx		
769-237		
769-176		
870-501		
870-507		
870-531		
870-538		
870-551		
870-567		
870-831		
870-901		
880-901		
AKZ 4./ AKB 4...		
DLA 2.5		
DLD 2.5		
DLI 2.5		
EK 2.5		
EK 6		
EK 10		
EK 16		
EK 35		
EW15		
EW35		
EWK1		
EWK2		
IAK 1.5N 3L		
IDK 1.5		

1SNC160219S0201

MG3 markers selection guide for other manufacturers' terminal blocks

Wago

Terminal block	Size mm		Marker							
	5x10	5x15	5x7	5x10	5x10	5x10	5x10	5x10	5x10	4.2x9
IDK 1.5N	S	S	S	S	M					
IDK 1.5N/V	S	S	S	S	M					
IDU 1.5N	S	S	S	S	M					
IDU 2.5N	C	C	C	C	M					
IEK 1.5N	S	S	S	S	M					
IIK 1.5N	S	S	S	S	M					
IPE 1.5N	S	S	S	S	M					

Weidmüller

Terminal block	Size mm				Marker			
	5x10	5x15	5x7	5x10	MG-CPM-01 41090N	MG-CPM-01 41091N	MG-CPM-01 41094	MG-CPM-02 41190N
AKZ 4./AKB 4...	C	C	C	C				
DLA 2.5	P	C	C	C				
DLD 2.5	P	C	C	C				
DLI 2.5	P	C	C	C				
EK 2.5	C	C	C	C				
EK 6	CP	CP	CP	CP				
EK 10	C	C	C	C				
EK 16	C	C	C	C				
EK 35	C	C	C	C				
EW15	C	C	C	C				
EW35	C	C	C	C				
EWK1	C	C	C	C				
EWK2	C	C	C	C				
IAK 1.5N 3L	S	S	S	S				
IDK 1.5	S	S	S	S				
IDK 1.5N	S	S	S	S				
IDK 1.5N/V	S	S	S	S				
IDU 1.5N	S	S	S	S				
IDU 2.5N	P	C	C	C				
IEK 1.5N	S	S	S	S				
IIK 1.5N	S	S	S	S				
IPE 1.5N	S	S	S	S				
IPE 2.5N	C	C	C	C				
ITR 1.5N	S	S	S	S				
MAK 2.5	P	C	C	C				
Mak 2.5/VLI 1.5	P	C	C	C				
NT 4	C	C	C	C				
NT 6	CP	CP	CP	CP				
NT 10	C	C	C	C				
NT 16	C	C	C	C				
SAI-M16 / M23 in SAI-M8	C	C	C	C				
SAK 2.5	P	C	C	C				
SAK 4	C	C	C	C				
SAK 6	CP	CP	CP	CP				
SAK 10 (PA)	C	C	C	C				
SAK 16	C	C	C	C				

Weidmüller

Terminal block	Size mm				Marker			
	5x10	5x15	5x7	5x10	MG-CPM-01 41090N	MG-CPM-01 41091N	MG-CPM-01 41094	MG-CPM-02 41190N
SAK 35	C	C	C	C				
SAK 70	C	C	C	C				
SAK 95	C	C	C	C				
SAKA 10	C	C	C	C				
SAKB 10	C	C	C	C				
SAKC 4	C	C	C	C				
SAKC 10	C	C	C	C				
SAKD 2.5 N	P	S	S	S				
SAKG 28	C	C	C	C				
SAKG 32	C	C	C	C				
SAKG 40	C	C	C	C				
SAKG 46	C	C	C	C				
SAKG 54	C	C	C	C				
SAKG 70	C	C	C	C				
SAKR	C	C	C	C				
SAKRD	C	C	C	C				
SAKS 1	C	C	C	C				
SAKS 2	C	C	C	C				
SAKS 3	C	C	C	C				
SAKS 4	C	C	C	C				
SAKS 5	C	C	C	C				
SAKT 1	CP	CP	CP	CP				
SAKT 2	CP	CP	CP	CP				
SAKT 4	C	C	C	C				
SS 6	C	C	C	C				
SS 8	C	C	C	C				
SS 10	C	C	C	C				
SS 12	C	C	C	C				
TOP 2.5	P	C	C	C				
TOP 4	C	C	C	C				
VLI 2.5	P	C	C	C				
WDK 2.5	P	S	S	S				
WDK 2.5 800V	P	C	C	C				
WDK 2.5N	P	S	S	S				
WDK 4N	C	C	C	C				
WDL 2.5	P	C	C	C				
WDL 2.5 / S	P	C	C	C				
WDT 1.5	C	C	C	C				
WDTR 2.5	P	C	C	C				
WDU 1.5	S	S	S	S				
WDU 1.5 BLA	S	S	S	S				
WDU 1.5 LD/BLA	S	S	S	S				
WDU 1.5/BLZ 5.08	S	S	S	S				
WDU 1.5/BLZ R7.62	S	S	S	S				
WDU 1.5/BLZ/LD/5.08	S	S	S	S				
WDU 1.5ZZ	S	S	S	S				
WDU 2.5	P	S	S	S				
WDU 2.5 F	P	S	S	S				
WDU 2.5 FF	P	S	S	S				
WDU 2.5 N	P	S	S	S				
WDU 2.5 TC	P	S	S	S				
WDU 2.5/1.5/ZZ	P	S	S	S				
WDU 4	C	C	C	C				
WDU 4N	C	C	C	C				
WDU 6	C	C	C	C				
WDU 10	C	C	C	C				
WDU 10SL	C	C	C	C				
WDU 16	C	C	C	C				
WDU 35 N	C	C	C	C				

MG3 markers selection guide for other manufacturers' terminal blocks

Weidmüller

Terminal block	Size mm			
	5x10	5x15	5x7	5x10
Marker	MG-CPM-01 41090N	MG-CPM-01 41091N	MG-CPM-01 41094	MG-CPM-02 41190N
WDU 70/95	C	C	C	C
WDU 95N	C	C	C	C
WDU 120/150	C	C	C	C
WDU 240	C	C	C	C
WFF 35	C	C	C	C
WFF 70	C	C	C	C
WFF 120	C	C	C	C
WFF 185	C	C	C	C
WFF 300	C	C	C	C
WIN BLOCK	C	C	C	C
WNT 2.5	P	S	S	S
WNT 4	C	C	C	C
WNT 6	C	C	C	C
WNT 10	C	C	C	C
WPE 1.5	S	S	S	S
WPE 1.5/ZZ	S	S	S	S
WPE 2.5	P	S	S	S
WPE 2.5/1.5/ZR	P	C	C	C
WPE 4	C	C	C	C
WPE 6	C	C	C	C
WPE 10	C	C	C	C
WPE 16	C	C	C	C
WPE 35	C	C	C	C
WSI 6	C	C	C	C
WSI 6/2	C	C	C	C
WTL 6/1	C	C	C	C
WTL 6/2	CP	CP	CP	CP
WTR 2.5	P	C	C	C
ZBLD 2.5/1.5	P	C	C	C
ZDK 2.5/1.5	P	C	C	C
ZDK 2.5/1.5 DU-PE	P	C	C	C
ZDK 2.5/1.5 N-PE	P	C	C	C
ZDK 2.5/1.5 V / E	P	C	C	C
ZDK 2.5/1.5/E	P	C	C	C
ZDK 2.5/1.5/E BL	P	C	C	C
ZDK 2.5/1.5/LD/1	P	C	C	C
ZDK 2.5/1.5/LD/2	P	C	C	C
ZDK 2.5/1.5/N-PE/E	P	C	C	C
ZDK 2.5/1.5D1...6	P	C	C	C
ZDK 2.5/1.5N-DU	P	C	C	C
ZDK 2.5/1.5N-DU/E	P	C	C	C
ZDK 2.5/1.5N-DU-PE/E	P	C	C	C
ZDK 2.5/1.5PE	P	C	C	C
ZDK 2.5/1.5V	P	C	C	C
ZDKB	C	C	C	C
ZDKS	C	C	C	C
ZDL 2.5 / 1.5	P	C	C	C
ZDL 2.5 / 1.5 V	P	C	C	C
ZDU 2.5 2.5/10	P	C	C	C
ZDU 2.5/2x2AN	P	C	C	C
ZDU 2.5/2x2AN (/E) BL	P	C	C	C
ZDU 2.5/2x2AN/10	P	C	C	C
ZDU 2.5/2x2AN/D	P	C	C	C
ZDU 2.5/2x2AN/E	P	C	C	C
ZDU 2.5/2x2AN/LD	P	C	C	C
ZDU 2.5/3AN	P	C	C	C
ZDU 2.5/3AN (/E) BL	P	C	C	C
ZDU 2.5/3AN/10	P	C	C	C
ZDU 2.5/3AN/E	P	C	C	C

Weidmüller

Terminal block	Size mm			
	5x10	5x15	5x7	5x10
Marker	MG-CPM-01 41090N	MG-CPM-01 41091N	MG-CPM-01 41094	MG-CPM-02 41190N
ZDU 2.5/4AN	P	C	C	C
ZDU 2.5/4AN (/E) BL	P	C	C	C
ZDU 2.5/4AN/10	P	C	C	C
ZDU 2.5-2/3	P	C	C	C
ZDU 2.5-2/3AN (/E) BL	P	C	C	C
ZDU 2.5-2/4AN (/E)	P	C	C	C
ZDU 2.5-2/3AN (/E) BL	C	C	C	C
ZDU 2.5-2/4AN (/E)	C	C	C	C
ZDU 2.5-2/4AN (/E) BL	P	C	C	C
ZDU 2.5 (/E)	P	C	C	C
ZDU 2.5 (/E) BL	P	C	C	C
ZDU 2.5-2	P	C	C	C
ZDU 4	C	C	C	C
ZDU 6	CP	CP	CP	CP
ZDU 10 NT	C	C	C	C
ZDU 16 16/3AN	C	C	C	C
ZDU 35	C	C	C	C
ZDUA 2.5-2 (/E)	P	C	C	C
ZDUA 2.5-2 (/E) BL	P	C	C	C
ZDUB 2.5 / 2-2/4AN	P	C	C	C
ZDUB 2.5 / 2AN	P	C	C	C
ZDUB 2.5-2/2AN	P	C	C	C
ZIA 1.5/....	C	C	C	C
ZK3S	C	C	C	C
ZKB	C	C	C	C
ZKS	C	C	C	C
ZPE 2.5/4AN	P	C	C	C
ZPE 2.5	P	C	C	C
ZPE 2.5/3AN	P	C	C	C
ZPE 2.5/3AN/E	P	C	C	C
ZPE 2.5/4AN	P	C	C	C
ZPE 2.5/4AN/E	P	C	C	C
ZPE 2.5/E	P	C	C	C
ZPE 2.5-2 (/E)	P	C	C	C
ZPE 2.5-2/3AN	P	C	C	C
ZPE 2.5-2/3AN/E	P	C	C	C
ZPE 2.5-2/4AN	P	C	C	C
ZPE 35	C	C	C	C
ZPEA -2/E	C	C	C	C
ZRV 1.5	C	C	C	C
ZRV 1.5PE	C	C	C	C
ZSI 2.5	P	C	C	C
ZSI 2.5/2	P	C	C	C
ZSLD 2.5/1.5	P	C	C	C
ZTR 2.5	P	C	C	C
ZTR 2.5 D	P	C	C	C
ZTR 2.5/3AN	P	C	C	C
ZVL 1.5	C	C	C	C

MG3 markers selection guide for other manufacturers' terminal blocks

Wieland

	Size mm		Marker																	
	5x10	5x10	MG-CPM-05 41490	MG-CPM-05 41494																
				STF-05 42805 bracket																
Terminal block																				
WT 2,5	P	M	M																	
WT 4	C	C	M																	
WT 6	C	C	M																	
WT 10	C	C	M																	
WT 16	C	C	M																	
WTP 2,5/4	P	M	M																	
WTP 6/10	C	C	M																	
WK 2,5/ U	P	M	M																	
WK 4/ U	C	C	M																	
WK 6/ U	C	C	M																	
WK 8/ U	C	C	M																	
WK 10/ U	C	C	M																	
WK 25/ U	C	C	M																	
WK 35/ U	C	C	M																	

Woertz

	Size mm		Marker																		
	3x10	5x10	5x10	5x7																	
Terminal block																					
30544 / 4 V	C	C	C	C																	
30544 / 6 V	C	C	C	C																	
30544 / 10 V	C	CP	CP	CP																	
30800	C	C	C	C																	
30840	C	C	C	C																	
30841	C	C	C	C																	
30842	C	C	C	C																	
30843	C	C	C	C																	
30844	C	C	C	C																	

HTP500 markers selection guide for other manufacturers' terminal blocks

Terminal block

Terminal block markers are available in versions to suit the particular terminal block formats of the most widely used products, see selection guide to side.

Depending on type, markers are presented as joined strips at a set or as separate markers for convenient individual insertion on mixed spacing terminal block assemblies.

Markers

Strip markers

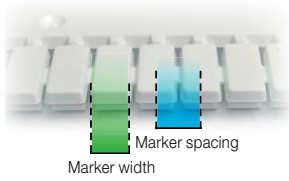

Individual markers

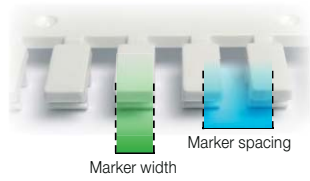

S - Strip mounting



Marker spacing = Terminal block spacing

I - Individual mounting

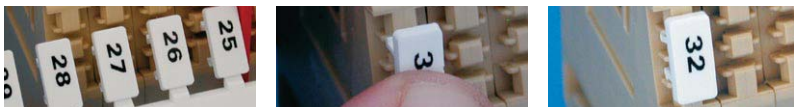

Marker spacing \neq Terminal block spacing

T - Top mounting

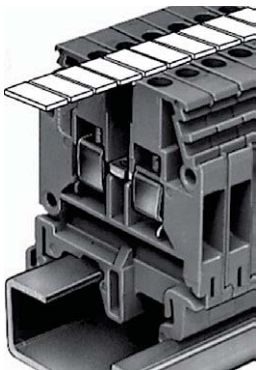

HTP500 markers selection guide for other manufacturers' terminal blocks

Size mm	5x10	5x10	5x10
Marker	FCW510 - 1SNA235096R1700	PCP510 - 1SNA235095R1600	FCL510 - 1SNA235097R1000

Terminal block

Arnocanali

CTS2,5UN			
CTS4UN			
CTS6U			
CTS10U			
CTS16U			
CTS35U			
CSCG2,5T			
CSCG4T			
CSCG6T			
CSCG10T			
CSFL4U			
CSC2,5T			
CSC4T			
CSC6T			
CSC10T			
CA702			
CA802			
CGT4N			
CGT6N			
CGT4U			
CGT10U			
CGT35U			

Entrelec

M2,5/5			
M4/6			

Contaclip

RK 2,5	S		
RK 2,5/35	S		
RK 2,54	I		
RKD 2,5	S		
RKD 2,5/35	S		
RKD 4	I		
RK 4...RK 240	I		
SRK 2,5/15	S		
SRK 2,5	S		
IK 2,5	S		
IKD 2,5	S		
BKA 2,5	S		
KBL 2,5	S		
SL 4...SL 35	I		
TSK...	I		
FF...	I		
STK...	I		
SIK...	I		
PTK...	I		
TRK...	I		
ES...	I		
EH...	I		
ZSRK2,5...	S		
ZRK2,5...	S		
ZSLN 2,5	S		
ZSL 2,5	S		
ZIKD 2,5...	S		
ZSLD 2,5...	S		

Size mm	5x10	5x10	5x10
Marker	FCW510 - 1SNA235096R1700	PCP510 - 1SNA235095R1600	FCL510 - 1SNA235097R1000

Terminal block

Contaclip (cont.)

ZRKD 2,5...	S		
ZTRK 2,5...	S		
ZIZA 1,5...	S		
ZRK 4...ZRK 16	I		
ZSL 4...ZSL 16	I		
FRK 2,5...	S		
FSL 2,5...	S		
FRKD 2,5...	S		
FDLIS	S		
FRK 4	I		
FSL4	I		

Klemsan

AVK 2,5	S		
AVK 4	I		
AVK 6	I		
AVK 10	I		

Legrand

10A		I	
20A		I	
25A		S	
35A		I	
50A		I	
70A		I	
396,2857143		S	
390 81		S	

Phoenix

ST 2,5		ST	
ST 4		IT	
ST 6		IT	
UT 2,5		S	
UT 4		I	
UT 6		I	
UK 2,5		S	
UK 3		I	
UK 5		I	
UK 5N		I	
UKK 3		S	
UKK 5		I	
PIK 4PE/L/NL		I	
PIK 4L/L		I	

Rockwell Automation

1492 K3	I		
1492 J3	S		
1492 L3	S		
1492 J4	I		
1492 JD3C	S		

Siemens

8WH2		IT	
8WH3		IT	
8WH4		IT	
8WH5		IT	

Size mm	5x10	5x10	5x10
Marker	FCW510 - 1SNA235096R1700	PCP510 - 1SNA235095R1600	FCL510 - 1SNA235097R1000

Terminal block

Staffel

TAC 10			
--------	--	--	--

Télé mécanique

AB1RR435U2			S
WK 4SL/U		I	
WK 4E/U			S
WK 4/THS15		I	
WK 4/U			S
WK 6SL/U		I	
WK 10/SIU		I	
WKN 16/U		I	

Wago

280		I	
281		I	
282		I	
283		I	
284		I	
290		I	

Weidmüller

SAK 2,5	I		
SAK 4	I		
SAK 6	I		
WDU 1,5	I		
WDU 2,5	S		
WDU 4	I		
WDU 6	I		
WDU 10	I		
WDU 35	I		
ZDU 2,5	S		
ZDU 6	I		
WSI 6	I		
WTR 2,5	S		
WPE 2,5	S		
WPE 4	I		
ZPE 2,5	S		
WNT 2,5	S		
WDK 2,5	S		
WDK 4	I		

Woertz

30301			S
30145		I	
30150		I	
3450			S
3430			S

I = individual mounting

S = strip mounting

T = top mounting

Index

Part Number classification

Part Number	Type	Page	Part Number	Type	Page	Part Number	Type	Page
1SFA616920R8120	KA1-8120	35	1SNA229153R0600	RC410	127	1SNA230034R2700	RC55	144
1SNA103115R1300	RTM7	154	1SNA229154R0700	RC410	127	1SNA230035R2000	RC55	144
1SNA103116R1400	RTM7	154	1SNA229155R0000	RC410	127	1SNA230036R2100	RC55	144
1SNA103775R0000	RC65	86	1SNA229156R0100	RC410	127	1SNA230037R2200	RC55	144
1SNA103776R0100	RC65	86	1SNA229157R0200	RC410	127	1SNA230038R0300	RC55	144
1SNA103890R2100	RC510-YL	85	1SNA229158R1300	RC410	127	1SNA230039R0400	RC55	144
1SNA103922R1400	RTM7	154	1SNA229159R1400	RC410	127	1SNA230040R1100	RC55	146
1SNA107033R1000	EPU5	156	1SNA229160R1100	RC410	127	1SNA230041R0600	RC55	146
1SNA107038R2500	EPU6	156	1SNA229161R0600	RC410	127	1SNA230042R0700	RC55	146
1SNA113077R1100	PEB	31	1SNA229162R0700	RC410	127	1SNA230043R0000	RC55	146
1SNA113084R0100	PEBM	31	1SNA229163R0000	RC410	127	1SNA230044R0100	RC55	146
1SNA113180R1200	PEV	89	1SNA229164R0100	RC410	127	1SNA230045R0200	RC55	146
1SNA163007R2600	RPEH	95	1SNA229165R0200	RC410	127	1SNA230046R0300	RC55	146
1SNA163155R2600	REH3	91	1SNA229166R0300	RC410	127	1SNA230047R0400	RC55	146
1SNA163167R2200	REH3	95	1SNA229167R0400	RC410	127	1SNA230048R1500	RC55	146
1SNA163211R2600	PEH	95	1SNA229168R1500	RC410	127	1SNA230049R1600	RC55	146
1SNA163427R1700	EP6	157	1SNA229169R1600	RC410	127	1SNA230050R1300	RC55	146
1SNA163428R2000	EP8	157	1SNA229170R1300	RC410	127	1SNA230051R0000	RC55	146
1SNA163429R2100	EP10	157	1SNA229171R0000	RC410	127	1SNA230052R0100	RC55	146
1SNA163430R2600	EP12	157	1SNA229172R0100	RC410	127	1SNA230053R0200	RC55	146
1SNA163431R1300	EP16	157	1SNA229173R0200	RC410	127	1SNA230054R0300	RC55	146
1SNA163432R1400	VSP12	157	1SNA229174R0300	RC410	127	1SNA230055R0400	RC55	146
1SNA163433R1500	VSP6	157	1SNA229175R0400	RC410	127	1SNA230056R0500	RC55	146
1SNA164602R0000	RTM9	90	1SNA229180R0600	RC410	129	1SNA230057R0600	RC55	146
1SNA164695R2500	REH3	155	1SNA229181R2300	RC410	129	1SNA230058R1700	RC55	146
1SNA168410R0700	RTM7	90	1SNA229182R2400	RC410	129	1SNA230059R1000	RC55	146
1SNA168737R0200	PETC 51	103	1SNA229183R2500	RC410	129	1SNA230060R1500	RC55	146
1SNA168741R1600	PETC 53	103	1SNA229184R2600	RC410	129	1SNA230061R0200	RC55	146
1SNA168747R1400	PETC 56	103	1SNA229185R2700	RC410	129	1SNA230062R0300	RC55	146
1SNA173147R2000	VSP16	157	1SNA229186R2000	RC410	129	1SNA230063R0400	RC55	146
1SNA173178R0700	RPEV	89	1SNA229187R2100	RC410	129	1SNA230064R0500	RC55	146
1SNA173327R2400	EP223	157	1SNA229188R0200	RC410	129	1SNA230065R0600	RC55	146
1SNA173328R0500	EP224	157	1SNA229189R0300	RC410	129	1SNA230066R0700	RC55	146
1SNA173812R1300	PIB	96	1SNA229190R0000	RC410	129	1SNA230067R0000	RC55	146
1SNA178430R0500	RCPEB	96	1SNA229191R2500	RC410	129	1SNA230068R1100	RC55	146
1SNA178431R2200	EPR1	31	1SNA229192R2600	RC410	129	1SNA230069R1200	RC55	146
1SNA206103R0700	VSP68	157	1SNA229193R2700	RC410	129	1SNA230072R0500	RC55	146
1SNA206230R1100	RC610	85	1SNA229194R2000	RC410	129	1SNA230111R2100	RC55	145
1SNA206231R0600	RC610	85	1SNA229195R2100	RC410	129	1SNA230112R2200	RC55	145
1SNA206232R0700	RC610	85	1SNA229196R2200	RC410	129	1SNA230113R2300	RC55	145
1SNA206233R0000	RC610	85	1SNA229197R2300	RC410	129	1SNA230114R2400	RC55	145
1SNA206234R0100	RC610	85	1SNA229198R0400	RC410	129	1SNA230115R2500	RC55	145
1SNA206235R0200	RC610	85	1SNA229199R0500	RC410	129	1SNA230116R2600	RC55	145
1SNA229000R1500	RC410	85	1SNA229200R2200	RC410	129	1SNA230117R2700	RC55	145
1SNA229001R0200	RC410	126	1SNA229201R1700	RC410	129	1SNA230118R0000	RC55	145
1SNA229002R0300	RC410	126	1SNA229202R1000	RC410	129	1SNA230119R0100	RC55	145
1SNA229003R0400	RC410	126	1SNA229203R1100	RC410	129	1SNA230131R2500	RC55	145
1SNA229004R0500	RC410	126	1SNA229204R1200	RC410	129	1SNA230150R1400	RC55	145
1SNA229005R0600	RC410	126	1SNA229205R1300	RC410	129	1SNA230151R0100	RC55	145
1SNA229006R0700	RC410	126	1SNA229210R1300	RC410	126	1SNA230152R0200	RC55	145
1SNA229007R0000	RC410	126	1SNA229211R0000	RC410	126	1SNA230153R0300	RC55	145
1SNA229008R1100	RC410	126	1SNA229212R0100	RC410	126	1SNA230154R0400	RC55	145
1SNA229009R1200	RC410	126	1SNA229213R0200	RC410	126	1SNA230155R0500	RC55	145
1SNA229010R0600	RC410	126	1SNA229214R0300	RC410	126	1SNA230156R0600	RC55	145
1SNA229011R2300	RC410	126	1SNA229215R0400	RC410	126	1SNA230157R0700	RC55	145
1SNA229030R0200	RC410	126	1SNA229216R0500	RC410	126	1SNA230158R1000	RC55	145
1SNA229040R1400	RC410	128	1SNA229217R0600	RC410	126	1SNA230159R1100	RC55	145
1SNA229041R0100	RC410	128	1SNA229218R1700	RC410	126	1SNA230160R1600	RC55	145
1SNA229042R0200	RC410	128	1SNA229220R1500	RC410	126	1SNA230161R0300	RC55	145
1SNA229043R0300	RC410	128	1SNA229221R0200	RC410	126	1SNA230162R0400	RC55	145
1SNA229044R0400	RC410	128	1SNA229222R0300	RC410	126	1SNA230163R0500	RC55	145
1SNA229045R0500	RC410	128	1SNA229223R0400	RC410	126	1SNA230164R0600	RC55	145
1SNA229046R0600	RC410	128	1SNA229224R0500	RC410	126	1SNA230165R0700	RC55	145
1SNA229047R0700	RC410	128	1SNA229225R0600	RC410	126	1SNA230166R0000	RC55	145
1SNA229048R1000	RC410	128	1SNA229226R0700	RC410	126	1SNA230167R0100	RC55	145
1SNA229049R1100	RC410	128	1SNA229227R0000	RC410	126	1SNA230168R1200	RC55	145
1SNA229050R1600	RC410	128	1SNA229228R1100	RC410	126	1SNA230169R1300	RC55	145
1SNA229051R0300	RC410	128	1SNA229229R1200	RC410	126	1SNA230170R1000	RC55	145
1SNA229052R0400	RC410	128	1SNA229230R1700	RC410	126	1SNA230171R0500	RC55	145
1SNA229053R0500	RC410	128	1SNA230000R1200	RC55	86	1SNA230172R0600	RC55	145
1SNA229054R0600	RC410	128	1SNA230001R0700	RC55	144	1SNA230173R0700	RC55	145
1SNA229055R0700	RC410	128	1SNA230002R0000	RC55	144	1SNA230174R0000	RC55	145
1SNA229056R0000	RC410	128	1SNA230003R0100	RC55	144	1SNA230175R0100	RC55	145
1SNA229057R0100	RC410	128	1SNA230004R0200	RC55	144	1SNA230180R0300	RC55	146
1SNA229058R1200	RC410	128	1SNA230005R0300	RC55	144	1SNA230181R2000	RC55	146
1SNA229059R1300	RC410	128	1SNA230006R0400	RC55	144	1SNA230182R2100	RC55	146
1SNA229060R1000	RC410	128	1SNA230007R0500	RC55	144	1SNA230183R2200	RC55	146
1SNA229061R0500	RC410	128	1SNA230008R1600	RC55	144	1SNA230184R2300	RC55	146
1SNA229062R0600	RC410	128	1SNA230009R1700	RC55	144	1SNA230185R2400	RC55	146
1SNA229063R0700	RC410	128	1SNA230010R0300	RC55	144	1SNA230186R2500	RC55	146
1SNA229064R0000	RC410	128	1SNA230011R2000	RC55	144	1SNA230187R2600	RC55	146
1SNA229065R0100	RC410	128	1SNA230012R2100	RC55	144	1SNA230188R0700	RC55	146
1SNA229066R0200	RC410	128	1SNA230013R2200	RC55	144	1SNA230189R0000	RC55	146
1SNA229067R0300	RC410	128	1SNA230014R2300	RC55	144	1SNA230190R0500	RC55	146
1SNA229068R1400	RC410	128	1SNA230015R2400	RC55	144	1SNA230191R2200	RC55	146
1SNA229069R1500	RC410	128	1SNA230016R2500	RC55	144	1SNA230192R2300	RC55	146
1SNA229072R0000	RC410	128	1SNA230017R2600	RC55	144	1SNA230193R2400	RC55	146
1SNA229111R2400	RC410	127	1SNA230018R0700	RC55	144	1SNA230194R2500	RC55	146
1SNA229112R2500	RC410	127	1SNA230019R0000	RC55	144	1SNA230195R2600	RC55	146
1SNA229113R2600	RC410	127	1SNA230020R0500	RC55	144	1SNA230196R2700	RC55	146
1SNA229114R2700	RC410	127	1SNA230021R2200	RC55	144	1SNA230197R2000	RC55	146
1SNA229115R2000	RC410	127	1SNA230030R0700	RC55	144	1SNA230198R0100	RC55	146
1SNA229150R1700	RC410	127	1SNA230031R2400	RC55	144	1SNA230199R0200	RC55	146
1SNA229151R0400	RC410	127	1SNA230032R2500	RC55	144	1SNA230200R2700	RC55	146
1SNA229152R0500	RC410	127	1SNA230033R2600	RC55	144	1SNA230201R1400	RC55	146

Index

Part Number classification

Part Number	Type	Page	Part Number	Type	Page	Part Number	Type	Page
1SNA2320202R1500	RC55	146	1SNA231119R2600	RC510	131	1SNA232014R1100	RC65	147
1SNA2320203R1600	RC55	146	1SNA231131R1200	RC510	131	1SNA232015R1200	RC65	147
1SNA2320204R1700	RC55	146	1SNA231133R1400	RC510	132	1SNA232016R1300	RC65	147
1SNA2320205R1000	RC55	146	1SNA231134R1500	RC510	132	1SNA232017R1400	RC65	147
1SNA2320240R2600	RC55	144	1SNA231135R1600	RC510	132	1SNA232018R2500	RC65	147
1SNA2320241R1300	RC55	144	1SNA231136R1700	RC510	132	1SNA232019R2600	RC65	147
1SNA2320242R1400	RC55	144	1SNA231137R1000	RC510	132	1SNA232020R2300	RC65	147
1SNA2320243R1500	RC55	144	1SNA231150R0100	RC510	131	1SNA232021R1000	RC65	147
1SNA2320244R1600	RC55	144	1SNA231151R2600	RC510	131	1SNA232030R2500	RC65	147
1SNA2320245R1700	RC55	144	1SNA231152R2700	RC510	131	1SNA232031R1200	RC65	147
1SNA2320246R1000	RC55	144	1SNA231153R2000	RC510	131	1SNA232032R1300	RC65	147
1SNA2320247R1100	RC55	144	1SNA231154R2100	RC510	131	1SNA232033R1400	RC65	147
1SNA2320248R2200	RC55	144	1SNA231155R2200	RC510	131	1SNA232034R1500	RC65	147
1SNA2320250R2000	RC55	144	1SNA231156R2300	RC510	131	1SNA232035R1600	RC65	147
1SNA2320251R1500	RC55	144	1SNA231157R2400	RC510	131	1SNA232036R1700	RC65	147
1SNA2320252R1600	RC55	144	1SNA231158R0500	RC510	131	1SNA232037R1000	RC65	147
1SNA2320253R1700	RC55	144	1SNA231159R0600	RC510	131	1SNA232038R2100	RC65	147
1SNA2320254R1000	RC55	144	1SNA231160R0300	RC510	131	1SNA232039R2200	RC65	147
1SNA2320255R1100	RC55	144	1SNA231161R2000	RC510	131	1SNA232040R0700	RC65	149
1SNA2320256R1200	RC55	144	1SNA231162R2100	RC510	131	1SNA232041R2400	RC65	149
1SNA2320257R1300	RC55	144	1SNA231163R2200	RC510	131	1SNA232042R2500	RC65	149
1SNA2320258R2400	RC55	144	1SNA231164R2300	RC510	131	1SNA232043R2600	RC65	149
1SNA2320259R2500	RC55	144	1SNA231165R2400	RC510	131	1SNA232044R2700	RC65	149
1SNA2320260R2200	RC55	144	1SNA231166R2500	RC510	131	1SNA232045R2000	RC65	149
1SNA231000R0700	RC510	85	1SNA231167R2600	RC510	131	1SNA232046R2100	RC65	149
1SNA231001R2400	RC510	130	1SNA231168R0700	RC510	131	1SNA232047R2200	RC65	149
1SNA231002R2500	RC510	130	1SNA231169R0000	RC510	131	1SNA232048R0300	RC65	149
1SNA231003R2600	RC510	130	1SNA231170R0500	RC510	131	1SNA232049R0400	RC65	149
1SNA231004R2700	RC510	130	1SNA231171R2200	RC510	131	1SNA232050R0100	RC65	149
1SNA231005R2000	RC510	130	1SNA231172R2300	RC510	131	1SNA232051R2600	RC65	149
1SNA231006R2100	RC510	130	1SNA231173R2400	RC510	131	1SNA232052R2700	RC65	149
1SNA231007R2200	RC510	130	1SNA231174R2500	RC510	131	1SNA232053R2000	RC65	149
1SNA231008R0300	RC510	130	1SNA231175R2600	RC510	131	1SNA232054R2100	RC65	149
1SNA231009R0400	RC510	130	1SNA231180R2000	RC510	133	1SNA232055R2200	RC65	149
1SNA231010R2000	RC510	130	1SNA231181R1500	RC510	133	1SNA232056R2300	RC65	149
1SNA231011R1500	RC510	130	1SNA231182R1600	RC510	133	1SNA232057R2400	RC65	149
1SNA231012R1600	RC510	130	1SNA231183R1700	RC510	133	1SNA232058R0500	RC65	149
1SNA231013R1700	RC510	130	1SNA231184R1000	RC510	133	1SNA232059R0600	RC65	149
1SNA231014R1000	RC510	130	1SNA231185R1100	RC510	133	1SNA232060R0300	RC65	149
1SNA231015R1100	RC510	130	1SNA231186R1200	RC510	133	1SNA232061R2000	RC65	149
1SNA231016R1200	RC510	130	1SNA231187R1300	RC510	133	1SNA232062R2100	RC65	149
1SNA231017R1300	RC510	130	1SNA231188R2400	RC510	133	1SNA232063R2200	RC65	149
1SNA231018R2400	RC510	130	1SNA231189R2500	RC510	133	1SNA232064R2300	RC65	149
1SNA231019R2500	RC510	130	1SNA231190R2200	RC510	133	1SNA232065R2400	RC65	149
1SNA231020R2200	RC510	130	1SNA231191R1700	RC510	133	1SNA232066R2500	RC65	149
1SNA231021R1700	RC510	130	1SNA231192R1000	RC510	133	1SNA232067R2600	RC65	149
1SNA231030R2400	RC510	130	1SNA231193R1100	RC510	133	1SNA232068R0700	RC65	149
1SNA231031R1100	RC510	130	1SNA231194R1200	RC510	133	1SNA232069R0000	RC65	149
1SNA231032R1200	RC510	130	1SNA231195R1300	RC510	133	1SNA232072R2300	RC65	149
1SNA231033R1300	RC510	130	1SNA231196R1400	RC510	133	1SNA232111R1700	RC65	148
1SNA231034R1400	RC510	130	1SNA231197R1500	RC510	133	1SNA232112R1000	RC65	148
1SNA231035R1500	RC510	130	1SNA231198R2600	RC510	133	1SNA232113R1100	RC65	148
1SNA231036R1600	RC510	130	1SNA231199R2700	RC510	133	1SNA232114R1200	RC65	148
1SNA231037R1700	RC510	130	1SNA231200R1400	RC510	133	1SNA232115R1300	RC65	148
1SNA231038R2000	RC510	130	1SNA231201R0100	RC510	133	1SNA232116R1400	RC65	148
1SNA231039R2100	RC510	130	1SNA231202R0200	RC510	133	1SNA232117R1500	RC65	148
1SNA231040R0600	RC510	132	1SNA231203R0300	RC510	133	1SNA232118R2600	RC65	148
1SNA231041R2300	RC510	132	1SNA231204R0400	RC510	133	1SNA232119R2700	RC65	148
1SNA231042R2400	RC510	132	1SNA231205R0500	RC510	133	1SNA232131R1300	RC65	148
1SNA231043R2500	RC510	132	1SNA231210R0500	RC510	130	1SNA232132R1400	RC65	148
1SNA231044R2600	RC510	132	1SNA231211R2200	RC510	130	1SNA232133R1500	RC65	148
1SNA231045R2700	RC510	132	1SNA231212R2300	RC510	130	1SNA232134R1600	RC65	148
1SNA231046R2000	RC510	132	1SNA231213R2400	RC510	130	1SNA232135R1700	RC65	148
1SNA231047R2100	RC510	132	1SNA231214R2500	RC510	130	1SNA232136R1000	RC65	148
1SNA231048R0200	RC510	132	1SNA231215R2600	RC510	130	1SNA232137R1100	RC65	148
1SNA231049R0300	RC510	132	1SNA231216R2700	RC510	130	1SNA232150R0200	RC65	148
1SNA231050R0000	RC510	132	1SNA231217R2000	RC510	130	1SNA232151R2700	RC65	148
1SNA231051R2500	RC510	132	1SNA231218R0100	RC510	130	1SNA232152R2000	RC65	148
1SNA231052R2600	RC510	132	1SNA231220R0700	RC510	130	1SNA232153R2100	RC65	148
1SNA231053R2700	RC510	132	1SNA231221R2400	RC510	130	1SNA232154R2200	RC65	148
1SNA231054R2000	RC510	132	1SNA231222R2500	RC510	130	1SNA232155R2300	RC65	148
1SNA231055R2100	RC510	132	1SNA231223R2600	RC510	130	1SNA232156R2400	RC65	148
1SNA231056R2200	RC510	132	1SNA231224R2700	RC510	130	1SNA232157R2500	RC65	148
1SNA231057R2300	RC510	132	1SNA231225R2000	RC510	130	1SNA232158R0600	RC65	148
1SNA231058R0400	RC510	132	1SNA231226R2100	RC510	130	1SNA232159R0700	RC65	148
1SNA231059R0500	RC510	132	1SNA231227R2200	RC510	130	1SNA232160R0400	RC65	148
1SNA231060R0200	RC510	132	1SNA231228R0300	RC510	130	1SNA232161R2100	RC65	148
1SNA231061R2700	RC510	132	1SNA231229R0400	RC510	130	1SNA232162R2200	RC65	148
1SNA231062R2000	RC510	132	1SNA231230R0100	RC510	130	1SNA232163R2300	RC65	148
1SNA231063R2100	RC510	132	1SNA231230R0100	RC510TT	17	1SNA232164R2400	RC65	148
1SNA231064R2200	RC510	132	1SNA231700R1100	RC510TT-YL	17	1SNA232165R2500	RC65	148
1SNA231065R2300	RC510	132	1SNA232000R0000	RC65	86	1SNA232166R2600	RC65	148
1SNA231066R2400	RC510	132	1SNA232001R2500	RC65	147	1SNA232167R2700	RC65	148
1SNA231067R2500	RC510	132	1SNA232002R2600	RC65	147	1SNA232168R0000	RC65	148
1SNA231068R0600	RC510	132	1SNA232003R2700	RC65	147	1SNA232169R0100	RC65	148
1SNA231069R0700	RC510	132	1SNA232004R2000	RC65	147	1SNA232170R0600	RC65	148
1SNA231072R2200	RC510	132	1SNA232005R2100	RC65	147	1SNA232171R2300	RC65	148
1SNA231111R1600	RC510	131	1SNA232006R2200	RC65	147	1SNA232172R2400	RC65	148
1SNA231112R1700	RC510	131	1SNA232007R2300	RC65	147	1SNA232173R2500	RC65	148
1SNA231113R1000	RC510	131	1SNA232008R0400	RC65	147	1SNA232174R2600	RC65	148
1SNA231114R1100	RC510	131	1SNA232009R0500	RC65	147	1SNA232175R2700	RC65	148
1SNA231115R1200	RC510	131	1SNA232010R2100	RC65	147	1SNA232180R2100	RC65	150
1SNA231116R1300	RC510	131	1SNA232011R1600	RC65	147	1SNA232181R1600	RC65	150
1SNA231117R1400	RC510	131	1SNA232012R1700	RC65	147	1SNA232182R1700	RC65	150
1SNA231118R2500	RC510	131	1SNA232013R1000	RC65	147	1SNA232183R1000	RC65	150



Index

Part Number classification

Part Number	Type	Page	Part Number	Type	Page	Part Number	Type	Page
1SNA232184R1100	RC65	150	1SNA233033R1500	RC610	135	1SNA233158R0700	RC610	136
1SNA232185R1200	RC65	150	1SNA233034R1600	RC610	135	1SNA233159R0000	RC610	136
1SNA232186R1300	RC65	150	1SNA233035R1700	RC610	135	1SNA233160R0500	RC610	136
1SNA232187R1400	RC65	150	1SNA233036R1000	RC610	135	1SNA233161R2200	RC610	136
1SNA232188R2500	RC65	150	1SNA233040R0000	RC610	137	1SNA233162R2300	RC610	136
1SNA232189R2600	RC65	150	1SNA233041R2500	RC610	137	1SNA233163R2400	RC610	136
1SNA232190R2300	RC65	150	1SNA233042R2600	RC610	137	1SNA233164R2500	RC610	136
1SNA232191R1000	RC65	150	1SNA233043R2700	RC610	137	1SNA233165R2600	RC610	136
1SNA232192R1100	RC65	150	1SNA233044R2000	RC610	137	1SNA233166R2700	RC610	136
1SNA232193R1200	RC65	150	1SNA233045R2100	RC610	137	1SNA233167R2000	RC610	136
1SNA232194R1300	RC65	150	1SNA233046R2200	RC610	137	1SNA233168R0100	RC610	136
1SNA232195R1400	RC65	150	1SNA233047R2300	RC610	137	1SNA233169R0200	RC610	136
1SNA232196R1500	RC65	150	1SNA233048R0400	RC610	137	1SNA233170R0700	RC610	136
1SNA232197R1600	RC65	150	1SNA233049R0500	RC610	137	1SNA233171R2400	RC610	136
1SNA232198R2700	RC65	150	1SNA233050R0200	RC610	137	1SNA233172R2500	RC610	136
1SNA232199R2000	RC65	150	1SNA233051R2700	RC610	137	1SNA233173R2600	RC610	136
1SNA232200R1500	RC65	150	1SNA233060R0400	RC610	137	1SNA233174R2700	RC610	136
1SNA232201R0200	RC65	147	1SNA233061R2100	RC610	137	1SNA233175R2000	RC610	136
1SNA232202R0300	RC65	147	1SNA233062R2200	RC610	137	1SNA233180R2200	RC610	138
1SNA232203R0400	RC65	147	1SNA233063R2300	RC610	137	1SNA233181R1700	RC610	138
1SNA232204R0500	RC65	147	1SNA233064R2400	RC610	137	1SNA233182R1000	RC610	138
1SNA232205R0600	RC65	147	1SNA233065R2500	RC610	137	1SNA233183R1100	RC610	138
1SNA232206R0700	RC65	147	1SNA233066R2600	RC610	137	1SNA233184R1200	RC610	138
1SNA232207R0000	RC65	147	1SNA233067R2700	RC610	137	1SNA233185R1300	RC610	138
1SNA232208R1100	RC65	147	1SNA233068R0000	RC610	137	1SNA233186R1400	RC610	138
1SNA232209R1200	RC65	147	1SNA233069R0100	RC610	137	1SNA233187R1500	RC610	138
1SNA232211R2300	RC65	147	1SNA233074R2600	RC610	135	1SNA233188R2600	RC610	138
1SNA232212R2400	RC65	147	1SNA233075R2700	RC610	135	1SNA233189R2700	RC610	138
1SNA232213R2500	RC65	147	1SNA233076R2000	RC610	135	1SNA233190R2400	RC610	138
1SNA232214R2600	RC65	147	1SNA233080R2100	RC610	137	1SNA233191R1100	RC610	138
1SNA232215R2700	RC65	147	1SNA233081R1600	RC610	137	1SNA233192R1200	RC610	138
1SNA232216R2000	RC65	147	1SNA233082R1700	RC610	137	1SNA233193R1300	RC610	138
1SNA232217R2100	RC65	147	1SNA233083R1000	RC610	137	1SNA233194R1400	RC610	138
1SNA232218R0200	RC65	147	1SNA233084R1100	RC610	137	1SNA233195R1500	RC610	138
1SNA232219R0300	RC65	147	1SNA233085R1200	RC610	137	1SNA233196R1600	RC610	138
1SNA232220R0000	RC65	147	1SNA233086R1300	RC610	137	1SNA233197R1700	RC610	138
1SNA232221R2500	RC65	147	1SNA233087R1400	RC610	137	1SNA233198R2000	RC610	138
1SNA232235R2300	RC65	150	1SNA233088R2500	RC610	137	1SNA233199R2100	RC610	138
1SNA232236R2400	RC65	150	1SNA233090R2300	RC610	134	1SNA233200R1600	RC610	138
1SNA232237R2500	RC65	150	1SNA233091R1000	RC610	134	1SNA233201R0300	RC610	135
1SNA232238R0600	RC65	150	1SNA233092R1100	RC610	134	1SNA233202R0400	RC610	135
1SNA232239R0700	RC65	150	1SNA233093R1200	RC610	134	1SNA233203R0500	RC610	135
1SNA232240R1400	RC65	149	1SNA233094R1300	RC610	134	1SNA233204R0600	RC610	135
1SNA232241R0100	RC65	149	1SNA233095R1400	RC610	134	1SNA233205R0700	RC610	135
1SNA232242R0200	RC65	149	1SNA233096R1500	RC610	134	1SNA233206R0000	RC610	135
1SNA232243R0300	RC65	149	1SNA233097R1600	RC610	134	1SNA233207R0100	RC610	135
1SNA232244R0400	RC65	149	1SNA233098R2700	RC610	134	1SNA233208R1200	RC610	135
1SNA232245R0500	RC65	149	1SNA233099R2000	RC610	134	1SNA233209R1300	RC610	135
1SNA232246R0600	RC65	149	1SNA233100R0200	RC610	134	1SNA233211R2400	RC610	135
1SNA232247R0700	RC65	149	1SNA233101R2700	RC610	134	1SNA233212R2500	RC610	135
1SNA232248R1000	RC65	149	1SNA233102R2000	RC610	134	1SNA233213R2600	RC610	135
1SNA232250R1600	RC65	149	1SNA233103R2100	RC610	134	1SNA233214R2700	RC610	135
1SNA232251R0300	RC65	149	1SNA233104R2200	RC610	134	1SNA233215R2000	RC610	135
1SNA232252R0400	RC65	149	1SNA233105R2300	RC610	134	1SNA233216R2100	RC610	135
1SNA232253R0500	RC65	149	1SNA233106R2400	RC610	134	1SNA233217R2200	RC610	135
1SNA232254R0600	RC65	149	1SNA233107R2500	RC610	134	1SNA233218R0300	RC610	135
1SNA232255R0700	RC65	149	1SNA233108R0600	RC610	134	1SNA233219R0400	RC610	135
1SNA232256R0000	RC65	149	1SNA233109R0700	RC610	134	1SNA233220R0100	RC610	135
1SNA232257R0100	RC65	149	1SNA233110R2300	RC610	134	1SNA233221R2600	RC610	135
1SNA232258R1200	RC65	149	1SNA233111R1000	RC610	136	1SNA233235R2400	RC610	138
1SNA232259R1300	RC65	149	1SNA233112R1100	RC610	136	1SNA233236R2500	RC610	138
1SNA232260R1000	RC65	149	1SNA233113R1200	RC610	136	1SNA233237R2600	RC610	138
1SNA233000R0100	RC610	85	1SNA233114R1300	RC610	136	1SNA233238R0700	RC610	138
1SNA233001R2600	RC610	134	1SNA233115R1400	RC610	136	1SNA233239R0000	RC610	138
1SNA233002R2700	RC610	134	1SNA233116R1500	RC610	136	1SNA233240R1500	RC610	137
1SNA233003R2000	RC610	134	1SNA233117R1600	RC610	136	1SNA233241R0200	RC610	137
1SNA233004R2100	RC610	134	1SNA233118R2700	RC610	136	1SNA233242R0300	RC610	137
1SNA233005R2200	RC610	134	1SNA233119R2000	RC610	136	1SNA233243R0400	RC610	137
1SNA233006R2300	RC610	134	1SNA233120R2500	RC610	134	1SNA233244R0500	RC610	137
1SNA233007R2400	RC610	134	1SNA233124R1500	RC610	138	1SNA233245R0600	RC610	137
1SNA233008R0500	RC610	134	1SNA233125R1600	RC610	138	1SNA233246R0700	RC610	137
1SNA233009R0600	RC610	134	1SNA233126R1700	RC610	138	1SNA233247R0000	RC610	137
1SNA233010R2200	RC610	134	1SNA233127R1000	RC610	138	1SNA233248R1100	RC610	137
1SNA233011R1700	RC610	134	1SNA233131R1400	RC610	136	1SNA233250R1700	RC610	137
1SNA233012R1000	RC610	134	1SNA233132R1500	RC610	136	1SNA233251R0400	RC610	137
1SNA233013R1100	RC610	134	1SNA233133R1600	RC610	135	1SNA233252R0500	RC610	137
1SNA233014R1200	RC610	134	1SNA233134R1700	RC610	135	1SNA233253R0600	RC610	137
1SNA233015R1300	RC610	134	1SNA233135R1000	RC610	135	1SNA233254R0700	RC610	137
1SNA233016R1400	RC610	134	1SNA233136R1100	RC610	135	1SNA233255R0000	RC610	137
1SNA233017R1500	RC610	134	1SNA233137R1200	RC610	135	1SNA233256R0100	RC610	137
1SNA233018R2600	RC610	134	1SNA233141R2600	RC610	135	1SNA233257R0200	RC610	137
1SNA233019R2700	RC610	134	1SNA233142R2700	RC610	135	1SNA233258R1300	RC610	137
1SNA233020R2400	RC610	134	1SNA233143R2000	RC610	138	1SNA233259R1400	RC610	137
1SNA233021R1100	RC610	134	1SNA233144R2100	RC610	138	1SNA233260R1100	RC610	137
1SNA233022R1200	RC610	134	1SNA233145R2200	RC610	138	1SNA233600R1700	RC610TT	17
1SNA233023R1300	RC610	134	1SNA233146R2300	RC610	138	1SNA233700R1300	RC610TT-YL	17
1SNA233024R1400	RC610	134	1SNA233147R2400	RC610	138	1SNA234000R0200	RC810	85
1SNA233025R1500	RC610	134	1SNA233150R0300	RC610	136	1SNA234001R2700	RC810	139
1SNA233026R1600	RC610	134	1SNA233151R2000	RC610	136	1SNA234002R2000	RC810	139
1SNA233027R1700	RC610	134	1SNA233152R2100	RC610	136	1SNA234003R2100	RC810	139
1SNA233028R2000	RC610	134	1SNA233153R2200	RC610	136	1SNA234004R2200	RC810	139
1SNA233029R2100	RC610	134	1SNA233154R2300	RC610	136	1SNA234005R2300	RC810	139
1SNA233030R2600	RC610	135	1SNA233155R2400	RC610	136	1SNA234006R2400	RC810	139
1SNA233031R1300	RC610	135	1SNA233156R2500	RC610	136	1SNA234007R2500	RC810	139
1SNA233032R1400	RC610	135	1SNA233157R2600	RC610	136	1SNA234008R0600	RC810	139

Index

Part Number classification

Part Number	Type	Page	Part Number	Type	Page	Part Number	Type	Page
1SNA234009R0700	RC810	139	1SNA234188R2700	RC810	141	1SNA237007R2000	RCAL85	151
1SNA234010R2300	RC810	139	1SNA234189R2000	RC810	141	1SNA237008R0100	RCAL85	151
1SNA234011R1000	RC810	139	1SNA234190R2500	RC810	141	1SNA237009R0200	RCAL85	151
1SNA234012R1100	RC810	139	1SNA234191R1200	RC810	141	1SNA237010R2600	RCAL85	151
1SNA234013R1200	RC810	139	1SNA234192R1300	RC810	141	1SNA237011R1300	RCAL85	151
1SNA234014R1300	RC810	139	1SNA234193R1400	RC810	141	1SNA237012R1400	RCAL85	151
1SNA234015R1400	RC810	139	1SNA234194R1500	RC810	141	1SNA237013R1500	RCAL85	151
1SNA234016R1500	RC810	139	1SNA234195R1600	RC810	141	1SNA237014R1600	RCAL85	151
1SNA234017R1600	RC810	139	1SNA234196R1700	RC810	141	1SNA237015R1700	RCAL85	151
1SNA234018R2700	RC810	139	1SNA234197R1000	RC810	141	1SNA237016R1000	RCAL85	151
1SNA234019R2000	RC810	139	1SNA234198R2100	RC810	141	1SNA237017R1100	RCAL85	151
1SNA234020R2500	RC810	139	1SNA234199R2200	RC810	141	1SNA237018R2200	RCAL85	151
1SNA234021R1200	RC810	139	1SNA234200R1700	RC810	141	1SNA237019R2300	RCAL85	151
1SNA234030R2700	RC810	139	1SNA234201R0400	RC810	141	1SNA237020R2000	RCAL85	151
1SNA234031R1400	RC810	139	1SNA234202R0500	RC810	141	1SNA237021R1500	RCAL85	151
1SNA234032R1500	RC810	139	1SNA234203R0600	RC810	141	1SNA237030R2200	RCAL85	151
1SNA234033R1600	RC810	139	1SNA234204R0700	RC810	141	1SNA237031R1700	RCAL85	151
1SNA234034R1700	RC810	139	1SNA234205R0000	RC810	141	1SNA237032R1000	RCAL85	151
1SNA234035R1000	RC810	139	1SNA234600R1000	RC810TT	17	1SNA237033R1100	RCAL85	151
1SNA234036R1100	RC810	139	1SNA234700R1400	RC810TT-YL	17	1SNA237034R1200	RCAL85	151
1SNA234037R1200	RC810	139	1SNA235093R1400	WMTT12	26	1SNA237035R1300	RCAL85	151
1SNA234038R2300	RC810	139	1SNA235094R1500	WMTT18	26	1SNA237036R1400	RCAL85	151
1SNA234039R2400	RC810	139	1SNA235095R1600	PCP510	18	1SNA237040R0400	RCAL85	152
1SNA234040R0100	RC810	141	1SNA235096R1700	RCW510	18	1SNA237041R2100	RCAL85	152
1SNA234041R2600	RC810	141	1SNA235097R1000	RCL510	18	1SNA237042R2200	RCAL85	152
1SNA234042R2700	RC810	141	1SNA235103R2300	PAM21515	32	1SNA237043R2300	RCAL85	152
1SNA234043R2000	RC810	141	1SNA235104R2400	PAM43015	32	1SNA237044R2400	RCAL85	152
1SNA234044R2100	RC810	141	1SNA235105R2500	PAM21520	32	1SNA237045R2500	RCAL85	152
1SNA234045R2200	RC810	141	1SNA235106R2600	PAM43020	32	1SNA237046R2600	RCAL85	152
1SNA234046R2300	RC810	141	1SNA235109R0100	PPS5015	105	1SNA237047R2700	RCAL85	152
1SNA234047R2400	RC810	141	1SNA235111R1200	PPB2715	34	1SNA237048R0000	RCAL85	152
1SNA234048R0500	RC810	141	1SNA235114R1500	PAT10060	36	1SNA237049R0100	RCAL85	152
1SNA234049R0600	RC810	141	1SNA235115R1600	PPT12030	36	1SNA237050R0600	RCAL85	152
1SNA234050R0300	RC810	141	1SNA235116R1700	PPT18050	36	1SNA237051R2300	RCAL85	152
1SNA234051R2000	RC810	141	1SNA235117R1000	RING122	27	1SNA237060R0000	RCAL85	152
1SNA234052R2100	RC810	141	1SNA235118R2100	RING124	27	1SNA237061R2500	RCAL85	152
1SNA234053R2200	RC810	141	1SNA235119R2200	RING127	27	1SNA237062R2600	RCAL85	152
1SNA234054R2300	RC810	141	1SNA235120R2700	RING1210	27	1SNA237063R2700	RCAL85	152
1SNA234055R2400	RC810	141	1SNA235123R1600	RING182	27	1SNA237064R2000	RCAL85	152
1SNA234056R2500	RC810	141	1SNA235124R1700	RING184	27	1SNA237065R2100	RCAL85	152
1SNA234057R2600	RC810	141	1SNA235125R1000	RING187	27	1SNA237066R2200	RCAL85	152
1SNA234058R0700	RC810	141	1SNA235126R1100	RING1810	27	1SNA237067R2300	RCAL85	152
1SNA234059R0000	RC810	141	1SNA235129R2400	SNAP152	27	1SNA237068R0400	RCAL85	152
1SNA234060R0500	RC810	141	1SNA235130R2100	SNAP154	27	1SNA237074R2200	RCAL85	151
1SNA234061R2200	RC810	141	1SNA235131R1600	SNAP157	27	1SNA237075R2300	RCAL85	151
1SNA234062R2300	RC810	141	1SNA235132R1700	SNAP1510	27	1SNA237076R2400	RCAL85	151
1SNA234063R2400	RC810	141	1SNA235133R1000	SNAP232	27	1SNA237080R2500	RCAL85	152
1SNA234064R2500	RC810	141	1SNA235134R1100	SNAP234	27	1SNA237081R1200	RCAL85	152
1SNA234065R2600	RC810	141	1SNA235135R1200	SNAP237	27	1SNA237082R1300	RCAL85	152
1SNA234066R2700	RC810	141	1SNA235136R1300	SNAP2310	27	1SNA237083R1400	RCAL85	152
1SNA234067R2000	RC810	141	1SNA235137R1400	RINGT23	27	1SNA237084R1500	RCAL85	152
1SNA234068R0100	RC810	141	1SNA235142R2100	RINGT209	28	1SNA237085R1600	RCAL85	152
1SNA234069R0200	RC810	141	1SNA235146R2500	PAM100015	35	1SNA237086R1700	RCAL85	152
1SNA234072R2500	RC810	141	1SNA235147R2600	PCT100015	35	1SNA237087R1000	RCAL85	152
1SNA234111R1100	RC810	140	1SNA235148R0700	VM12	100	1SNA237088R2100	RCAL85	152
1SNA234112R1200	RC810	140	1SNA235149R0000	VM18	100	1SNA237131R1000	RCAL85	151
1SNA234113R1300	RC810	140	1SNA235150R0500	PCGS209	28	1SNA237132R1100	RCAL85	151
1SNA234114R1400	RC810	140	1SNA235151R2200	RPA-TT	30	1SNA238000R1600	RC1010	85
1SNA234115R1500	RC810	140	1SNA235152R2300	RPA-TT-YL	30	1SNA238001R0300	RC1010	142
1SNA234116R1600	RC810	140	1SNA235155R2600	PIB2-TT	30	1SNA238002R0400	RC1010	142
1SNA234130R2000	RC810	139	1SNA235156R2700	BA4	33	1SNA238003R0500	RC1010	142
1SNA234150R0400	RC810	140	1SNA235157R2000	PIB2-TT-YL	30	1SNA238004R0600	RC1010	142
1SNA234151R2100	RC810	140	1SNA235158R0100	RCPEAD-TT	22	1SNA238005R0700	RC1010	142
1SNA234152R2200	RC810	140	1SNA235159R0200	RCPEAD-TT-YL	22	1SNA238006R0000	RC1010	142
1SNA234153R2300	RC810	140	1SNA235159R0400	RCVV	103	1SNA238007R0100	RC1010	142
1SNA234154R2400	RC810	140	1SNA235461R2100	PIB2	104	1SNA238008R1200	RC1010	142
1SNA234155R2500	RC810	140	1SNA235462R2200	PIB3	96	1SNA238009R1300	RC1010	142
1SNA234156R2600	RC810	140	1SNA235463R2300	RPA	104	1SNA238010R0700	RC1010	142
1SNA234157R2700	RC810	140	1SNA235700R1500	HTP500-V2 KIT	12	1SNA238011R2400	RC1010	142
1SNA234158R0000	RC810	140	1SNA235702R0300	HTS500	12	1SNA238012R2500	RC1010	142
1SNA234159R0100	RC810	140	1SNA235703R0400	HTP500-FEED	12	1SNA238013R2600	RC1010	142
1SNA234160R0600	RC810	140	1SNA235704R0500	HTP500-PL	12	1SNA238014R2700	RC1010	142
1SNA234161R2300	RC810	140	1SNA235705R0600	HTP500-PL2	12	1SNA238015R2000	RC1010	142
1SNA234162R2400	RC810	140	1SNA235706R0700	HTP500-BAS	12	1SNA238016R2100	RC1010	142
1SNA234163R2500	RC810	140	1SNA235707R0000	HTP500-PL3	12	1SNA238017R2200	RC1010	142
1SNA234164R2600	RC810	140	1SNA235709R1200	HTP500-PW	12	1SNA238018R0300	RC1010	142
1SNA234165R2700	RC810	140	1SNA235710R0600	RIB-B	12	1SNA238019R0400	RC1010	142
1SNA234166R2000	RC810	140	1SNA235711R2300	RIB-R	12	1SNA238020R0100	RC1010	142
1SNA234167R2100	RC810	140	1SNA235712R2400	HTP500-BA4	12	1SNA238021R2600	RC1010	142
1SNA234168R0200	RC810	140	1SNA235714R2600	HTP500-CLEAN	12	1SNA238022R2700	RC1010	142
1SNA234169R0300	RC810	140	1SNA235715R2700	HTP500-ROLL	12	1SNA238023R2000	RC1010	142
1SNA234170R0000	RC810	140	1SNA235716R2000	HTP500-PRINT	12	1SNA238024R2100	RC1010	142
1SNA234171R2500	RC810	140	1SNA235717R2100	HTP500-WB	12	1SNA238025R2200	RC1010	142
1SNA234172R2600	RC810	140	1SNA235718R0200	RIB-RS	12	1SNA238026R2300	RC1010	142
1SNA234173R2700	RC810	140	1SNA236000R0400	RCT610	87	1SNA238030R0300	RC1010	142
1SNA234174R2000	RC810	140	1SNA236001R2100	RCT610	153	1SNA238031R2000	RC1010	142
1SNA234175R2100	RC810	140	1SNA236000R0600	RCT810	87	1SNA238032R2100	RC1010	142
1SNA234180R2300	RC810	141	1SNA236501R2300	RCT810	153	1SNA238033R2200	RC1010	142
1SNA234181R1000	RC810	141	1SNA237000R0500	RCAL85	86	1SNA238034R2300	RC1010	142
1SNA234182R1100	RC810	141	1SNA237001R2200	RCAL85	151	1SNA238035R2400	RC1010	142
1SNA234183R1200	RC810	141	1SNA237002R2300	RCAL85	151	1SNA238036R2500	RC1010	142
1SNA234184R1300	RC810	141	1SNA237003R2400	RCAL85	151	1SNA238037R2600	RC1010	142
1SNA234185R1400	RC810	141	1SNA237004R2500	RCAL85	151	1SNA238038R0700	RC1010	142
1SNA234186R1500	RC810	141	1SNA237005R2600	RCAL85	151	1SNA238039R0000	RC1010	142
1SNA234187R1600	RC810	141	1SNA237006R2700	RCAL85	151	1SNA238040R1500	RC1010	142



Index

Part Number classification

Part Number	Type	Page	Part Number	Type	Page	Part Number	Type	Page
1SNA238041R0200	RC1010	142	1SNB040341R0416	MG2-TDMO-01 40341	57	1SNB050100R0000	PM-01 50100	61
1SNA238050R1700	RC1010	143	1SNB040390R0412	MG2-TDMO-01 40390	57	1SNB050102R0001	PM-01 50102	61
1SNA238051R0400	RC1010	143	1SNB040391R0416	MG2-TDMO-01 40391	57	1SNB050110R0000	PM-01 50110	61
1SNA238052R0500	RC1010	143	1SNB040440R0412	MG2-TDMO-02 40440	57	1SNB050112R0000	PM-01 50112	61
1SNA238053R0600	RC1010	143	1SNB040441R0416	MG2-TDMO-02 40441	57	1SNB050120R0000	PM-01 50120	61
1SNA238054R0700	RC1010	143	1SNB040490R0412	MG2-TDMO-02 40490	57	1SNB050122R0000	PM-01 50122	61
1SNA238055R0000	RC1010	143	1SNB040491R0416	MG2-TDMO-02 40491	57	1SNB050200R0000	PM-02 50200	61
1SNA238056R0100	RC1010	143	1SNB040540R0412	MG2-TDMO-03 40540	57	1SNB050202R0000	PM-02 50202	61
1SNA238057R0200	RC1010	143	1SNB040541R0416	MG2-TDMO-03 40541	57	1SNB050210R0000	PM-02 50210	61
1SNA238058R1300	RC1010	143	1SNB040590R0412	MG2-TDMO-03 40590	57	1SNB050212R0000	PM-02 50212	61
1SNA238059R1400	RC1010	143	1SNB040591R0416	MG2-TDMO-03 40591	57	1SNB050220R0000	PM-02 50220	61
1SNA238060R1100	RC1010	143	1SNB041090R0510	MG-CPM-01 41090	48	1SNB050222R0000	PM-02 50222	61
1SNA238061R0600	RC1010	143	1SNB041091R0515	MG-CPM-01 41091	48	1SNB050300R0000	PM-03 50300	61
1SNA238062R0700	RC1010	143	1SNB041094R0507	MG-CPM-01 41094	46	1SNB050302R0000	PM-03 50302	61
1SNA238063R0000	RC1010	143	1SNB041140R0510	MG-CPM-02 41140	48	1SNB050310R0000	PM-03 50310	61
1SNA238064R0100	RC1010	143	1SNB041190R0510	MG-CPM-02 41190	48	1SNB050312R0000	PM-03 50312	61
1SNA238065R0200	RC1010	143	1SNB041291R0510	MG-CPM-03 41291	46	1SNB050320R0000	PM-03 50320	61
1SNA238066R0300	RC1010	143	1SNB041293R0510	MG-CPM-03 41293	48	1SNB050322R0000	PM-03 50322	61
1SNA238067R0400	RC1010	143	1SNB041340R0510	MG-CPM-04 41340	46	1SNB050400R0000	PM-04 50400	61
1SNA238068R1500	RC1010	143	1SNB041390R0510	MG-CPM-04 41390	46	1SNB050402R0000	PM-04 50402	61
1SNA238069R1600	RC1010	143	1SNB041391R0610	MG-CPM-04 41391	46	1SNB050410R0000	PM-04 50410	61
1SNA238070R1300	RC1010	143	1SNB041395R0510	MG-CPM-04 41395	48	1SNB050411R0000	PM-04 50411	61
1SNA238071R0000	RC1010	143	1SNB041490R0510	MG-CPM-05 41490	46	1SNB050420R0000	PM-04 50420	61
1SNA238072R0100	RC1010	143	1SNB041494R0510	MG-CPM-05 41494	48	1SNB050421R0000	PM-04 50421	61
1SNA238073R0200	RC1010	143	1SNB041591R0510	MG-CPM-06 41591	48	1SNB050500R0000	PM-05 50500	61
1SNA238074R0300	RC1010	143	1SNB041691R0510	MG-CPM-07 41691	49	1SNB050510R0000	PM-05 50510	61
1SNA238075R0400	RC1010	143	1SNB041740R0512	MG-CPM-13 41740	46	1SNB050521R0000	PM-05 50521	61
1SNA238080R0600	RC1010	143	1SNB041741R0612	MG-CPM-13 41741	46	1SNB050600R0000	PM-06 50600	61
1SNA238081R2300	RC1010	143	1SNB041790R0512	MG-CPM-13 41790	46	1SNB050610R0000	PM-06 50610	61
1SNA238082R2400	RC1010	143	1SNB041791R0612	MG-CPM-13 41791	46	1SNB050620R0000	PM-06 50620	61
1SNA238083R2500	RC1010	143	1SNB041890R0510	MG-CPM-09 41890	49	1SNB051000R0000	PM-AC 51000N	61
1SNA238084R2600	RC1010	143	1SNB042090R0410	MG-TPMF 42090B	62	1SNB051010R0000	PM-AC 51010N	61
1SNA238085R2700	RC1010	143	1SNB042091R0412	MG-TPMF 42091B	62	1SNB051020R0000	PM-AC 51020N	61
1SNA238086R2000	RC1010	143	1SNB042092R0415	MG-TPMF 42092B	62	1SNB053010R0000	PM-ET 53010	61
1SNA238087R2100	RC1010	143	1SNB043090R0010	MG-CPMF 43090	47	1SNB053020R0000	PM-ET 53020	61
1SNA238088R0200	RC1010	143	1SNB043091R0076	MG-CPMF 43091	47	1SNB054142R1357	MG-ETF 54142	59
1SNA290455R0700	RB-12W7	88	1SNB043094R0052	MG-CPMF 43094	47	1SNB054192R1357	MG-ETF 54192	59
1SNA360000R2400	KIT MAO AMS 600	80	1SNB043146R0012	MG-CPMFA 43146	47	1SNB063020R0000	PMF-ET 63020	63
1SNA360000R2500	AMS 250 BASIC KIT	80	1SNB043196R0012	MG-CPMFA 43196	47	1SNB066000R0000	PMF-AC 66000N	63
1SNA360010R1500	SPRC 1	81	1SNB044845R0915	MG-VYT 44845	65	1SNB066010R0000	PMF-AC 66010N	63
1SNA360011R0200	SPRCC 2	103	1SNB044895R0915	MG-VYT 44895	65	1SNB066020R0000	PMF-AC 66020N	63
1SNA360011R1500	SPRC 2	81	1SNB044896R0920	MG-VYT 44896N	65	1SNB066040R0000	PMF-AC 66040N	63
1SNA360014R0500	SPRC 4	81	1SNB045194R1735	MG-TAR 45194	72	1SNB071000R0017	MG-PLC 71000	73
1SNA360015R0600	SPRC 5	81	1SNB045195R1744	MG-TAR 45195	72	1SNB071001R0022	MG-PLC 71001	73
1SNA360016R0700	SPRC 6	81	1SNB046192R0512	MG-CPM-10 46192	49	1SNB071002R0012	MG-PLC 71002	73
1SNA360017R0000	SPRC 7	81	1SNB046390R4209	MG-CPM-12 46390	46	1SNB071040R0017	MG-PLC 71040	73
1SNA360018R1100	SPRC 8	81	1SNB046391R4206	MG-CPM-12 46391	49	1SNB071041R0022	MG-PLC 71041	73
1SNA360019R1200	SPRC 9	81	1SNB046415R0615	MG-VYT 46415	65	1SNB071042R0012	MG-PLC 71042	73
1SNA360020R1700	SPRC 10	81	1SNB046423R0817	MG-VYT 46423	65	1SNB071044R0025	MG-PLC 71044	73
1SNA360021R0400	SPRC 11	81	1SNB046811R0052	MG-VYT 46811	65	1SNB071050R0017	MG-PLC 71050	73
1SNA360023R0600	SPRC 13	81	1SNB046815R0615	MG-VYT 46815	65	1SNB071051R0022	MG-PLC 71051	73
1SNA360024R0700	SPRC 14	81	1SNB046823R0817	MG-VYT 46823	65	1SNB071052R0012	MG-PLC 71052	73
1SNA360025R0000	SPRC 15	81	1SNB046824R0821	MG-VYT 46824	65	1SNB071090R0017	MG-PLC 71090	73
1SNA360026R0100	SPRC 16	81	1SNB046828R0715	MG-VYT 46828	65	1SNB071091R0022	MG-PLC 71091	73
1SNA360031R0600	SPRC 21	81	1SNB046891R0710	MG-VYT 46891	65	1SNB071092R0012	MG-PLC 71092	73
1SNA360036R0300	SPRC 26	81	1SNB046896R0920	MG-VYT 46896N	65	1SNB071094R0025	MG-PLC 71094	73
1SNA360037R0400	SPRC 27	81	1SNB046910R0935	MG-VYT 46910N	65	1SNB088903R0052	MG-VRT-A 88903	74
1SNA360038R1500	SPRC 29	81	1SNB046915R0615	MG-VYT 46915	65	1SNB090000R0000	PMF-00 90000	63
1SNA360039R1700	SPRC 30-3	81	1SNB046923R0817	MG-VYT 46923	65	1SNB090010R0000	PMF-00 90010	63
1SNA360040R2300	SPRC 28	81	1SNB046927R0512	MG-VYT 46927	65	1SNB090020R0000	PMF-00 90020	63
1SNA360098R1200	PEN HOLDER	81	1SNB046935R0720	MG-VYT 46935	65	1SNB090100R0000	PMF-01 90100	63
1SNA360100R2500	AMS PEN 0.25	81	1SNB046990R0100	MG-CPMFA 46990	47	1SNB090110R0000	PMF-01 90110	63
1SNA360101R1200	AMS PEN 0.35	81	1SNB047041R1527	MG-TAP 47041N	68	1SNB090120R0000	PMF-01 90120	63
1SNA360103R1400	AMS PEN 0.18	81	1SNB047047R1827	MG-TAP 47047	68	1SNB090200R0000	PMF-02 90200	63
1SNA360104R1500	AMS PEN 0.50	81	1SNB047091R1527	MG-TAP 47091N	68	1SNB090210R0000	PMF-02 90210	63
1SNA360105R1600	AMS PEN 0.70	81	1SNB047092R1549	MG-TAP 47092N	68	1SNB090220R0000	PMF-02 90220	63
1SNA360106R1700	AMS PEN 1.00	81	1SNB047093R1567	MG-TAP 47093N	68	1SNB090300R0000	PMF-03 90300	63
1SNA360120R1000	DISPOSABLE AMS PEN 0.25	81	1SNB047096R0827	MG-TAP 47096	68	1SNB090310R0000	PMF-03 90310	63
1SNA360121R0500	DISPOSABLE AMS PEN 0.35	81	1SNB047097R1827	MG-TAP 47097	68	1SNB090320R0000	PMF-03 90320	63
1SNA360122R1000	DISPOSABLE AMS PEN ED-R 0.25	81	1SNB047198R1543	MG-TAP 47198	68	1SNB090400R0000	PMF-04 90400	63
1SNA360123R0500	DISPOSABLE AMS PEN ED-R 0.35	81	1SNB048903R0052	MG-VRT-R 48903	74	1SNB090410R0000	PMF-04 90410	63
1SNA360124R1000	DISPOSABLE AMS PEN ED-R 0.18	81	1SNB049040R0920	MG-TAPW 49040N	70	1SNB090420R0000	PMF-04 90420	63
1SNA360150R2600	AMS INK CARTRIDGES	81	1SNB049042R0912	MG-TAPW 49042N	70	1SNB090500R0000	PMF-05 90500	63
1SNA360155R1700	AMS CLEANER FLUID	81	1SNB049043R0915	MG-TAPW 49043N	70	1SNB090510R0000	PMF-05 90510	63
1SNA360156R1000	AMS CLEANER KIT	81	1SNB049046R0929	MG-TAPW 49046	70	1SNB090520R0000	PMF-05 90520	63
1SNA360161R1500	DUST COVER	12	1SNB049090R0920	MG-TAPW 49090N	70	1SNB419001R0000	MG3 KIT	43
1SNA360162R1600	SERVICE KIT FOR AMS 600	81	1SNB049091R0935	MG-TAPW 49091N	70	1SNB990452R0000	RTR-TAP 990452	69
1SNA360163R1700	SPDST1	81	1SNB049093R0915	MG-TAPW 49093N	70	1SNB990453R0000	RTA-TAP 990453N	69
1SNA399719R1000	PEAD	22	1SNB049096R0929	MG-TAPW 49096	70	1SNB990454R0000	RTR-TAP 990454	69
1SNA399725R0600	RCPEAD	94	1SNB049143R1527	MG-TAA 49143N	64	1SNB990455R0000	RTA-TAP 990455N	69
1SNA399726R0700	EPR2	22	1SNB049144R1549	MG-TAA 49144N	64	1SNB990456R0000	RT-CCP 990456	69
1SNA400252R1200	VSP22	157	1SNB049145R1567	MG-TAA 49145N	64	1SNB990513R1549	MG-TAP-CCS 990513	71
1SNB015090R4030	MG-PTS 15090	67	1SNB049148R1735	MG-TAA 49148	64	1SNB990514R1567	MG-TAP-CCS 990514	71
1SNB040090R0410	MG-TPM 40090	60	1SNB049190N0920	MG-TAA 49190N	64	1SNB990653R0000	RTA-TAPW 990653N	70
1SNB040091R0412	MG-TPM 40091	60	1SNB049191R0935	MG-TAA 49191N	64	1SNB990824R0015	MG-17.5-A 990824	66
1SNB040092R0415	MG-TPM 40092	60	1SNB049193R1527	MG-TAA 49193N	64	1SNB990826R0015	MG-17.5-A 990826	66
1SNB040140R0412	MG-TDM-01 40140	56	1SNB049194R1549	MG-TAA 49194N	64	1SNB991000R0000	MG2-PWC 991000	43
1SNB040141R0416	MG-TDM-01 40141	56	1SNB049195R1567	MG-TAA 49195N	64	1SNB991002R0000	MG2-PLT 991002	43
1SNB040190R0412	MG-TDM-01 40190	56	1SNB049196R0720	MG-TAA 49196	64	1SNB991004R0000	MG2-WTB 991004	43
1SNB040191R0416	MG-TDM-01 40191	56	1SNB049198R1735	MG-TAA 49198	64	1SNB991005R0000	MG2-STB 991005	43
1SNB040240R0412	MG-TDM-02 40240	56	1SNB049298R1544	MG-TAA 49298	64	1SNB991006R0000	MG2-CTB 991006	43
1SNB040241R0416	MG-TDM-02 40241	56	1SNB049397R0915	MG-TAA 49397N	64	1SNB991007R0000	MG2-PTD 991007	43
1SNB040290R0412	MG-TDM-02 40290	56	1SNB049448R8530	MG-TAA 49448	64	1SNB991008R0000	MG2-MTB 991008	43
1SNB040291R0416	MG-TDM-02 40291	56	1SNB049493R0817	MG-TAA 49493	64	1SNB991010R0000	MG2-PTM 991010	43
1SNB040340R0412	MG2-TDMO-01 40340	57	1SNB049498R8530	MG-TAA 49498	64	1SNB991011R0000	MG2-QTB 991011	43

Index

Type classification

Type	Part Number	Page	Type	Part Number	Page	Type	Part Number	Page
AMS 250 BASIC KIT	1SNA360000R2500	80	MC512PA	1SNK145042R0000	116	MC512PA	1SNK148052R0000	117
AMS CLEANER FLUID	1SNA360155R1700	81	MC512PA	1SNK145051R0000	114	MC512PA	1SNK148061R0000	115
AMS CLEANER KIT	1SNA360156R1000	81	MC512PA	1SNK145052R0000	116	MC512PA	1SNK148062R0000	117
AMS INK CARTRIDGES	1SNA360150R2600	81	MC512PA	1SNK145061R0000	114	MC512PA	1SNK148071R0000	115
AMS PEN 0.18	1SNA360103R1400	81	MC512PA	1SNK145062R0000	116	MC512PA	1SNK148072R0000	117
AMS PEN 0.25	1SNA360100R2500	81	MC512PA	1SNK145071R0000	114	MC512PA	1SNK148091R0000	115
AMS PEN 0.35	1SNA360101R1200	81	MC512PA	1SNK145072R0000	116	MC512PA	1SNK148092R0000	117
AMS PEN 0.50	1SNA360104R1500	81	MC512PA	1SNK145081R0000	114	MC512PA	1SNK148101R0000	115
AMS PEN 0.70	1SNA360105R1600	81	MC512PA	1SNK145082R0000	116	MC512PA	1SNK148102R0000	117
AMS PEN 1.00	1SNA360106R1700	81	MC512PA	1SNK145091R0000	114	MC512PA	1SNK148111R0000	115
BA4	1SNA235156R2700	33	MC512PA	1SNK145092R0000	116	MC512PA	1SNK148112R0000	117
DISPOSABLE AMS PEN 0.25	1SNA360120R1000	81	MC512PA	1SNK145102R0000	116	MC512PA	1SNK148121R0000	115
DISPOSABLE AMS PEN 0.35	1SNA360121R0500	81	MC512PA	1SNK146011R0000	115	MC512PA	1SNK148122R0000	117
DISPOSABLE AMS PEN ED-R 0.18	1SNA360124R1000	81	MC512PA	1SNK146012R0000	116	MC512PA	1SNK148131R0000	115
DISPOSABLE AMS PEN ED-R 0.25	1SNA360122R1000	81	MC512PA	1SNK146021R0000	115	MC512PA	1SNK148132R0000	117
DISPOSABLE AMS PEN ED-R 0.35	1SNA360123R0500	81	MC512PA	1SNK146022R0000	116	MC512PA	1SNK148141R0000	115
DUST COVER	1SNA360161R1500	12	MC512PA	1SNK146031R0000	115	MC512PA	1SNK148142R0000	117
EP10	1SNA163429R2100	157	MC512PA	1SNK146032R0000	116	MC512PA	1SNK148151R0000	115
EP12	1SNA163430R2600	157	MC512PA	1SNK146041R0000	115	MC512PA	1SNK148152R0000	117
EP16	1SNA163431R1300	157	MC512PA	1SNK146042R0000	116	MC512PA	1SNK148161R0000	115
EP223	1SNA173327R2400	157	MC512PA	1SNK146051R0000	115	MC512PA	1SNK148162R0000	117
EP224	1SNA173328R0500	157	MC512PA	1SNK146052R0000	116	MC512PA	1SNK148171R0000	115
EP6	1SNA163427R1700	157	MC512PA	1SNK146061R0000	115	MC512PA	1SNK148172R0000	117
EP8	1SNA163428R2000	157	MC512PA	1SNK146062R0000	116	MC512PA	1SNK148181R0000	115
EPR1	1SNA178431R2200	31	MC512PA	1SNK146071R0000	115	MC512PA	1SNK148182R0000	117
EPR2	1SNA399726R0700	22	MC512PA	1SNK146072R0000	116	MC512PA	1SNK148192R0000	117
EPU5	1SNA107033R1000	156	MC512PA	1SNK146081R0000	115	MC512PA	1SNK148202R0000	117
EPU6	1SNA107038R2500	156	MC512PA	1SNK146082R0000	116	MC512PA	1SNK148212R0000	117
HTP500-BA4	1SNA235712R2400	12	MC512PA	1SNK146091R0000	115	MC512PA	1SNK148222R0000	117
HTP500-BAS	1SNA235706R0700	12	MC512PA	1SNK146092R0000	116	MC512PA	1SNK149001R0000	115
HTP500-CLEAN	1SNA235714R2600	12	MC512PA	1SNK146101R0000	115	MC512PA	1SNK149002R0000	117
HTP500-FEED	1SNA235703R0400	12	MC512PA	1SNK146102R0000	116	MC512PA	1SNK149011R0000	115
HTP500-PL	1SNA235704R0500	12	MC512PA	1SNK146111R0000	115	MC512PA	1SNK149012R0000	117
HTP500-PL2	1SNA235705R0600	12	MC512PA	1SNK146121R0000	117	MC512PA	1SNK149999R0000	84
HTP500-PL3	1SNA235707R0000	12	MC512PA	1SNK146122R0000	115	MC512-YL	1SNK140004R0000	16
HTP500-PRINT	1SNA235716R2000	12	MC512PA	1SNK146123R0000	117	MC612	1SNK150000R0000	16
HTP500-PW	1SNA235709R1200	12	MC512PA	1SNK146131R0000	115	MC612PA	1SNK150011R0000	118
HTP500-ROLL	1SNA235715R2700	12	MC512PA	1SNK146132R0000	117	MC612PA	1SNK150012R0000	120
HTP500-V2 KIT	1SNA235700R1500	12	MC512PA	1SNK146141R0000	115	MC612PA	1SNK150021R0000	118
HTP500-WB	1SNA235717R2100	12	MC512PA	1SNK146142R0000	117	MC612PA	1SNK150022R0000	120
HTS500	1SNA235702R0300	12	MC512PA	1SNK146151R0000	115	MC612PA	1SNK150031R0000	118
KA1-8120	1SFA616920R8120	35	MC512PA	1SNK146152R0000	117	MC612PA	1SNK150032R0000	120
KIT MAO AMS 500	1SNA360000R2400	80	MC512PA	1SNK146161R0000	115	MC612PA	1SNK150041R0000	118
LH	1SNK900605R0000	21	MC512PA	1SNK146162R0000	117	MC612PA	1SNK150042R0000	120
LH-R1	1SNK900607R0000	21	MC512PA	1SNK146171R0000	115	MC612PA	1SNK150051R0000	118
MC512	1SNK140000R0000	16	MC512PA	1SNK146172R0000	117	MC612PA	1SNK150052R0000	120
MC512PA	1SNK140011R0000	114	MC512PA	1SNK146181R0000	115	MC612PA	1SNK150061R0000	118
MC512PA	1SNK140012R0000	116	MC512PA	1SNK146182R0000	117	MC612PA	1SNK150062R0000	120
MC512PA	1SNK140021R0000	114	MC512PA	1SNK146191R0000	115	MC612PA	1SNK150071R0000	118
MC512PA	1SNK140022R0000	116	MC512PA	1SNK146192R0000	117	MC612PA	1SNK150072R0000	120
MC512PA	1SNK140031R0000	114	MC512PA	1SNK146201R0000	115	MC612PA	1SNK150081R0000	118
MC512PA	1SNK140032R0000	116	MC512PA	1SNK146202R0000	117	MC612PA	1SNK150082R0000	120
MC512PA	1SNK140041R0000	114	MC512PA	1SNK146211R0000	115	MC612PA	1SNK150083R0000	118
MC512PA	1SNK140042R0000	116	MC512PA	1SNK146212R0000	117	MC612PA	1SNK150084R0000	120
MC512PA	1SNK140051R0000	114	MC512PA	1SNK146221R0000	115	MC612PA	1SNK150091R0000	118
MC512PA	1SNK140052R0000	116	MC512PA	1SNK146222R0000	117	MC612PA	1SNK150092R0000	120
MC512PA	1SNK140061R0000	114	MC512PA	1SNK146231R0000	115	MC612PA	1SNK150101R0000	118
MC512PA	1SNK140062R0000	116	MC512PA	1SNK146232R0000	117	MC612PA	1SNK150102R0000	120
MC512PA	1SNK140071R0000	114	MC512PA	1SNK146241R0000	115	MC612PA	1SNK150111R0000	118
MC512PA	1SNK140072R0000	116	MC512PA	1SNK146242R0000	117	MC612PA	1SNK150112R0000	120
MC512PA	1SNK140081R0000	114	MC512PA	1SNK146251R0000	115	MC612PA	1SNK150121R0000	118
MC512PA	1SNK140082R0000	116	MC512PA	1SNK146252R0000	117	MC612PA	1SNK150122R0000	120
MC512PA	1SNK140083R0000	114	MC512PA	1SNK146261R0000	115	MC612PA	1SNK150131R0000	118
MC512PA	1SNK140084R0000	116	MC512PA	1SNK146262R0000	117	MC612PA	1SNK150132R0000	120
MC512PA	1SNK140091R0000	114	MC512PA	1SNK147001R0000	114	MC612PA	1SNK150141R0000	118
MC512PA	1SNK140092R0000	116	MC512PA	1SNK147002R0000	116	MC612PA	1SNK150142R0000	120
MC512PA	1SNK140101R0000	114	MC512PA	1SNK147011R0000	114	MC612PA	1SNK150151R0000	118
MC512PA	1SNK140102R0000	116	MC512PA	1SNK147012R0000	116	MC612PA	1SNK150152R0000	120
MC512PA	1SNK140111R0000	114	MC512PA	1SNK147021R0000	114	MC612PA	1SNK150161R0000	118
MC512PA	1SNK140112R0000	116	MC512PA	1SNK147022R0000	116	MC612PA	1SNK150162R0000	120
MC512PA	1SNK140121R0000	114	MC512PA	1SNK147031R0000	114	MC612PA	1SNK150171R0000	118
MC512PA	1SNK140122R0000	116	MC512PA	1SNK147032R0000	116	MC612PA	1SNK150172R0000	120
MC512PA	1SNK140131R0000	114	MC512PA	1SNK147041R0000	114	MC612PA	1SNK150181R0000	118
MC512PA	1SNK140132R0000	116	MC512PA	1SNK147042R0000	116	MC612PA	1SNK150182R0000	120
MC512PA	1SNK140141R0000	114	MC512PA	1SNK147051R0000	114	MC612PA	1SNK150191R0000	118
MC512PA	1SNK140142R0000	116	MC512PA	1SNK147052R0000	116	MC612PA	1SNK150192R0000	120
MC512PA	1SNK140151R0000	114	MC512PA	1SNK147061R0000	114	MC612PA	1SNK150201R0000	118
MC512PA	1SNK140152R0000	116	MC512PA	1SNK147062R0000	116	MC612PA	1SNK150202R0000	120
MC512PA	1SNK140161R0000	114	MC512PA	1SNK147071R0000	114	MC612PA	1SNK155011R0000	118
MC512PA	1SNK140162R0000	116	MC512PA	1SNK147072R0000	116	MC612PA	1SNK155012R0000	120
MC512PA	1SNK140171R0000	114	MC512PA	1SNK147081R0000	114	MC612PA	1SNK155021R0000	118
MC512PA	1SNK140172R0000	116	MC512PA	1SNK147082R0000	116	MC612PA	1SNK155022R0000	120
MC512PA	1SNK140181R0000	114	MC512PA	1SNK147091R0000	114	MC612PA	1SNK155031R0000	118
MC512PA	1SNK140182R0000	116	MC512PA	1SNK147092R0000	116	MC612PA	1SNK155032R0000	120
MC512PA	1SNK140191R0000	114	MC512PA	1SNK148001R0000	115	MC612PA	1SNK155041R0000	118
MC512PA	1SNK140192R0000	116	MC512PA	1SNK148002R0000	117	MC612PA	1SNK155042R0000	120
MC512PA	1SNK140201R0000	114	MC512PA	1SNK148011R0000	115	MC612PA	1SNK155051R0000	118
MC512PA	1SNK140202R0000	116	MC512PA	1SNK148012R0000	117	MC612PA	1SNK155052R0000	120
MC512PA	1SNK145011R0000	114	MC512PA	1SNK148021R0000	115	MC612PA	1SNK155061R0000	118
MC512PA	1SNK145012R0000	116	MC512PA	1SNK148022R0000	117	MC612PA	1SNK155062R0000	120
MC512PA	1SNK145021R0000	114	MC512PA	1SNK148031R0000	115	MC612PA	1SNK155071R0000	118
MC512PA	1SNK145022R0000	116	MC512PA	1SNK148032R0000	117	MC612PA	1SNK155072R0000	120
MC512PA	1SNK145031R0000	114	MC512PA	1SNK148041R0000	115	MC612PA	1SNK155081R0000	118
MC512PA	1SNK145032R0000	116	MC512PA	1SNK148042R0000	117	MC612PA	1SNK155082R0000	120
MC512PA	1SNK145041R0000	114	MC512PA	1SNK148051R0000	115	MC612PA	1SNK155091R0000	118

Type classification

Type	Part Number	Page	Type	Part Number	Page	Type	Part Number	Page
MC812PA	1SNK168162R0000	125	MG-PLC 71040	1SNB071040R0017	73	PETC 53	1SNA168741R1600	103
MC812PA	1SNK168171R0000	123	MG-PLC 71041	1SNB071041R0022	73	PETC 56	1SNA168747R1400	103
MC812PA	1SNK168172R0000	125	MG-PLC 71042	1SNB071042R0012	73	PEV	1SNA113180R1200	89
MC812PA	1SNK168181R0000	123	MG-PLC 71044	1SNB071044R0025	73	PIB	1SNA173812R1300	96
MC812PA	1SNK168182R0000	125	MG-PLC 71050	1SNB071050R0017	73	PIB2	1SNA235461R2100	104
MC812PA	1SNK168192R0000	125	MG-PLC 71051	1SNB071051R0022	73	PIB2-TT	1SNA235155R2600	30
MC812PA	1SNK168202R0000	125	MG-PLC 71052	1SNB071052R0012	73	PIB2-TT-YL	1SNA235157R2000	30
MC812PA	1SNK168212R0000	125	MG-PLC 71090	1SNB071090R0017	73	PIB3	1SNA235462R2200	96
MC812PA	1SNK168222R0000	125	MG-PLC 71091	1SNB071091R0022	73	PM-01 50100	1SNB050100R0000	61
MC812PA	1SNK169001R0000	123	MG-PLC 71092	1SNB071092R0012	73	PM-01 50102	1SNB050102R0001	61
MC812PA	1SNK169002R0000	125	MG-PLC 71094	1SNB071094R0025	73	PM-01 50102-HF	1SNB050102R0002	61
MC812PA	1SNK169011R0000	123	MG-PTS 15090	1SNB015090R4030	67	PM-01 50110	1SNB050110R0000	61
MC812PA	1SNK169012R0000	125	MG-TAA 49143N	1SNB049143R1527	64	PM-01 50120	1SNB050120R0000	61
MC812PA	1SNK169999R0000	84	MG-TAA 49144N	1SNB049144R1549	64	PM-01 50122	1SNB050122R0000	61
MC812-YL	1SNK160004R0000	16	MG-TAA 49145N	1SNB049145R1567	64	PM-02 50200	1SNB050200R0000	61
MCLH	1SNK900630R0000	20	MG-TAA 49148	1SNB049148R1735	64	PM-02 50202	1SNB050202R0000	61
MCLH-R1	1SNK900631R0000	20	MG-TAA 49190N	1SNB049190N0920	64	PM-02 50210	1SNB050210R0000	61
MCLH-R1-YL	1SNK900634R0000	20	MG-TAA 49191N	1SNB049191R0935	64	PM-02 50212	1SNB050212R0000	61
MCLH-YL	1SNK900633R0000	20	MG-TAA 49193N	1SNB049193R1527	64	PM-02 50220	1SNB050220R0000	61
MG-17.5-A 990824	1SNB990824R0015	66	MG-TAA 49194N	1SNB049194R1549	64	PM-02 50222	1SNB050222R0000	61
MG-17.5-A 990826	1SNB990826R0015	66	MG-TAA 49195N	1SNB049195R1567	64	PM-03 50300	1SNB050300R0000	61
MG2-ABM 991012	1SNB991012R0000	43	MG-TAA 49196	1SNB049196R0720	64	PM-03 50302	1SNB050302R0000	61
MG2-CKP 991670	1SNB991670R0000	43	MG-TAA 49198	1SNB049198R1735	64	PM-03 50310	1SNB050310R0000	61
MG2-CTB 991006	1SNB991006R0000	43	MG-TAA 49298	1SNB049298R1544	64	PM-03 50312	1SNB050312R0000	61
MG2-ETB 991016	1SNB991016R0000	43	MG-TAA 49397N	1SNB049397R0915	64	PM-03 50320	1SNB050320R0000	61
MG2-ETR 991600	1SNB991600R0000	43	MG-TAA 49448	1SNB049448R8530	64	PM-03 50322	1SNB050322R0000	61
MG2-ETR 991601	1SNB991601R0000	43	MG-TAA 49493	1SNB049493R0817	64	PM-04 50400	1SNB050400R0000	61
MG2-ETR 991602	1SNB991602R0000	43	MG-TAA 49498	1SNB049498R8530	64	PM-04 50402	1SNB050402R0000	61
MG2-ETR 991603	1SNB991603R0000	43	MG-TAP 47041N	1SNB047041R1527	68	PM-04 50410	1SNB050410R0000	61
MG2-ETR 991606	1SNB991606R0000	43	MG-TAP 47047	1SNB047047R1827	68	PM-04 50411	1SNB050411R0000	61
MG2-LTB 991013	1SNB991013R0000	43	MG-TAP 47091N	1SNB047091R1527	68	PM-04 50420	1SNB050420R0000	61
MG2-MTB 991008	1SNB991008R0000	43	MG-TAP 47092N	1SNB047092R1549	68	PM-04 50421	1SNB050421R0000	61
MG2-PLT 991002	1SNB991002R0000	43	MG-TAP 47093N	1SNB047093R1567	68	PM-05 50500	1SNB050500R0000	61
MG2-PTD 991007	1SNB991007R0000	43	MG-TAP 47096	1SNB047096R0827	68	PM-05 50510	1SNB050510R0000	61
MG2-PTM 991010	1SNB991010R0000	43	MG-TAP 47097	1SNB047097R1827	68	PM-05 50521	1SNB050521R0000	61
MG2-PWC 991000	1SNB991000R0000	43	MG-TAP 47198	1SNB047198R1543	68	PM-06 50600	1SNB050600R0000	61
MG2-QTB 991011	1SNB991011R0000	43	MG-TAP-CCS 990513	1SNB990513R1549	71	PM-06 50610	1SNB050610R0000	61
MG2-STB 991005	1SNB991005R0000	43	MG-TAP-CCS 990514	1SNB990514R1567	71	PM-06 50620	1SNB050620R0000	61
MG2-TCT 991562	1SNB991562R0000	43	MG-TAPW 49040N	1SNB049040R0920	70	PM-AC 51000N	1SNB051000R0000	61
MG2-TDMO-01 40340	1SNB040340R0412	57	MG-TAPW 49042N	1SNB049042R0912	70	PM-AC 51010N	1SNB051010R0000	61
MG2-TDMO-01 40341	1SNB040341R0416	57	MG-TAPW 49043N	1SNB049043R0915	70	PM-AC 51020N	1SNB051020R0000	61
MG2-TDMO-01 40390	1SNB040390R0412	57	MG-TAPW 49046	1SNB049046R0929	70	PM-ET 53010	1SNB053010R0000	61
MG2-TDMO-01 40391	1SNB040391R0416	57	MG-TAPW 49090N	1SNB049090R0920	70	PM-ET 53020	1SNB053020R0000	61
MG2-TDMO-02 40440	1SNB040440R0412	57	MG-TAPW 49091N	1SNB049091R0935	70	PMF-00 90000	1SNB090000R0000	63
MG2-TDMO-02 40441	1SNB040441R0416	57	MG-TAPW 49093N	1SNB049093R0915	70	PMF-00 90010	1SNB090010R0000	63
MG2-TDMO-02 40490	1SNB040490R0412	57	MG-TAPW 49096	1SNB049096R0929	70	PMF-00 90020	1SNB090020R0000	63
MG2-TDMO-02 40491	1SNB040491R0416	57	MG-TAR 45194	1SNB045194R1735	72	PMF-01 90100	1SNB090100R0000	63
MG2-TDMO-03 40540	1SNB040540R0412	57	MG-TAR 45195	1SNB045195R1744	72	PMF-01 90110	1SNB090110R0000	63
MG2-TDMO-03 40541	1SNB040541R0416	57	MG-TDM-01 40140	1SNB040140R0412	56	PMF-01 90120	1SNB090120R0000	63
MG2-TDMO-03 40590	1SNB040590R0412	57	MG-TDM-01 40141	1SNB040141R0416	56	PMF-02 90200	1SNB090200R0000	63
MG2-TDMO-03 40591	1SNB040591R0416	57	MG-TDM-01 40190	1SNB040190R0412	56	PMF-02 90210	1SNB090210R0000	63
MG2-TGT 991532	1SNB991532R0000	43	MG-TDM-01 40191	1SNB040191R0416	56	PMF-02 90220	1SNB090220R0000	63
MG2-TLT 991522	1SNB991522R0000	43	MG-TDM-02 40240	1SNB040240R0412	56	PMF-03 90300	1SNB090300R0000	63
MG2-TMT 991513	1SNB991513R0000	43	MG-TDM-02 40241	1SNB040241R0416	56	PMF-03 90310	1SNB090310R0000	63
MG2-TST 991552	1SNB991552R0000	43	MG-TDM-02 40290	1SNB040290R0412	56	PMF-03 90320	1SNB090320R0000	63
MG2-TTB 991512	1SNB991512R0000	43	MG-TDM-02 40291	1SNB040291R0416	56	PMF-04 90400	1SNB090400R0000	63
MG2-TTD 991563	1SNB991563R0000	43	MG-TPM 40090	1SNB040090R0410	60	PMF-04 90410	1SNB090410R0000	63
MG2-TWC 991502	1SNB991502R0000	43	MG-TPM 40091	1SNB040091R0412	60	PMF-04 90420	1SNB090420R0000	63
MG2-TWT 991542	1SNB991542R0000	43	MG-TPM 40092	1SNB040092R0415	60	PMF-05 90500	1SNB090500R0000	63
MG2-WTB 991004	1SNB991004R0000	43	MG-TPMF 42090B	1SNB042090R0410	62	PMF-05 90510	1SNB090510R0000	63
MG3 KIT	1SNB419001R0000	43	MG-TPMF 42091B	1SNB042091R0412	62	PMF-05 90520	1SNB090520R0000	63
MG-CPM-01 41090	1SNB041090R0510	48	MG-TPMF 42092B	1SNB042092R0415	62	PMF-AC 66000N	1SNB066000R0000	63
MG-CPM-01 41091	1SNB041091R0515	48	MG-VRT-A 88903	1SNB088903R0052	74	PMF-AC 66010N	1SNB066010R0000	63
MG-CPM-01 41094	1SNB041094R0507	46	MG-VRT-R 48903	1SNB048903R0052	74	PMF-AC 66020N	1SNB066020R0000	63
MG-CPM-02 41140	1SNB041140R0510	48	MG-VYT 44845	1SNB044845R0915	65	PMF-AC 66040N	1SNB066040R0000	63
MG-CPM-02 41190	1SNB041190R0510	48	MG-VYT 44895	1SNB044895R0915	65	PMF-ET 63020	1SNB063020R0000	63
MG-CPM-03 41291	1SNB041291R0510	46	MG-VYT 44896N	1SNB044896R0920	65	PPB2715	1SNA235111R1200	34
MG-CPM-03 41293	1SNB041293R0510	48	MG-VYT 46415	1SNB046415R0615	65	PPT12030	1SNA235115R1600	36
MG-CPM-04 41340	1SNB041340R0510	46	MG-VYT 46423	1SNB046423R0817	65	PPT18050	1SNA235116R1700	36
MG-CPM-04 41390	1SNB041390R0510	46	MG-VYT 46811	1SNB046811R0052	65	PSP5015	1SNA235109R0100	105
MG-CPM-04 41391	1SNB041391R0610	46	MG-VYT 46815	1SNB046815R0615	65	RB-12W7	1SNA290455R0700	88
MG-CPM-04 41395	1SNB041395R0510	48	MG-VYT 46823	1SNB046823R0817	65	RC1010	1SNA238000R1600	85
MG-CPM-05 41490	1SNB041490R0510	46	MG-VYT 46824	1SNB046824R0821	65	RC1010	1SNA238001R0300	142
MG-CPM-05 41494	1SNB041494R0510	48	MG-VYT 46828	1SNB046828R0715	65	RC1010	1SNA238002R0400	142
MG-CPM-06 41591	1SNB041591R0510	48	MG-VYT 46891	1SNB046891R0710	65	RC1010	1SNA238003R0500	142
MG-CPM-07 41691	1SNB041691R0510	49	MG-VYT 46896N	1SNB046896R0920	65	RC1010	1SNA238004R0600	142
MG-CPM-09 41890	1SNB041890R0510	49	MG-VYT 46910N	1SNB046910R0935	65	RC1010	1SNA238005R0700	142
MG-CPM-10 46192	1SNB046192R0512	49	MG-VYT 46915	1SNB046915R0615	65	RC1010	1SNA238006R0000	142
MG-CPM-12 46390	1SNB046390R4209	46	MG-VYT 46923	1SNB046923R0817	65	RC1010	1SNA238007R0100	142
MG-CPM-12 46391	1SNB046391R4206	49	MG-VYT 46927	1SNB046927R0512	65	RC1010	1SNA238008R1200	142
MG-CPM-13 41740	1SNB041740R0512	46	MG-VYT 46935	1SNB046935R0720	65	RC1010	1SNA238009R1300	142
MG-CPM-13 41741	1SNB041741R0612	46	PAM100015	1SNA235146R2500	35	RC1010	1SNA238010R0700	142
MG-CPM-13 41790	1SNB041790R0512	46	PAM21515	1SNA235103R2300	32	RC1010	1SNA238011R2400	142
MG-CPM-13 41791	1SNB041791R0612	46	PAM21520	1SNA235105R2500	32	RC1010	1SNA238012R2500	142
MG-CPMF 43090	1SNB043090R0010	47	PAM43015	1SNA235104R2400	32	RC1010	1SNA238013R2600	142
MG-CPMF 43091	1SNB043091R0076	47	PAM43020	1SNA235106R2600	32	RC1010	1SNA238014R2700	142
MG-CPMF 43094	1SNB043094R0052	47	PAT10060	1SNA235114R1500	36	RC1010	1SNA238015R2000	142
MG-CPMFA 43146	1SNB043146R0012	47	PCGS209	1SNA235150R0500	28	RC1010	1SNA238016R2100	142
MG-CPMFA 43196	1SNB043196R0012	47	PCT100015	1SNA235147R2600	35	RC1010	1SNA238017R2200	142
MG-CPMFA 46990	1SNB046990R0010	47	PEAD	1SNA399719R1000	22	RC1010	1SNA238018R0300	142
MG-ETF 54142	1SNB054142R1357	59	PEB	1SNA113077R1100	31	RC1010	1SNA238019R0400	142
MG-ETF 54192	1SNB054192R1357	59	PEBM	1SNA113084R1000	31	RC1010	1SNA238020R0100	142
MG-PLC 71000	1SNB071000R0017	73	PEH	1SNA163211R2600	95	RC1010	1SNA238021R2600	142
MG-PLC 71001	1SNB071001R0022	73	PEN HOLDER	1SNA360098R1200	81	RC1010	1SNA238022R2700	142
MG-PLC 71002	1SNB071002R0012	73	PETC 51	1SNA168737R0200	103	RC1010	1SNA238023R2000	142



Index

Type classification

Type	Part Number	Page	Type	Part Number	Page	Type	Part Number	Page
RC1010	1SNA238024R2100	142	RC410	1SNA229112R2500	127	RC510	1SNA231019R2500	130
RC1010	1SNA238025R2200	142	RC410	1SNA229113R2600	127	RC510	1SNA231020R2200	130
RC1010	1SNA238026R2300	142	RC410	1SNA229114R2700	127	RC510	1SNA231021R1700	130
RC1010	1SNA238030R0300	142	RC410	1SNA229115R2000	127	RC510	1SNA231030R2400	130
RC1010	1SNA238031R2000	142	RC410	1SNA229150R1700	127	RC510	1SNA231031R1100	130
RC1010	1SNA238032R2100	142	RC410	1SNA229151R0400	127	RC510	1SNA231032R1200	130
RC1010	1SNA238033R2200	142	RC410	1SNA229152R0500	127	RC510	1SNA231033R1300	130
RC1010	1SNA238034R2300	142	RC410	1SNA229153R0600	127	RC510	1SNA231034R1400	130
RC1010	1SNA238035R2400	142	RC410	1SNA229154R0700	127	RC510	1SNA231035R1500	130
RC1010	1SNA238036R2500	142	RC410	1SNA229155R0000	127	RC510	1SNA231036R1600	130
RC1010	1SNA238037R2600	142	RC410	1SNA229156R0100	127	RC510	1SNA231037R1700	130
RC1010	1SNA238038R0700	142	RC410	1SNA229157R0200	127	RC510	1SNA231038R2000	130
RC1010	1SNA238039R0000	142	RC410	1SNA229158R1300	127	RC510	1SNA231039R2100	130
RC1010	1SNA238040R1500	142	RC410	1SNA229159R1400	127	RC510	1SNA231040R0600	132
RC1010	1SNA238041R0200	142	RC410	1SNA229160R1100	127	RC510	1SNA231041R2300	132
RC1010	1SNA238050R1700	143	RC410	1SNA229161R0600	127	RC510	1SNA231042R2400	132
RC1010	1SNA238051R0400	143	RC410	1SNA229162R0700	127	RC510	1SNA231043R2500	132
RC1010	1SNA238052R0500	143	RC410	1SNA229163R0000	127	RC510	1SNA231044R2600	132
RC1010	1SNA238053R0600	143	RC410	1SNA229164R0100	127	RC510	1SNA231045R2700	132
RC1010	1SNA238054R0700	143	RC410	1SNA229165R0200	127	RC510	1SNA231046R2000	132
RC1010	1SNA238055R0000	143	RC410	1SNA229166R0300	127	RC510	1SNA231047R2100	132
RC1010	1SNA238056R0100	143	RC410	1SNA229167R0400	127	RC510	1SNA231048R0200	132
RC1010	1SNA238057R0200	143	RC410	1SNA229168R1500	127	RC510	1SNA231049R0300	132
RC1010	1SNA238058R1300	143	RC410	1SNA229169R1600	127	RC510	1SNA231050R0000	132
RC1010	1SNA238059R1400	143	RC410	1SNA229170R1300	127	RC510	1SNA231051R2500	132
RC1010	1SNA238060R1100	143	RC410	1SNA229171R0000	127	RC510	1SNA231052R2600	132
RC1010	1SNA238061R0600	143	RC410	1SNA229172R0100	127	RC510	1SNA231053R2700	132
RC1010	1SNA238062R0700	143	RC410	1SNA229173R0200	127	RC510	1SNA231054R2000	132
RC1010	1SNA238063R0000	143	RC410	1SNA229174R0300	127	RC510	1SNA231055R2100	132
RC1010	1SNA238064R0100	143	RC410	1SNA229175R0400	127	RC510	1SNA231056R2200	132
RC1010	1SNA238065R0200	143	RC410	1SNA229180R0600	129	RC510	1SNA231057R2300	132
RC1010	1SNA238066R0300	143	RC410	1SNA229181R2300	129	RC510	1SNA231058R0400	132
RC1010	1SNA238067R0400	143	RC410	1SNA229182R2400	129	RC510	1SNA231059R0500	132
RC1010	1SNA238068R1500	143	RC410	1SNA229183R2500	129	RC510	1SNA231060R0200	132
RC1010	1SNA238069R1600	143	RC410	1SNA229184R2600	129	RC510	1SNA231061R2700	132
RC1010	1SNA238070R1300	143	RC410	1SNA229185R2700	129	RC510	1SNA231062R2000	132
RC1010	1SNA238071R0000	143	RC410	1SNA229186R2000	129	RC510	1SNA231063R2100	132
RC1010	1SNA238072R0100	143	RC410	1SNA229187R2100	129	RC510	1SNA231064R2200	132
RC1010	1SNA238073R0200	143	RC410	1SNA229188R0200	129	RC510	1SNA231065R2300	132
RC1010	1SNA238074R0300	143	RC410	1SNA229189R0300	129	RC510	1SNA231066R2400	132
RC1010	1SNA238075R0400	143	RC410	1SNA229190R0000	129	RC510	1SNA231067R2500	132
RC1010	1SNA238080R0600	143	RC410	1SNA229191R2500	129	RC510	1SNA231068R0600	132
RC1010	1SNA238081R2300	143	RC410	1SNA229192R2600	129	RC510	1SNA231069R0700	132
RC1010	1SNA238082R2400	143	RC410	1SNA229193R2700	129	RC510	1SNA231072R2200	132
RC1010	1SNA238083R2500	143	RC410	1SNA229194R2000	129	RC510	1SNA231111R1600	131
RC1010	1SNA238084R2600	143	RC410	1SNA229195R2100	129	RC510	1SNA231112R1700	131
RC1010	1SNA238085R2700	143	RC410	1SNA229196R2200	129	RC510	1SNA231113R1000	131
RC1010	1SNA238086R2000	143	RC410	1SNA229197R2300	129	RC510	1SNA231114R1100	131
RC1010	1SNA238087R2100	143	RC410	1SNA229198R0400	129	RC510	1SNA231115R1200	131
RC1010	1SNA238088R0200	143	RC410	1SNA229199R0500	129	RC510	1SNA231116R1300	131
RC410	1SNA229000R1500	85	RC410	1SNA229200R2200	129	RC510	1SNA231117R1400	131
RC410	1SNA229001R0200	126	RC410	1SNA229201R1700	129	RC510	1SNA231118R2500	131
RC410	1SNA229002R0300	126	RC410	1SNA229202R1000	129	RC510	1SNA231119R2600	131
RC410	1SNA229003R0400	126	RC410	1SNA229203R1100	129	RC510	1SNA231131R1200	131
RC410	1SNA229004R0500	126	RC410	1SNA229204R1200	129	RC510	1SNA231133R1400	132
RC410	1SNA229005R0600	126	RC410	1SNA229205R1300	129	RC510	1SNA231134R1500	132
RC410	1SNA229006R0700	126	RC410	1SNA229210R1300	126	RC510	1SNA231135R1600	132
RC410	1SNA229007R0000	126	RC410	1SNA229211R0000	126	RC510	1SNA231136R1700	132
RC410	1SNA229008R1100	126	RC410	1SNA229212R0100	126	RC510	1SNA231137R1000	132
RC410	1SNA229009R1200	126	RC410	1SNA229213R0200	126	RC510	1SNA231150R0100	131
RC410	1SNA229010R0600	126	RC410	1SNA229214R0300	126	RC510	1SNA231151R2600	131
RC410	1SNA229011R2300	126	RC410	1SNA229215R0400	126	RC510	1SNA231152R2700	131
RC410	1SNA229030R0200	126	RC410	1SNA229216R0500	126	RC510	1SNA231153R2000	131
RC410	1SNA229040R1400	128	RC410	1SNA229217R0600	126	RC510	1SNA231154R2100	131
RC410	1SNA229041R0100	128	RC410	1SNA229218R1700	126	RC510	1SNA231155R2200	131
RC410	1SNA229042R0200	128	RC410	1SNA229220R1500	126	RC510	1SNA231156R2300	131
RC410	1SNA229043R0300	128	RC410	1SNA229221R0200	126	RC510	1SNA231157R2400	131
RC410	1SNA229044R0400	128	RC410	1SNA229222R0300	126	RC510	1SNA231158R0500	131
RC410	1SNA229045R0500	128	RC410	1SNA229223R0400	126	RC510	1SNA231159R0600	131
RC410	1SNA229046R0600	128	RC410	1SNA229224R0500	126	RC510	1SNA231160R0300	131
RC410	1SNA229047R0700	128	RC410	1SNA229225R0600	126	RC510	1SNA231161R2000	131
RC410	1SNA229048R1000	128	RC410	1SNA229226R0700	126	RC510	1SNA231162R2100	131
RC410	1SNA229049R1100	128	RC410	1SNA229227R0000	126	RC510	1SNA231163R2200	131
RC410	1SNA229050R1600	128	RC410	1SNA229228R1100	126	RC510	1SNA231164R2300	131
RC410	1SNA229051R0300	128	RC410	1SNA229229R1200	126	RC510	1SNA231165R2400	131
RC410	1SNA229052R0400	128	RC410	1SNA229230R1700	126	RC510	1SNA231166R2500	131
RC410	1SNA229053R0500	128	RC510	1SNA231000R0700	85	RC510	1SNA231167R2600	131
RC410	1SNA229054R0600	128	RC510	1SNA231001R2400	130	RC510	1SNA231168R0700	131
RC410	1SNA229055R0700	128	RC510	1SNA231002R2500	130	RC510	1SNA231169R0000	131
RC410	1SNA229056R0000	128	RC510	1SNA231003R2600	130	RC510	1SNA231170R0500	131
RC410	1SNA229057R0100	128	RC510	1SNA231004R2700	130	RC510	1SNA231171R2200	131
RC410	1SNA229058R1200	128	RC510	1SNA231005R2000	130	RC510	1SNA231172R2300	131
RC410	1SNA229059R1300	128	RC510	1SNA231006R2100	130	RC510	1SNA231173R2400	131
RC410	1SNA229060R1000	128	RC510	1SNA231007R2200	130	RC510	1SNA231174R2500	131
RC410	1SNA229061R0500	128	RC510	1SNA231008R0300	130	RC510	1SNA231175R2600	131
RC410	1SNA229062R0600	128	RC510	1SNA231009R0400	130	RC510	1SNA231180R2000	133
RC410	1SNA229063R0700	128	RC510	1SNA231010R2000	130	RC510	1SNA231181R1500	133
RC410	1SNA229064R0000	128	RC510	1SNA231011R1500	130	RC510	1SNA231182R1600	133
RC410	1SNA229065R0100	128	RC510	1SNA231012R1600	130	RC510	1SNA231183R1700	133
RC410	1SNA229066R0200	128	RC510	1SNA231013R1700	130	RC510	1SNA231184R1000	133
RC410	1SNA229067R0300	128	RC510	1SNA231014R1000	130	RC510	1SNA231185R1100	133
RC410	1SNA229068R1400	128	RC510	1SNA231015R1100	130	RC510	1SNA231186R1200	133
RC410	1SNA229069R1500	128	RC510	1SNA231016R1200	130	RC510	1SNA231187R1300	133
RC410	1SNA229072R0000	128	RC510	1SNA231017R1300	130	RC510	1SNA231188R2400	133
RC410	1SNA229111R2400	127	RC510	1SNA231018R2400	130	RC510	1SNA231189R2500	133

Index

Type classification

Type	Part Number	Page	Type	Part Number	Page	Type	Part Number	Page
RC510	1SNA231190R2200	133	RC55	1SNA230064R0500	146	RC610	1SNA233000R0100	85
RC510	1SNA231191R1700	133	RC55	1SNA230065R0600	146	RC610	1SNA233001R2600	134
RC510	1SNA231192R1000	133	RC55	1SNA230066R0700	146	RC610	1SNA233002R2700	134
RC510	1SNA231193R1100	133	RC55	1SNA230067R0000	146	RC610	1SNA233003R2000	134
RC510	1SNA231194R1200	133	RC55	1SNA230068R1100	146	RC610	1SNA233004R2100	134
RC510	1SNA231195R1300	133	RC55	1SNA230069R1200	146	RC610	1SNA233005R2200	134
RC510	1SNA231196R1400	133	RC55	1SNA230072R0500	146	RC610	1SNA233006R2300	134
RC510	1SNA231197R1500	133	RC55	1SNA230111R2100	145	RC610	1SNA233007R2400	134
RC510	1SNA231198R2600	133	RC55	1SNA230112R2200	145	RC610	1SNA233008R0500	134
RC510	1SNA231199R2700	133	RC55	1SNA230113R2300	145	RC610	1SNA233009R0600	134
RC510	1SNA231200R1400	133	RC55	1SNA230114R2400	145	RC610	1SNA233010R2200	134
RC510	1SNA231201R0100	133	RC55	1SNA230115R2500	145	RC610	1SNA233011R1700	134
RC510	1SNA231202R0200	133	RC55	1SNA230116R2600	145	RC610	1SNA233012R1000	134
RC510	1SNA231203R0300	133	RC55	1SNA230117R2700	145	RC610	1SNA233013R1100	134
RC510	1SNA231204R0400	133	RC55	1SNA230118R0000	145	RC610	1SNA233014R1200	134
RC510	1SNA231205R0500	133	RC55	1SNA230119R0100	145	RC610	1SNA233015R1300	134
RC510	1SNA231210R0500	130	RC55	1SNA230131R2500	145	RC610	1SNA233016R1400	134
RC510	1SNA231211R2200	130	RC55	1SNA230150R1400	145	RC610	1SNA233017R1500	134
RC510	1SNA231212R2300	130	RC55	1SNA230151R0100	145	RC610	1SNA233018R2600	134
RC510	1SNA231213R2400	130	RC55	1SNA230152R0200	145	RC610	1SNA233019R2700	134
RC510	1SNA231214R2500	130	RC55	1SNA230153R0300	145	RC610	1SNA233020R2400	134
RC510	1SNA231215R2600	130	RC55	1SNA230154R0400	145	RC610	1SNA233021R1100	134
RC510	1SNA231216R2700	130	RC55	1SNA230155R0500	145	RC610	1SNA233022R1200	134
RC510	1SNA231217R2000	130	RC55	1SNA230156R0600	145	RC610	1SNA233023R1300	134
RC510	1SNA231218R0100	130	RC55	1SNA230157R0700	145	RC610	1SNA233024R1400	134
RC510	1SNA231220R0700	130	RC55	1SNA230158R1000	145	RC610	1SNA233025R1500	134
RC510	1SNA231221R2400	130	RC55	1SNA230159R1100	145	RC610	1SNA233026R1600	134
RC510	1SNA231222R2500	130	RC55	1SNA230160R1600	145	RC610	1SNA233027R1700	134
RC510	1SNA231223R2600	130	RC55	1SNA230161R0300	145	RC610	1SNA233028R2000	134
RC510	1SNA231224R2700	130	RC55	1SNA230162R0400	145	RC610	1SNA233029R2100	134
RC510	1SNA231225R2000	130	RC55	1SNA230163R0500	145	RC610	1SNA233030R2600	135
RC510	1SNA231226R2100	130	RC55	1SNA230164R0600	145	RC610	1SNA233031R1300	135
RC510	1SNA231227R2200	130	RC55	1SNA230165R0700	145	RC610	1SNA233032R1400	135
RC510	1SNA231228R0300	130	RC55	1SNA230166R0000	145	RC610	1SNA233033R1500	135
RC510	1SNA231229R0400	130	RC55	1SNA230167R0100	145	RC610	1SNA233034R1600	135
RC510	1SNA231230R0100	130	RC55	1SNA230168R1200	145	RC610	1SNA233035R1700	135
RC510TT	1SNA231600R1500	17	RC55	1SNA230169R1300	145	RC610	1SNA233036R1000	135
RC510TT-YL	1SNA231700R1100	17	RC55	1SNA230170R1000	145	RC610	1SNA233040R0000	137
RC510-YL	1SNA103890R2100	85	RC55	1SNA230171R0500	145	RC610	1SNA233041R2500	137
RC55	1SNA230000R1200	86	RC55	1SNA230172R0600	145	RC610	1SNA233042R2600	137
RC55	1SNA230001R0700	144	RC55	1SNA230173R0700	145	RC610	1SNA233043R2700	137
RC55	1SNA230002R0000	144	RC55	1SNA230174R0000	145	RC610	1SNA233044R2000	137
RC55	1SNA230003R0100	144	RC55	1SNA230175R0100	145	RC610	1SNA233045R2100	137
RC55	1SNA230004R0200	144	RC55	1SNA230180R0300	146	RC610	1SNA233046R2200	137
RC55	1SNA230005R0300	144	RC55	1SNA230181R2000	146	RC610	1SNA233047R2300	137
RC55	1SNA230006R0400	144	RC55	1SNA230182R2100	146	RC610	1SNA233048R0400	137
RC55	1SNA230007R0500	144	RC55	1SNA230183R2200	146	RC610	1SNA233049R0500	137
RC55	1SNA230008R1600	144	RC55	1SNA230184R2300	146	RC610	1SNA233050R0200	137
RC55	1SNA230009R1700	144	RC55	1SNA230185R2400	146	RC610	1SNA233051R2700	137
RC55	1SNA230010R0300	144	RC55	1SNA230186R2500	146	RC610	1SNA233060R0400	137
RC55	1SNA230011R2000	144	RC55	1SNA230187R2600	146	RC610	1SNA233061R2100	137
RC55	1SNA230012R2100	144	RC55	1SNA230188R0700	146	RC610	1SNA233062R2200	137
RC55	1SNA230013R2200	144	RC55	1SNA230189R0000	146	RC610	1SNA233063R2300	137
RC55	1SNA230014R2300	144	RC55	1SNA230190R0500	146	RC610	1SNA233064R2400	137
RC55	1SNA230015R2400	144	RC55	1SNA230191R2200	146	RC610	1SNA233065R2500	137
RC55	1SNA230016R2500	144	RC55	1SNA230192R2300	146	RC610	1SNA233066R2600	137
RC55	1SNA230017R2600	144	RC55	1SNA230193R2400	146	RC610	1SNA233067R2700	137
RC55	1SNA230018R0700	144	RC55	1SNA230194R2500	146	RC610	1SNA233068R0000	137
RC55	1SNA230019R0000	144	RC55	1SNA230195R2600	146	RC610	1SNA233069R0100	137
RC55	1SNA230020R0500	144	RC55	1SNA230196R2700	146	RC610	1SNA233074R2600	135
RC55	1SNA230021R2200	144	RC55	1SNA230197R2000	146	RC610	1SNA233075R2700	135
RC55	1SNA230030R0700	144	RC55	1SNA230198R0100	146	RC610	1SNA233076R2000	135
RC55	1SNA230031R2400	144	RC55	1SNA230199R0200	146	RC610	1SNA233080R2100	137
RC55	1SNA230032R2500	144	RC55	1SNA230200R2700	146	RC610	1SNA233081R1600	137
RC55	1SNA230033R2600	144	RC55	1SNA230201R1400	146	RC610	1SNA233082R1700	137
RC55	1SNA230034R2700	144	RC55	1SNA230202R1500	146	RC610	1SNA233083R1000	137
RC55	1SNA230035R2000	144	RC55	1SNA230203R1600	146	RC610	1SNA233084R1100	137
RC55	1SNA230036R2100	144	RC55	1SNA230204R1700	146	RC610	1SNA233085R1200	137
RC55	1SNA230037R2200	144	RC55	1SNA230205R1000	146	RC610	1SNA233086R1300	137
RC55	1SNA230038R0300	144	RC55	1SNA230240R2600	144	RC610	1SNA233087R1400	137
RC55	1SNA230039R0400	144	RC55	1SNA230241R1300	144	RC610	1SNA233088R2500	137
RC55	1SNA230040R1100	146	RC55	1SNA230242R1400	144	RC610	1SNA233090R2300	134
RC55	1SNA230041R0600	146	RC55	1SNA230243R1500	144	RC610	1SNA233091R1000	134
RC55	1SNA230042R0700	146	RC55	1SNA230244R1600	144	RC610	1SNA233092R1100	134
RC55	1SNA230043R0000	146	RC55	1SNA230245R1700	144	RC610	1SNA233093R1200	134
RC55	1SNA230044R0100	146	RC55	1SNA230246R1000	144	RC610	1SNA233094R1300	134
RC55	1SNA230045R0200	146	RC55	1SNA230247R1100	144	RC610	1SNA233095R1400	134
RC55	1SNA230046R0300	146	RC55	1SNA230248R2200	144	RC610	1SNA233096R1500	134
RC55	1SNA230047R0400	146	RC55	1SNA230250R2000	144	RC610	1SNA233097R1600	134
RC55	1SNA230048R1500	146	RC55	1SNA230251R1500	144	RC610	1SNA233098R2700	134
RC55	1SNA230049R1600	146	RC55	1SNA230252R1600	144	RC610	1SNA233099R2000	134
RC55	1SNA230050R1300	146	RC55	1SNA230253R1700	144	RC610	1SNA233100R0200	134
RC55	1SNA230051R0000	146	RC55	1SNA230254R1000	144	RC610	1SNA233101R2700	134
RC55	1SNA230052R0100	146	RC55	1SNA230255R1100	144	RC610	1SNA233102R2000	134
RC55	1SNA230053R0200	146	RC55	1SNA230256R1200	144	RC610	1SNA233103R2100	134
RC55	1SNA230054R0300	146	RC55	1SNA230257R1300	144	RC610	1SNA233104R2200	134
RC55	1SNA230055R0400	146	RC55	1SNA230258R2400	144	RC610	1SNA233105R2300	134
RC55	1SNA230056R0500	146	RC55	1SNA230259R2500	144	RC610	1SNA233106R2400	134
RC55	1SNA230057R0600	146	RC55	1SNA230260R2200	144	RC610	1SNA233107R2500	134
RC55	1SNA230058R1700	146	RC610	1SNA206230R1100	85	RC610	1SNA233108R0600	134
RC55	1SNA230059R1000	146	RC610	1SNA206231R0600	85	RC610	1SNA233109R0700	134
RC55	1SNA230060R1500	146	RC610	1SNA206232R0700	85	RC610	1SNA233110R2300	134
RC55	1SNA230061R0200	146	RC610	1SNA206233R0000	85	RC610	1SNA233111R1000	136
RC55	1SNA230062R0300	146	RC610	1SNA206234R0100	85	RC610	1SNA233112R1100	136
RC55	1SNA230063R0400	146	RC610	1SNA206235R0200	85	RC610	1SNA233113R1200	136



Index

Type classification

Type	Part Number	Page	Type	Part Number	Page	Type	Part Number	Page
RC610	1SNA233114R1300	136	RC610	1SNA233238R0700	138	RC65	1SNA232117R1500	148
RC610	1SNA233115R1400	136	RC610	1SNA233239R0000	138	RC65	1SNA232118R2600	148
RC610	1SNA233116R1500	136	RC610	1SNA233240R1500	137	RC65	1SNA232119R2700	148
RC610	1SNA233117R1600	136	RC610	1SNA233241R0200	137	RC65	1SNA232131R1300	148
RC610	1SNA233118R2700	136	RC610	1SNA233242R0300	137	RC65	1SNA232132R1400	148
RC610	1SNA233119R2000	136	RC610	1SNA233243R0400	137	RC65	1SNA232133R1500	148
RC610	1SNA233120R2500	134	RC610	1SNA233244R0500	137	RC65	1SNA232134R1600	148
RC610	1SNA233124R1500	138	RC610	1SNA233245R0600	137	RC65	1SNA232135R1700	148
RC610	1SNA233125R1600	138	RC610	1SNA233246R0700	137	RC65	1SNA232136R1000	148
RC610	1SNA233126R1700	138	RC610	1SNA233247R0000	137	RC65	1SNA232137R1100	148
RC610	1SNA233127R1000	138	RC610	1SNA233248R1100	137	RC65	1SNA232150R0200	148
RC610	1SNA233131R1400	136	RC610	1SNA233250R1700	137	RC65	1SNA232151R2700	148
RC610	1SNA233132R1500	136	RC610	1SNA233251R0400	137	RC65	1SNA232152R2000	148
RC610	1SNA233133R1600	135	RC610	1SNA233252R0500	137	RC65	1SNA232153R2100	148
RC610	1SNA233134R1700	135	RC610	1SNA233253R0600	137	RC65	1SNA232154R2200	148
RC610	1SNA233135R1000	135	RC610	1SNA233254R0700	137	RC65	1SNA232155R2300	148
RC610	1SNA233136R1100	135	RC610	1SNA233255R0000	137	RC65	1SNA232156R2400	148
RC610	1SNA233137R1200	135	RC610	1SNA233256R0100	137	RC65	1SNA232157R2500	148
RC610	1SNA233141R2600	135	RC610	1SNA233257R0200	137	RC65	1SNA232158R0600	148
RC610	1SNA233142R2700	135	RC610	1SNA233258R1300	137	RC65	1SNA232159R0700	148
RC610	1SNA233143R2000	138	RC610	1SNA233259R1400	137	RC65	1SNA232160R0400	148
RC610	1SNA233144R2100	138	RC610	1SNA233260R1100	137	RC65	1SNA232161R2100	148
RC610	1SNA233145R2200	138	RC610TT	1SNA233600R1700	17	RC65	1SNA232162R2200	148
RC610	1SNA233146R2300	138	RC610TT-YL	1SNA233700R1300	17	RC65	1SNA232163R2300	148
RC610	1SNA233147R2400	138	RC65	1SNA103775R0000	86	RC65	1SNA232164R2400	148
RC610	1SNA233150R0300	136	RC65	1SNA103776R0100	86	RC65	1SNA232165R2500	148
RC610	1SNA233151R2000	136	RC65	1SNA232000R0000	86	RC65	1SNA232166R2600	148
RC610	1SNA233152R2100	136	RC65	1SNA232001R2500	147	RC65	1SNA232167R2700	148
RC610	1SNA233153R2200	136	RC65	1SNA232002R2600	147	RC65	1SNA232168R0000	148
RC610	1SNA233154R2300	136	RC65	1SNA232003R2700	147	RC65	1SNA232169R0100	148
RC610	1SNA233155R2400	136	RC65	1SNA232004R2000	147	RC65	1SNA232170R0600	148
RC610	1SNA233156R2500	136	RC65	1SNA232005R2100	147	RC65	1SNA232171R2300	148
RC610	1SNA233157R2600	136	RC65	1SNA232006R2200	147	RC65	1SNA232172R2400	148
RC610	1SNA233158R0700	136	RC65	1SNA232007R2300	147	RC65	1SNA232173R2500	148
RC610	1SNA233159R0000	136	RC65	1SNA232008R0400	147	RC65	1SNA232174R2600	148
RC610	1SNA233160R0500	136	RC65	1SNA232009R0500	147	RC65	1SNA232175R2700	148
RC610	1SNA233161R2200	136	RC65	1SNA232010R2100	147	RC65	1SNA232180R2100	150
RC610	1SNA233162R2300	136	RC65	1SNA232011R1600	147	RC65	1SNA232181R1600	150
RC610	1SNA233163R2400	136	RC65	1SNA232012R1700	147	RC65	1SNA232182R1700	150
RC610	1SNA233164R2500	136	RC65	1SNA232013R1000	147	RC65	1SNA232183R1000	150
RC610	1SNA233165R2600	136	RC65	1SNA232014R1100	147	RC65	1SNA232184R1100	150
RC610	1SNA233166R2700	136	RC65	1SNA232015R1200	147	RC65	1SNA232185R1200	150
RC610	1SNA233167R2000	136	RC65	1SNA232016R1300	147	RC65	1SNA232186R1300	150
RC610	1SNA233168R0100	136	RC65	1SNA232017R1400	147	RC65	1SNA232187R1400	150
RC610	1SNA233169R0200	136	RC65	1SNA232018R2500	147	RC65	1SNA232188R2500	150
RC610	1SNA233170R0700	136	RC65	1SNA232019R2600	147	RC65	1SNA232189R2600	150
RC610	1SNA233171R2400	136	RC65	1SNA232020R2300	147	RC65	1SNA232190R2300	150
RC610	1SNA233172R2500	136	RC65	1SNA232021R1000	147	RC65	1SNA232191R1000	150
RC610	1SNA233173R2600	136	RC65	1SNA232030R2500	147	RC65	1SNA232192R1100	150
RC610	1SNA233174R2700	136	RC65	1SNA232031R1200	147	RC65	1SNA232193R1200	150
RC610	1SNA233175R2000	136	RC65	1SNA232032R1300	147	RC65	1SNA232194R1300	150
RC610	1SNA233180R2200	138	RC65	1SNA232033R1400	147	RC65	1SNA232195R1400	150
RC610	1SNA233181R1700	138	RC65	1SNA232034R1500	147	RC65	1SNA232196R1500	150
RC610	1SNA233182R1000	138	RC65	1SNA232035R1600	147	RC65	1SNA232197R1600	150
RC610	1SNA233183R1100	138	RC65	1SNA232036R1700	147	RC65	1SNA232198R2700	150
RC610	1SNA233184R1200	138	RC65	1SNA232037R1000	147	RC65	1SNA232199R2000	150
RC610	1SNA233185R1300	138	RC65	1SNA232038R2100	147	RC65	1SNA232200R1500	150
RC610	1SNA233186R1400	138	RC65	1SNA232039R2200	147	RC65	1SNA232201R0200	147
RC610	1SNA233187R1500	138	RC65	1SNA232040R0700	149	RC65	1SNA232202R0300	147
RC610	1SNA233188R2600	138	RC65	1SNA232041R2400	149	RC65	1SNA232203R0400	147
RC610	1SNA233189R2700	138	RC65	1SNA232042R2500	149	RC65	1SNA232204R0500	147
RC610	1SNA233190R2400	138	RC65	1SNA232043R2600	149	RC65	1SNA232205R0600	147
RC610	1SNA233191R1100	138	RC65	1SNA232044R2700	149	RC65	1SNA232206R0700	147
RC610	1SNA233192R1200	138	RC65	1SNA232045R2000	149	RC65	1SNA232207R0000	147
RC610	1SNA233193R1300	138	RC65	1SNA232046R2100	149	RC65	1SNA232208R1100	147
RC610	1SNA233194R1400	138	RC65	1SNA232047R2200	149	RC65	1SNA232209R1200	147
RC610	1SNA233195R1500	138	RC65	1SNA232048R0300	149	RC65	1SNA232211R2300	147
RC610	1SNA233196R1600	138	RC65	1SNA232049R0400	149	RC65	1SNA232212R2400	147
RC610	1SNA233197R1700	138	RC65	1SNA232050R0100	149	RC65	1SNA232213R2500	147
RC610	1SNA233198R2000	138	RC65	1SNA232051R2600	149	RC65	1SNA232214R2600	147
RC610	1SNA233199R2100	138	RC65	1SNA232052R2700	149	RC65	1SNA232215R2700	147
RC610	1SNA233200R1600	138	RC65	1SNA232053R2000	149	RC65	1SNA232216R2000	147
RC610	1SNA233201R0300	135	RC65	1SNA232054R2100	149	RC65	1SNA232217R2100	147
RC610	1SNA233202R0400	135	RC65	1SNA232055R2200	149	RC65	1SNA232218R0200	147
RC610	1SNA233203R0500	135	RC65	1SNA232056R2300	149	RC65	1SNA232219R0300	147
RC610	1SNA233204R0600	135	RC65	1SNA232057R2400	149	RC65	1SNA232220R0000	147
RC610	1SNA233205R0700	135	RC65	1SNA232058R0500	149	RC65	1SNA232221R2500	147
RC610	1SNA233206R0000	135	RC65	1SNA232059R0600	149	RC65	1SNA232235R2300	150
RC610	1SNA233207R0100	135	RC65	1SNA232060R0300	149	RC65	1SNA232236R2400	150
RC610	1SNA233208R1200	135	RC65	1SNA232061R2000	149	RC65	1SNA232237R2500	150
RC610	1SNA233209R1300	135	RC65	1SNA232062R2100	149	RC65	1SNA232238R0600	150
RC610	1SNA233211R2400	135	RC65	1SNA232063R2200	149	RC65	1SNA232239R0700	150
RC610	1SNA233212R2500	135	RC65	1SNA232064R2300	149	RC65	1SNA232240R1400	149
RC610	1SNA233213R2600	135	RC65	1SNA232065R2400	149	RC65	1SNA232241R0100	149
RC610	1SNA233214R2700	135	RC65	1SNA232066R2500	149	RC65	1SNA232242R0200	149
RC610	1SNA233215R2000	135	RC65	1SNA232067R2600	149	RC65	1SNA232243R0300	149
RC610	1SNA233216R2100	135	RC65	1SNA232068R0700	149	RC65	1SNA232244R0400	149
RC610	1SNA233217R2200	135	RC65	1SNA232069R0000	149	RC65	1SNA232245R0500	149
RC610	1SNA233218R0300	135	RC65	1SNA232072R2300	149	RC65	1SNA232246R0600	149
RC610	1SNA233219R0400	135	RC65	1SNA232111R1700	148	RC65	1SNA232247R0700	149
RC610	1SNA233220R0100	135	RC65	1SNA232112R1000	148	RC65	1SNA232248R1000	149
RC610	1SNA233221R2600	135	RC65	1SNA232113R1100	148	RC65	1SNA232250R1600	149
RC610	1SNA233235R2400	138	RC65	1SNA232114R1200	148	RC65	1SNA232251R0300	149
RC610	1SNA233236R2500	138	RC65	1SNA232115R1300	148	RC65	1SNA232252R0400	149
RC610	1SNA233237R2600	138	RC65	1SNA232116R1400	148	RC65	1SNA232253R0500	149

Index

Type classification

Type	Part Number	Page	Type	Part Number	Page	Type	Part Number	Page
RC65	1SNA232254R0600	149	RC810	1SNA234168R0200	140	RCAL85	1SNA237086R1700	152
RC65	1SNA232255R0700	149	RC810	1SNA234169R0300	140	RCAL85	1SNA237087R1000	152
RC65	1SNA232256R0000	149	RC810	1SNA234170R0000	140	RCAL85	1SNA237088R2100	152
RC65	1SNA232257R0100	149	RC810	1SNA234171R2500	140	RCAL85	1SNA237131R1000	151
RC65	1SNA232258R1200	149	RC810	1SNA234172R2600	140	RCAL85	1SNA237132R1100	151
RC65	1SNA232259R1300	149	RC810	1SNA234173R2700	140	RCCV	1SNA235460R0400	103
RC65	1SNA232260R1000	149	RC810	1SNA234174R2000	140	RCL510	1SNA235097R1000	18
RC810	1SNA234000R0200	85	RC810	1SNA234175R2100	140	RCP510	1SNA235095R1600	18
RC810	1SNA234001R2700	139	RC810	1SNA234180R2300	141	RCPEAD	1SNA399725R0600	94
RC810	1SNA234002R2000	139	RC810	1SNA234181R1000	141	RCPEAD-TT	1SNA235158R0100	22
RC810	1SNA234003R2100	139	RC810	1SNA234182R1100	141	RCPEAD-TT-YL	1SNA235159R0200	22
RC810	1SNA234004R2200	139	RC810	1SNA234183R1200	141	RCPEB	1SNA178430R0500	96
RC810	1SNA234005R2300	139	RC810	1SNA234184R1300	141	RCT610	1SNA236000R0400	87
RC810	1SNA234006R2400	139	RC810	1SNA234185R1400	141	RCT610	1SNA236001R2100	153
RC810	1SNA234007R2500	139	RC810	1SNA234186R1500	141	RCT810	1SNA236500R0600	87
RC810	1SNA234008R0600	139	RC810	1SNA234187R1600	141	RCT810	1SNA236501R2300	153
RC810	1SNA234009R0700	139	RC810	1SNA234188R2700	141	RCW510	1SNA235096R1700	18
RC810	1SNA234010R2300	139	RC810	1SNA234189R2000	141	REH3	1SNA163155R2600	91
RC810	1SNA234011R1000	139	RC810	1SNA234190R2500	141	REH3	1SNA163167R2200	155
RC810	1SNA234012R1100	139	RC810	1SNA234191R1200	141	REH3	1SNA164695R2500	155
RC810	1SNA234013R1200	139	RC810	1SNA234192R1300	141	RIB-B	1SNA235710R0600	12
RC810	1SNA234014R1300	139	RC810	1SNA234193R1400	141	RIB-R	1SNA235711R2300	12
RC810	1SNA234015R1400	139	RC810	1SNA234194R1500	141	RIB-RS	1SNA235718R0200	12
RC810	1SNA234016R1500	139	RC810	1SNA234195R1600	141	RING1210	1SNA235120R2700	27
RC810	1SNA234017R1600	139	RC810	1SNA234196R1700	141	RING122	1SNA235117R1000	27
RC810	1SNA234018R2700	139	RC810	1SNA234197R1000	141	RING124	1SNA235118R2100	27
RC810	1SNA234019R2000	139	RC810	1SNA234198R2100	141	RING127	1SNA235119R2200	27
RC810	1SNA234020R2500	139	RC810	1SNA234199R2200	141	RING1810	1SNA235126R1100	27
RC810	1SNA234021R1200	139	RC810	1SNA234200R1700	141	RING182	1SNA235123R1600	27
RC810	1SNA234030R2700	139	RC810	1SNA234201R0400	141	RING184	1SNA235124R1700	27
RC810	1SNA234031R1400	139	RC810	1SNA234202R0500	141	RING187	1SNA235125R1000	27
RC810	1SNA234032R1500	139	RC810	1SNA234203R0600	141	RINGT209	1SNA235142R2100	28
RC810	1SNA234033R1600	139	RC810	1SNA234204R0700	141	RINGT23	1SNA235137R1400	27
RC810	1SNA234034R1700	139	RC810	1SNA234205R0000	141	RPA	1SNA235463R2300	104
RC810	1SNA234035R1000	139	RC810TT	1SNA234600R1000	17	RPA-TT	1SNA235151R2200	30
RC810	1SNA234036R1100	139	RC810TT-YL	1SNA234700R1400	17	RPA-TT-YL	1SNA235152R2300	30
RC810	1SNA234037R1200	139	RCAL85	1SNA234000R0500	86	RPEH	1SNA163007R2600	95
RC810	1SNA234038R2300	139	RCAL85	1SNA237001R2200	151	RPEV	1SNA173178R0700	89
RC810	1SNA234039R2400	139	RCAL85	1SNA237002R2300	151	RTA-TAP 990453N	1SNB990453R0000	69
RC810	1SNA234040R0100	141	RCAL85	1SNA237003R2400	151	RTA-TAP 990455N	1SNB990455R0000	69
RC810	1SNA234041R2600	141	RCAL85	1SNA237004R2500	151	RTA-TAPW 990653N	1SNB990653R0000	70
RC810	1SNA234042R2700	141	RCAL85	1SNA237005R2600	151	RT-CCP 990456	1SNB990456R0000	69
RC810	1SNA234043R2000	141	RCAL85	1SNA237006R2700	151	RTM7	1SNA103115R1300	154
RC810	1SNA234044R2100	141	RCAL85	1SNA237007R2000	151	RTM7	1SNA103116R1400	154
RC810	1SNA234045R2200	141	RCAL85	1SNA237008R0100	151	RTM7	1SNA103922R1400	154
RC810	1SNA234046R2300	141	RCAL85	1SNA237009R0200	151	RTM7	1SNA168410R0700	90
RC810	1SNA234047R2400	141	RCAL85	1SNA237010R2600	151	RTM9	1SNA164602R0000	90
RC810	1SNA234048R0500	141	RCAL85	1SNA237011R1300	151	RTR-TAP 990452	1SNB990452R0000	69
RC810	1SNA234049R0600	141	RCAL85	1SNA237012R1400	151	RTR-TAP 990454	1SNB990454R0000	69
RC810	1SNA234050R0300	141	RCAL85	1SNA237013R1500	151	SERVICE KIT FOR AMS 500	1SNA3600162R1600	81
RC810	1SNA234051R2000	141	RCAL85	1SNA237014R1600	151	SNAP1510	1SNA235132R1700	27
RC810	1SNA234052R2100	141	RCAL85	1SNA237015R1700	151	SNAP152	1SNA235129R2400	27
RC810	1SNA234053R2200	141	RCAL85	1SNA237016R1000	151	SNAP154	1SNA235130R2100	27
RC810	1SNA234054R2300	141	RCAL85	1SNA237017R1100	151	SNAP157	1SNA235131R1600	27
RC810	1SNA234055R2400	141	RCAL85	1SNA237018R2200	151	SNAP2310	1SNA235136R1300	27
RC810	1SNA234056R2500	141	RCAL85	1SNA237019R2300	151	SNAP232	1SNA235133R1000	27
RC810	1SNA234057R2600	141	RCAL85	1SNA237020R2000	151	SNAP234	1SNA235134R1100	27
RC810	1SNA234058R0700	141	RCAL85	1SNA237021R1500	151	SNAP237	1SNA235135R1200	27
RC810	1SNA234059R0000	141	RCAL85	1SNA237030R2200	151	SPDST1	1SNA360163R1700	81
RC810	1SNA234060R0500	141	RCAL85	1SNA237031R1700	151	SPRC 1	1SNA360010R1500	81
RC810	1SNA234061R2200	141	RCAL85	1SNA237032R1000	151	SPRC 10	1SNA360020R1700	81
RC810	1SNA234062R2300	141	RCAL85	1SNA237033R1100	151	SPRC 11	1SNA360021R0400	81
RC810	1SNA234063R2400	141	RCAL85	1SNA237034R1200	151	SPRC 13	1SNA360023R0600	81
RC810	1SNA234064R2500	141	RCAL85	1SNA237035R1300	151	SPRC 14	1SNA360024R0700	81
RC810	1SNA234065R2600	141	RCAL85	1SNA237036R1400	151	SPRC 15	1SNA360025R0000	81
RC810	1SNA234066R2700	141	RCAL85	1SNA237040R0400	152	SPRC 16	1SNA360026R0100	81
RC810	1SNA234067R2000	141	RCAL85	1SNA237041R2100	152	SPRC 2	1SNA360011R1500	81
RC810	1SNA234068R0100	141	RCAL85	1SNA237042R2200	152	SPRC 21	1SNA360031R0600	81
RC810	1SNA234069R0200	141	RCAL85	1SNA237043R2300	152	SPRC 26	1SNA360036R0300	81
RC810	1SNA234072R2500	140	RCAL85	1SNA237044R2400	152	SPRC 27	1SNA360037R0400	81
RC810	1SNA234111R1100	140	RCAL85	1SNA237045R2500	152	SPRC 28	1SNA360040R2300	81
RC810	1SNA234112R1200	140	RCAL85	1SNA237046R2600	152	SPRC 29	1SNA360038R1500	81
RC810	1SNA234113R1300	140	RCAL85	1SNA237047R2700	152	SPRC 30-3	1SNA360039R1700	81
RC810	1SNA234114R1400	140	RCAL85	1SNA237048R0000	152	SPRC 4	1SNA360014R0500	81
RC810	1SNA234115R1500	140	RCAL85	1SNA237049R0100	152	SPRC 5	1SNA360015R0600	81
RC810	1SNA234116R1600	140	RCAL85	1SNA237050R0600	152	SPRC 6	1SNA360016R0700	81
RC810	1SNA234130R2000	139	RCAL85	1SNA237051R2300	152	SPRC 7	1SNA360017R0000	81
RC810	1SNA234150R0400	140	RCAL85	1SNA237060R0000	152	SPRC 8	1SNA360018R1100	81
RC810	1SNA234151R2100	140	RCAL85	1SNA237061R2500	152	SPRC 9	1SNA360019R1200	81
RC810	1SNA234152R2200	140	RCAL85	1SNA237062R2600	152	SPRC 9	1SNA360011R0200	103
RC810	1SNA234153R2300	140	RCAL85	1SNA237063R2700	152	UMH	1SNK900611R0000	58
RC810	1SNA234154R2400	140	RCAL85	1SNA237064R2000	152	VSP12	1SNA163432R1400	157
RC810	1SNA234155R2500	140	RCAL85	1SNA237065R2100	152	VSP16	1SNA173147R2000	157
RC810	1SNA234156R2600	140	RCAL85	1SNA237066R2200	152	VSP22	1SNA400252R1200	157
RC810	1SNA234157R2700	140	RCAL85	1SNA237067R2300	152	VSP6	1SNA163433R1500	157
RC810	1SNA234158R0000	140	RCAL85	1SNA237068R0400	152	VSP68	1SNA206103R0700	157
RC810	1SNA234159R0100	140	RCAL85	1SNA237074R2200	151	WM12	1SNA235148R0700	100
RC810	1SNA234160R0600	140	RCAL85	1SNA237075R2300	151	WM18	1SNA235149R0000	100
RC810	1SNA234161R2300	140	RCAL85	1SNA237076R2400	151	WMTT12	1SNA235093R1400	26
RC810	1SNA234162R2400	140	RCAL85	1SNA237080R2500	152	WMTT18	1SNA235094R1500	26
RC810	1SNA234163R2500	140	RCAL85	1SNA237081R1200	152			
RC810	1SNA234164R2600	140	RCAL85	1SNA237082R1300	152			
RC810	1SNA234165R2700	140	RCAL85	1SNA237083R1400	152			
RC810	1SNA234166R2000	140	RCAL85	1SNA237084R1500	152			
RC810	1SNA234167R2100	140	RCAL85	1SNA237085R1600	152			





EASY RAIL DESIGNER 3D

TERMINAL BLOCK
ASSEMBLY SOFTWARE

ENTRELEC Terminal Blocks

EASY RAIL DESIGNER 3D

From engineering to assembling

**ENGINEERING,
DO IT YOURSELF EASILY**



Speed up your projects
Simplify the design process

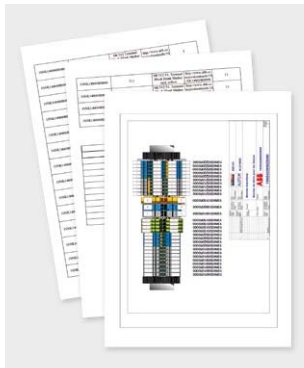
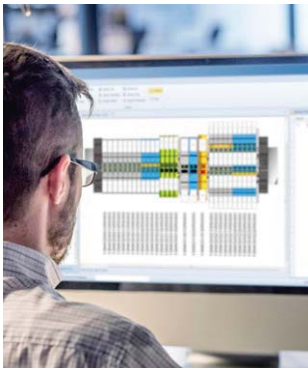

Advanced 3D drawing and data export

- Built-in 3D viewer
- Integration to CAD/CAE softwares
- Compatibility with TE printers
- Detailed drawings of the rail, assembly and markers.

Customized project management

- Management of multiple projects
- Indication on the drawing of the supplier's, integrator's and end user's data
- Drawing update indexing with PDF report.

User-friendly configurator

- Intuitive Windows® (1) user interface
- Autocorrecting system
- Powerful search engine
- Insertion of products external to the database.

(1) Windows® is a registered trademark of Microsoft.

ASSEMBLING, RELY ON TE EXPERTISE



Cost effective solution

Up to 20% of material cost reduction



TE technical expertise

- Drawing technical verification done by TE experts
- 100% reliable data import to TE production system.

Flexible production

- 3 types of assembly:
 - rail mounted
 - pre-assembled
 - packed in kit.
- Possibility to add some other TE Din rail products.

Optimized inventory

- Products and markers stocked by TE
- Marking managed by TE
- One single product part number corresponds to one complete assembly.

EASY RAIL DESIGNER 3D

User-oriented features

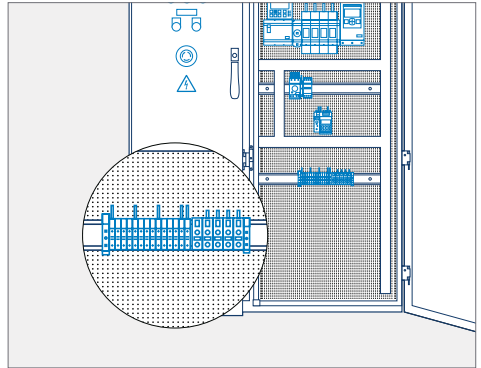
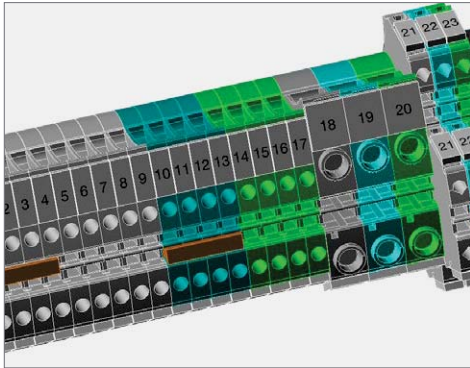

3D drawing

- Built-in 3D viewer
- 3D drawing export.

CAD/CAE integration

- Export to the main CAD/CAE softwares.

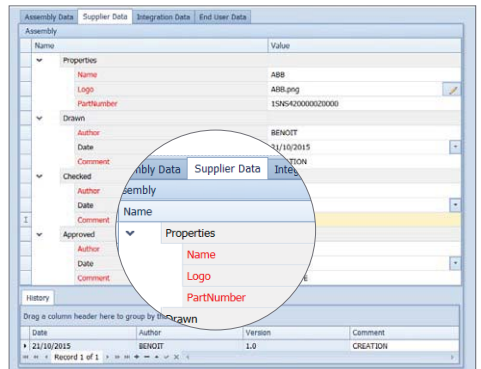
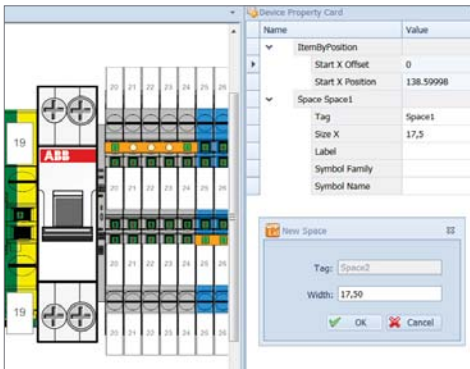

Complementary products

- Insertion of products and components (diode, resistor) external to the database.

Customization

- Indication on the drawing of the supplier's, integrator's and end user's name, logotype and part number.

LET'S CONNECT

We make it easy to connect with our experts and are ready to provide all the support you need. For additional information or product assistance, please contact your field representative or our customer service department. Additional information is also available on the website <http://www.te.com/entrelec>.

TECHNICAL SUPPORT

te.com/support-center

Asia:

+86 400-820-6015

Europe, Middle East, & Africa:

+49 6251-133-0

North America:

+1-888-441-9982

te.com

ENTRELEC, TE Connectivity, TE Connectivity (logo) and Every Connection Counts are trademarks. All other logos, products and/or company names referred to herein might be trademarks of their respective owners.

All other logos, products and/or company names referred to herein might be trademarks of their respective owners.

The information given herein, including drawings, illustrations and schematics which are intended for illustration purposes only, is believed to be reliable. However, TE Connectivity makes no warranties as to its accuracy or completeness and disclaims any liability in connection with its use. TE Connectivity's obligations shall only be as set forth in TE Connectivity's Standard Terms and Conditions of Sale for this product and in no case will TE Connectivity be liable for any incidental, indirect or consequential damages arising out of the sale, resale, use or misuse of the product. Users of TE Connectivity products should make their own evaluation to determine the suitability of each such product for the specific application.

© 2018 TE Connectivity Ltd. family of companies All Rights Reserved.

1-1773980-7 07/19 - Printed in France (PDF)

TE Connectivity

3, rue Jean Perrin
69687 Chassieu cedex
France

Tel: +33 472172222

www.te.com/